



US00D966834S

(12) **United States Design Patent**  
**Nishida**

(10) **Patent No.:** **US D966,834 S**

(45) **Date of Patent:** **\*\* Oct. 18, 2022**

(54) **PERFORATED SPOON**

(71) Applicant: **Shigeru Nishida**, Ridgewood, NJ (US)

(72) Inventor: **Shigeru Nishida**, Ridgewood, NJ (US)

(\*\*) Term: **15 Years**

(21) Appl. No.: **29/750,554**

(22) Filed: **Sep. 15, 2020**

(51) **LOC (13) Cl.** ..... **07-02**

(52) **U.S. Cl.**

USPC ..... **D7/692**; D7/653

(58) **Field of Classification Search**

USPC ..... D7/368, 393-395, 401.2, 444, 642-645,  
D7/683, 688-692, 653-660

CPC ..... A47G 21/04; A47J 43/281; A47J 43/284;  
A61B 17/08; A61B 13/00

See application file for complete search history.

(56) **References Cited**

**U.S. PATENT DOCUMENTS**

832,992	A	10/1906	Morgan	
1,057,269	A *	3/1913	Prestien	B26B 11/00
				30/325
D71,016	S *	9/1926	Hill	30/325
1,654,980	A *	1/1928	Le Duc	A47G 21/04
				210/469
2,083,299	A *	6/1937	Hunter	A47G 29/093
				248/500
2,572,524	A *	10/1951	Schmeiler	A47J 43/285
				30/325
2,923,059	A	2/1960	Campagna	
D194,402	S *	1/1963	Schlessel	30/325
3,286,346	A *	11/1966	Perry	A47J 17/04
				D7/693
3,768,477	A *	10/1973	Anders	A61C 17/08
				433/91
4,040,185	A *	8/1977	Jacobi	A47J 43/281
				210/474
4,438,564	A *	3/1984	Ashton	A47J 29/06
				30/325
4,825,551	A *	5/1989	Sherblom	A47J 43/281
				30/325

D325,327	S *	4/1992	Tam	D7/667
5,199,349	A *	4/1993	Hansen	A47J 43/284
				30/325
D343,996	S *	2/1994	Hansen	D7/692
D437,738	S *	2/2001	Durbin	D7/647
6,550,146	B1	4/2003	Rouleau	
D478,789	S *	8/2003	Shin	D7/662
D495,216	S	8/2004	Overthun	
D542,103	S *	5/2007	Yu	D7/688
D552,431	S *	10/2007	Chou	D7/653
D572,090	S *	7/2008	Miller	D7/653

(Continued)

**FOREIGN PATENT DOCUMENTS**

WO RGN D062856-014 \* 8/2002

**OTHER PUBLICATIONS**

JapanBargain 2384, Set of 4 Asian Japanese Chinese Wonton Soba Rice Pho Ramen Noodle Soup Spoons, Red/Black Online, published date Jul. 17, 2015. Retrieved on Jul. 22, 2022 from URL: [https://www.amazon.com/JapanBargain-Brand-Red-Chinese-Japanese-Wonton/dp/B011T1XJU6/ref=sr\\_1\\_1?keywords=wonton+soup+spoons&qid=1%E2%80%A6.\\*](https://www.amazon.com/JapanBargain-Brand-Red-Chinese-Japanese-Wonton/dp/B011T1XJU6/ref=sr_1_1?keywords=wonton+soup+spoons&qid=1%E2%80%A6.*)

*Primary Examiner* — Omeed Agilee  
*Assistant Examiner* — Royner Mendoza

(57) **CLAIM**

I claim the ornamental design for a perforated spoon, as shown and described.

**DESCRIPTION**

FIG. 1 is a right side view of a perforated spoon.  
FIG. 2 is a left side view of the claimed design.  
FIG. 3 is a front view of the claimed design.  
FIG. 4 is a rear view of the claimed design.  
FIG. 5 is a top view of the claimed design.  
FIG. 6 is a bottom view of the claimed design; and,  
FIG. 7 is a perspective view of the claimed design.

**1 Claim, 4 Drawing Sheets**

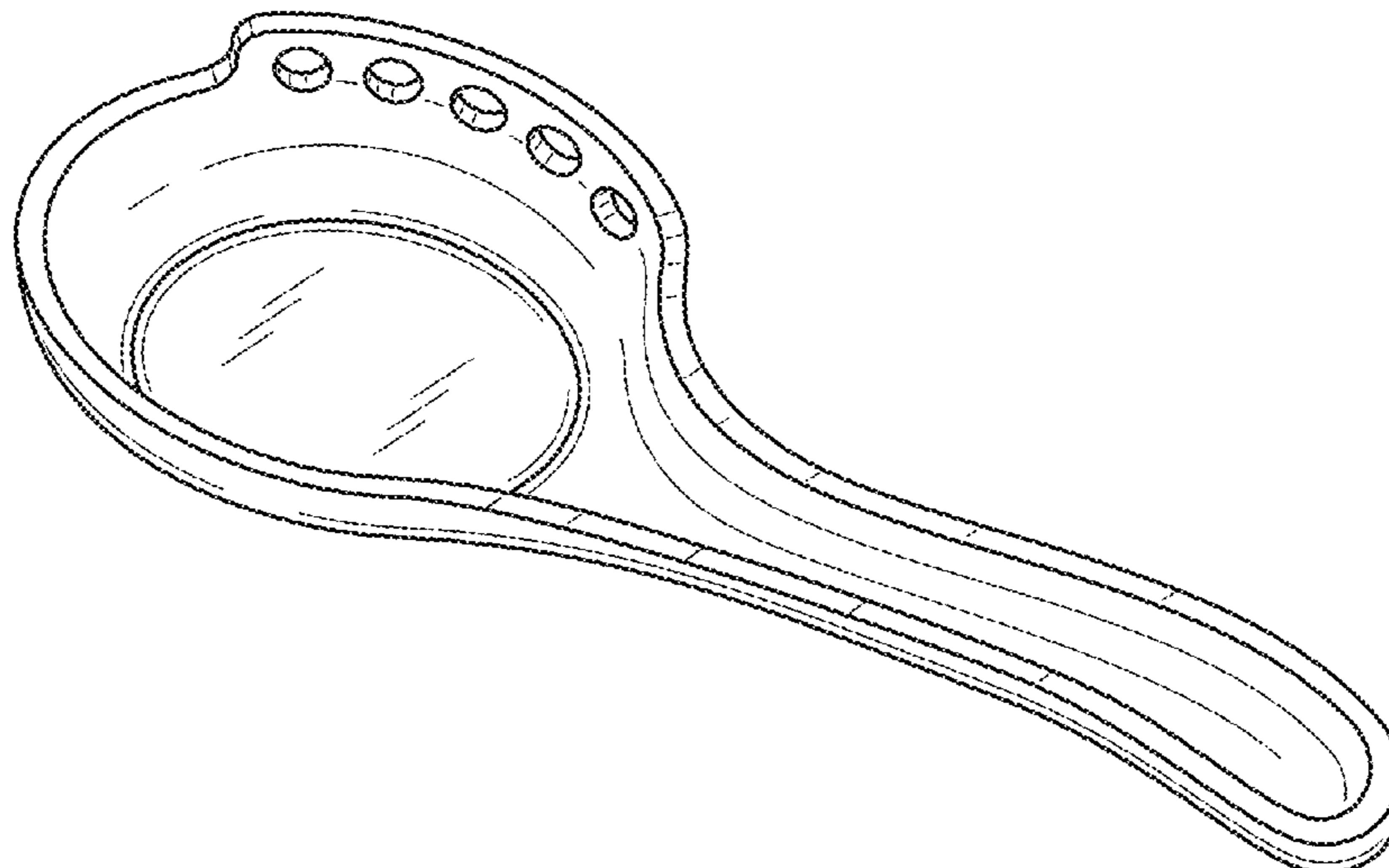

(56)

**References Cited**

U.S. PATENT DOCUMENTS

7,484,299	B1	2/2009	Fleming	
D948,971	S *	4/2022	Mack .....	D7/642
2013/0047445	A1 *	2/2013	Zheng .....	A47G 21/04 30/324
2017/0156526	A1	6/2017	Swanson	

\* cited by examiner

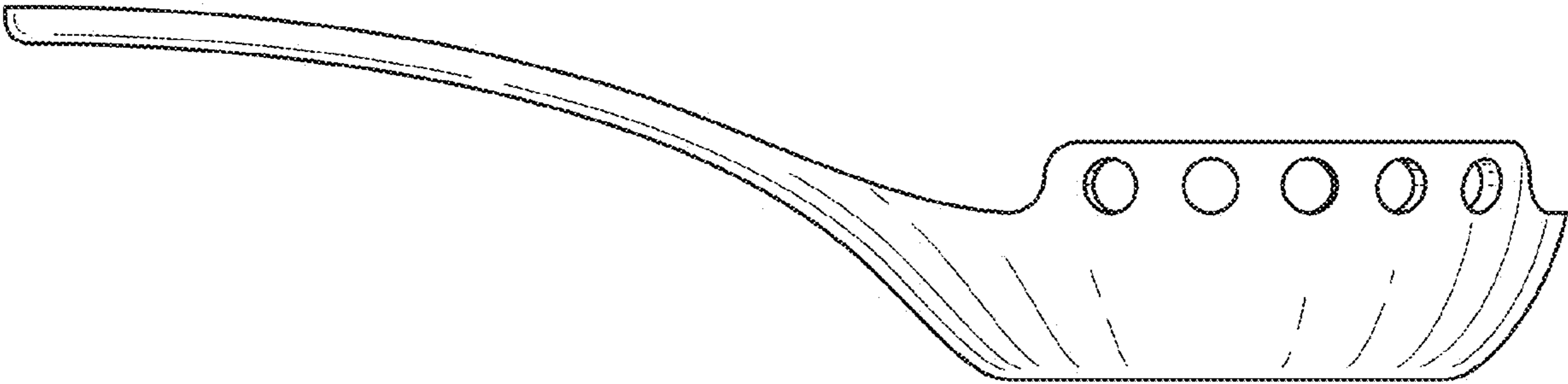

FIG. 1

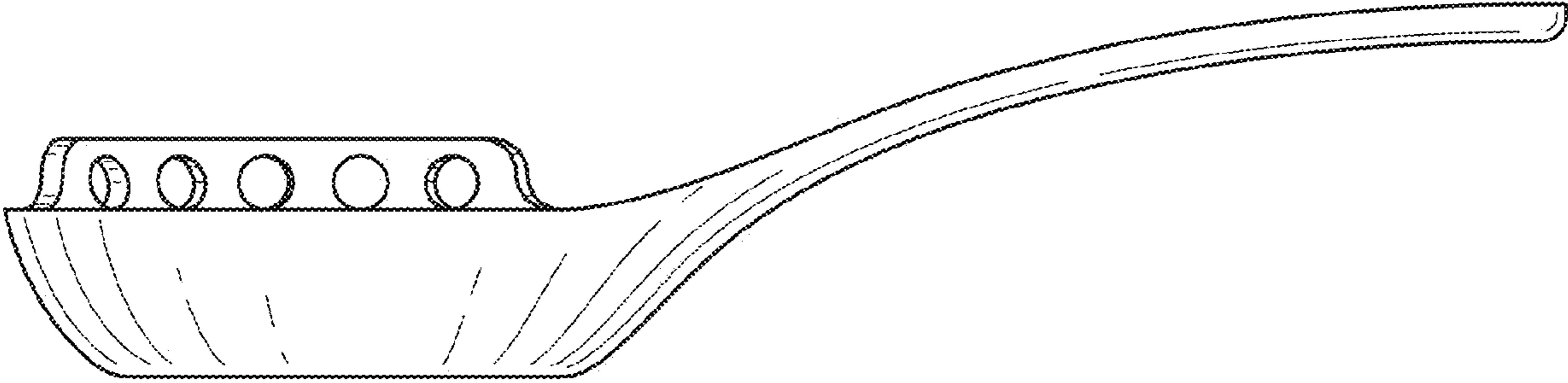

FIG. 2

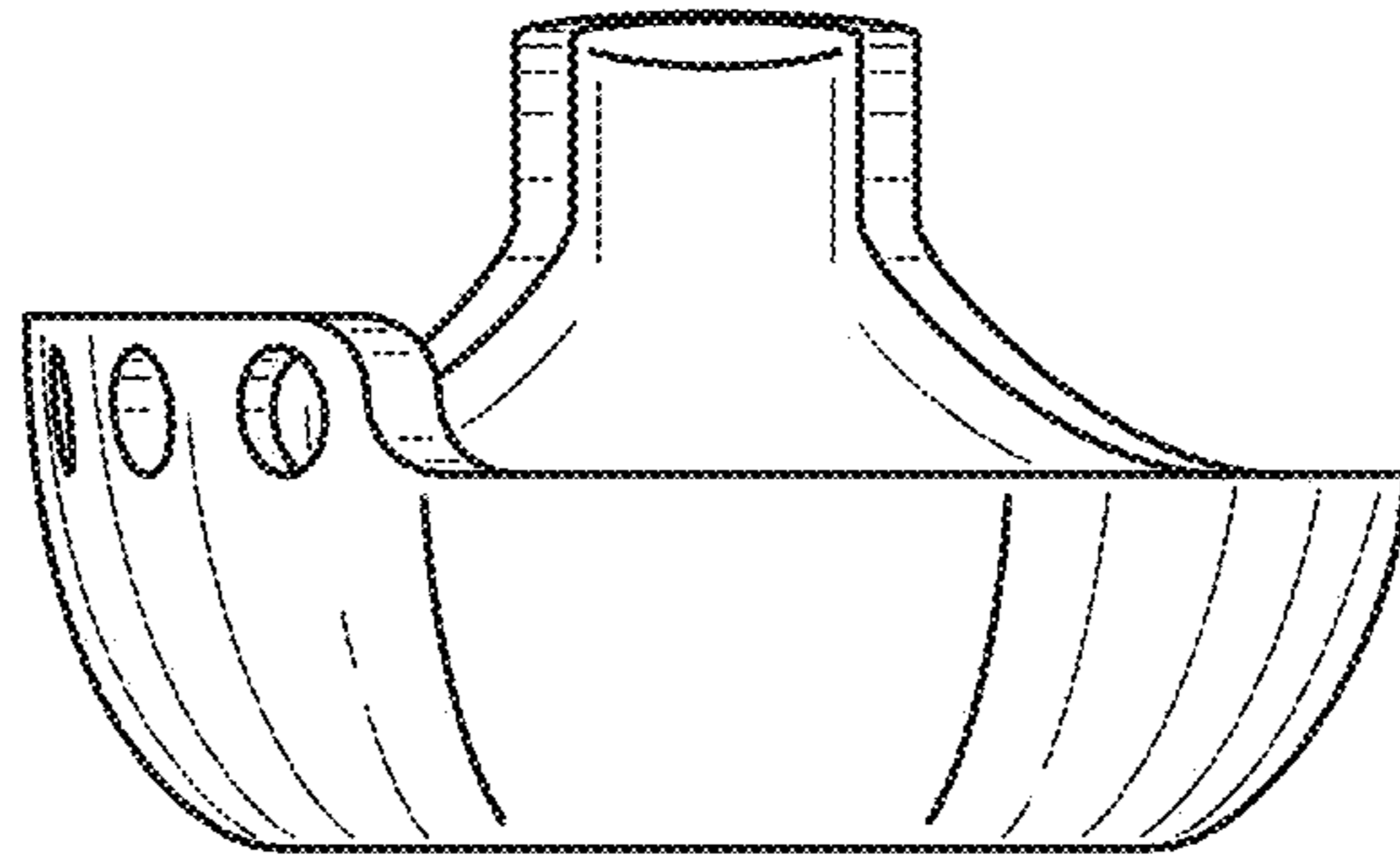

FIG. 3

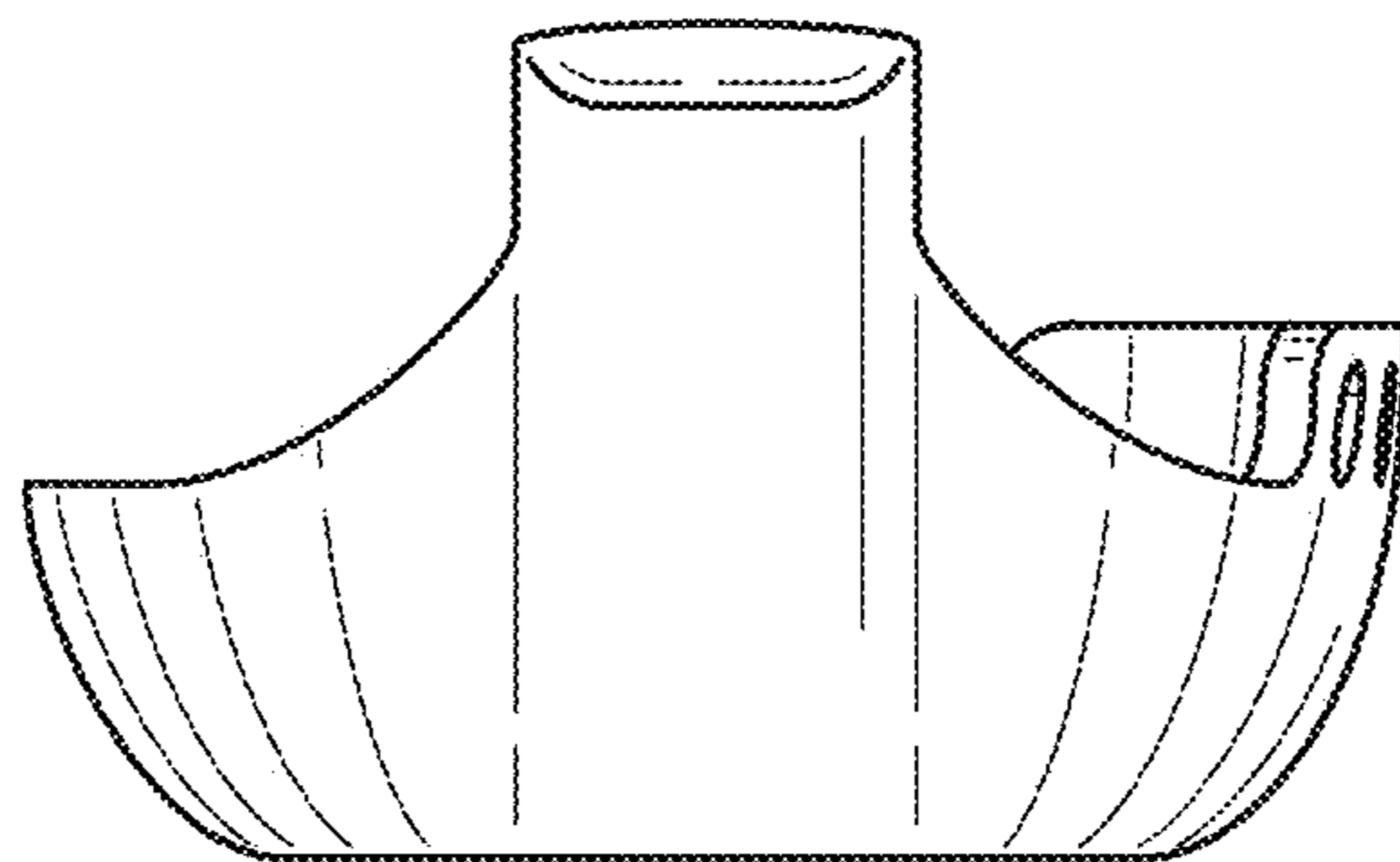

FIG. 4

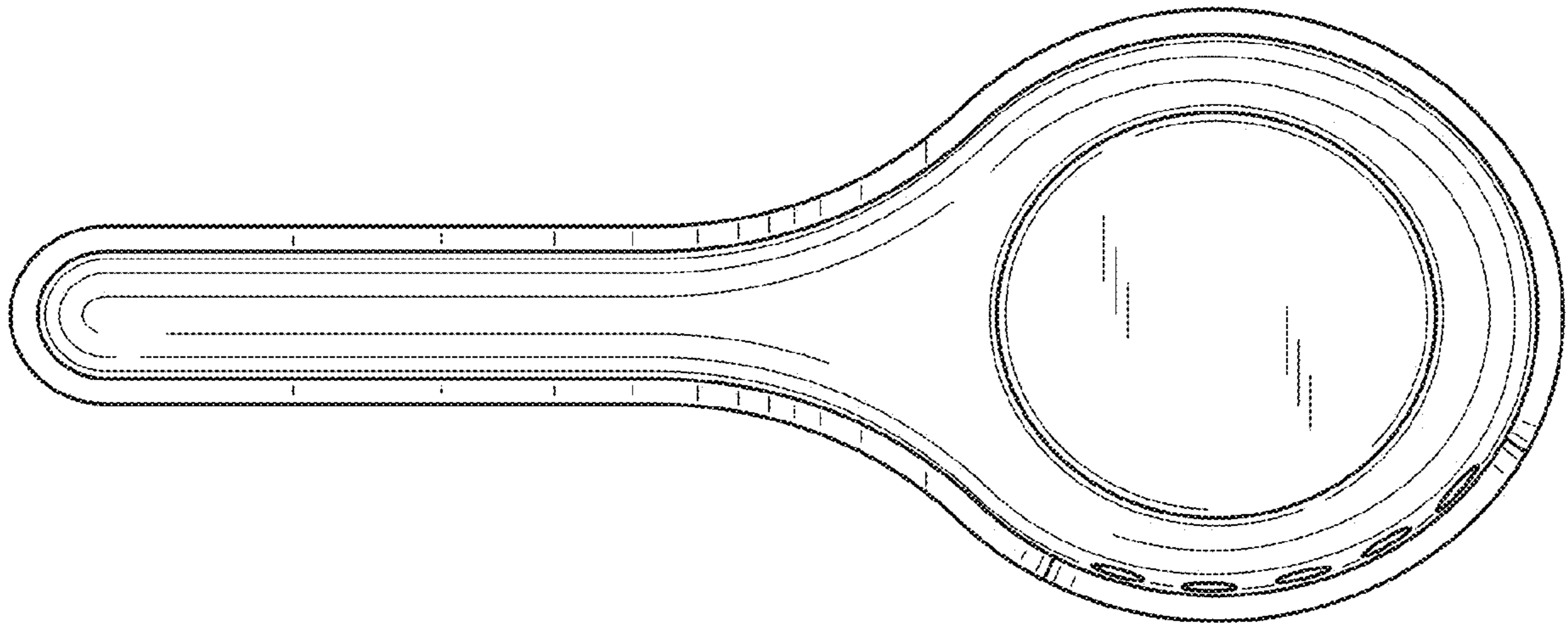

FIG. 5

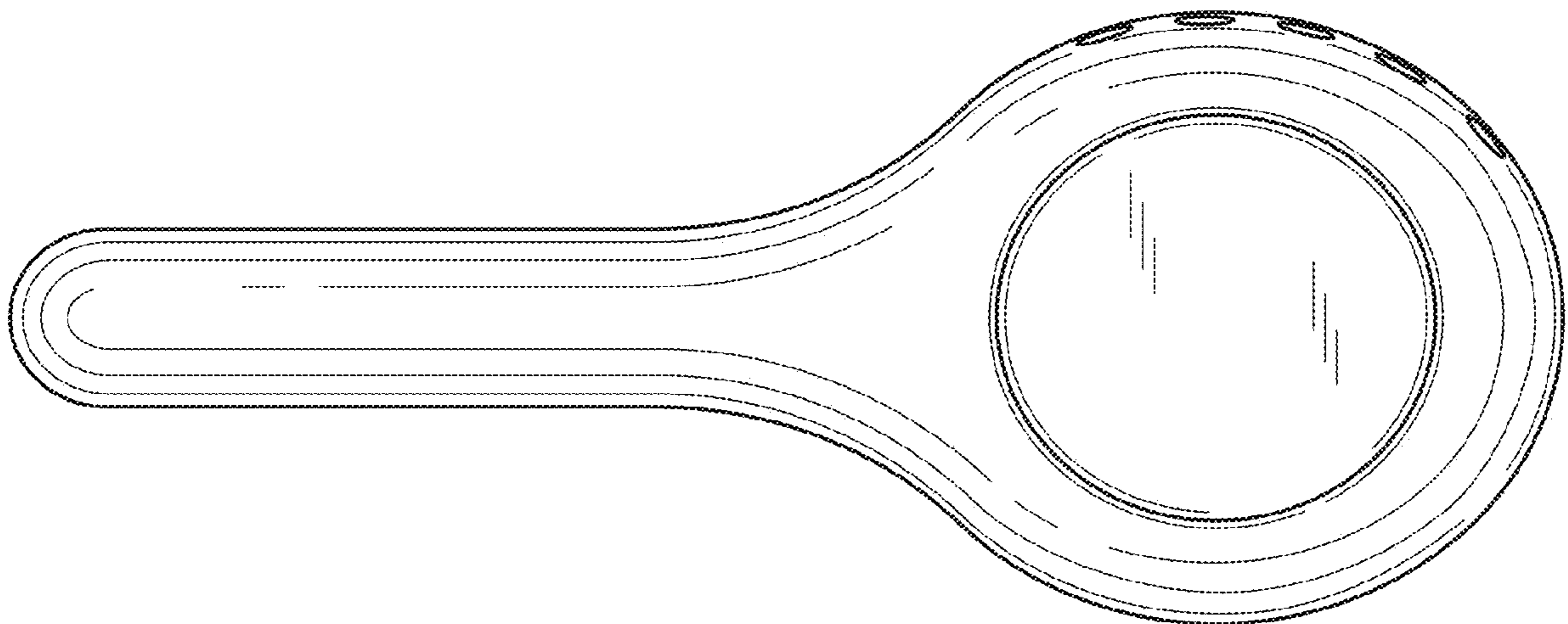

FIG. 6



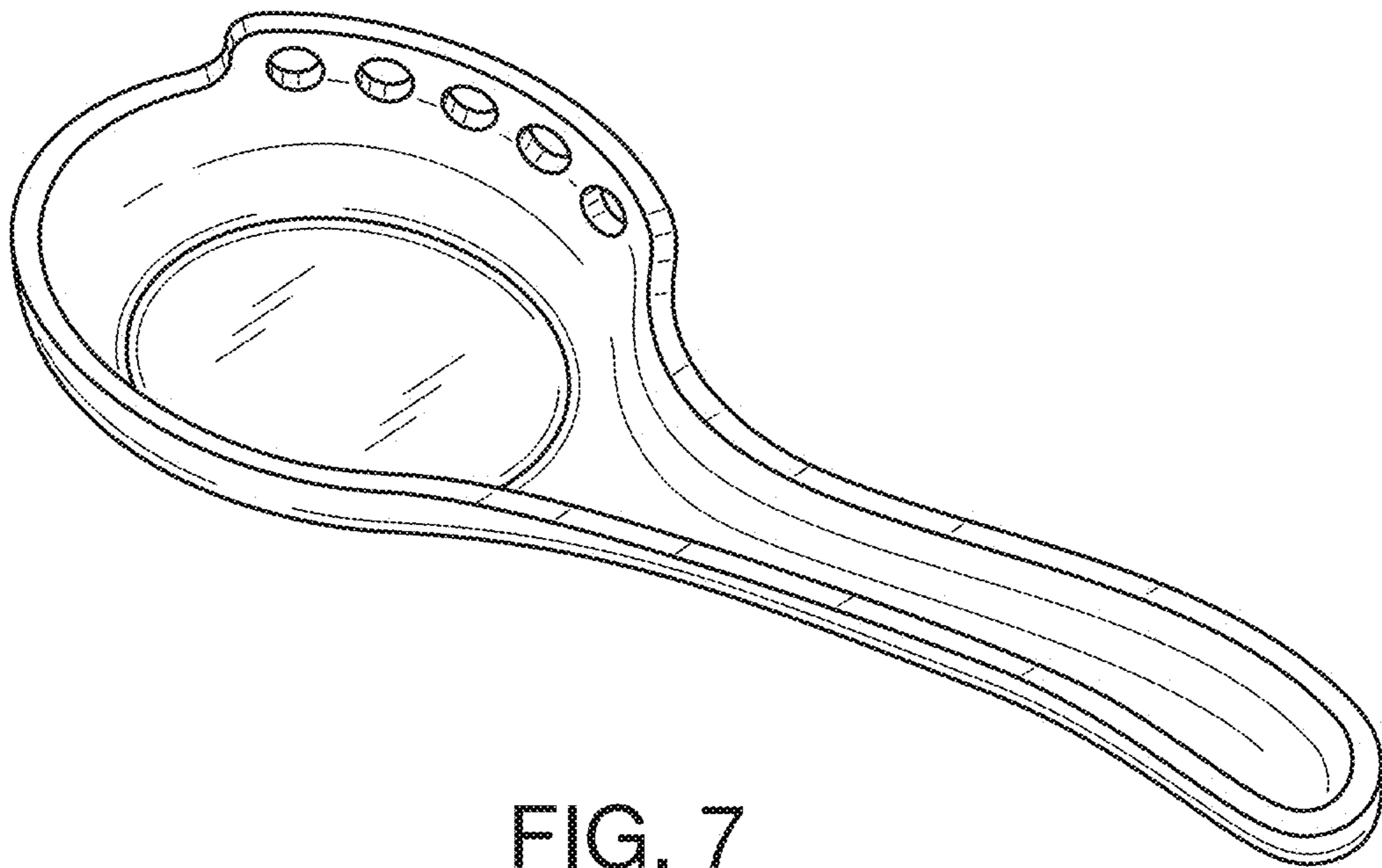

FIG. 7