



US00D966745S

(12) **United States Design Patent** (10) **Patent No.:** **US D966,745 S**
Liu (45) **Date of Patent:** **** Oct. 18, 2022**

(54) **BODY PILLOW**
(71) Applicant: **Zhuojia Liu**, Jiangsu (CN)
(72) Inventor: **Zhuojia Liu**, Jiangsu (CN)
(**) Term: **15 Years**

D431,745 S * 10/2000 Jackson D6/601
D449,482 S * 10/2001 Berke D6/601
D450,517 S * 11/2001 Darling D6/601
D453,653 S * 2/2002 Tunnell A47C 20/027
D6/601
6,499,164 B1 * 12/2002 Leach A47C 20/023
5/652

(Continued)

(21) Appl. No.: **29/820,074**
(22) Filed: **Dec. 20, 2021**
(51) **LOC (13) Cl.** **06-09**
(52) **U.S. Cl.**
USPC **D6/601**
(58) **Field of Classification Search**
USPC D6/595, 596, 597, 600, 601, 603, 604,
D6/605, 606, 608; D24/183, 185, 234;
D21/803, 804, 805, 809
CPC A47G 2009/1018; A47G 2009/003; A47G
9/0253; A47G 9/10; A47G 9/1027; A47G
9/1036; A47G 9/1054; A47G 9/1063;
A47G 9/1072; A47G 9/1081; A47G
9/109; A45F 4/06; A47C 21/06; A47C
7/18; A47C 20/00; A47C 17/80; A47C
17/82; A47C 17/64; A47C 27/00; A47C
27/14; A47C 23/00
See application file for complete search history.

FOREIGN PATENT DOCUMENTS

JP D1103740 * 3/2001

OTHER PUBLICATIONS

Google Term Search: 'Body Pillow', [site visited Aug. 26, 2022]
<URL: https://www.google.com/search?q=body+pillow&sxsrf=ALiCzsZnjeqBhsvq4uS8kPMLLpyEnsiFiA:1661647017657&source=lnms&tbn=isch&sa=X&ved=2ahUKEwjX1OrBpej5AhUnM1kFHSLFBdsQ_AUoAnoECAEQBA&biw=1920&bih=880&dpr=1> (Year: 2022).*

(Continued)

Primary Examiner — Sanjeev Paul
(74) *Attorney, Agent, or Firm* — ScienBiziP, P.C.

(57) **CLAIM**

The ornamental design for a body pillow, as shown and described.

(56) **References Cited**

U.S. PATENT DOCUMENTS

D114,973 S * 5/1939 Eckman 5/636
D201,492 S * 6/1965 Jacobson D6/601
D216,525 S * 2/1970 Meinwieser D6/604
D218,888 S * 10/1970 Blank D6/601
D242,388 S * 11/1976 Castleberry 5/636
D242,390 S * 11/1976 Grube D6/601
4,956,886 A * 9/1990 Sarkozi A47G 9/10
5/636
5,528,784 A * 6/1996 Painter A47G 9/10
5/636
D382,435 S * 8/1997 Schaffner D6/601
D404,238 S * 1/1999 Keilhauer D6/601
5,987,674 A * 11/1999 Schaffner A47C 20/023
5/652

DESCRIPTION

FIG. 1 is a front, right, and top perspective view of a body pillow, showing my design.
FIG. 2 is a rear, left, and bottom perspective view thereof.
FIG. 3 is a front elevation view thereof.
FIG. 4 is a rear elevation view thereof.
FIG. 5 is a left side elevation view thereof.
FIG. 6 is a right side elevation view thereof.
FIG. 7 is a top plan view thereof; and,
FIG. 8 is a bottom plan view thereof.

1 Claim, 8 Drawing Sheets

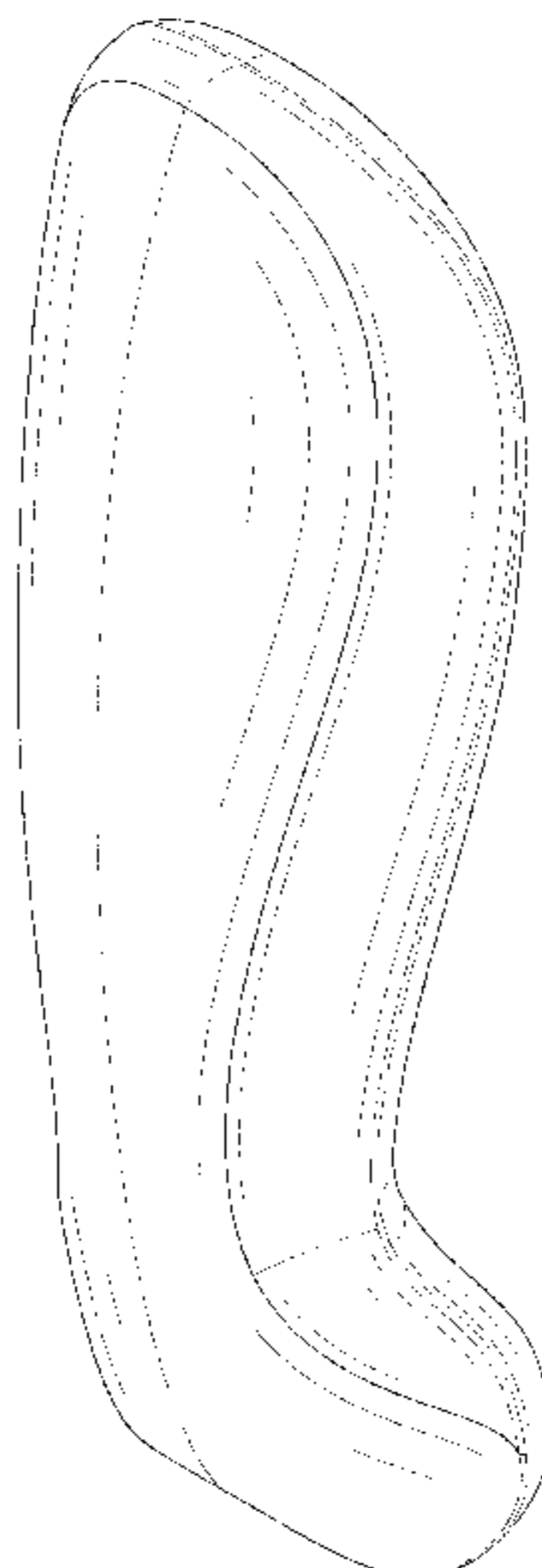

(56)

References Cited

U.S. PATENT DOCUMENTS

6,751,817 B1 * 6/2004 Leach A47D 13/083
5/652
6,874,183 B1 * 4/2005 Taylor A47C 20/027
5/652
7,114,206 B2 * 10/2006 Leach A47C 20/021
5/652
7,513,001 B1 * 4/2009 Leach A47G 9/1045
5/655
7,793,371 B1 * 9/2010 Leach A47C 20/025
5/655
D663,150 S * 7/2012 Oberpriller D6/601
D665,506 S * 8/2012 Derrick D24/191
D666,861 S * 9/2012 Phillips D6/601
9,021,635 B1 * 5/2015 Leach A47C 20/02
5/632
D736,011 S * 8/2015 Fresonke D6/601
D749,873 S * 2/2016 Latrofa D6/601
D768,409 S * 10/2016 Park D6/601
D769,649 S * 10/2016 Vargas D6/601
D804,850 S * 12/2017 Acosta De Nicolo D6/601
D828,702 S * 9/2018 Chen D6/601
D845,035 S * 4/2019 Raad D6/601
D850,817 S * 6/2019 Tong D6/601
D864,611 S * 10/2019 Gao D6/601
D871,796 S * 1/2020 Mi D6/601
10,736,444 B1 * 8/2020 Leach A47G 9/0253
D896,549 S * 9/2020 Rozon D6/601
D898,431 S * 10/2020 Huang D6/601

D906,013 S * 12/2020 Chunyu D6/601
D908,395 S * 1/2021 David D6/601
D914,398 S * 3/2021 Gao D6/601
D923,971 S * 7/2021 Qiu D6/601
D944,564 S * 3/2022 Qiu D6/601
D946,310 S * 3/2022 Xu D6/601
2005/0066443 A1 * 3/2005 Rivera-Wienhold
A47D 13/08
5/655
2005/0257320 A1 * 11/2005 Mollett A47G 9/10
5/636
2007/0283495 A1 * 12/2007 Ghani A47G 9/10
5/636
2008/0148487 A1 * 6/2008 Lord A47C 20/021
5/632
2011/0173754 A1 * 7/2011 Calder A47G 9/1027
5/644
2015/0173524 A1 * 6/2015 McQuilton A47D 15/00
5/652
2018/0049550 A1 * 2/2018 Levy A47G 9/1027

OTHER PUBLICATIONS

Google Term Search: 'Pregnancy Pillow', [site visited Aug. 26, 2022] <URL: https://www.google.com/search?q=pregnancy+pillow&sxsrf=ALiCzsZsj9rowsXdp1VT-wXwXrfAqwWg8A:1661647034815&source=lnms&tbm=isch&sa=X&ved=2ahUKEwif7IHKpej5AhWJGIkFHYKLCFcQ_AUoAnoECAEQBA&biw=1920&bih=880&dpr=1> (Year: 2022).*

* cited by examiner

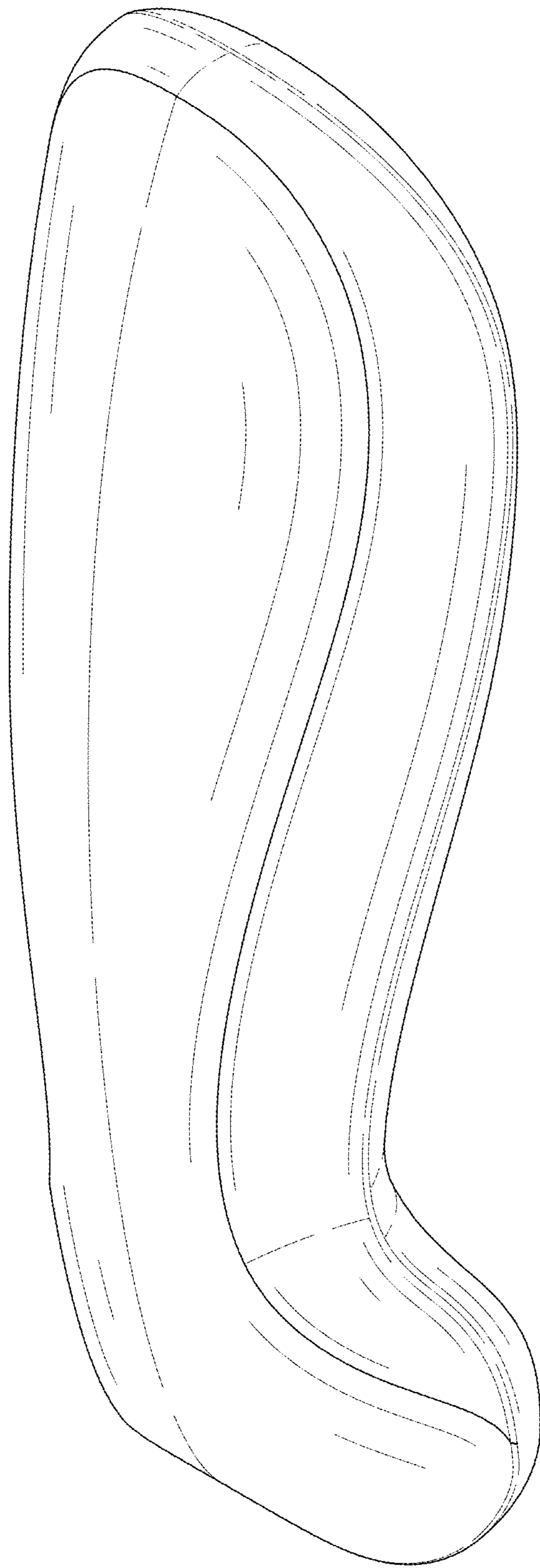

FIG. 1

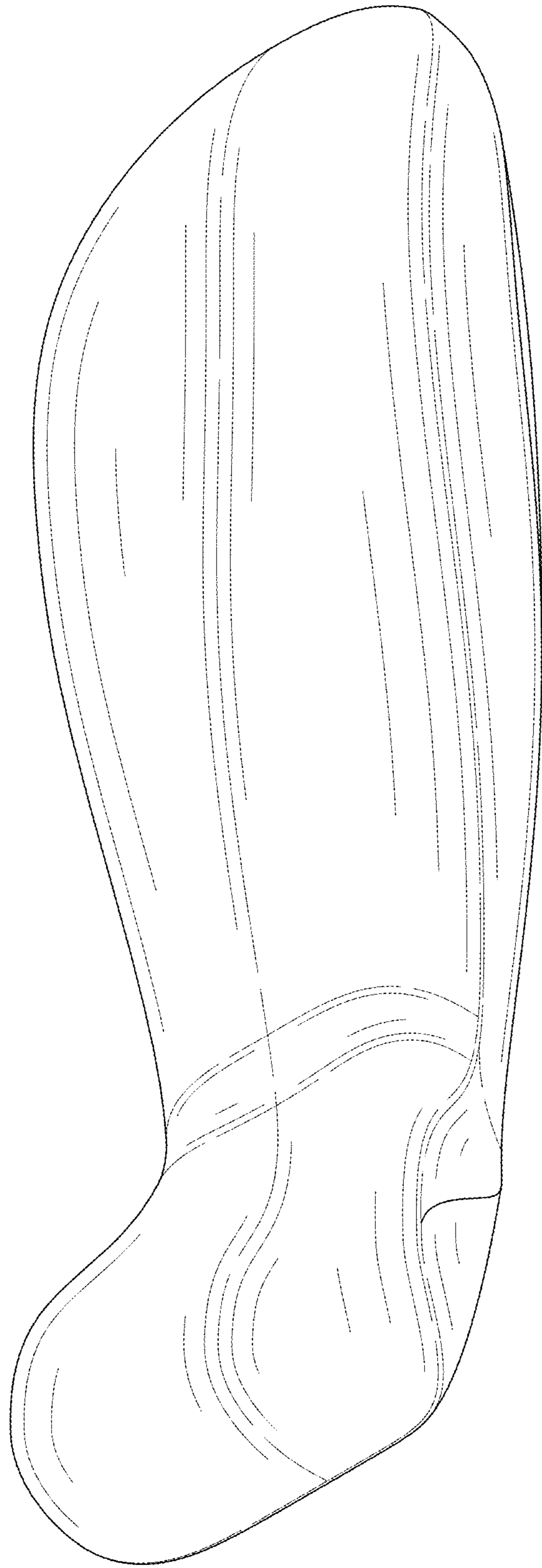

FIG. 2

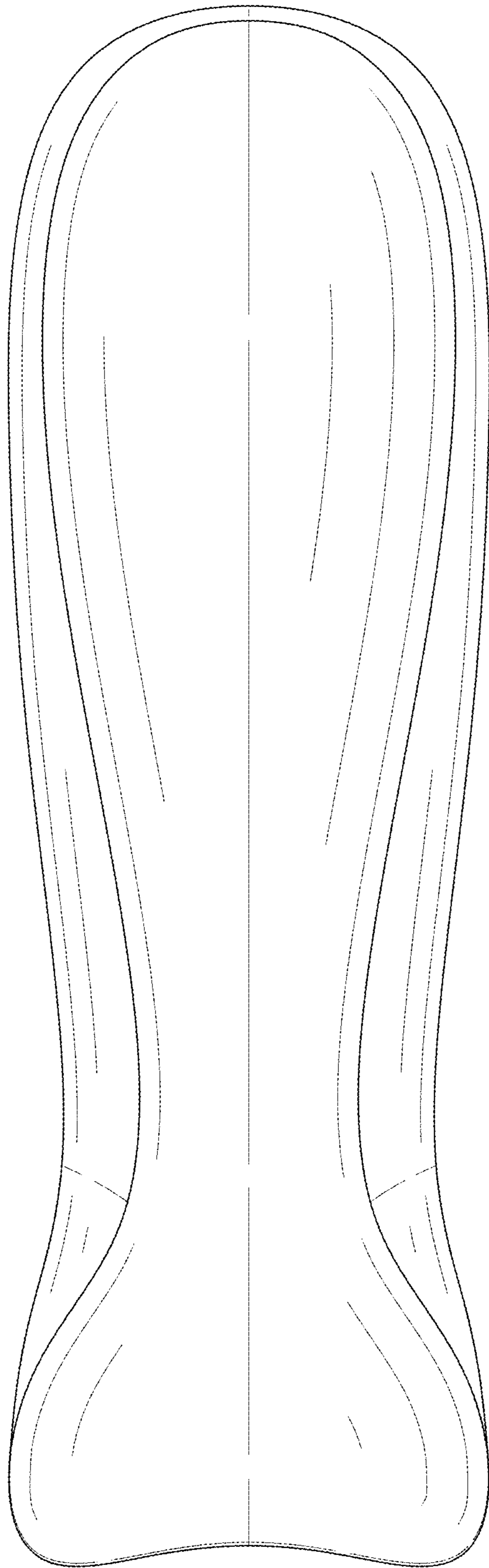

FIG. 3

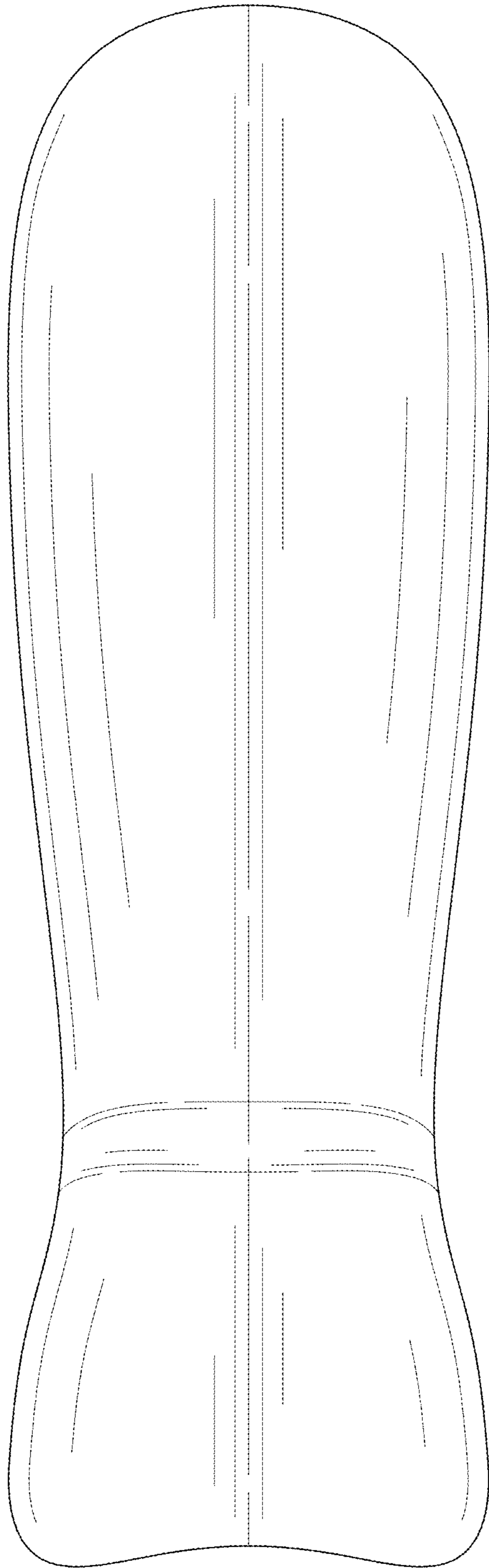

FIG. 4



FIG. 5

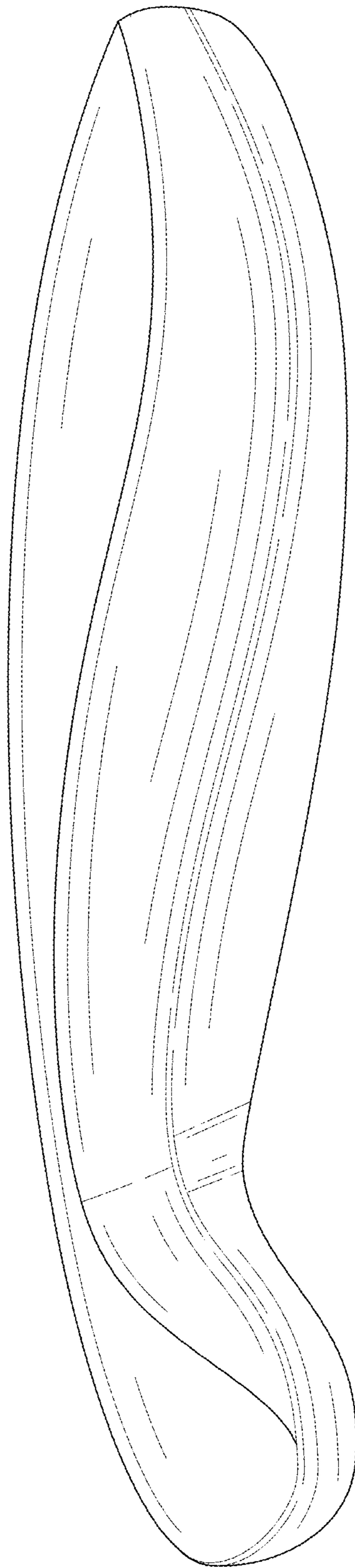

FIG. 6

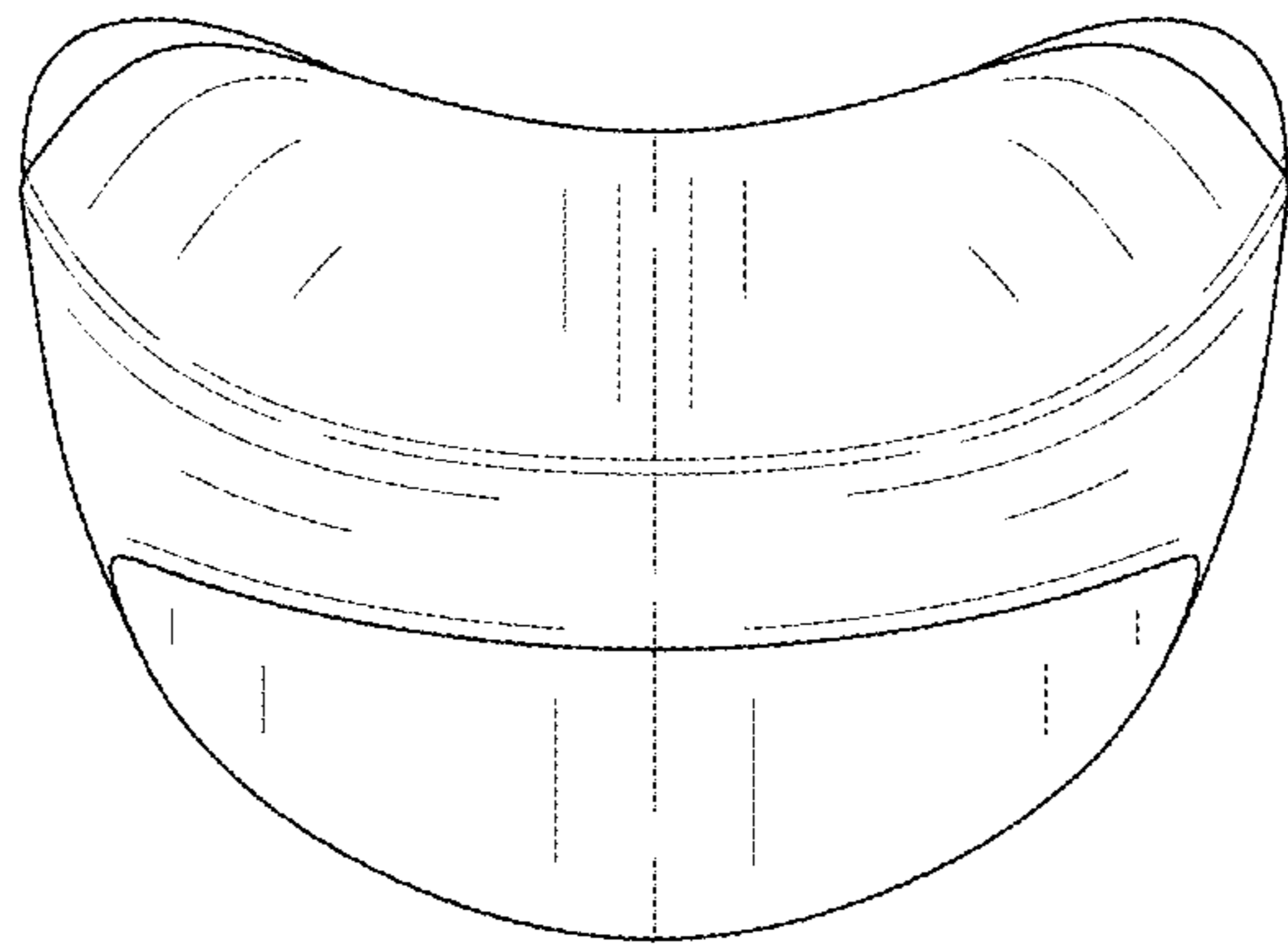

FIG. 7

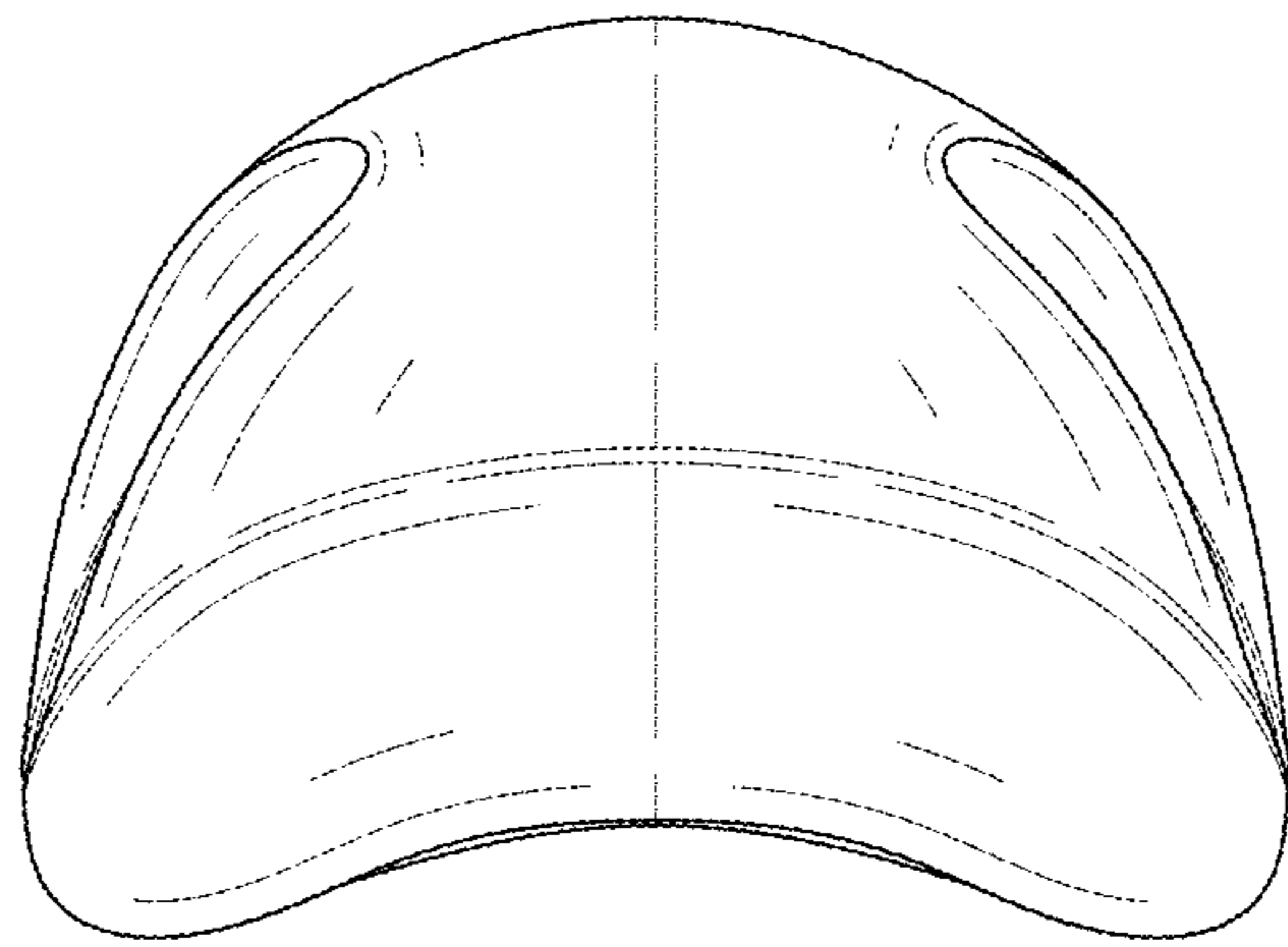

FIG. 8