

US00D966729S

(12) **United States Design Patent**
Esteve Cambra

(10) **Patent No.:** **US D966,729 S**

(45) **Date of Patent:** **** Oct. 18, 2022**

(54) **SOFA**

(71) Applicant: **RH US, LLC**, Corte Madera, CA (US)

(72) Inventor: **Jose Ramón Esteve Cambra**, Valencia (ES)

(73) Assignee: **RH US, LLC**, Corte Madera, CA (US)

(**) Term: **15 Years**

(21) Appl. No.: **29/766,553**

(22) Filed: **Jan. 15, 2021**

(51) **LOC (13) Cl.** **06-01**

(52) **U.S. Cl.**
USPC **D6/369**

(58) **Field of Classification Search**

USPC D6/334–347, 367, 369, 370, 371,
D6/373–375, 377, 378, 379, 381, 382,
D6/716, 717

CPC A47C 7/18; A47C 7/22; A47C 7/24; A47C
7/54; A47C 7/541; A47C 7/543; A47C
7/546; A47C 17/02; A47C 17/04; A47C
15/002; A47C 5/043

See application file for complete search history.

(56) **References Cited**

U.S. PATENT DOCUMENTS

D227,834 S * 7/1973 Oliver D6/379
D285,753 S * 9/1986 Zola D6/373
(Continued)

OTHER PUBLICATIONS

Malta Teak Sofa, available in rhmodern,rh.com, site visited Aug. 9, 2022, URL:<https://rhmodern.rh.com/catalog/product/product.jsp?productId=prod19920166&sale=false> (Year: 2022).*

Primary Examiner — Joseph Kukella
Assistant Examiner — Mark David Wolfley

(74) *Attorney, Agent, or Firm* — Lewis Roca Rothgerber Christie LLP

(57) **CLAIM**

The ornamental design for a sofa, as shown and described.

DESCRIPTION

FIG. 1 is a front right perspective view of a first embodiment of a sofa showing my new design;

FIG. 2 is a rear left perspective view thereof;

FIG. 3 is a front elevation view thereof;

FIG. 4 is a right side elevation view thereof, the left side view being a mirror image;

FIG. 5 is a rear elevation view thereof;

FIG. 6 is a top plan view thereof;

FIG. 7 is an enlarged detail view taken from the area labelled 7 in FIG. 2;

FIG. 8 is an enlarged detail view taken from the area labelled 8 in FIG. 5;

FIG. 9 is a front right perspective view of a second embodiment of a sofa showing my new design;

FIG. 10 is a rear left perspective view thereof;

FIG. 11 is a front elevation view thereof;

FIG. 12 is a right side elevation view thereof, the left side view being a mirror image;

FIG. 13 is a rear elevation view thereof;

FIG. 14 is a top plan view thereof;

FIG. 15 is an enlarged detail view taken from the area labelled 15 in FIG. 10; and,

FIG. 16 is an enlarged detail view taken from the area labelled 16 in FIG. 13.

The fragmentary showing of a weave pattern in FIGS. 2, 4, 5, 10, 12, and 13, and shown in detail in FIGS. 7, 8, 15, and 16, is understood to be repeated throughout the surfaces shown. The broken lines show environmental subject matter and form no part of the claimed design. The second embodiment is shown with symbolic breaks in FIGS. 9, 10, 11, 13, and 14, and those portions of the article between the break lines form no part of the claimed design.

1 Claim, 14 Drawing Sheets

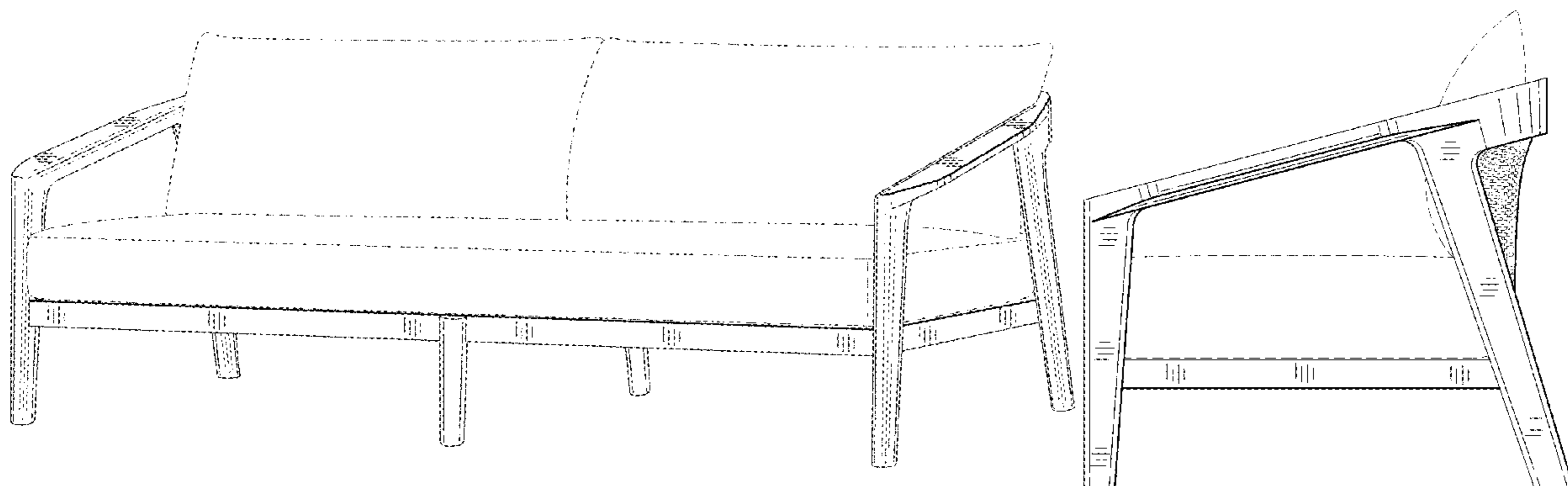

(56)

References Cited

U.S. PATENT DOCUMENTS

D297,791	S	*	9/1988	Kopp	D6/381
D524,565	S	*	7/2006	Franks	D6/369
D545,070	S	*	6/2007	Hutton	D6/334
D640,479	S	*	6/2011	Sempe	D6/375
D660,036	S	*	5/2012	Grotta	D6/370
D824,186	S	*	7/2018	Barber	D6/379
D852,533	S	*	7/2019	Asner	D6/379
D867,008	S	*	11/2019	Lievore	D6/381
D897,128	S	*	9/2020	Killinger	D6/381
D909,086	S	*	2/2021	Maynes	D6/379
D927,876	S	*	8/2021	Vering	D6/369
D927,877	S	*	8/2021	Vering	D6/369
2019/0090646	A1	*	3/2019	Adams	A47C 1/14

* cited by examiner

FIG. 1

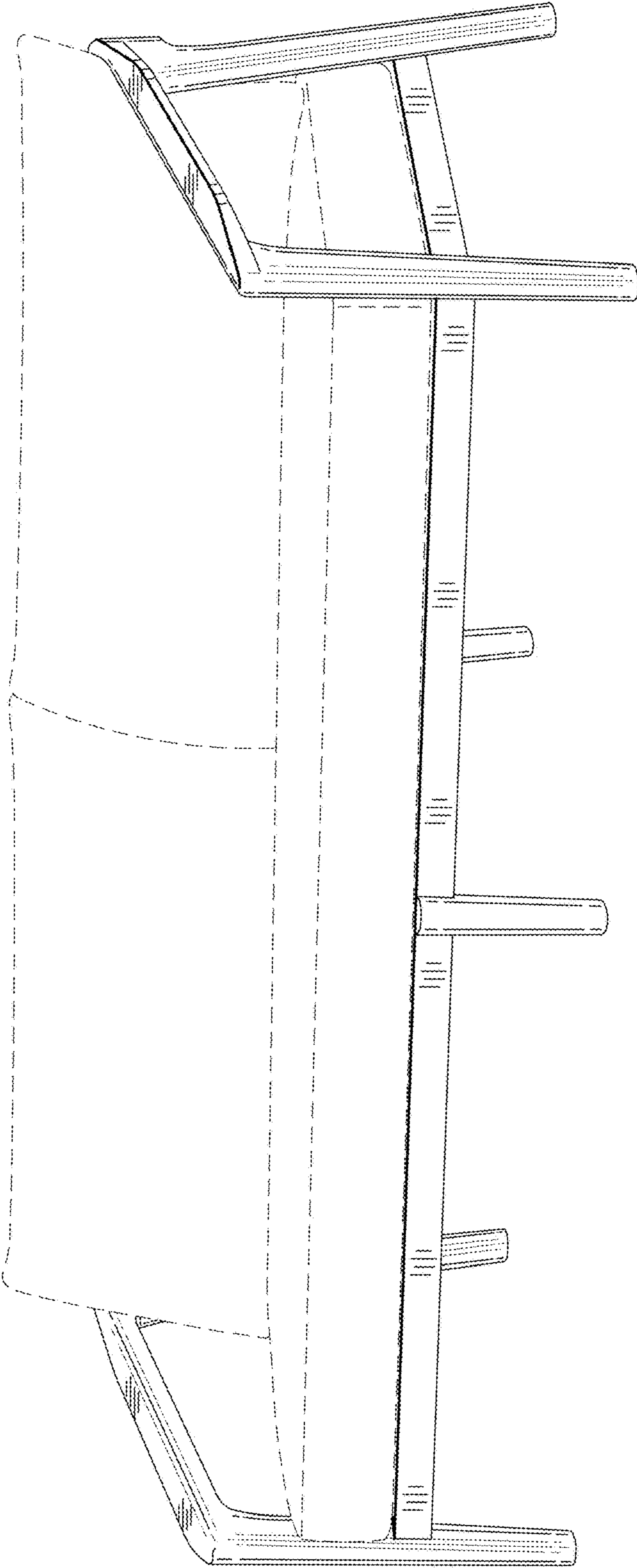

FIG. 2

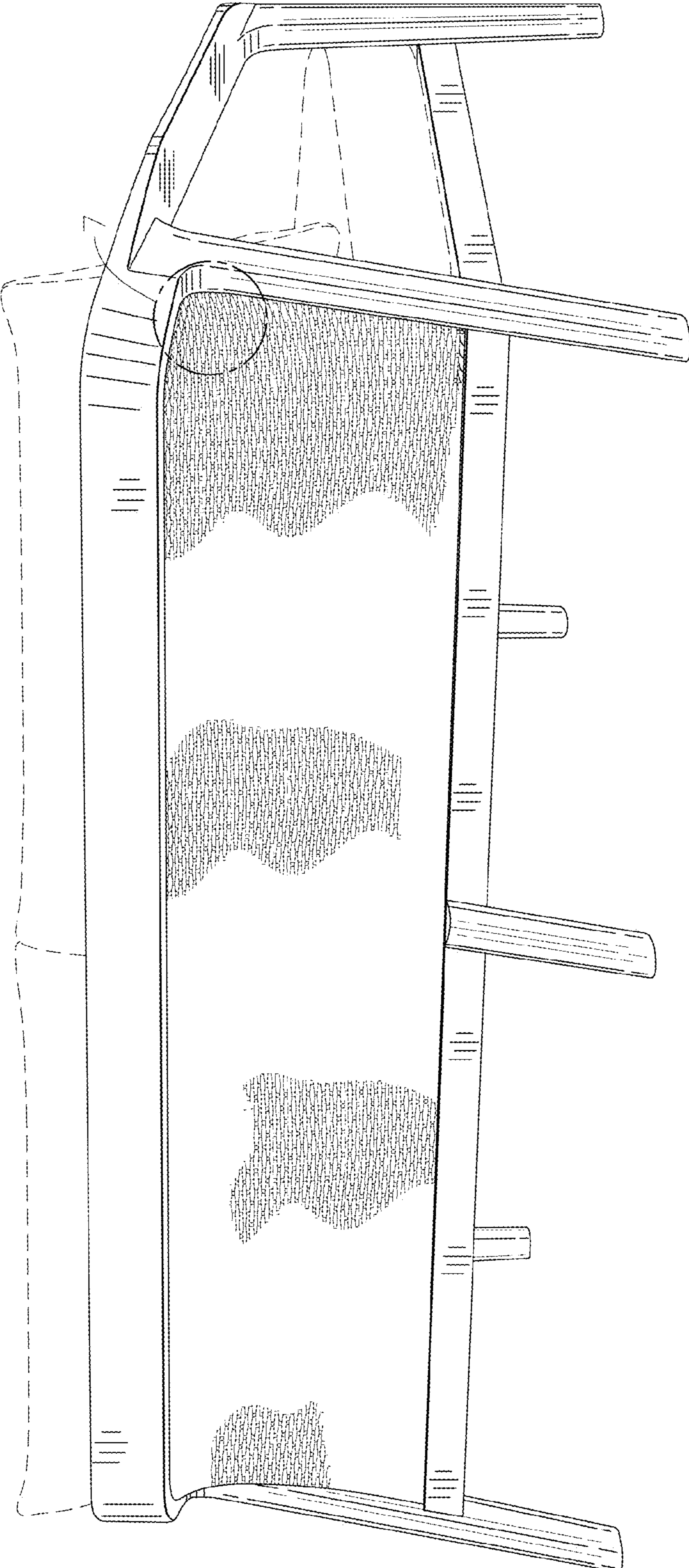

FIG. 3

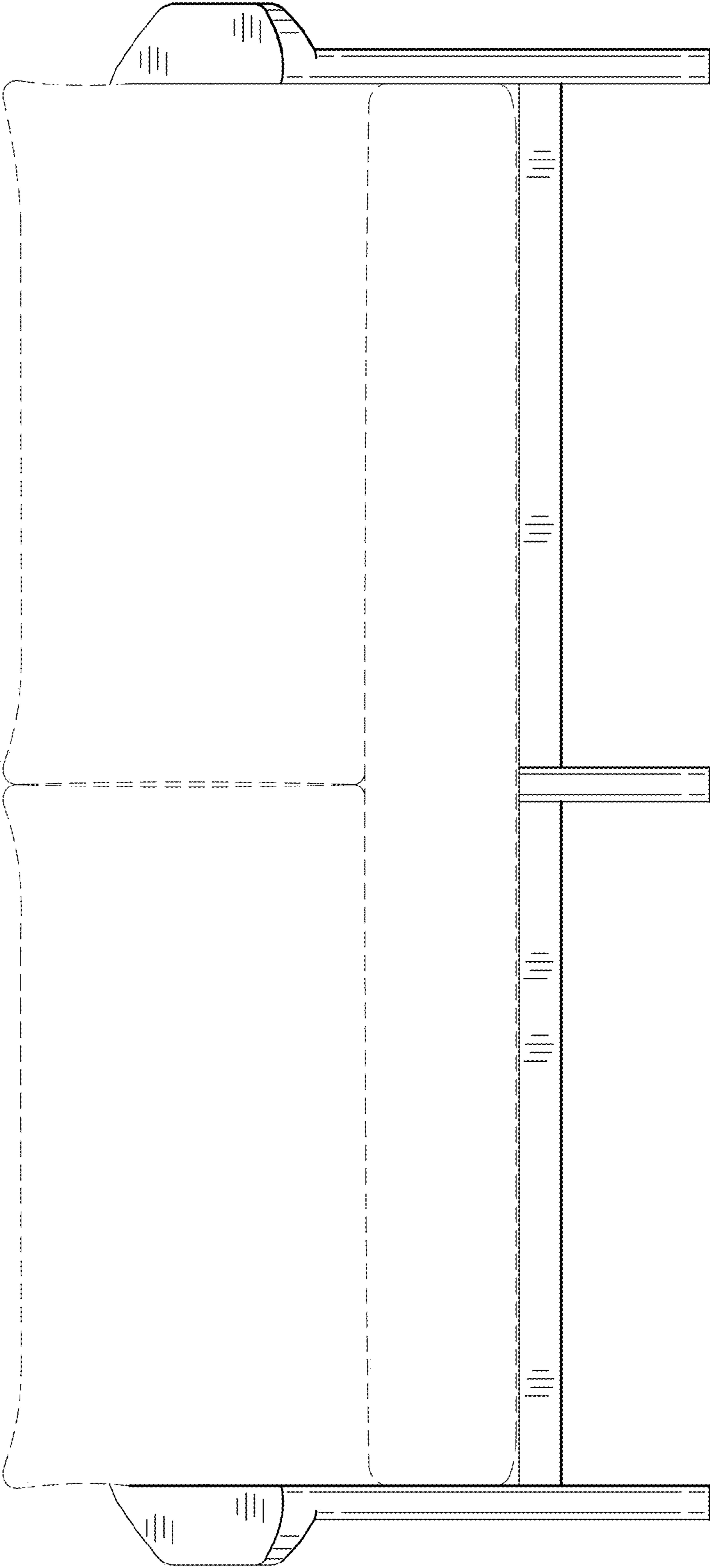

FIG. 4

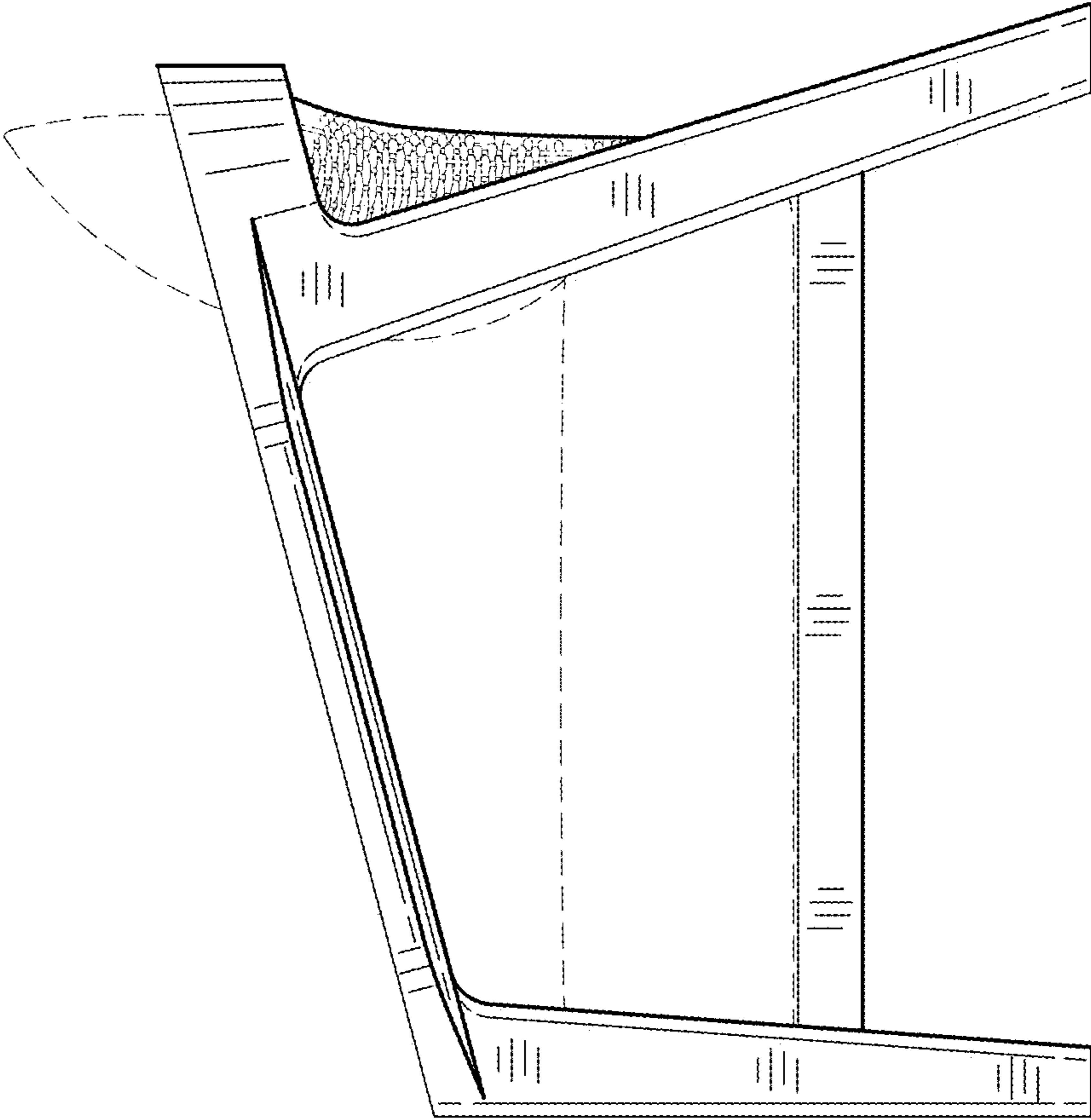

FIG. 5

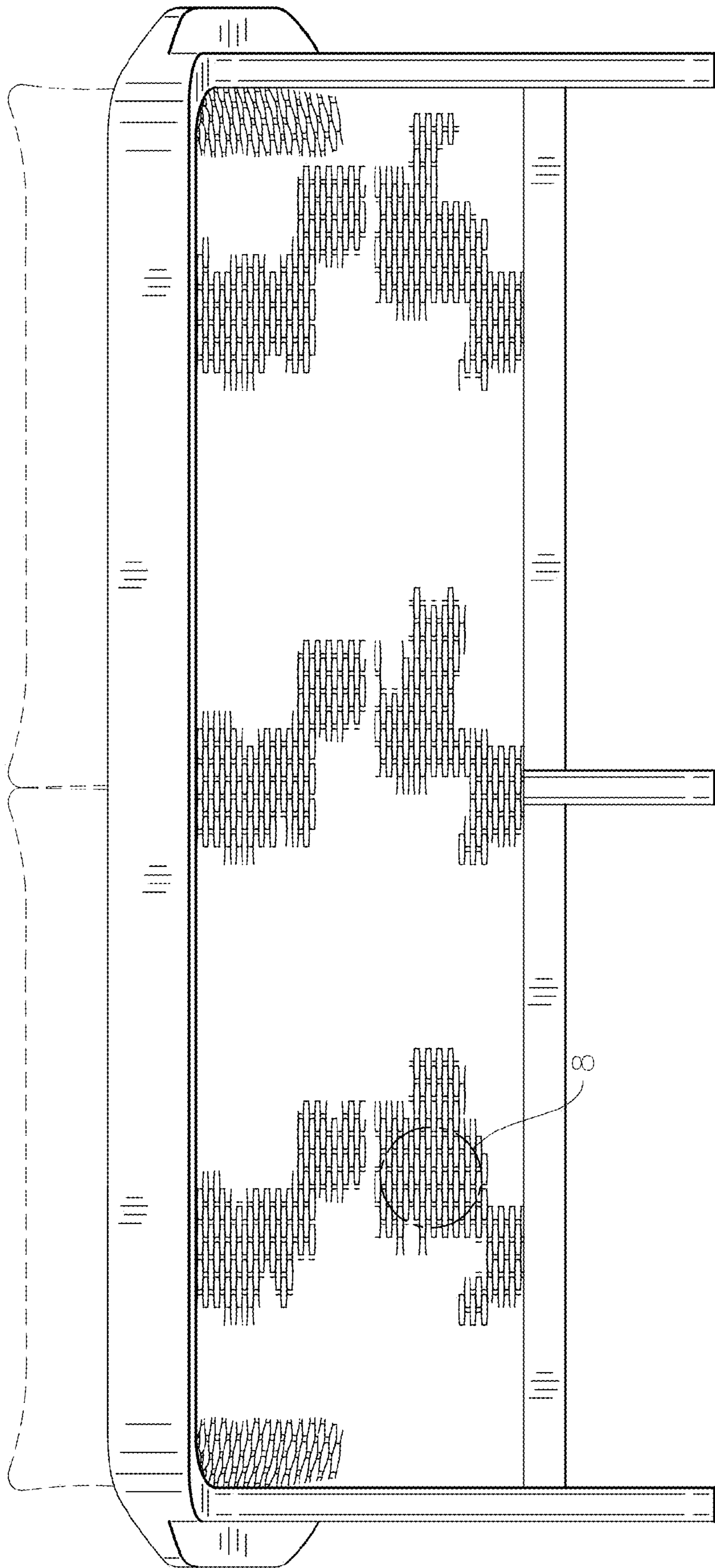

FIG. 6

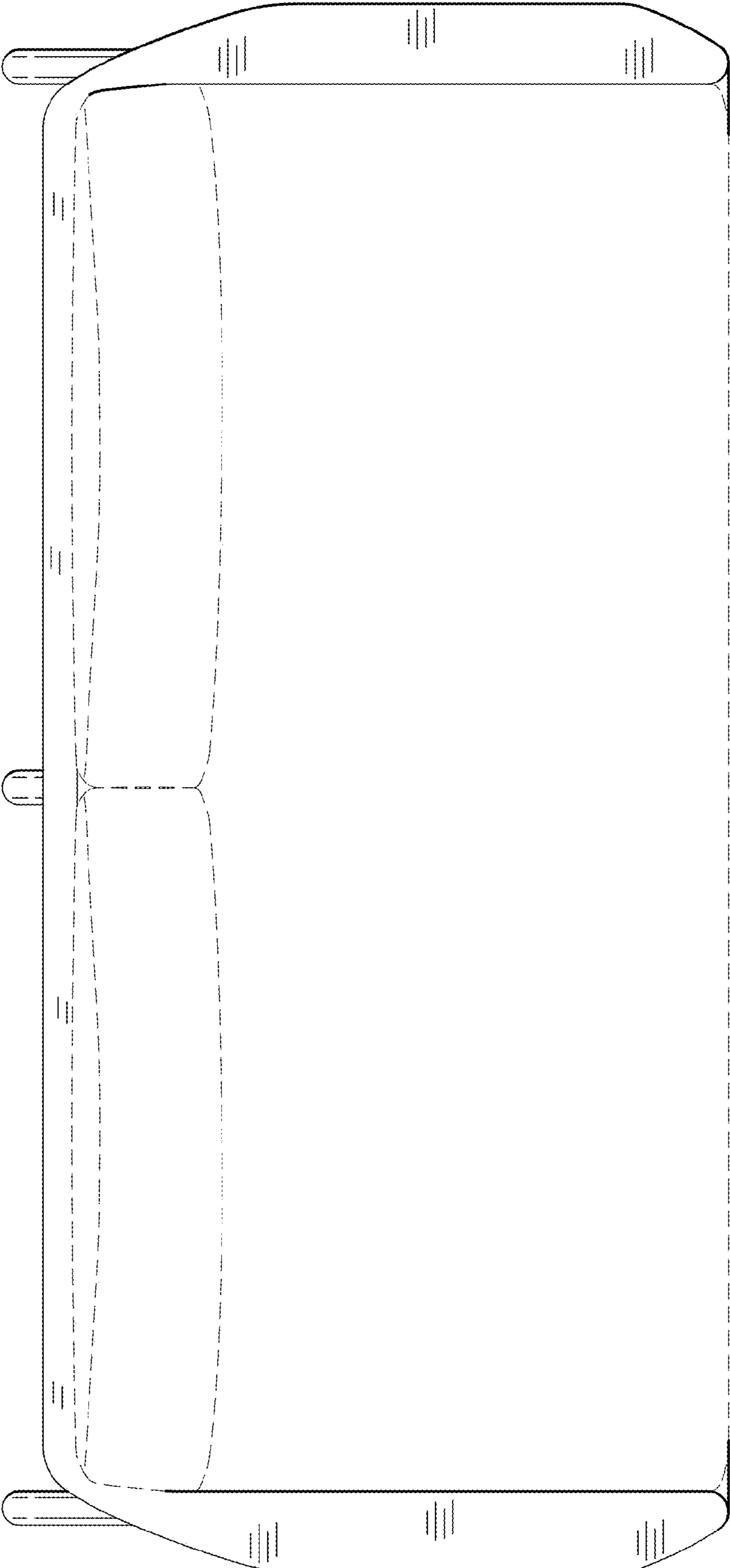

FIG. 8

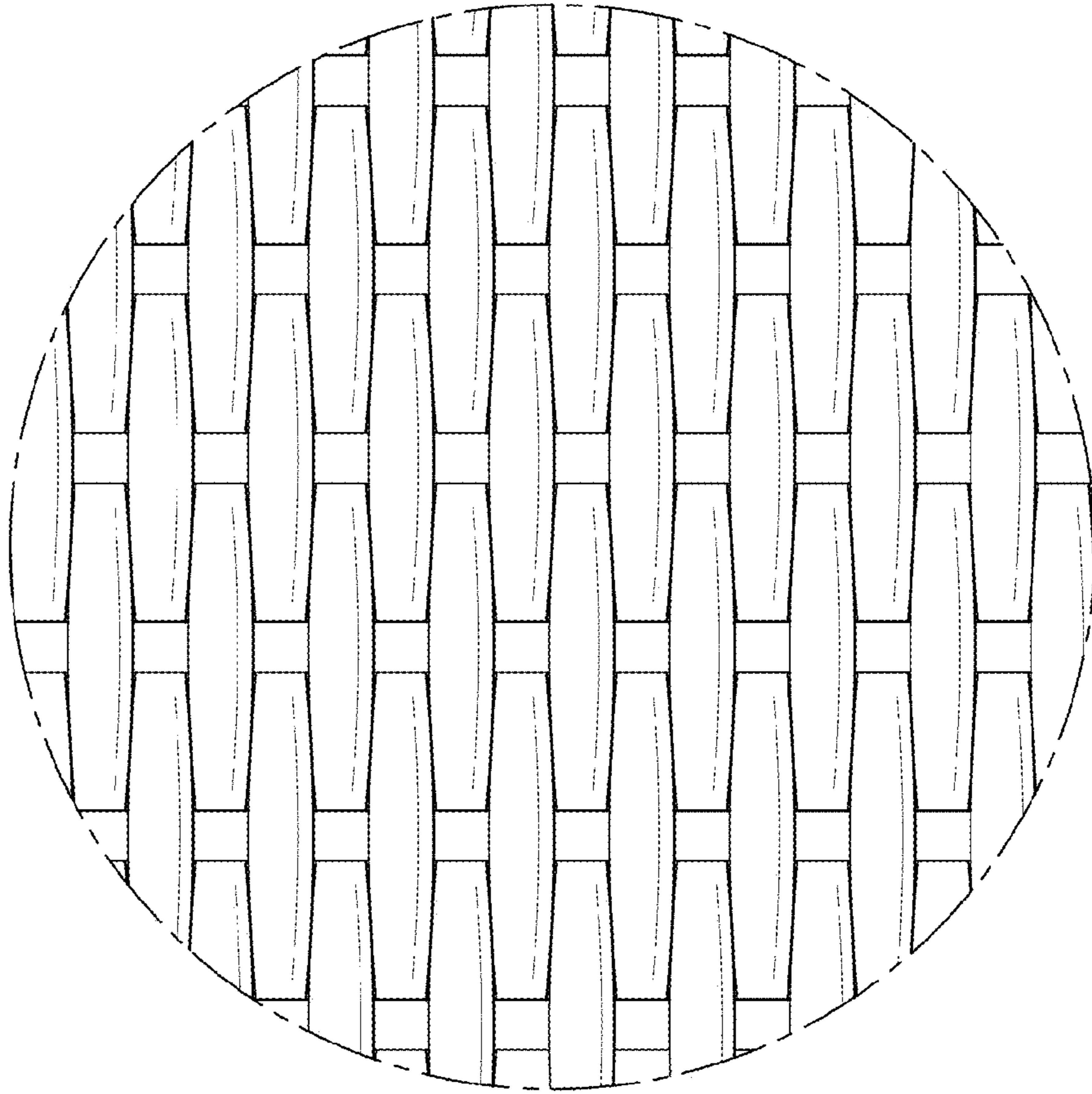

FIG. 7

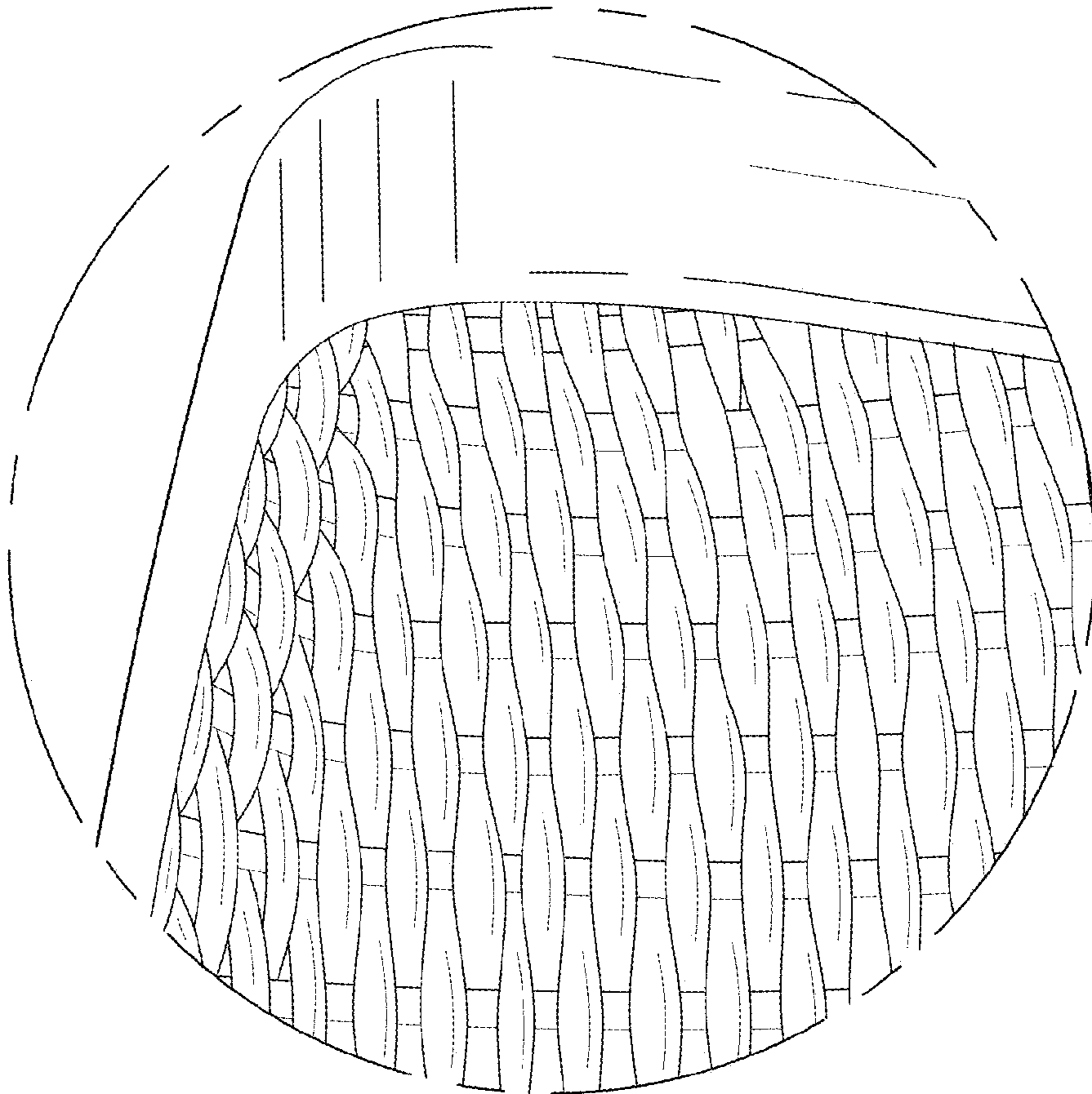

FIG. 9

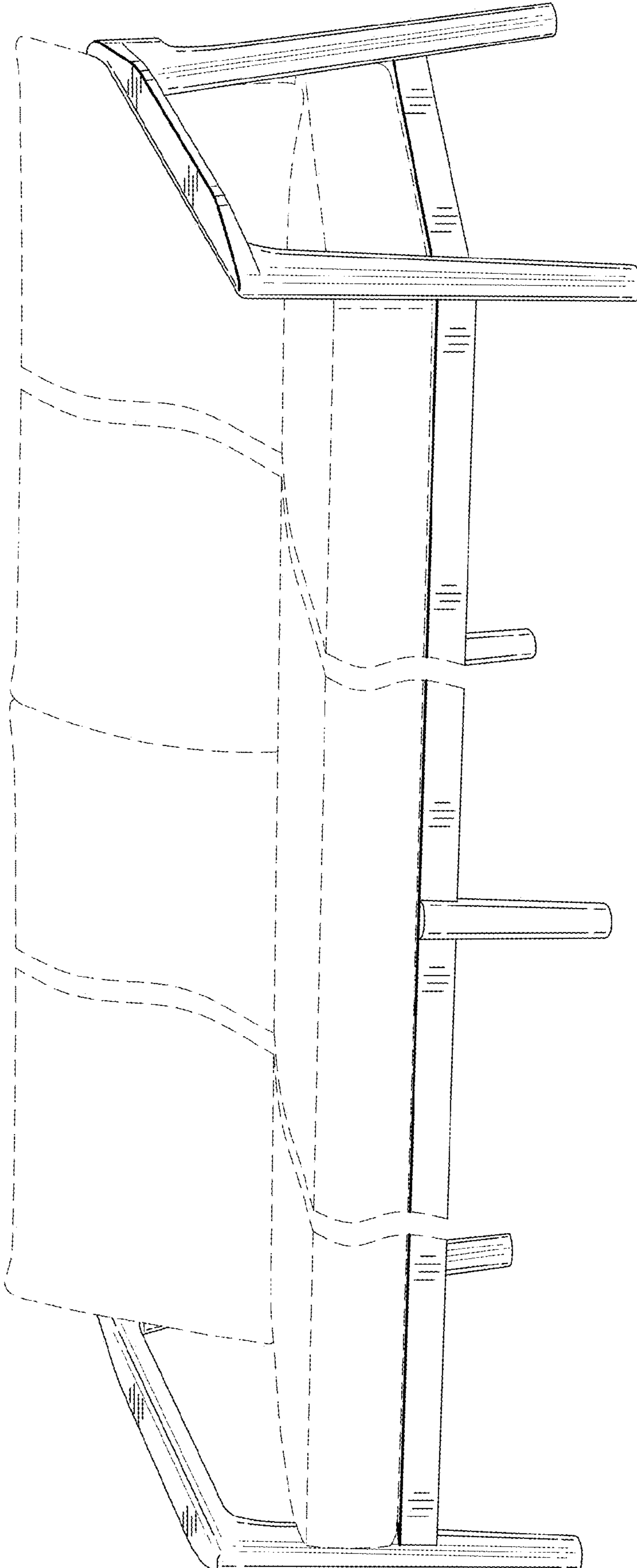

FIG. 10

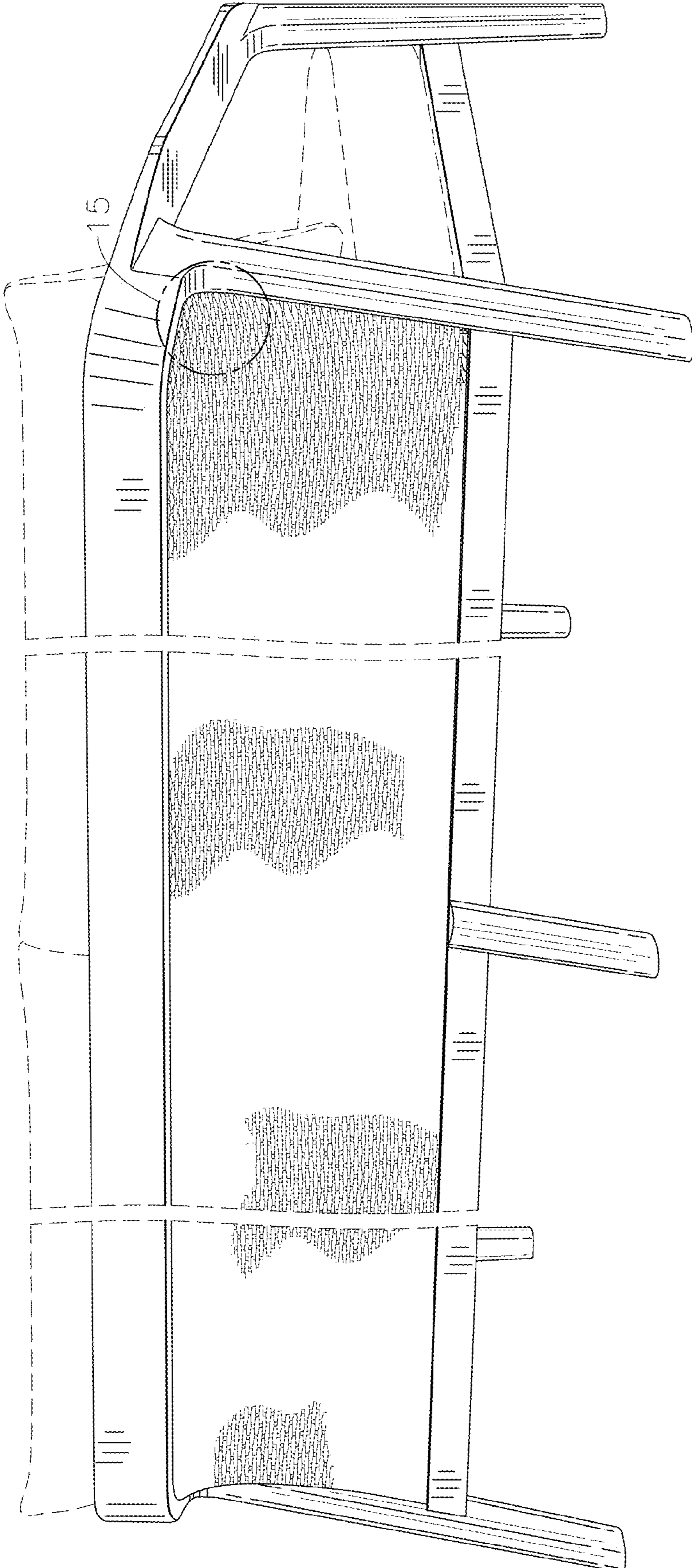

FIG. 11

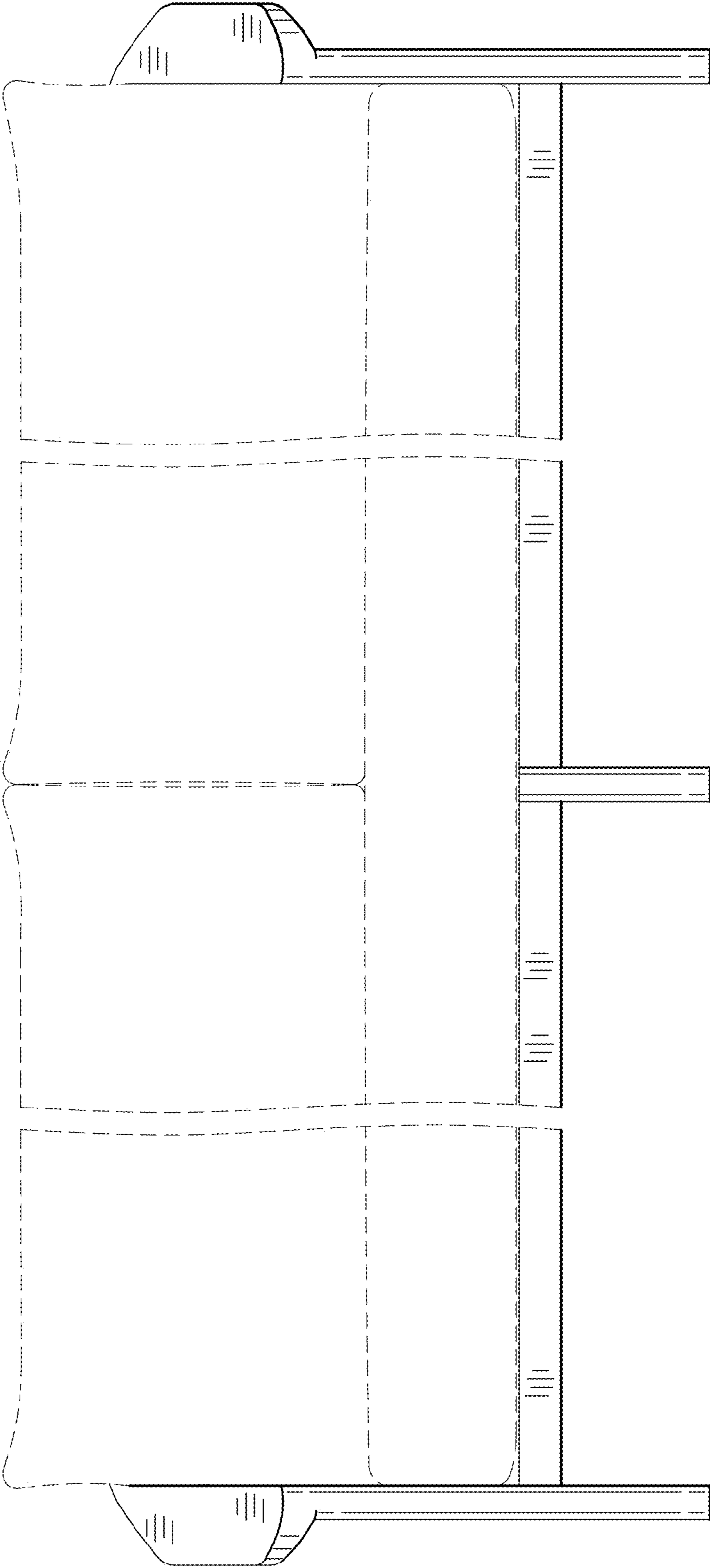

FIG. 12

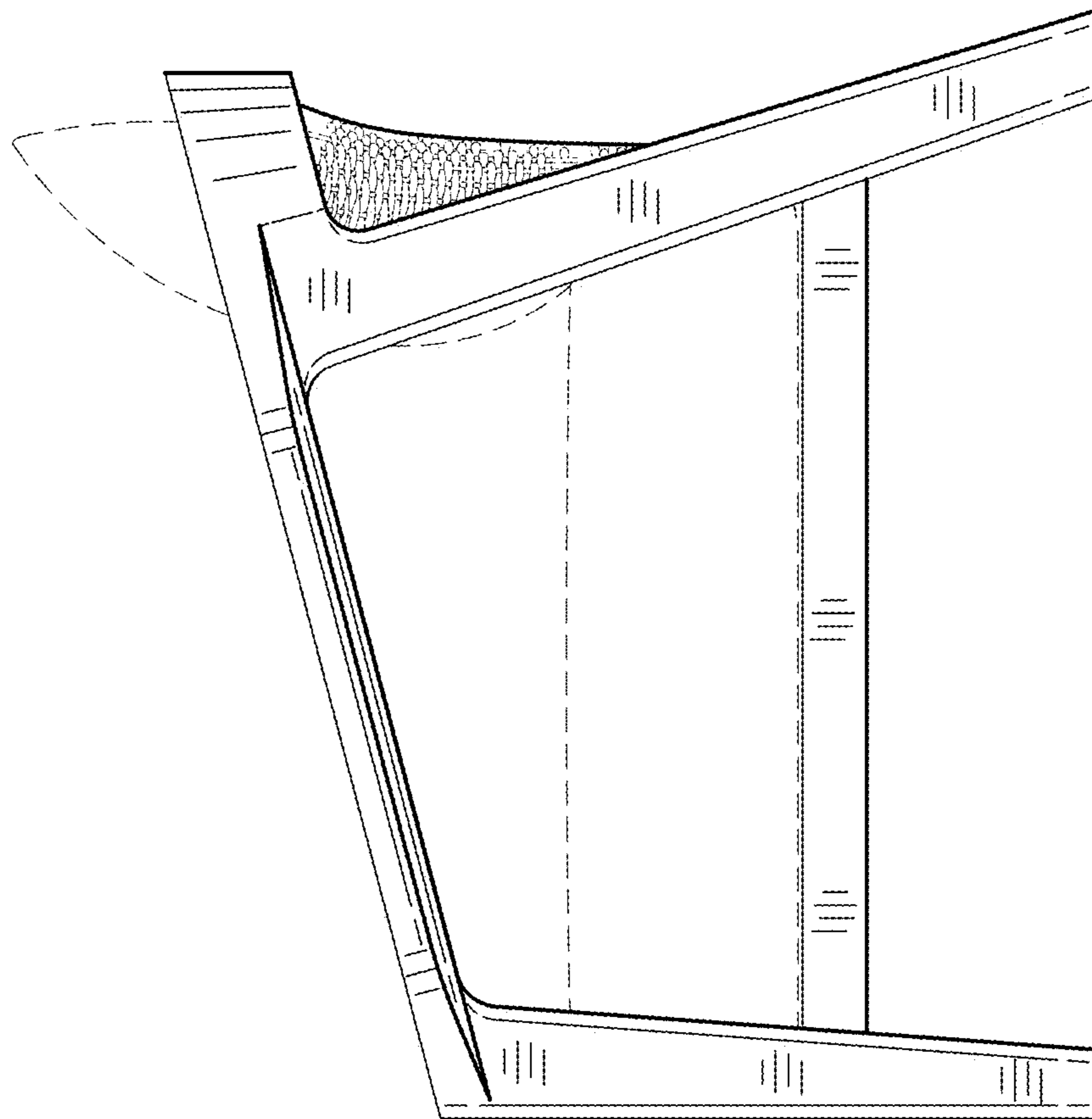

FIG. 13

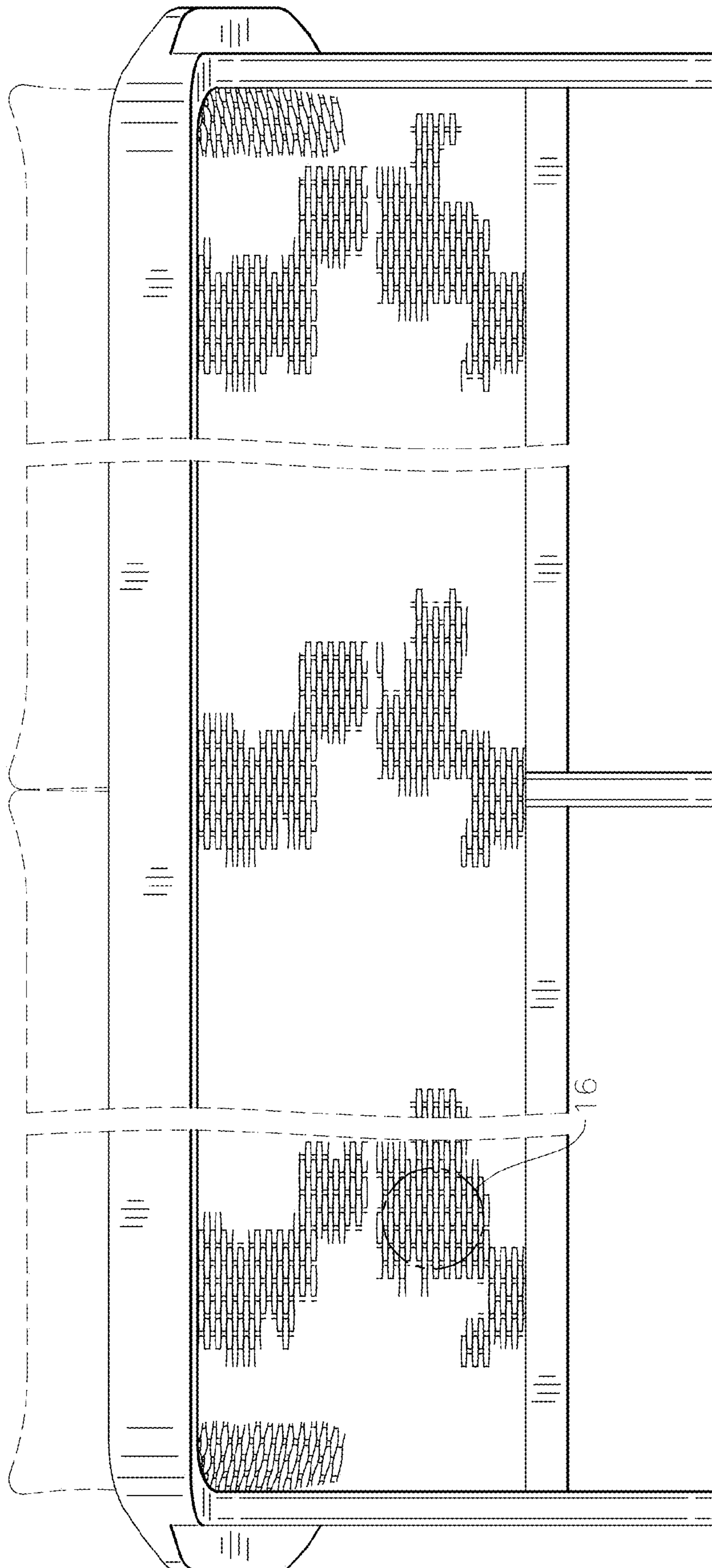

FIG. 14

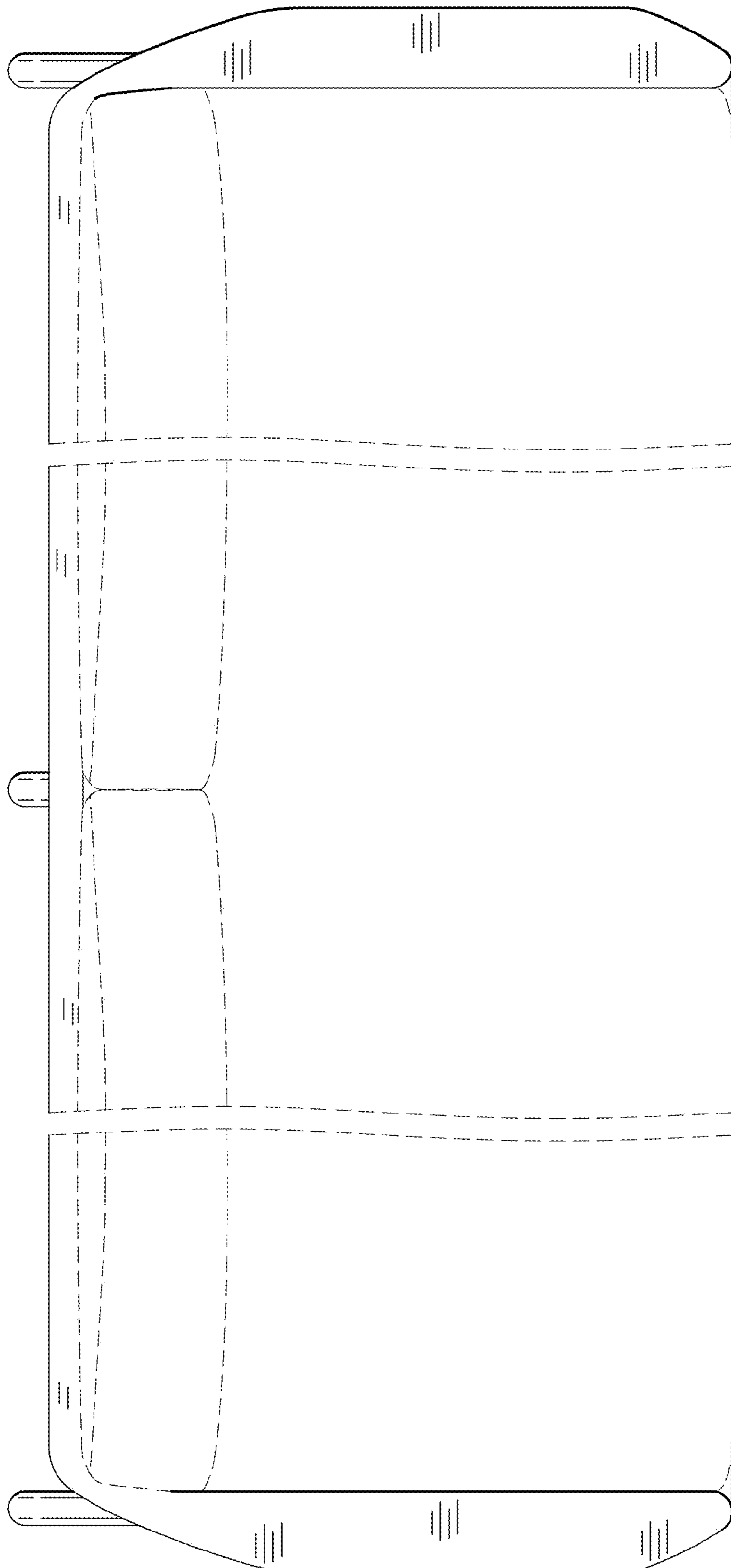

FIG. 16

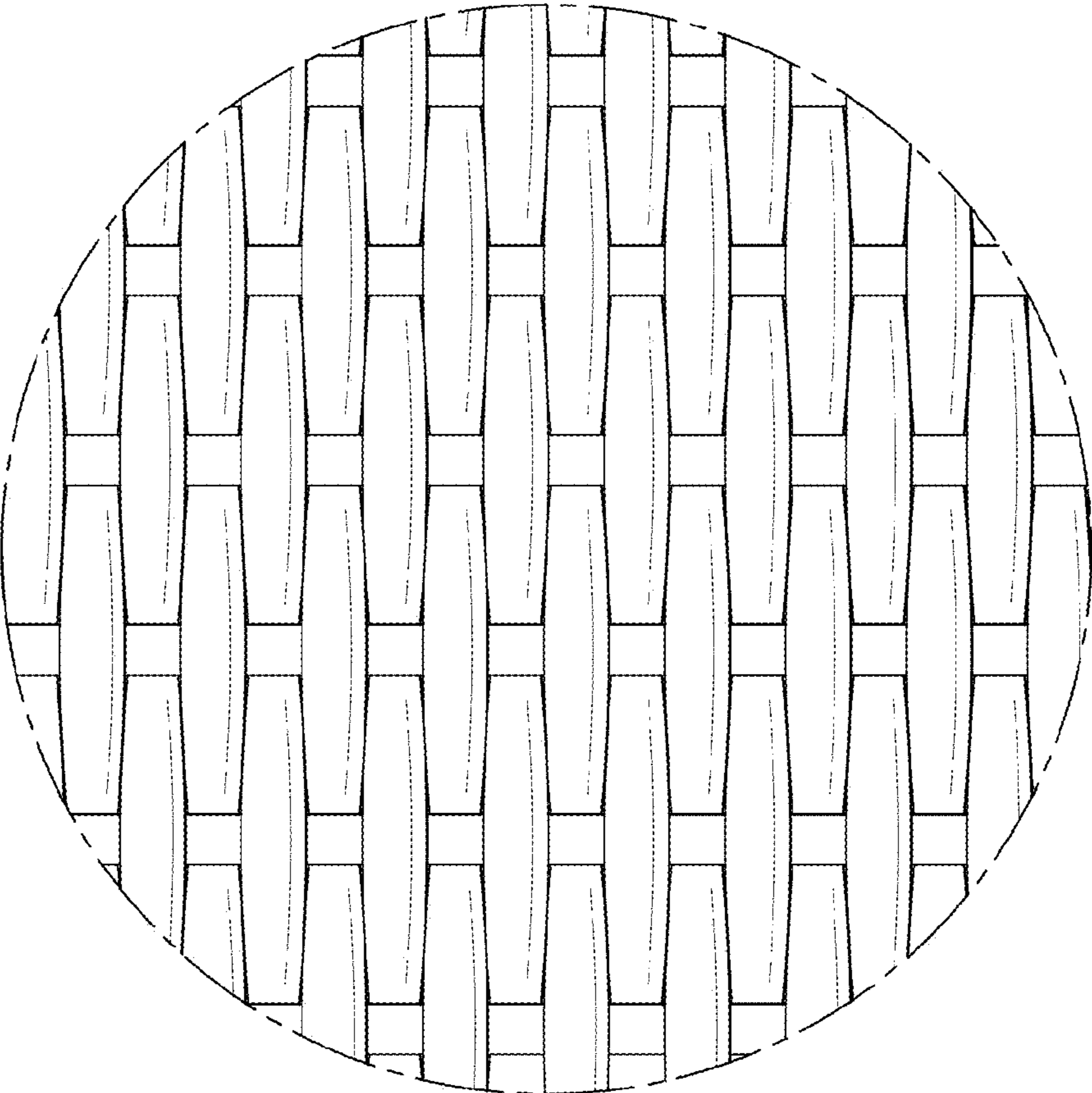

FIG. 15

