



US00D966713S

(12) **United States Design Patent** (10) **Patent No.:** **US D966,713 S**
Cardenas (45) **Date of Patent:** **** *Oct. 18, 2022**

(54) **HANDBAG CLASP**

- (71) Applicant: **J. Choo Limited**, London (GB)
- (72) Inventor: **Johanna Cardenas**, Paris (FR)
- (73) Assignee: **J. Choo Limited**, London (GB)
- (*) Notice: This patent is subject to a terminal disclaimer.
- (**) Term: **15 Years**

(21) Appl. No.: **29/738,296**

(22) Filed: **Jun. 16, 2020**

(30) **Foreign Application Priority Data**

Jun. 3, 2020 (EM) 007983366-0003

(51) **LOC (13) Cl.** **03-01**

(52) **U.S. Cl.**
USPC **D3/325; D11/5; D11/34; D11/238; D3/318**

(58) **Field of Classification Search**

USPC D3/18-20, 231-233, 239-246, 318-325, D3/327, 247-252; D2/627-640, 946, D2/971, 976, 916, 925, 934; D11/1-18, D11/31, 81, 200, 201, 204, 211, 216, 219, D11/231, 234, 26, 30, 62, 237, 34, 78
CPC A45C 1/024; A45C 3/06; A45C 3/08
See application file for complete search history.

(56) **References Cited**

U.S. PATENT DOCUMENTS

D45,102 S	1/1914	Byers	
D436,550 S *	1/2001	Versace	D11/26
D454,514 S *	3/2002	Gruosi	D11/34
D454,515 S *	3/2002	Gruosi	D11/34
D454,809 S *	3/2002	Gruosi	D11/26
D571,557 S *	6/2008	Lawler	D3/318
D591,490 S	5/2009	Lawler	

(Continued)

FOREIGN PATENT DOCUMENTS

CN	303814929	*	8/2016
FR	990347-003	*	5/1999

OTHER PUBLICATIONS

Youtube.com, Site visited Mar. 24, 2022, "Huge Antique Victorian Diamond Snake Brooch," published on Apr. 29, 2015 by Victoria Sterling Jewelry features an antique Victorian Diamond Snake Brooch, <https://youtu.be/VjrX5dHVzHQ> (Year: 2015).*

(Continued)

Primary Examiner — Brett Miller

Assistant Examiner — Jessica M Gebhart

(74) *Attorney, Agent, or Firm* — Fross Zelnick Lehrman & Zissu, P.C.; Lawrence E. Apolzon, Esq.

(57) **CLAIM**

The ornamental design for a handbag clasp, as shown and described.

DESCRIPTION

The patent or application file contains at least one drawing executed in color. Copies of this patent or patent application publication with color drawing(s) will be provided by the Office upon request and payment of the necessary fee.

FIG. 1 is a front perspective view of a handbag clasp showing my new design;

FIG. 2 is a front view thereof;

FIG. 3 is a back view thereof;

FIG. 4 is a left side view thereof;

FIG. 5 is right side view thereof;

FIG. 6 is a top view thereof; and,

FIG. 7 is a bottom view thereof.

The broken line showing of portions in the drawings are for illustrative purposes only and depicts unclaimed subject matter.

1 Claim, 7 Drawing Sheets
(6 of 7 Drawing Sheet(s) Filed in Color)

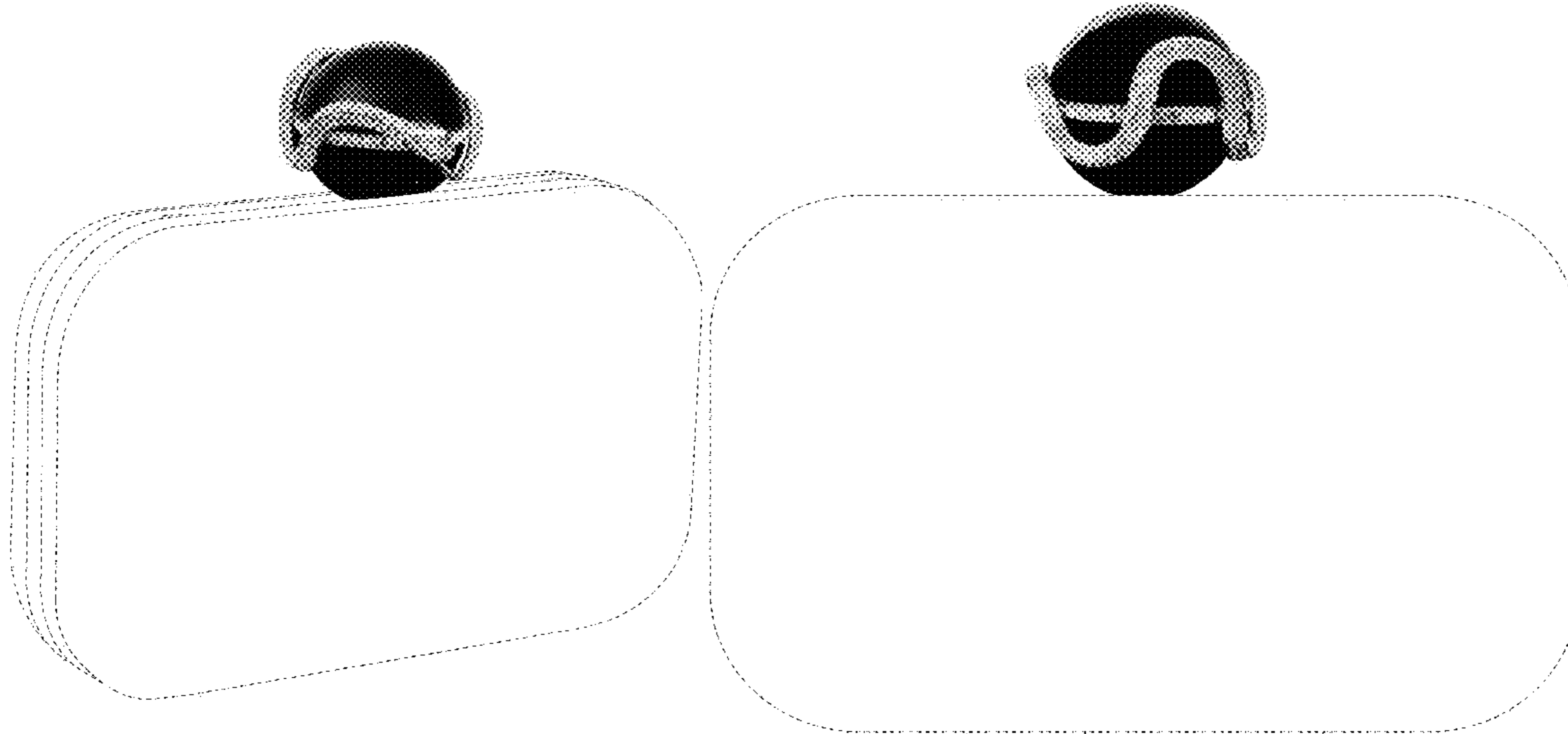

(56)

References Cited

U.S. PATENT DOCUMENTS

D627,251 S * 11/2010 Papadimitriou D11/34
D789,230 S * 6/2017 Zander D11/5

OTHER PUBLICATIONS

Amazon.com, Site visited Mar. 24, 2022, YYBONNIE Vintage Green Crystal Eye Cobra Snake Brooch, First available Mar. 5, 2019, <https://www.amazon.com/YYBONNIE-Vintage-Crystal-Animal-Cardigan/dp/B08TZT5NQX> (Year: 2019).*

* cited by examiner



FIG. 1

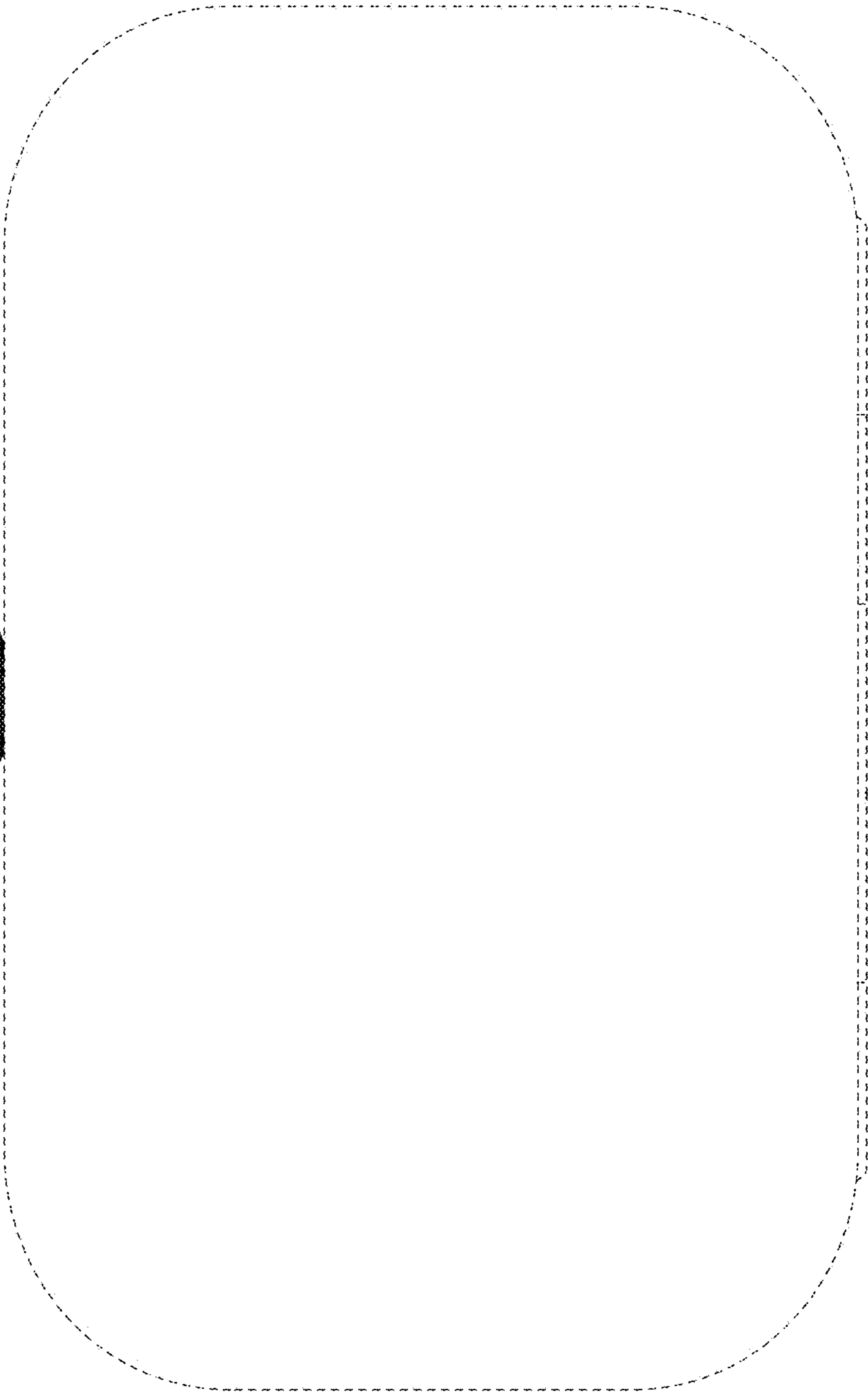
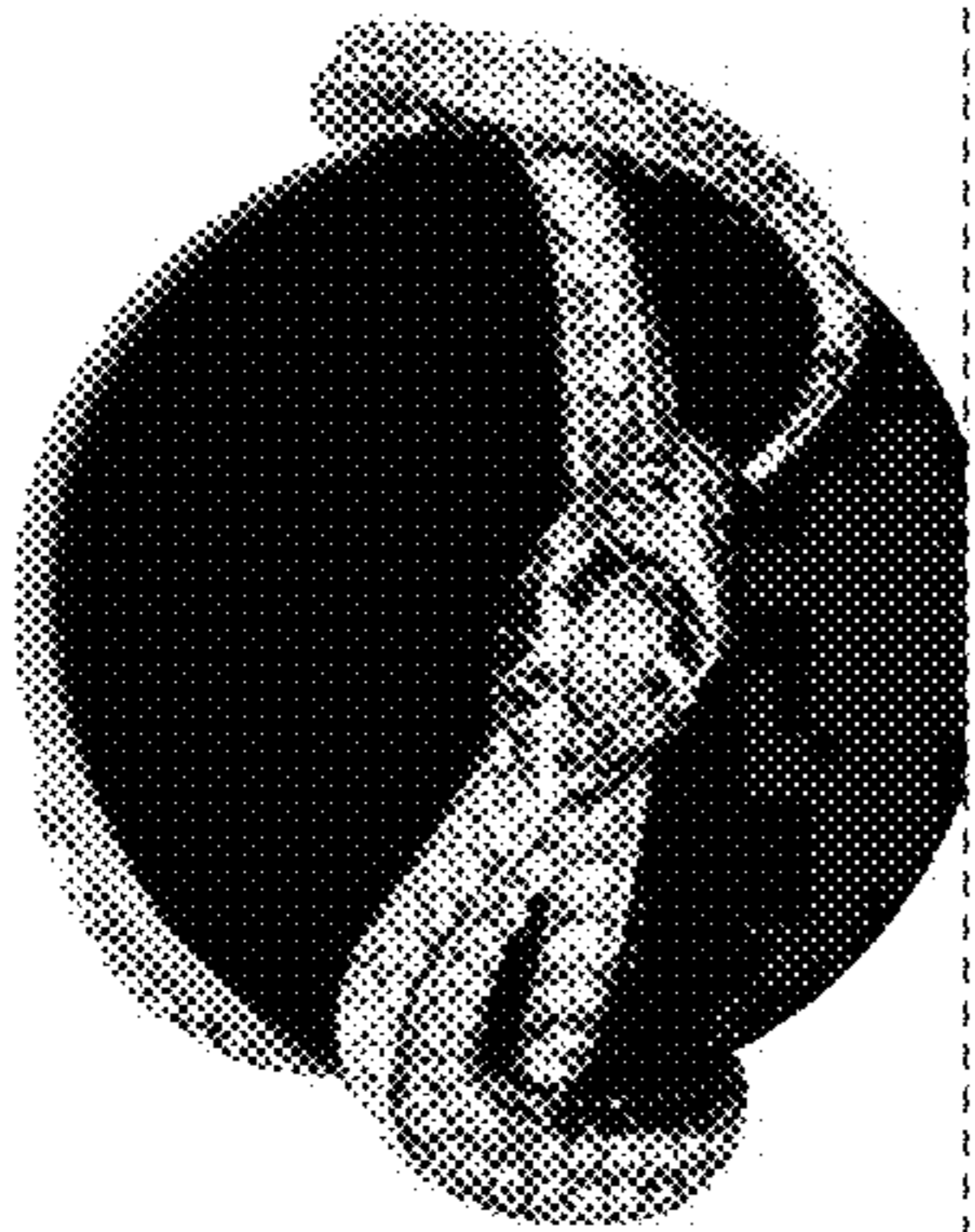

FIG. 2

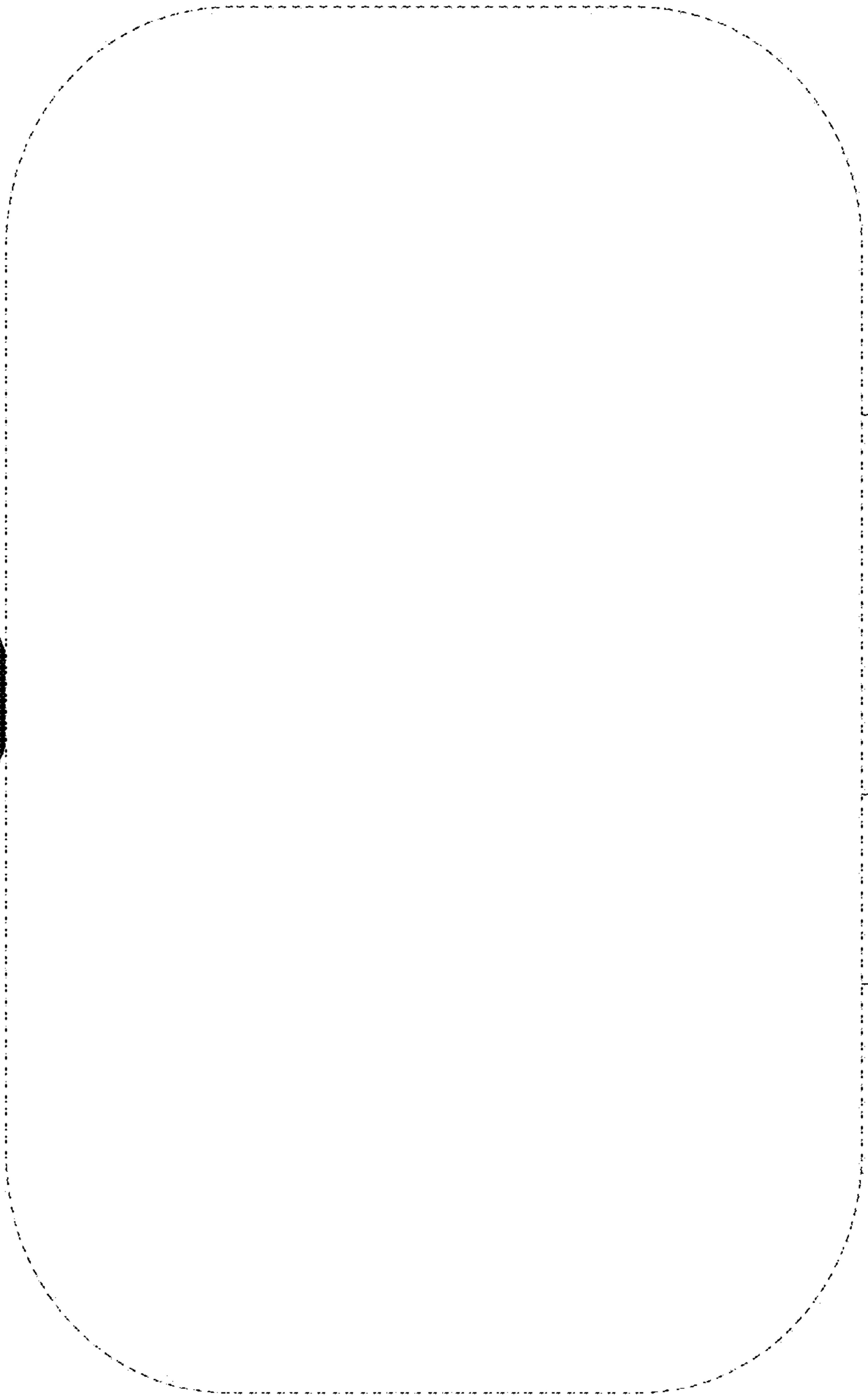
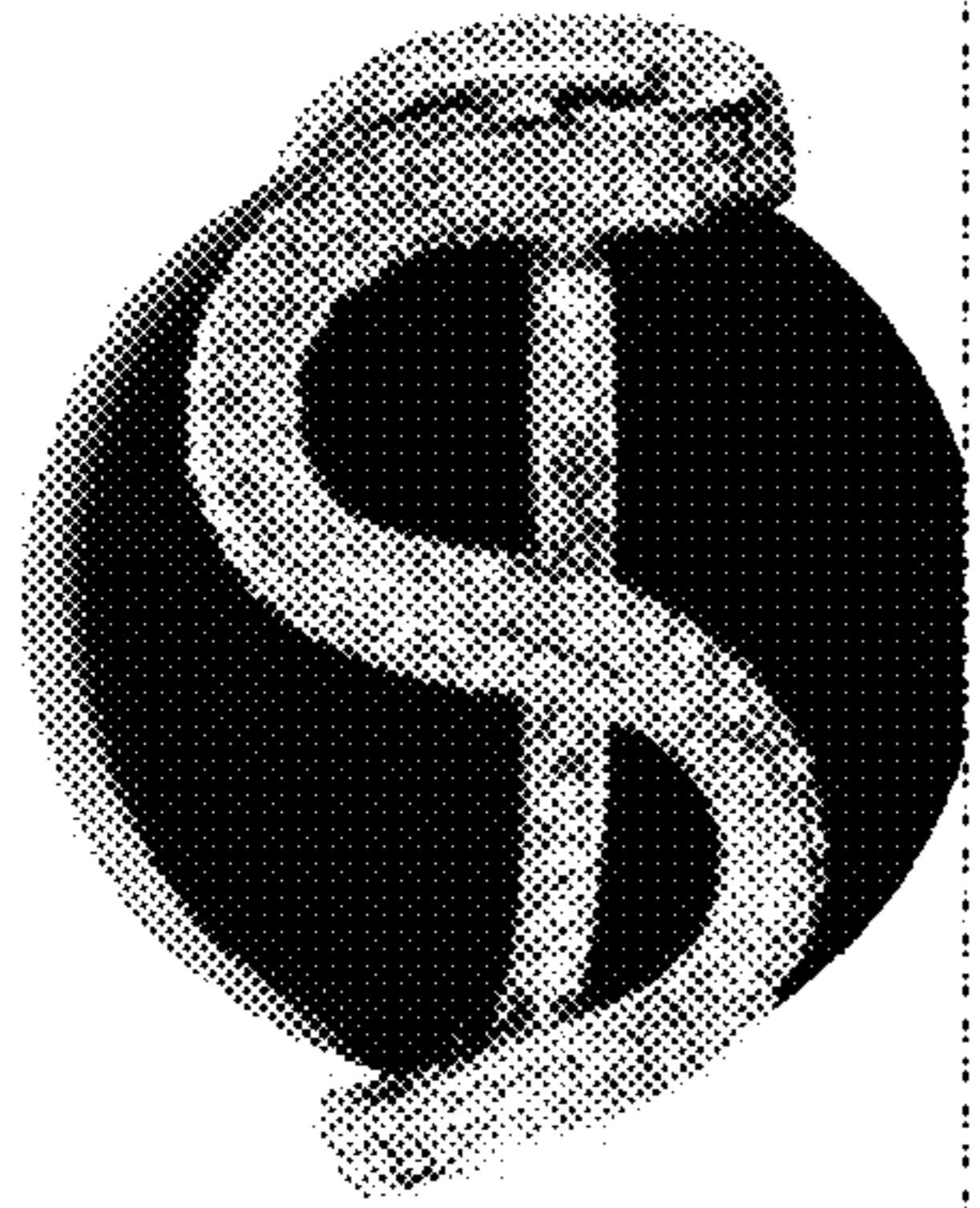

FIG. 3

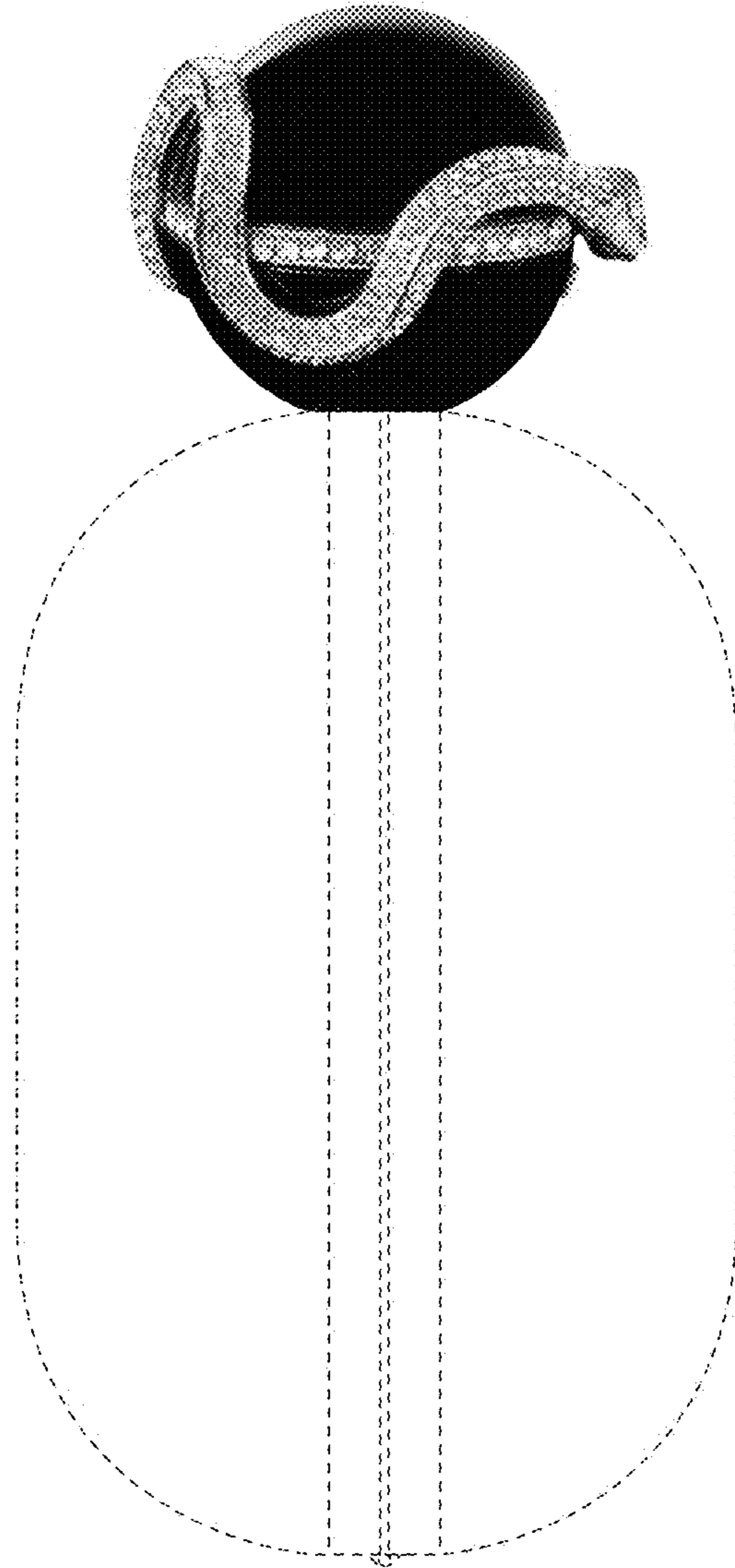

FIG. 4

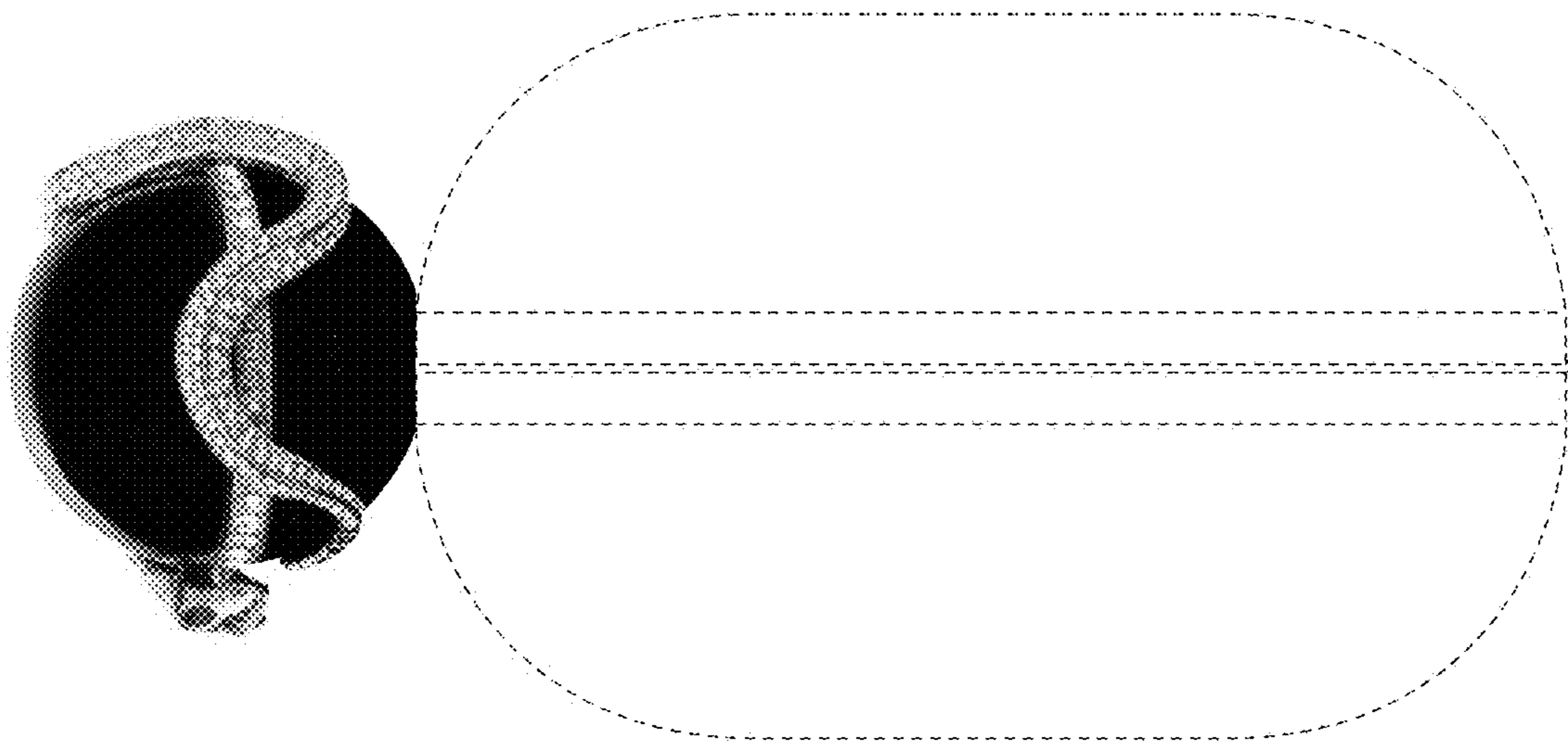

FIG. 5

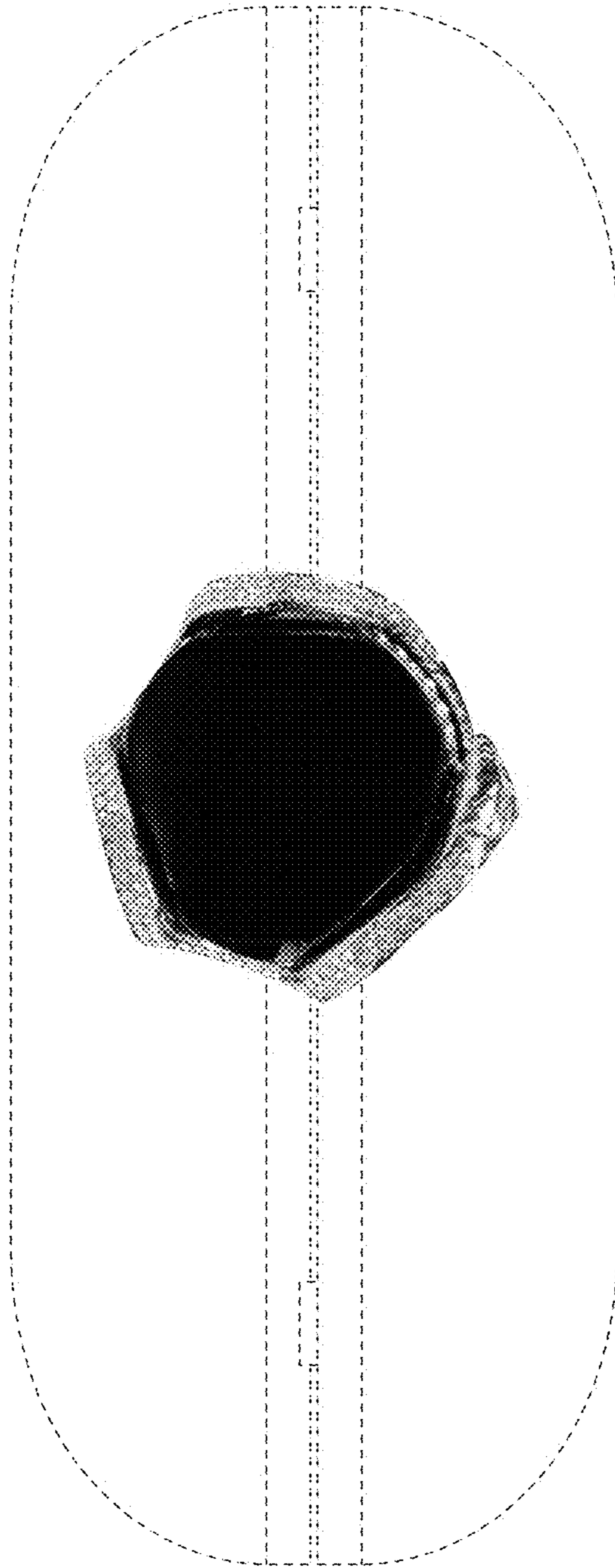

FIG. 6

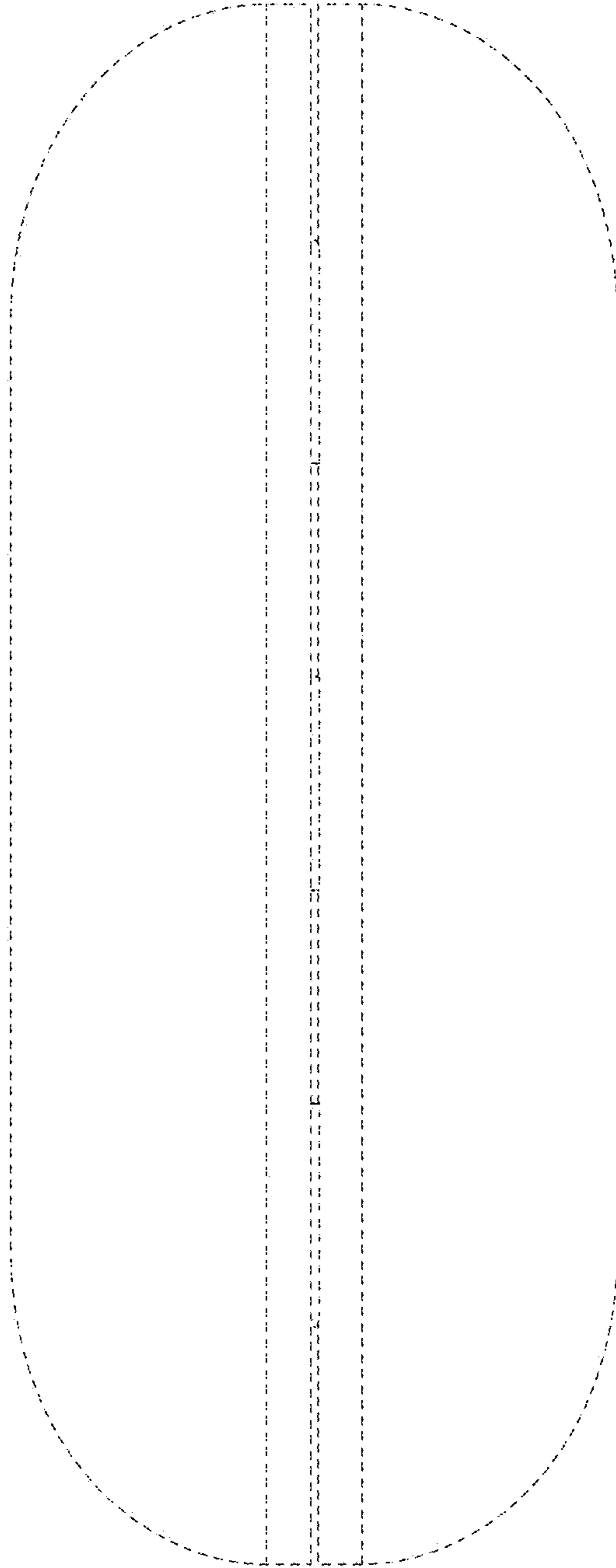

FIG. 7