



US00D966700S

(12) **United States Design Patent** (10) **Patent No.:** **US D966,700 S**
Ye (45) **Date of Patent:** **** Oct. 18, 2022**

(54) **HANDBAG**
(71) Applicant: **Liangyan Ye**, Ningde (CN)
(72) Inventor: **Liangyan Ye**, Ningde (CN)
(**) Term: **15 Years**
(21) Appl. No.: **29/740,506**
(22) Filed: **Jul. 5, 2020**
(51) **LOC (13) Cl.** **03-01**
(52) **U.S. Cl.**
USPC **D3/243**
(58) **Field of Classification Search**
USPC D3/232–233, 243, 245–246, 318, 322,
D3/327
CPC A45C 11/20; A45C 3/00; A45C 3/001;
A45C 13/26; A45C 3/06
See application file for complete search history.

D802,299 S * 11/2017 Sassi D3/246
D817,637 S * 5/2018 Fusi D3/246
D847,495 S * 5/2019 Zhang D3/218
D855,976 S * 8/2019 Sassi D3/232
D855,981 S * 8/2019 Vickery D3/243
D856,666 S * 8/2019 Marzin D3/232
D864,562 S * 10/2019 Sassi D3/243
D880,159 S * 4/2020 Fenton D3/303
D884,348 S * 5/2020 Zhou D3/318
D912,396 S * 3/2021 Rooker D3/218
D922,771 S * 6/2021 Della Valle D3/318

(56) **References Cited**
U.S. PATENT DOCUMENTS
2,308,003 A * 1/1943 Gamrod A45C 11/38
294/139
D307,673 S * 5/1990 Brown 224/240
5,771,951 A * 6/1998 Bihn A47F 5/0807
150/108
D396,554 S * 8/1998 Roeder D3/232
D429,881 S * 8/2000 Gray D3/215
6,123,240 A * 9/2000 Fowles A45C 1/04
224/219
D520,234 S * 5/2006 Schmitt D3/243
D596,397 S * 7/2009 Novak D3/245
D619,432 S * 7/2010 LaBonte D7/709
D655,583 S * 3/2012 Palazzolo D7/709
D658,872 S * 5/2012 Schiffman D3/243
D757,428 S * 5/2016 Spaziani D3/243
D762,060 S * 7/2016 Adio D3/243
D762,062 S * 7/2016 Spaziani D3/243
D769,625 S * 10/2016 Sassi D3/322

OTHER PUBLICATIONS

“Mini LV Jelly Bags”, klolaaccessories.com, site visited Oct. 12, 2021: <https://www.klolaaccessories.com/product/mini-lv-jelly-bags> (Year: 2021).*

(Continued)

Primary Examiner — Jennifer L Watkins
Assistant Examiner — Samantha Lynne Brodowski
(74) *Attorney, Agent, or Firm* — Justin Lampel

(57) **CLAIM**
The ornamental design for a handbag, as shown and described.

DESCRIPTION

FIG. 1 is a perspective view of a handbag showing my new design;
FIG. 2 is a top plan view thereof;
FIG. 3 is a left side view thereof;
FIG. 4 is a front elevational view thereof;
FIG. 5 is a right side view thereof;
FIG. 6 is a rear elevational view thereof; and,
FIG. 7 is a bottom plan view thereof.
The broken lines in the drawings depict portions of the article that form no part of the claimed design.

1 Claim, 7 Drawing Sheets

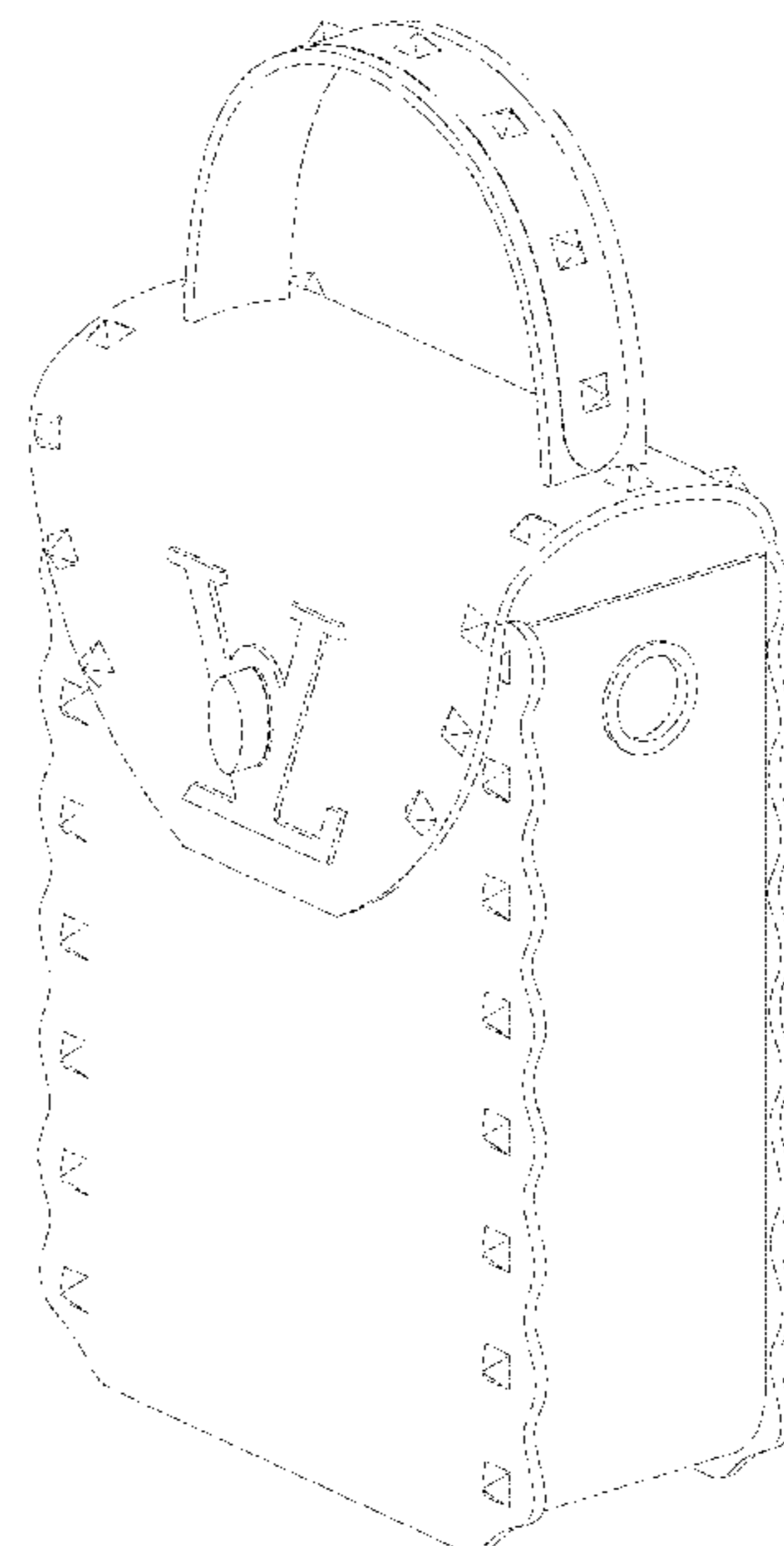

(56)

References Cited

OTHER PUBLICATIONS

“Wholesale 2021 New Designer Pvc Jelly Phone Bag Hand Bag Sets Ladies Handbags Women Matching Headband And Purses Handbags Set”, Alibaba.com, site visited Oct. 12, 2021: https://www.alibaba.com/product-detail/Wholesale-2021-New-Designer-Pvc-Jelly_1600237656147.html (Year: 2021).*

“2021 Fashion Bags Ladies Mobile Cell Phone Bag Mini Wallet High Quality Designer Jelly Crossbody Bags for Women Single”, Shopee.co.th, site visited Oct. 12, 2021: <https://shopee.co.th/2021-Fashion-Bags-Ladies-Mobile-Cell-Phone-Bag-Mini-Wallet-High-Quality-Designer-Jelly-Crossbody-Bags-for-Women-Single-i.451772065.5391933276> (Year: 2021).*

“Candy jelly bag pvc Mobile phone bag Chain mini square bag small bag coin purse shoulder Crossbody bag Sac a Main Femme”, first reviewed Apr. 20, 2021, AliExpress.com, site visited Oct. 12, 2021: <https://www.aliexpress.com/item/4001184541335.html> (Year: 2021).*

“New Fashion Jelly Bag Rivet Phone Handbag Mini Chain Crossbody Bag for Women Messenger Bags Ladies Crossbody Purse”, first reviewed Jun. 16, 2021, AliExpress.com, site visited Oct. 12, 2021: <https://www.aliexpress.com/item/4001235338067.html?spm=a2g0o.12057483.product-detail-btn.1.5e585a16036SSy> (Year: 2021).*

“Rainbow Color Cellphone Holder Jelly Bag”, mezonhandbag.com, site visited Oct. 12, 2021: <https://www.mezonhandbags.com/fashion-rainbow-color-pvc-mini-phone-holder-jelly-purses-bag.html> (Year: 2021).*

* cited by examiner

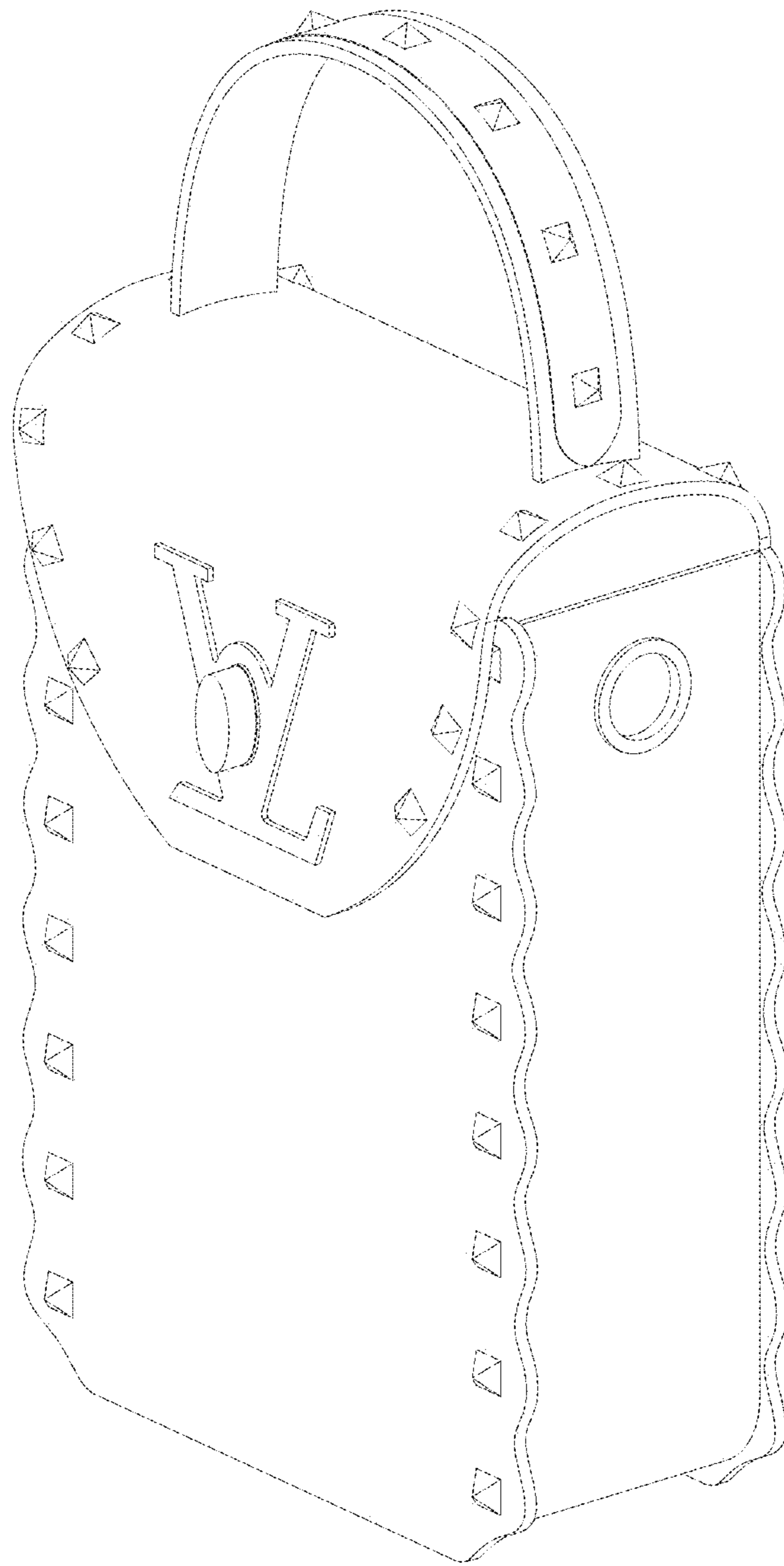

FIG.1

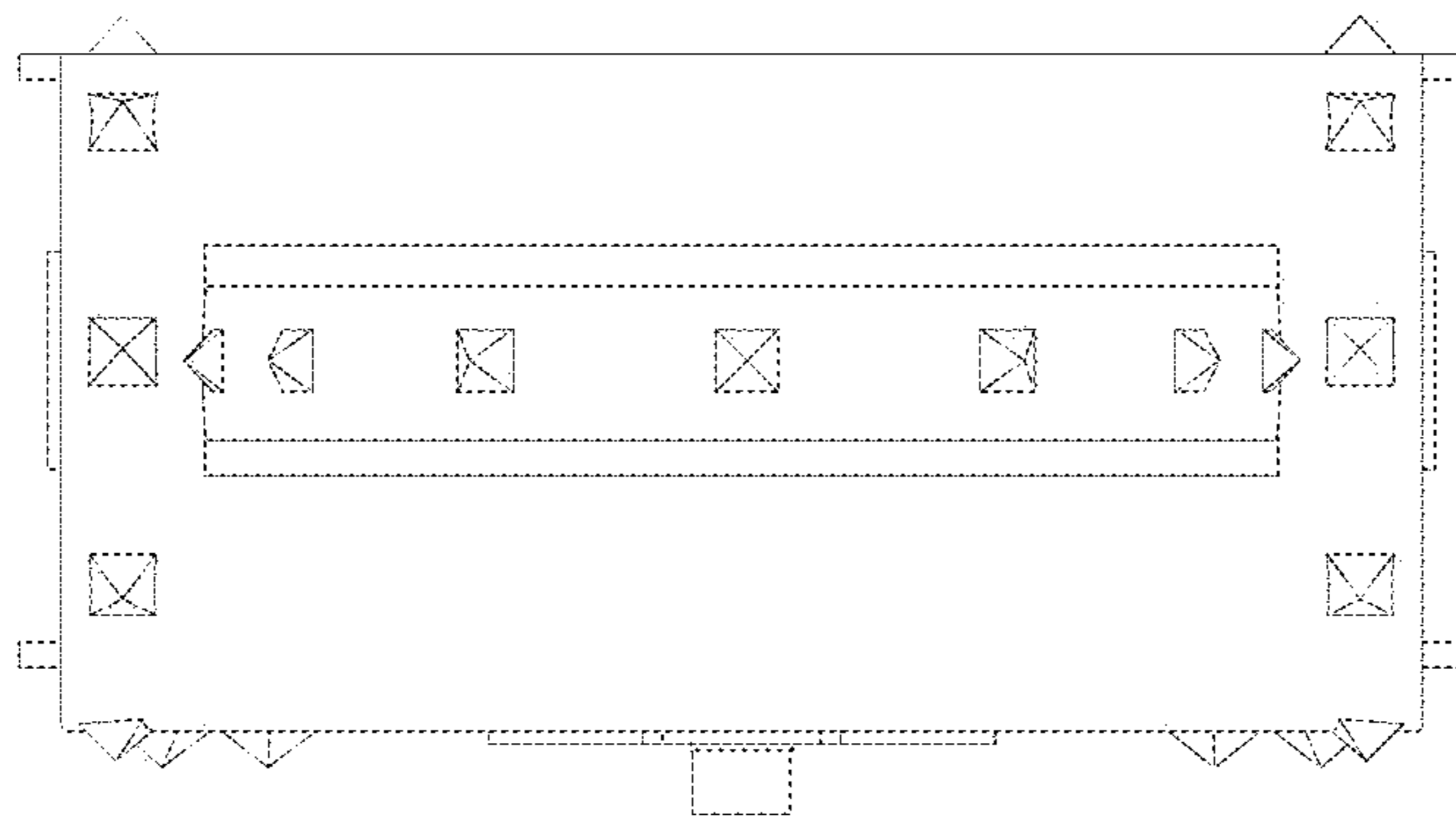

FIG.2

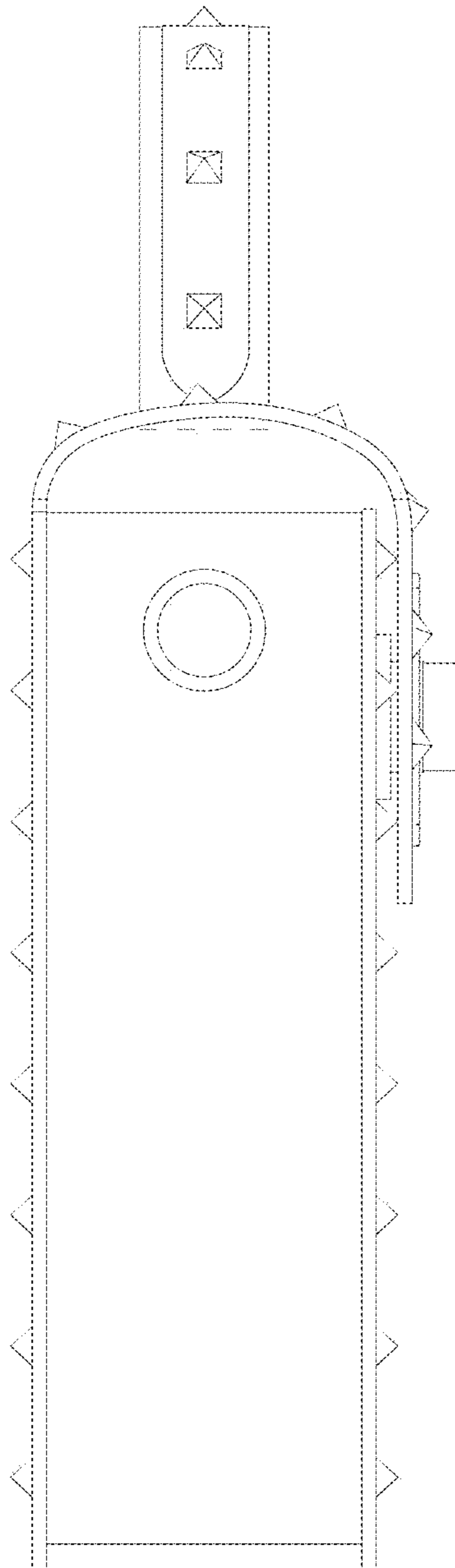

FIG.3

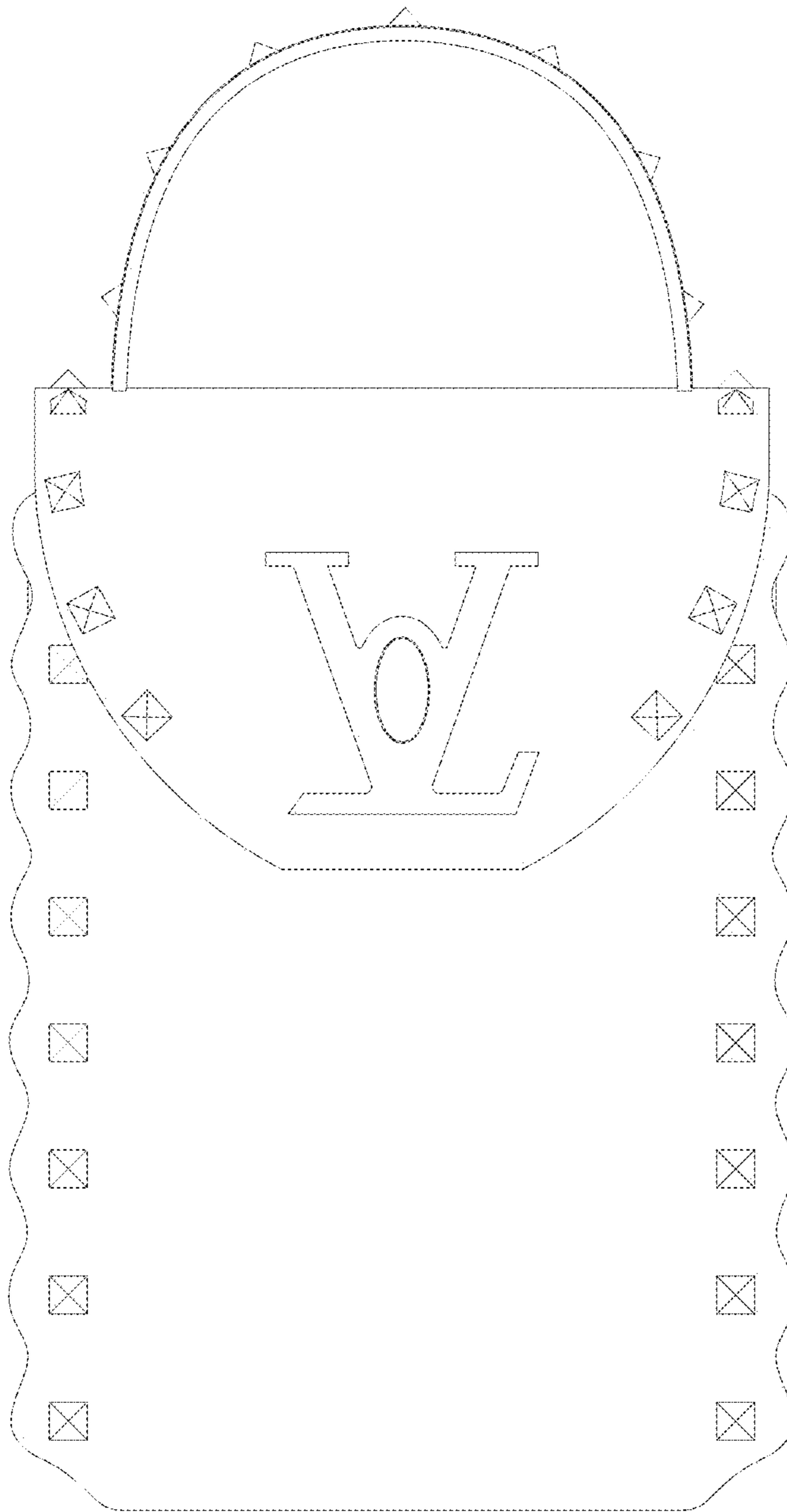

FIG.4

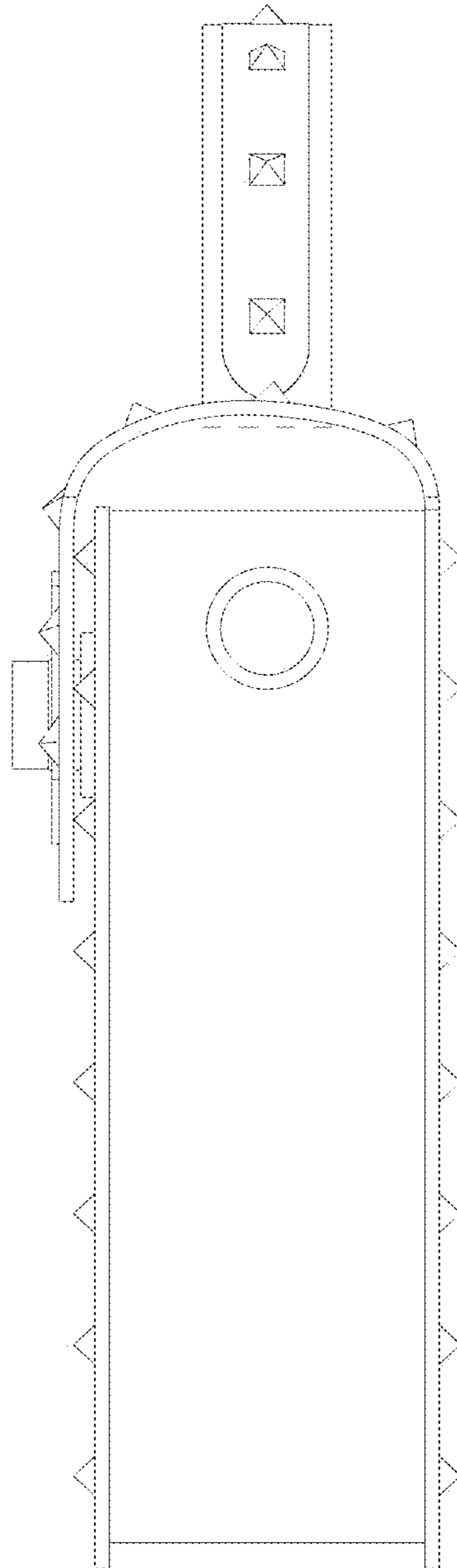

FIG. 5

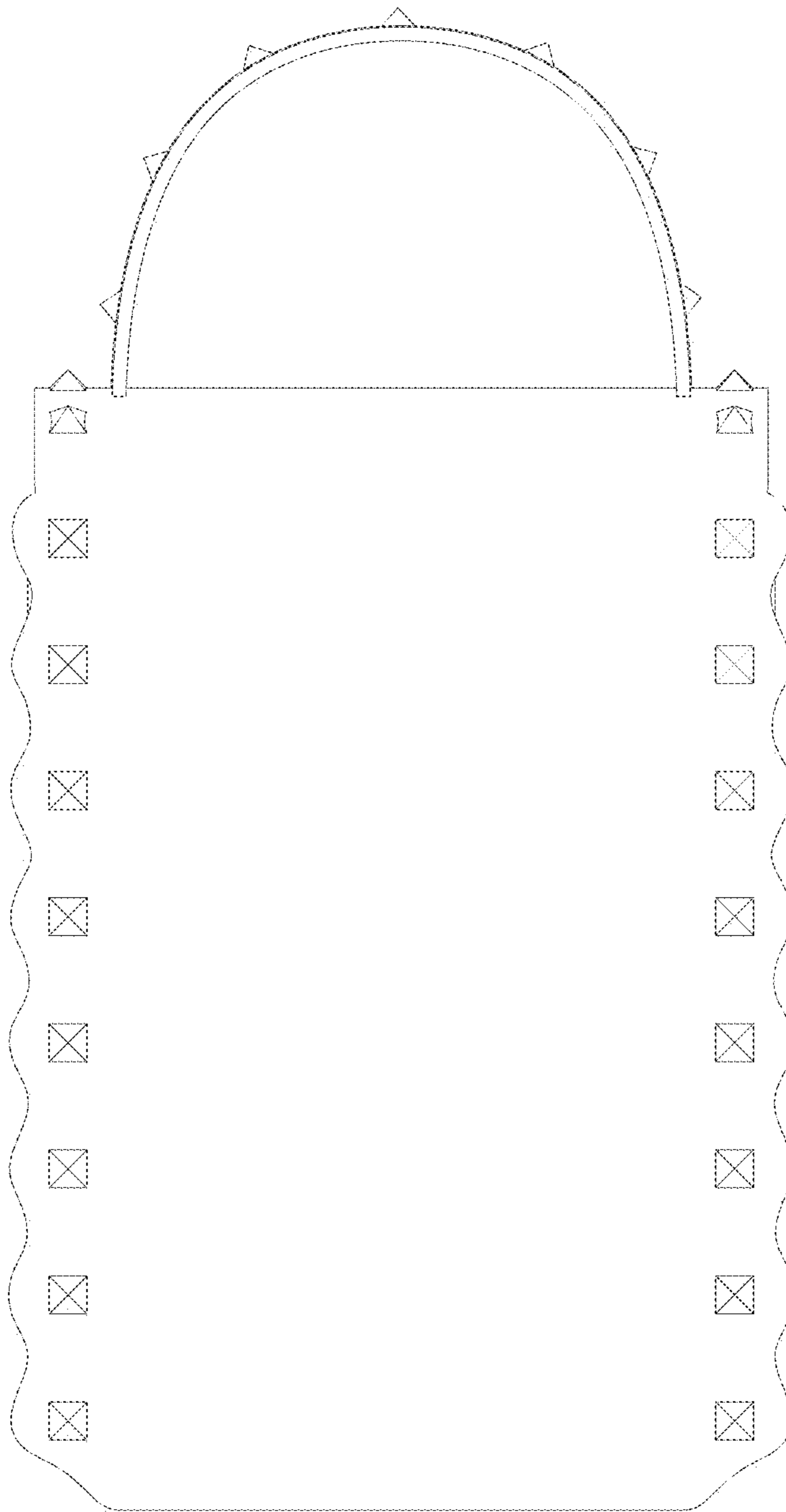

FIG.6

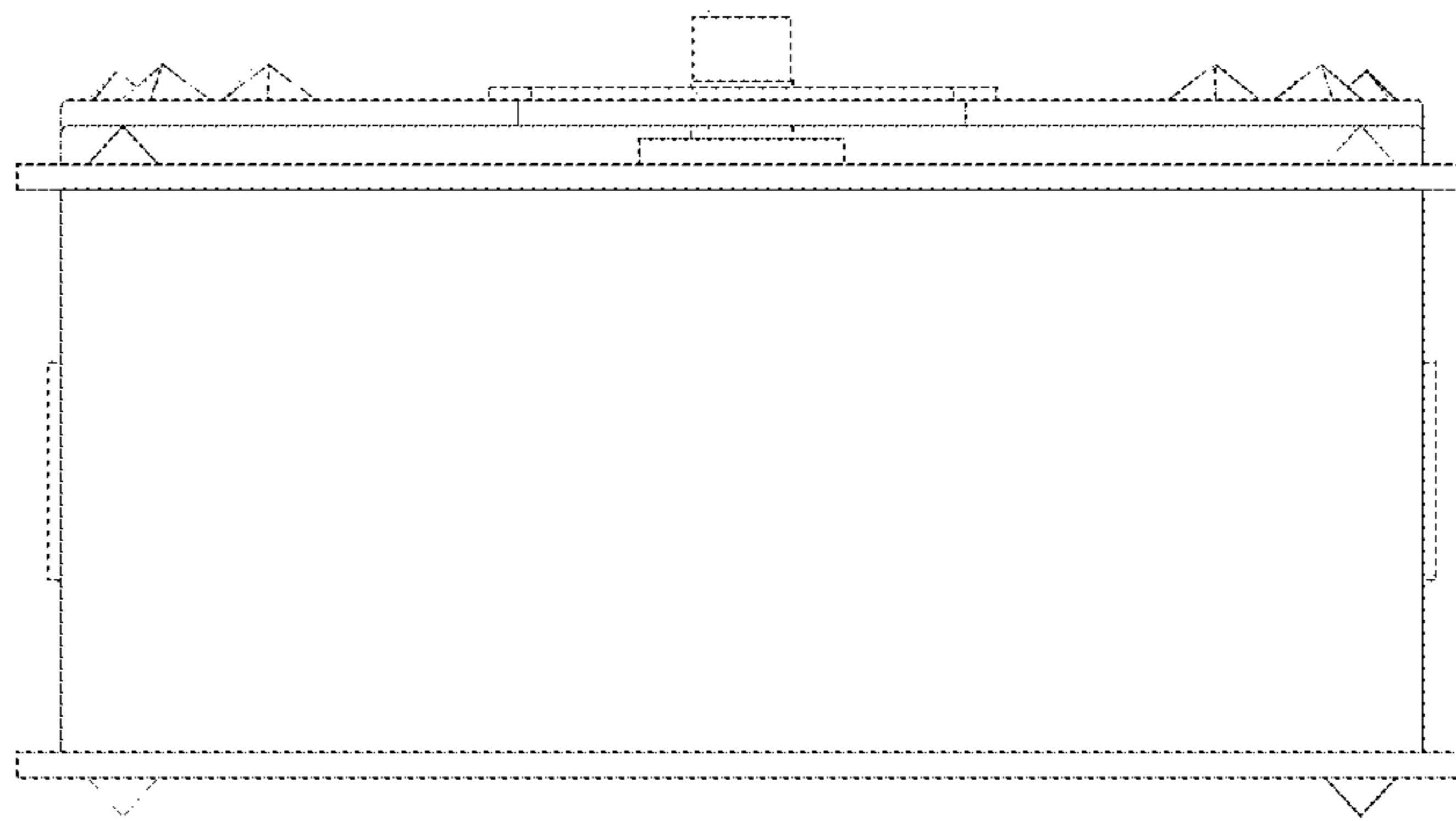

FIG. 7