



US00D966654S

(12) **United States Design Patent**  
**Lockhart**

(10) **Patent No.:** **US D966,654 S**  
(45) **Date of Patent:** **\*\* Oct. 18, 2022**

(54) **PANTS WITH POCKETS**

- (71) Applicant: **Gloria Ewing Lockhart**, San Pedro, CA (US)
- (72) Inventor: **Gloria Ewing Lockhart**, San Pedro, CA (US)
- (\*\*) Term: **15 Years**
- (21) Appl. No.: **29/767,710**
- (22) Filed: **Jan. 25, 2021**
- (51) **LOC (13) Cl.** ..... **02-02**
- (52) **U.S. Cl.**  
USPC ..... **D2/742**
- (58) **Field of Classification Search**  
USPC ..... D2/742, 745, 748, 853, 857  
CPC ..... A41D 1/06  
See application file for complete search history.

(56) **References Cited**

**U.S. PATENT DOCUMENTS**

D635,331 S *	4/2011	Eckman	.....	D2/742
D736,495 S *	8/2015	Bednarz	.....	D2/742
D787,784 S *	5/2017	Lago	.....	D2/742
D801,000 S *	10/2017	Barnabe	.....	D2/742
D825,890 S *	8/2018	Scott	.....	D2/742
D848,709 S *	5/2019	Bankole	.....	D2/742
D885,010 S *	5/2020	Macklin	.....	D2/742
D887,108 S *	6/2020	Pieniazek	.....	D2/742
D935,738 S *	11/2021	Freddi	.....	D2/742
2013/0254969 A1 *	10/2013	Getzen	.....	A41B 1/10
				2/108
2020/0180263 A1 *	6/2020	Roup	.....	B32B 5/026

**OTHER PUBLICATIONS**

Original 874 Work Pants, reviewed early as 2015 [online], (retrieved Jan. 26, 2022). Retrieved from the internet, <https://www.dickies.com/pants/original-874-work-pants/874.html> (Year: 2015).\*

24-7 Series Classic Pants with Hidden Cargo Pockets, reviewed Jun. 26, 2011 [online], (retrieved Jan. 26, 2022). Retrieved from the internet, <https://www.harrysarmysurplus.net/truspec-24-7-classic-pant.html> (Year: 2011).\*

\* cited by examiner

*Primary Examiner* — Kevin K Rudzinski

*Assistant Examiner* — J. Thorn, Sr.

(74) *Attorney, Agent, or Firm* — Elizabeth Yang

(57) **CLAIM**

The ornamental design for a pants with pockets, as shown and described.

**DESCRIPTION**

FIG. 1 is the perspective view of a pants with pockets;  
 FIG. 2 is the front view thereof;  
 FIG. 3 is the rear view thereof;  
 FIG. 4 is the left side view thereof;  
 FIG. 5 is the right side view thereof;  
 FIG. 6 is the top view thereof;  
 FIG. 7 is the bottom view thereof; and,  
 FIG. 8 is the perspective view of the pants with pockets containing a zipper inside.  
 The broken lines in the drawings depict stitching and form no part of the claimed design.

**1 Claim, 6 Drawing Sheets**

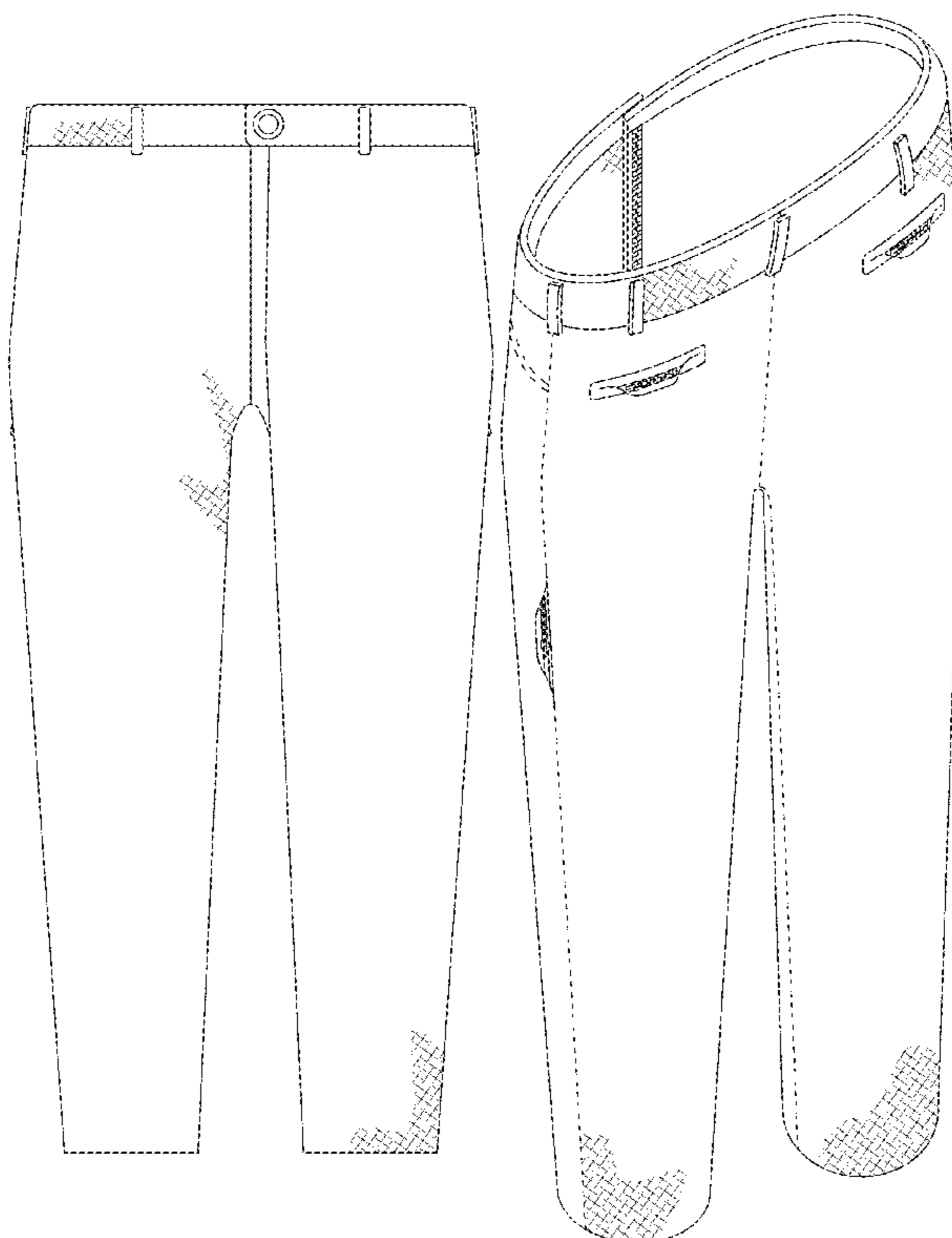

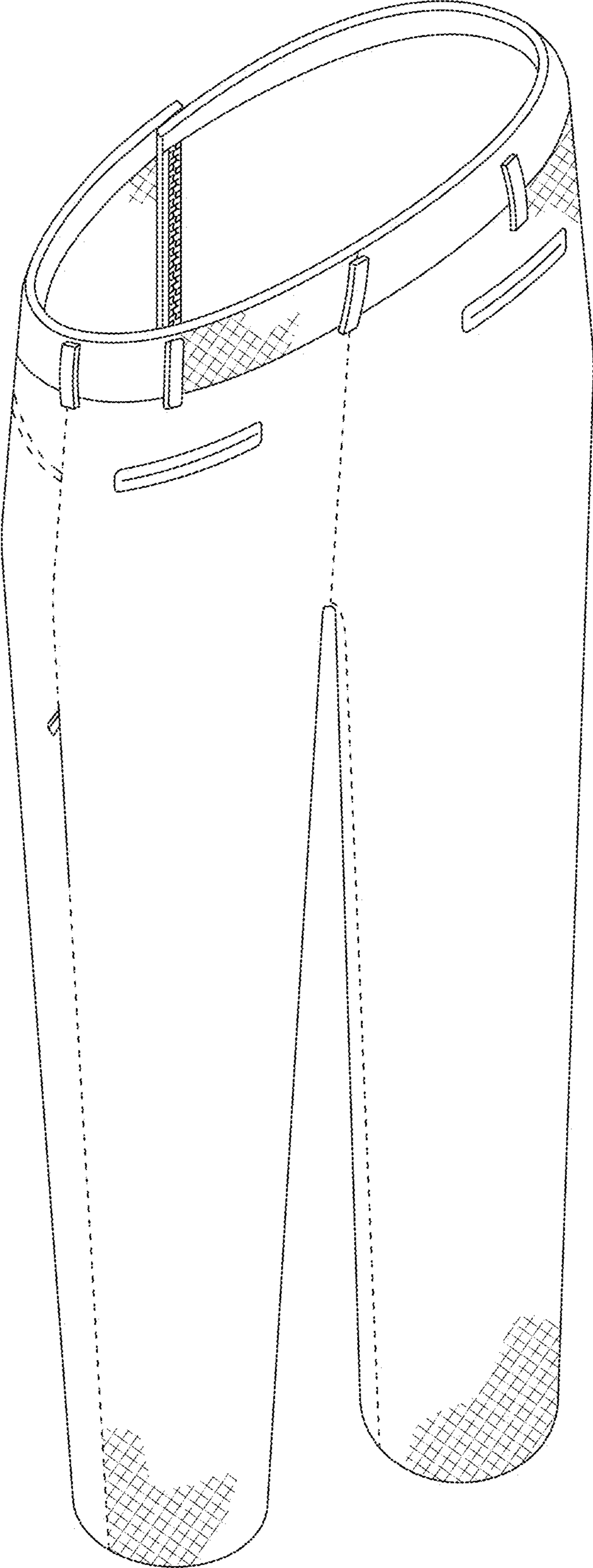

FIG. 1

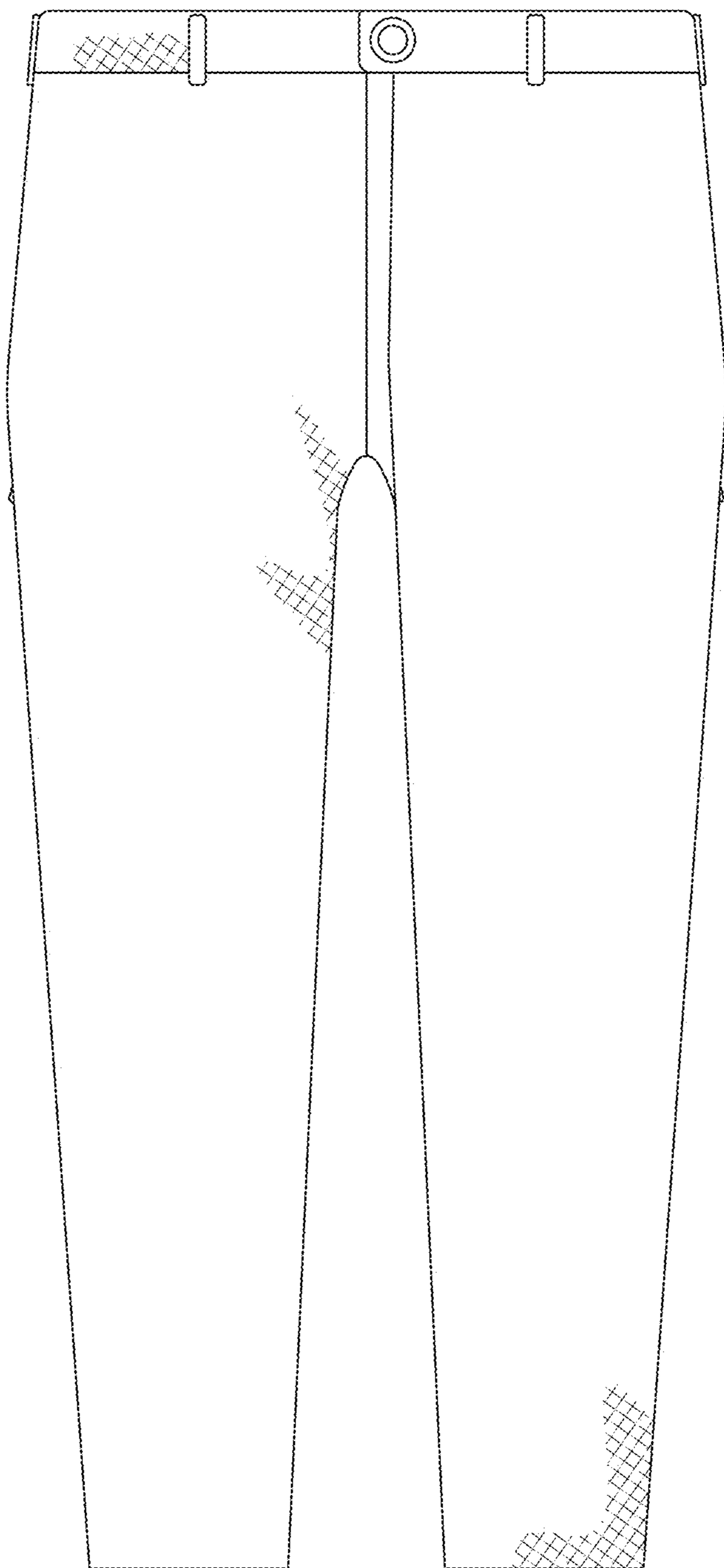

FIG. 2

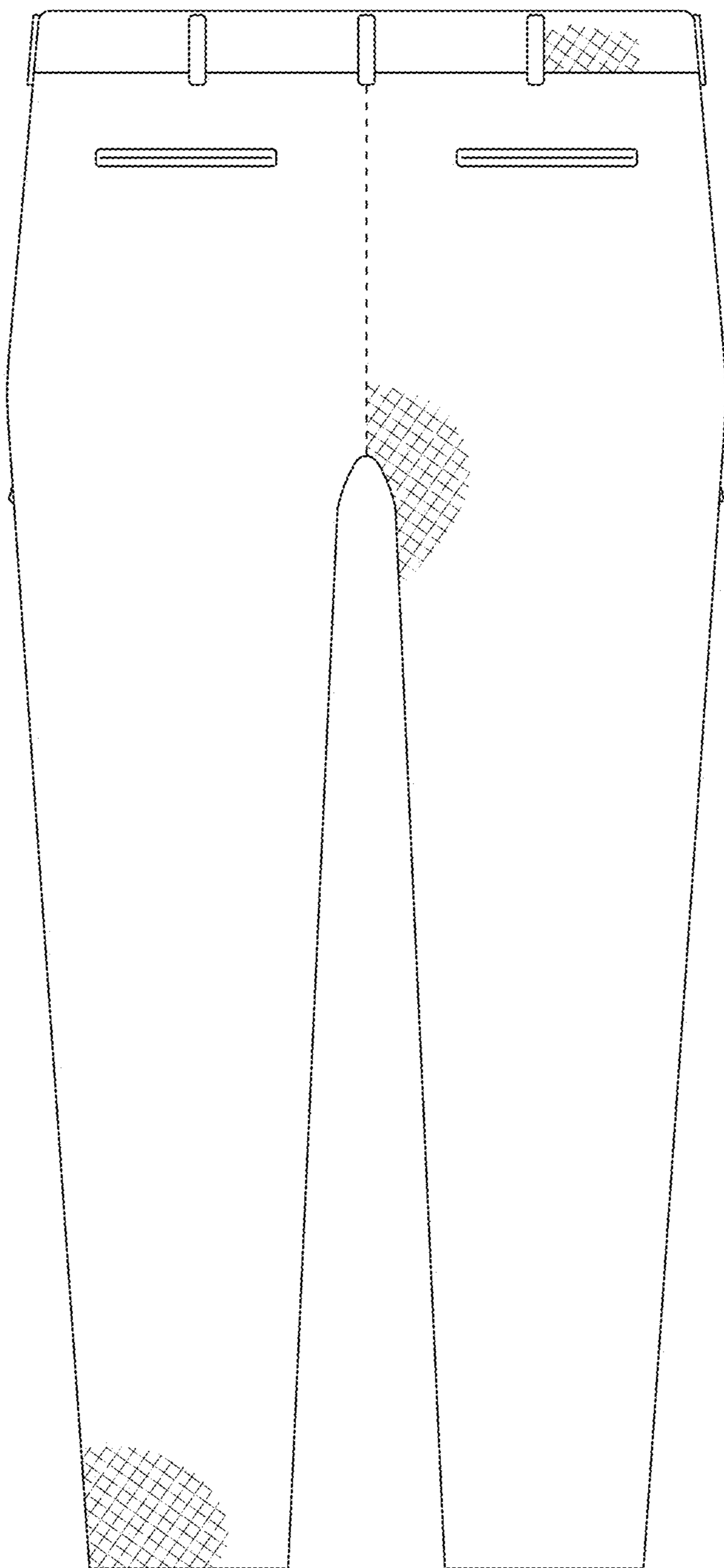

FIG. 3

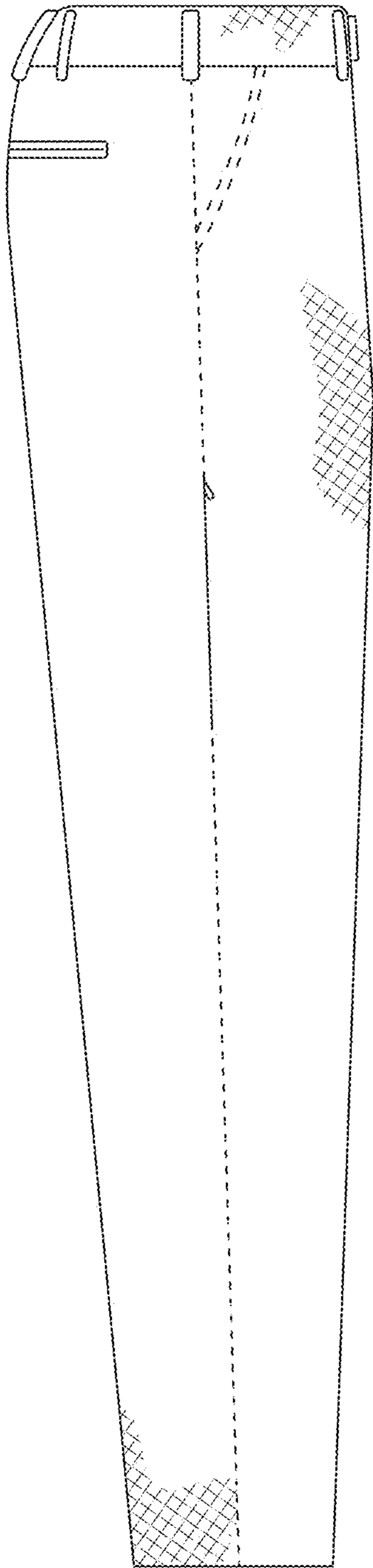

FIG. 4

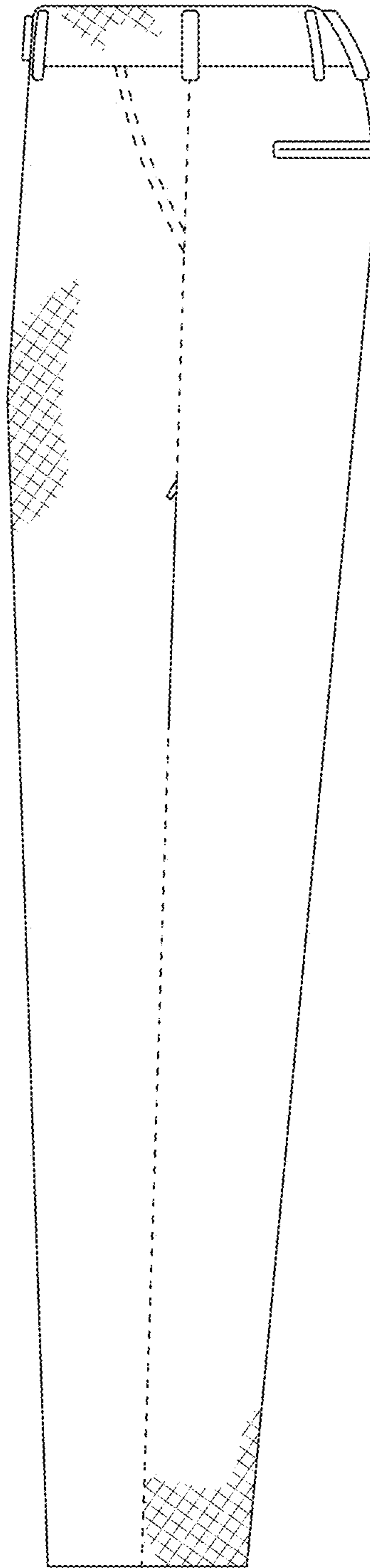

FIG. 5

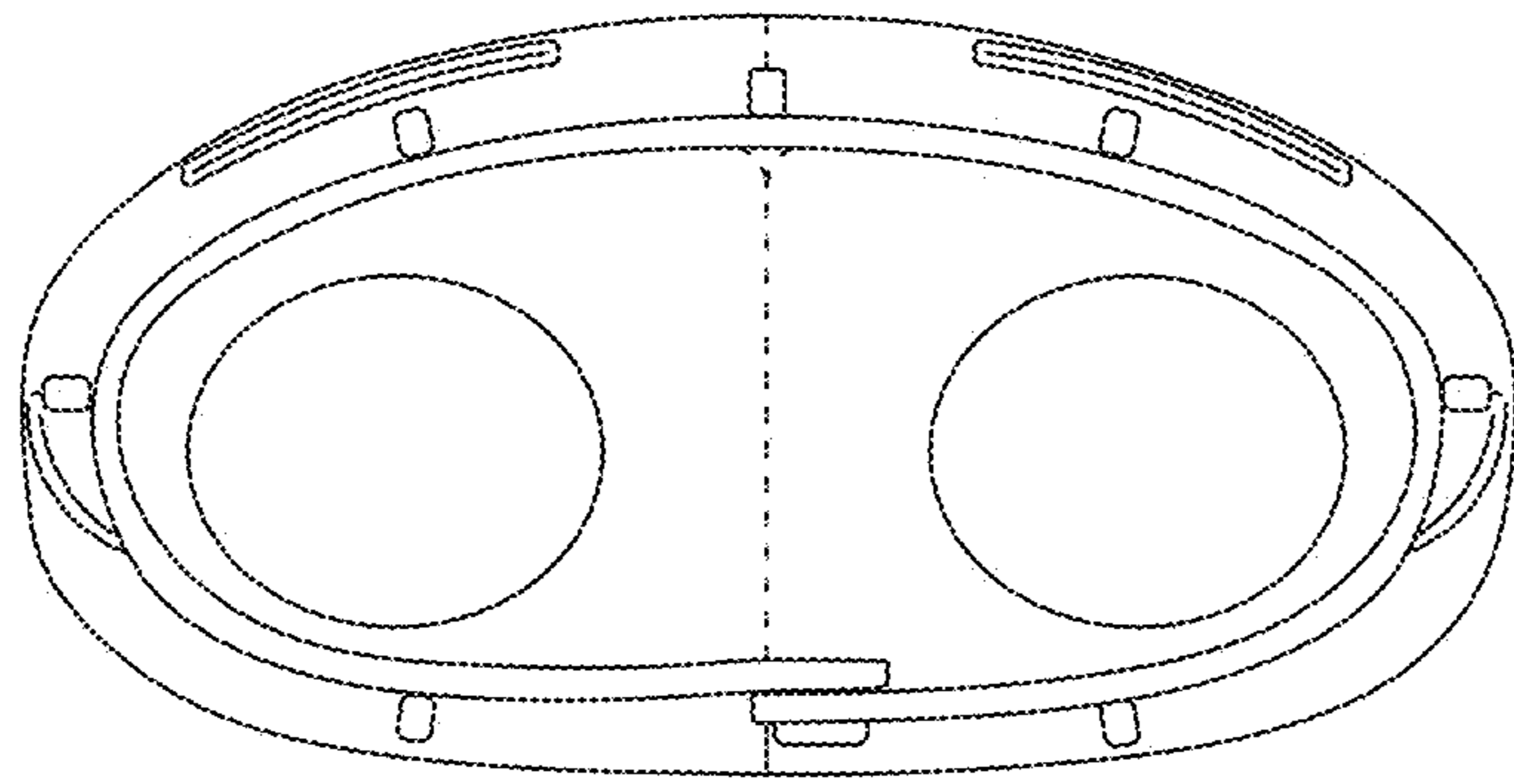

FIG. 6

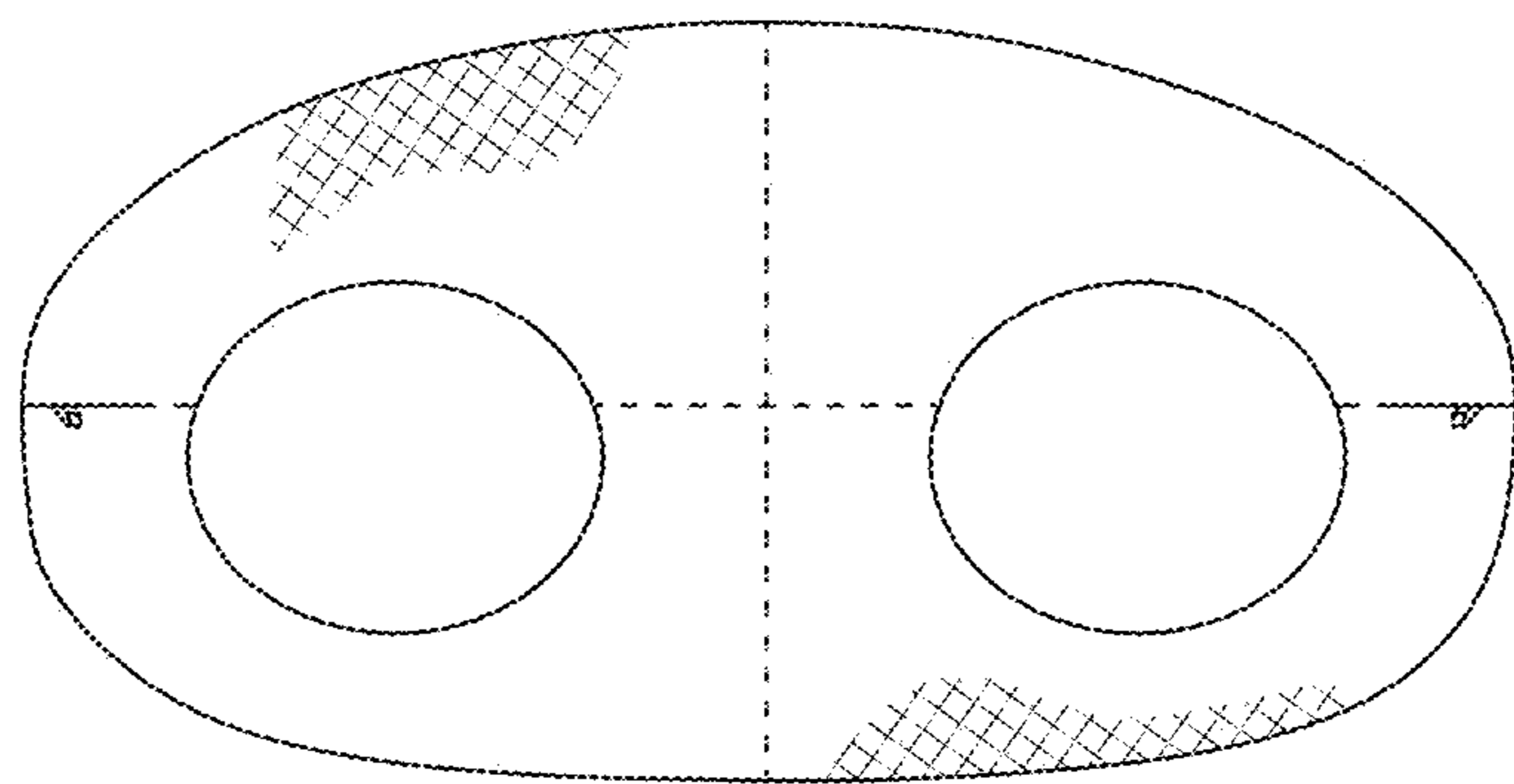

FIG. 7

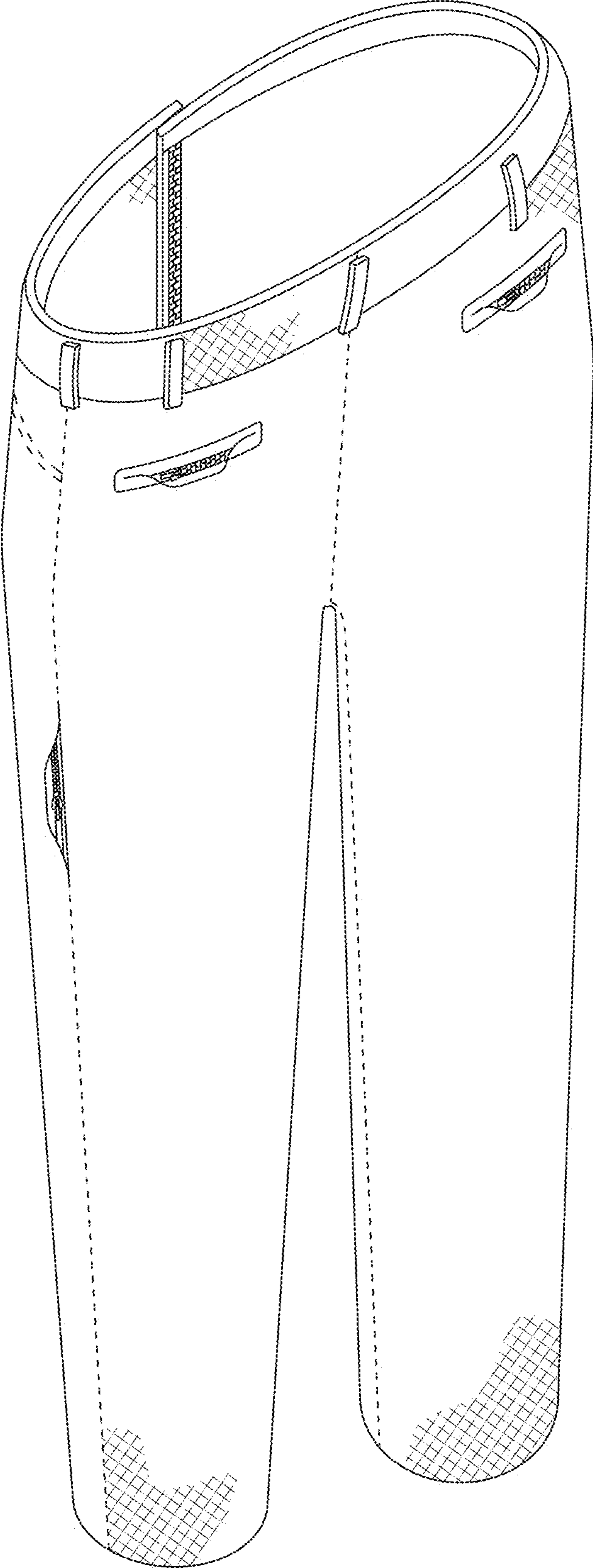

FIG. 8