



US00D966605S

(12) **United States Design Patent** (10) **Patent No.:** **US D966,605 S**
Yang (45) **Date of Patent:** **** Oct. 11, 2022**

(54) **TRAVEL CIGAR HUMIDOR CASE**

(71) Applicant: **Qian Yang**, Hunan (CN)

(72) Inventor: **Qian Yang**, Hunan (CN)

(**) Term: **15 Years**

(21) Appl. No.: **29/750,982**

(22) Filed: **Sep. 17, 2020**

(51) **LOC (13) Cl.** **27-06**

(52) **U.S. Cl.**
USPC **D27/189**

(58) **Field of Classification Search**
USPC D27/127, 186-189, 183, 172; D3/201,
D3/202.1, 205, 211, 232, 273, 274, 285,
D3/289, 294, 295, 301
CPC A24F 25/02; A24F 25/00
See application file for complete search history.

(56) **References Cited**

U.S. PATENT DOCUMENTS

5,692,605	A *	12/1997	Lai	A45C 11/16 217/60 E
D398,715	S *	9/1998	Descalzo	D27/189
D399,598	S *	10/1998	Perkins	D27/189
D414,891	S *	10/1999	Schmaling	D27/189
5,970,987	A *	10/1999	Barreiro, Jr.	A24F 25/02 312/31
5,975,288	A *	11/1999	Crowder	A24F 25/02 206/242
6,157,306	A *	12/2000	Mularoni	G08B 21/182 206/242
8,178,854	B1 *	5/2012	Elliott	A61L 2/10 312/231
D785,864	S *	5/2017	Showers	D27/185
D805,815	S *	12/2017	Leonorovitz	D6/667

D893,095	S *	8/2020	Ziering	D27/189
D910,912	S *	2/2021	Slate	D27/189
D918,030	S *	5/2021	Wan	D9/420
D941,140	S *	1/2022	Pincus	D9/420
2020/0037661	A1 *	2/2020	Slate	A24F 15/02

OTHER PUBLICATIONS

Portable Leather Cigar Humidor Case By: CiTree found on Amazon (Jan. 28, 2022) <https://www.amazon.com/CiTree-Humidor-Portable-Leather-Humidifier/dp/B0753G5ZGM> (Aug. 24, 2017).*

* cited by examiner

Primary Examiner — Rebecca Tsehaye
(74) *Attorney, Agent, or Firm* — ScienBiziP, P.C.

(57) **CLAIM**

The ornamental design for a travel cigar humidor case, as shown and described.

DESCRIPTION

FIG. 1 is a front and right perspective view of a travel cigar humidor case, showing my design.
FIG. 2 is a front elevation view thereof.
FIG. 3 is a rear elevation view thereof.
FIG. 4 is a left side elevation thereof.
FIG. 5 is a right side elevation thereof.
FIG. 6 is a top plan view thereof.
FIG. 7 is a bottom plan view thereof.
FIG. 8 is a perspective view of the travel cigar humidor case in an open state; and,
FIG. 9 is another perspective view of the travel cigar humidor case in an open state.
In the drawing, any singular broken lines illustrate stitching; All other double dashed lines depict unclaimed environmental objects and do not form part of the claim.

1 Claim, 9 Drawing Sheets

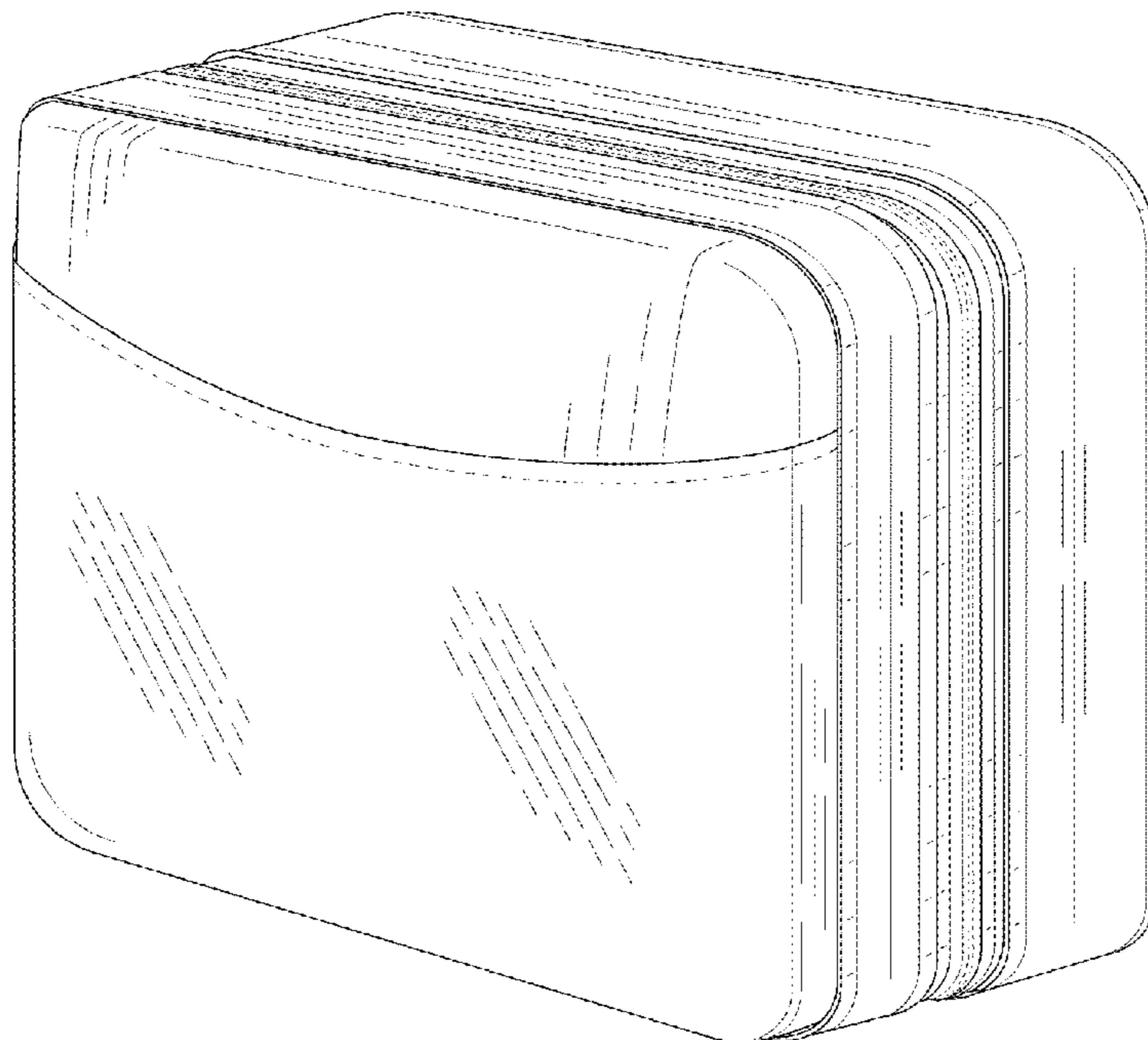

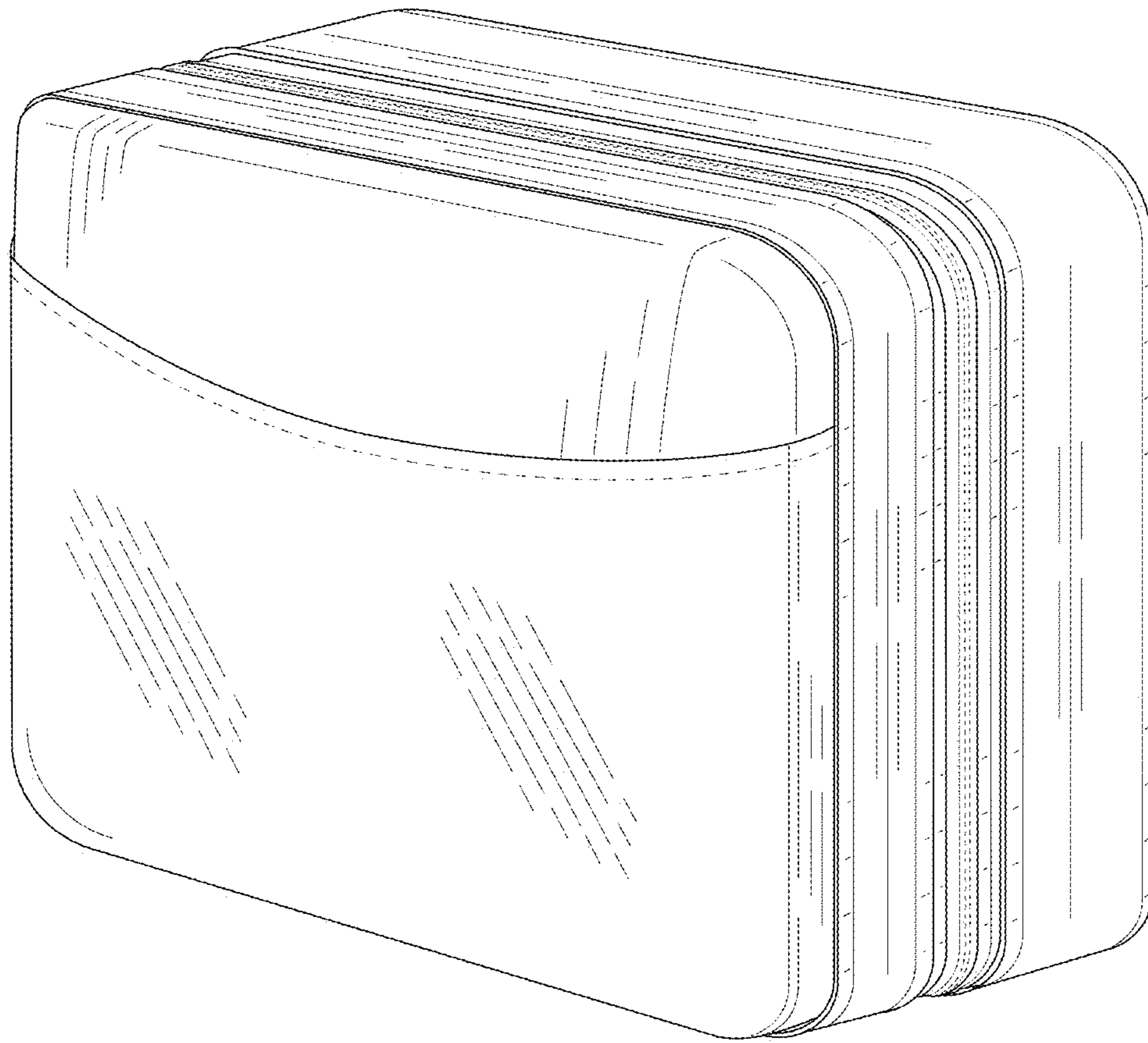

FIG. 1

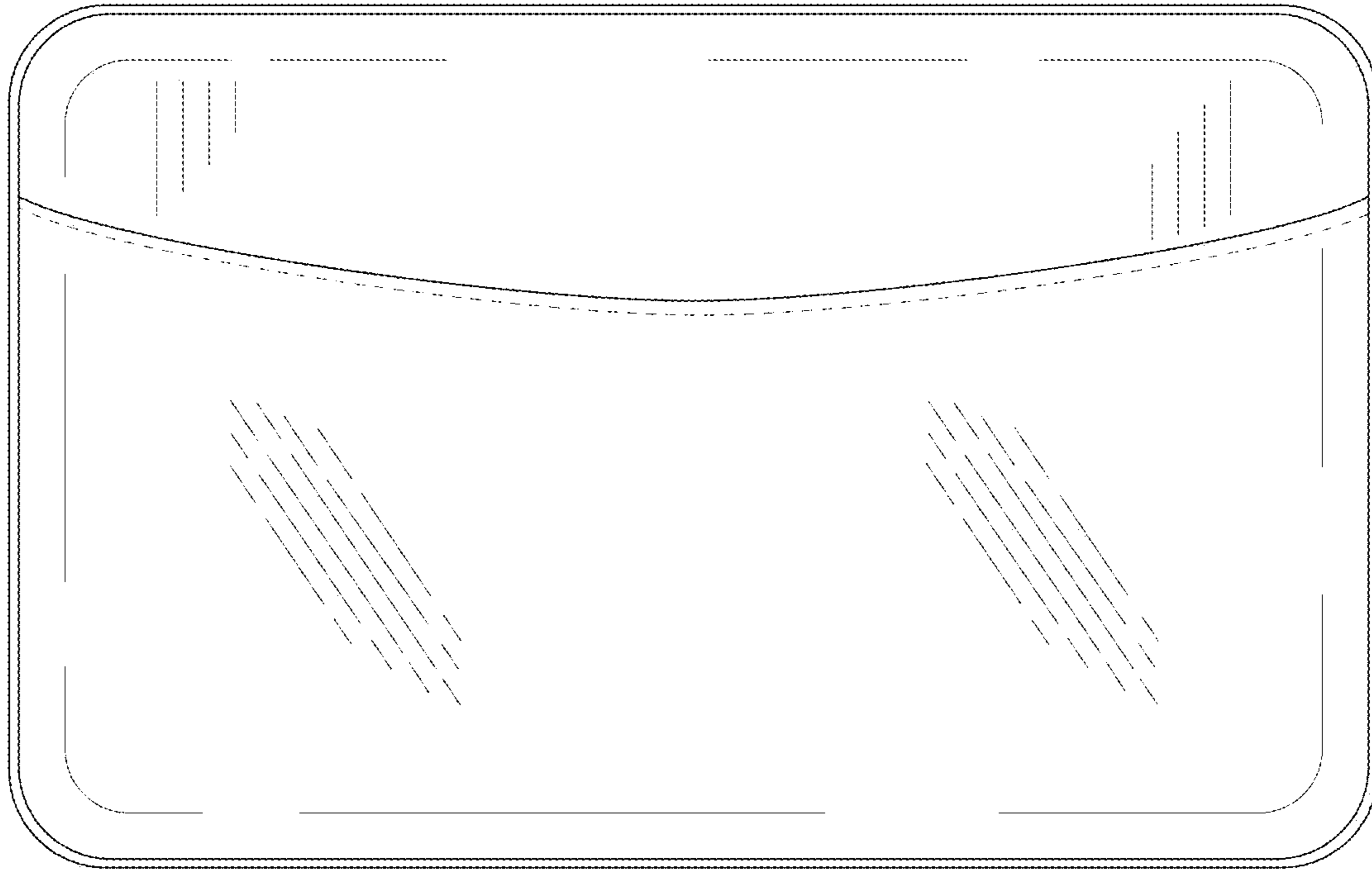

FIG.2

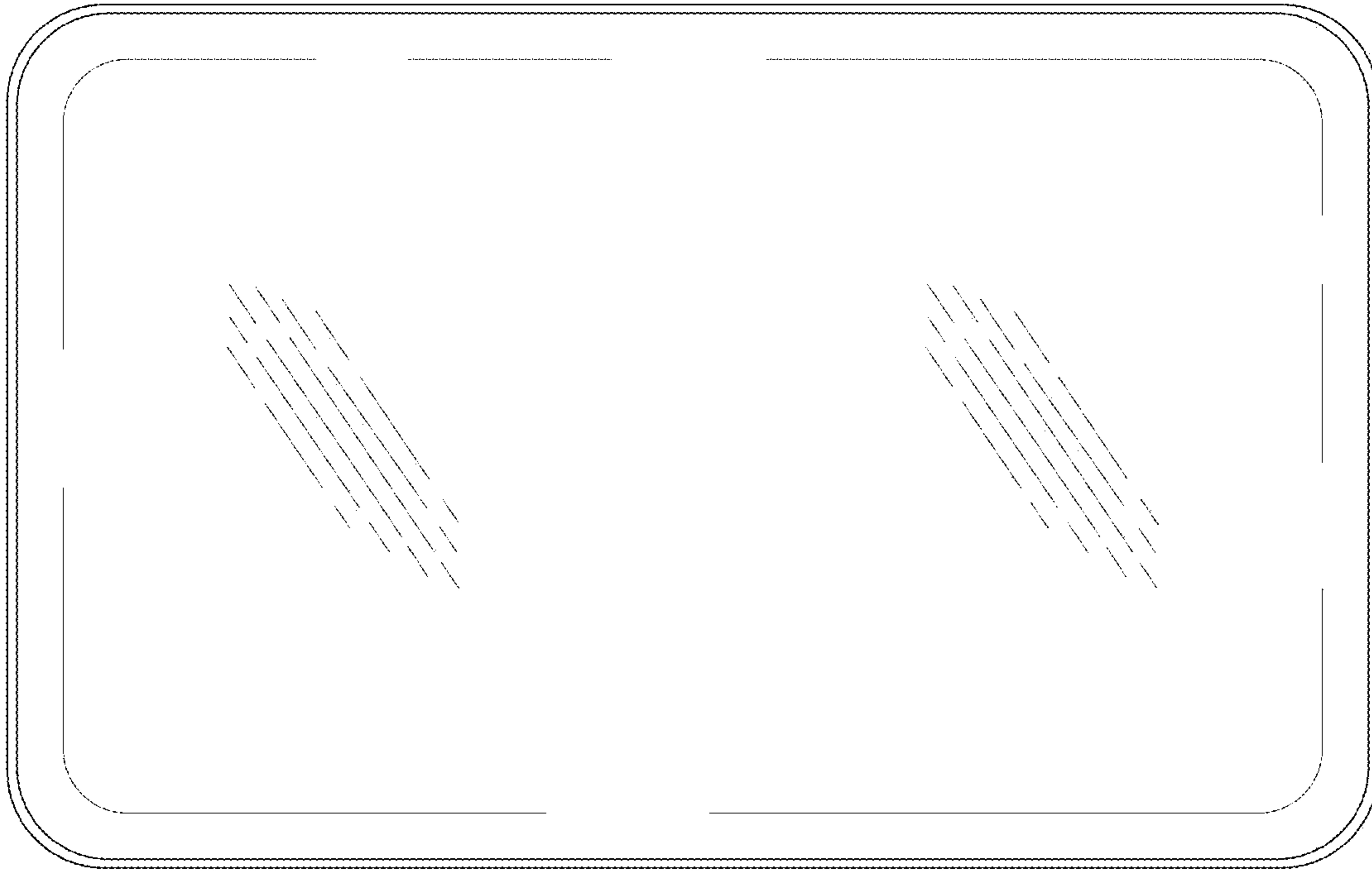

FIG.3

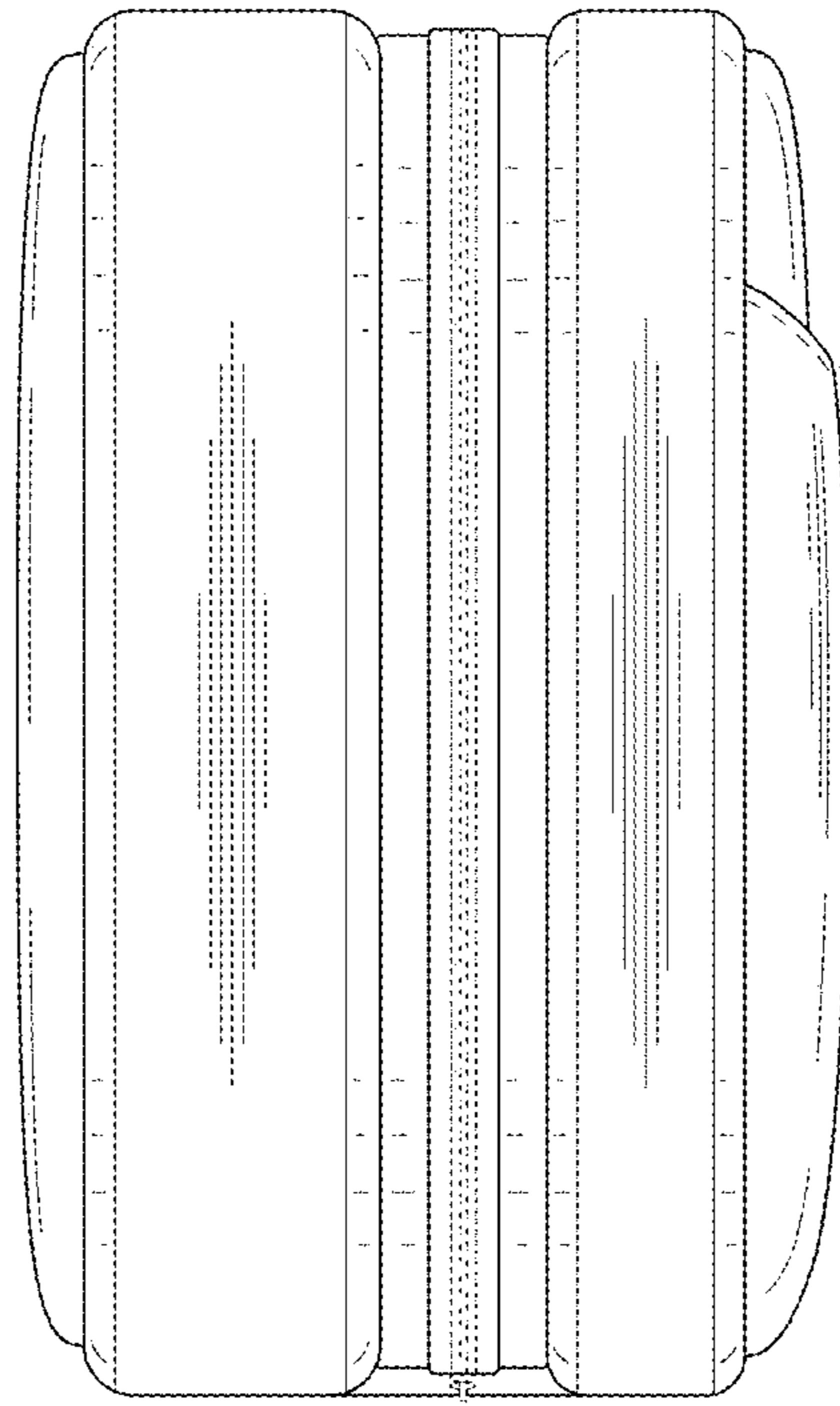

FIG.4

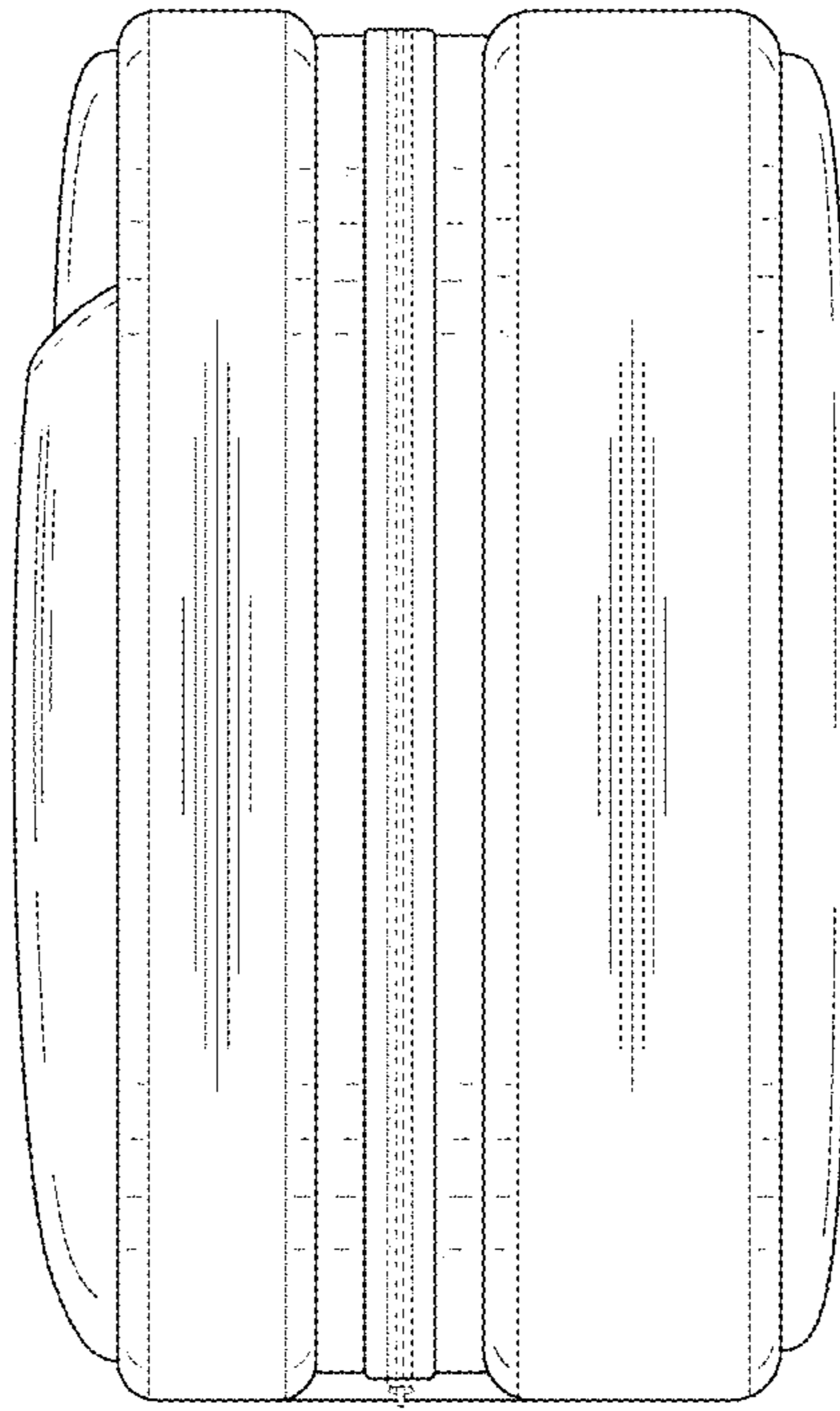

FIG.5

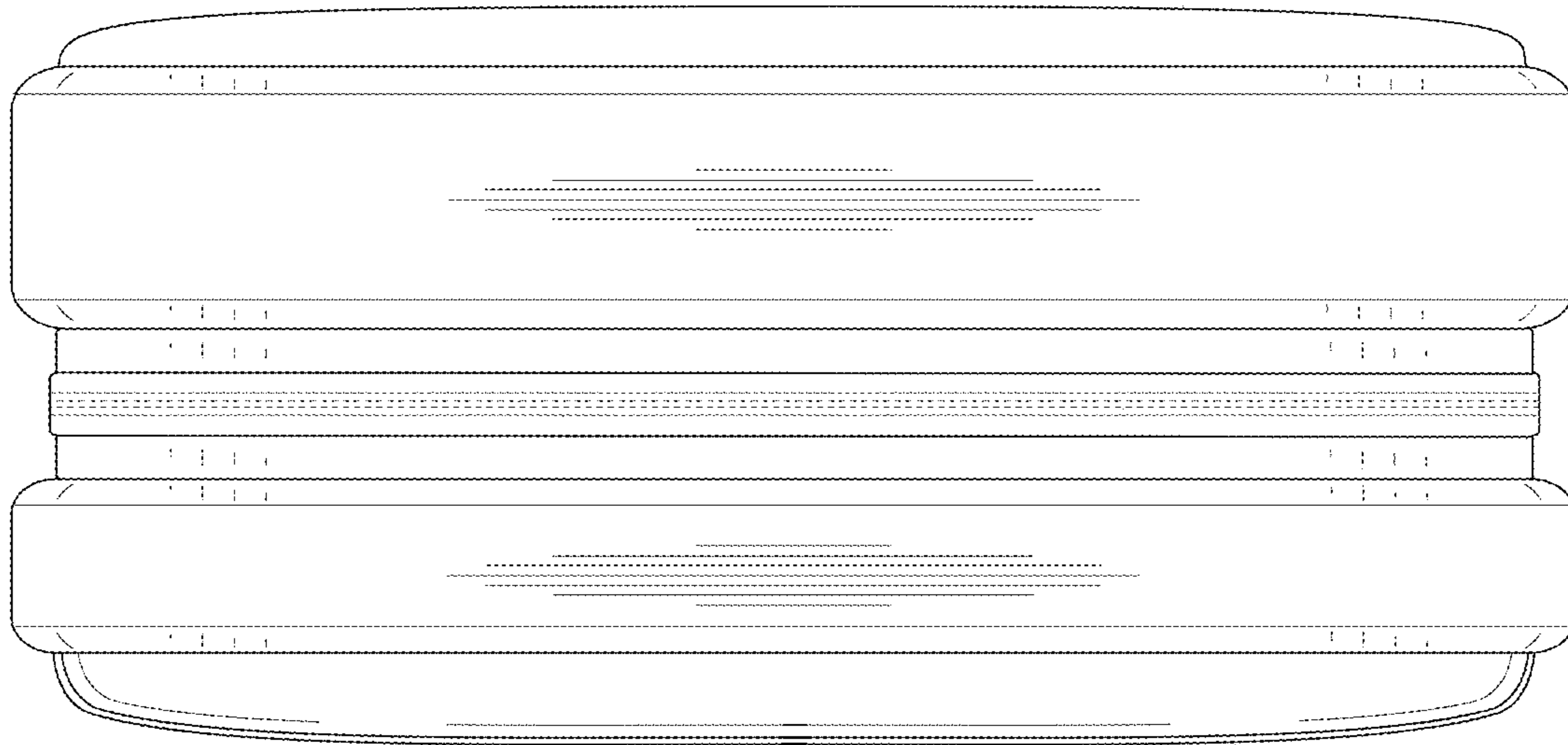

FIG.6

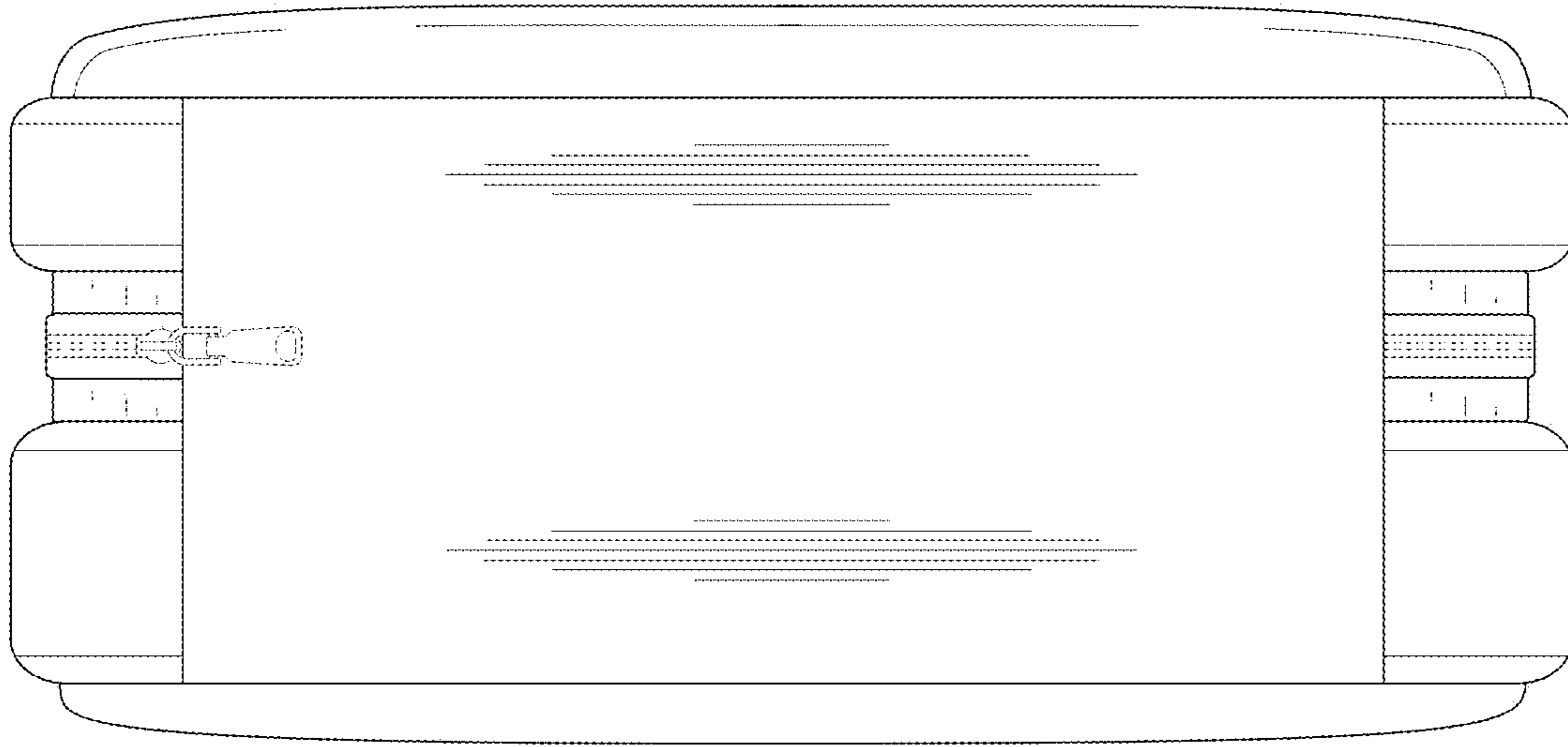

FIG.7

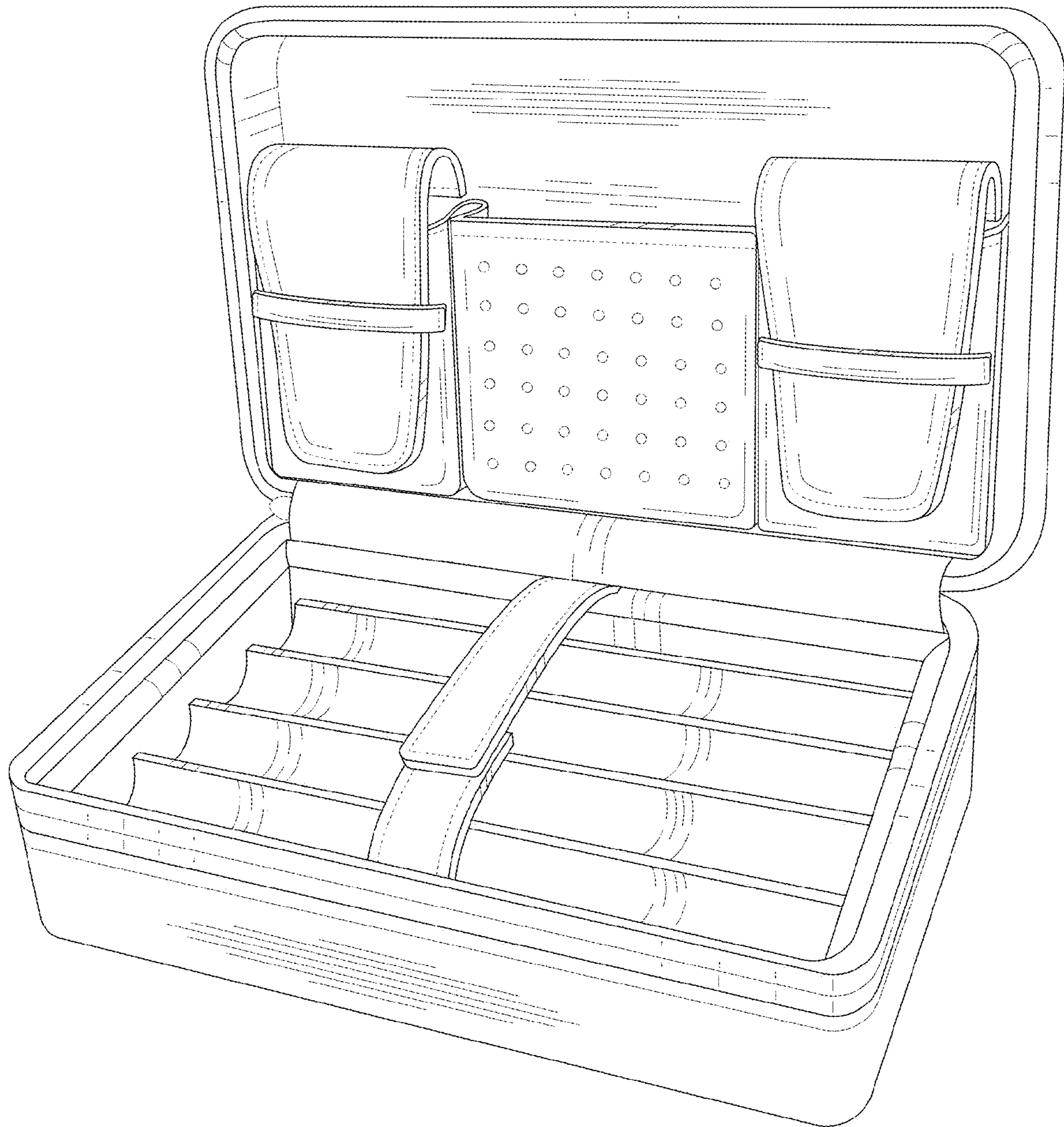

FIG.8



FIG.9