



US00D966545S

(12) **United States Design Patent**
Lin

(10) **Patent No.:** **US D966,545 S**

(45) **Date of Patent:** **** Oct. 11, 2022**

(54) **MASSAGER**

D952,887 S * 5/2022 Cai D24/215
D952,890 S * 5/2022 Cai D24/215
D952,891 S * 5/2022 Cai D24/215

(71) Applicant: **Chang Lin**, Lufeng (CN)

(72) Inventor: **Chang Lin**, Lufeng (CN)

(**) Term: **15 Years**

(21) Appl. No.: **29/809,156**

(22) Filed: **Sep. 26, 2021**

(51) **LOC (13) Cl.** **28-03**

(52) **U.S. Cl.**
USPC **D24/215**

(58) **Field of Classification Search**
USPC D24/141, 190, 200, 211, 212, 213, 214,
D24/215; D30/160

CPC A61H 19/44; A61H 19/32; A61H 19/40;
A61H 19/34; A61H 19/50; A61H
2205/087

See application file for complete search history.

(56) **References Cited**

U.S. PATENT DOCUMENTS

D712,059 S	8/2014	Sedic	
D771,828 S	11/2016	Sedic	
D879,990 S *	3/2020	Qiu	D24/215
D879,992 S *	3/2020	Li	D24/215
D882,109 S *	4/2020	Qiu	D24/215
D884,914 S *	5/2020	Gao	D24/215
D920,530 S *	5/2021	Sedic	D24/215
D945,006 S *	3/2022	Cai	D24/215
D949,414 S *	4/2022	Liu	D24/215
D949,428 S *	4/2022	Sedic	D24/215
D952,177 S *	5/2022	Jiang	D24/215

OTHER PUBLICATIONS

Amazon, "Lovehoney Vibrator", Date First Available Jan. 26, 2022.
<https://www.amazon.com/Lovehoney-Indulge-Clitoral-Sucking-Toy/dp/B09R7TW2WV?th=1>. Shown on p. 1. (Year: 2022).*

* cited by examiner

Primary Examiner — Michael A Maharajh

(57) **CLAIM**

The ornamental design for a massager, as shown and described.

DESCRIPTION

FIG. 1 is a perspective view of a massager showing my new design;

FIG. 2 is another perspective view thereof;

FIG. 3 is a front elevational view thereof;

FIG. 4 is a rear elevational view thereof;

FIG. 5 is a left side elevational view thereof;

FIG. 6 is a right side elevational view thereof;

FIG. 7 is a top plan view thereof; and,

FIG. 8 is a bottom plan view thereof.

The broken lines in the drawings depict portions of the massager that form no part of the claimed design.

1 Claim, 8 Drawing Sheets

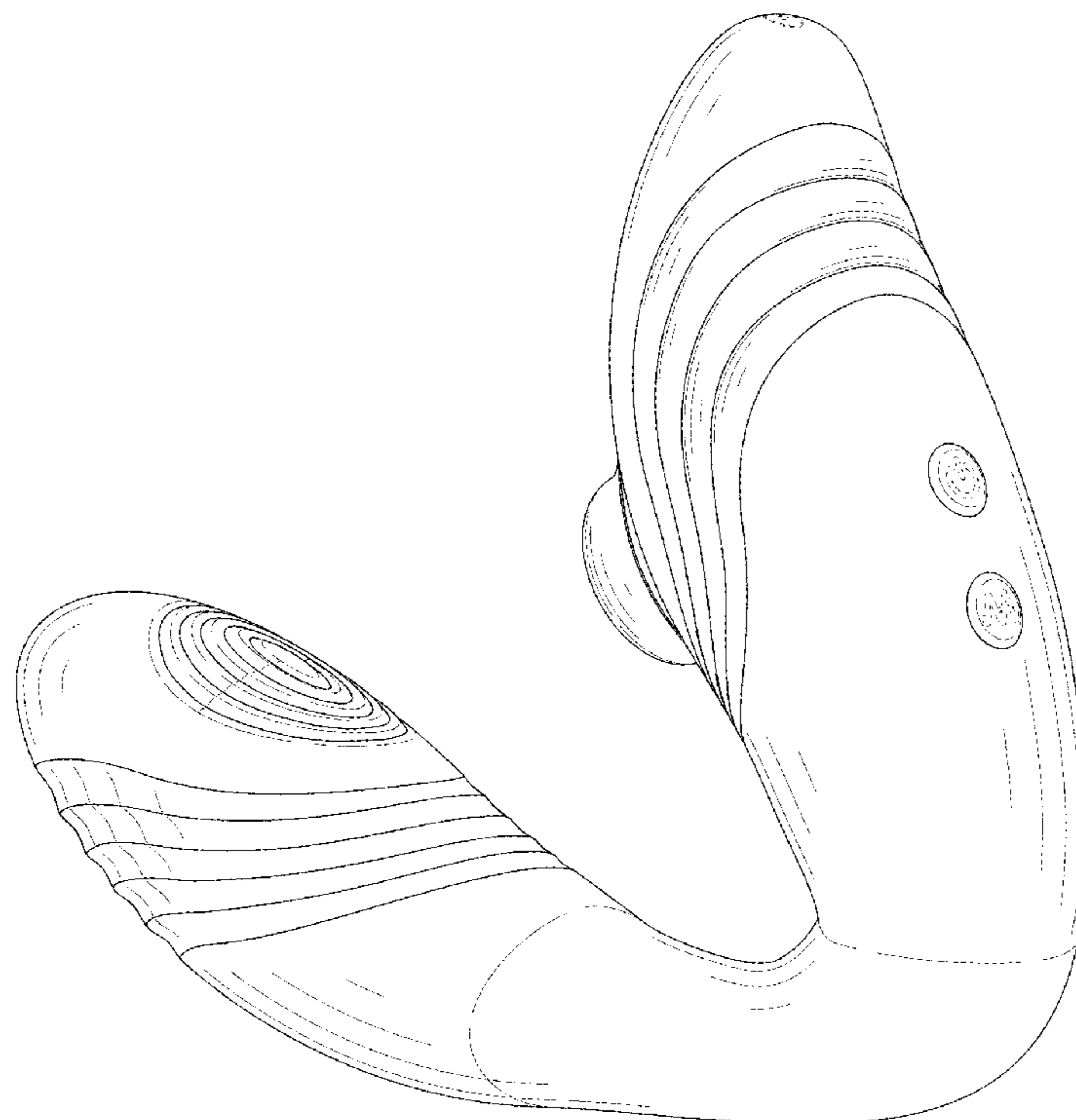

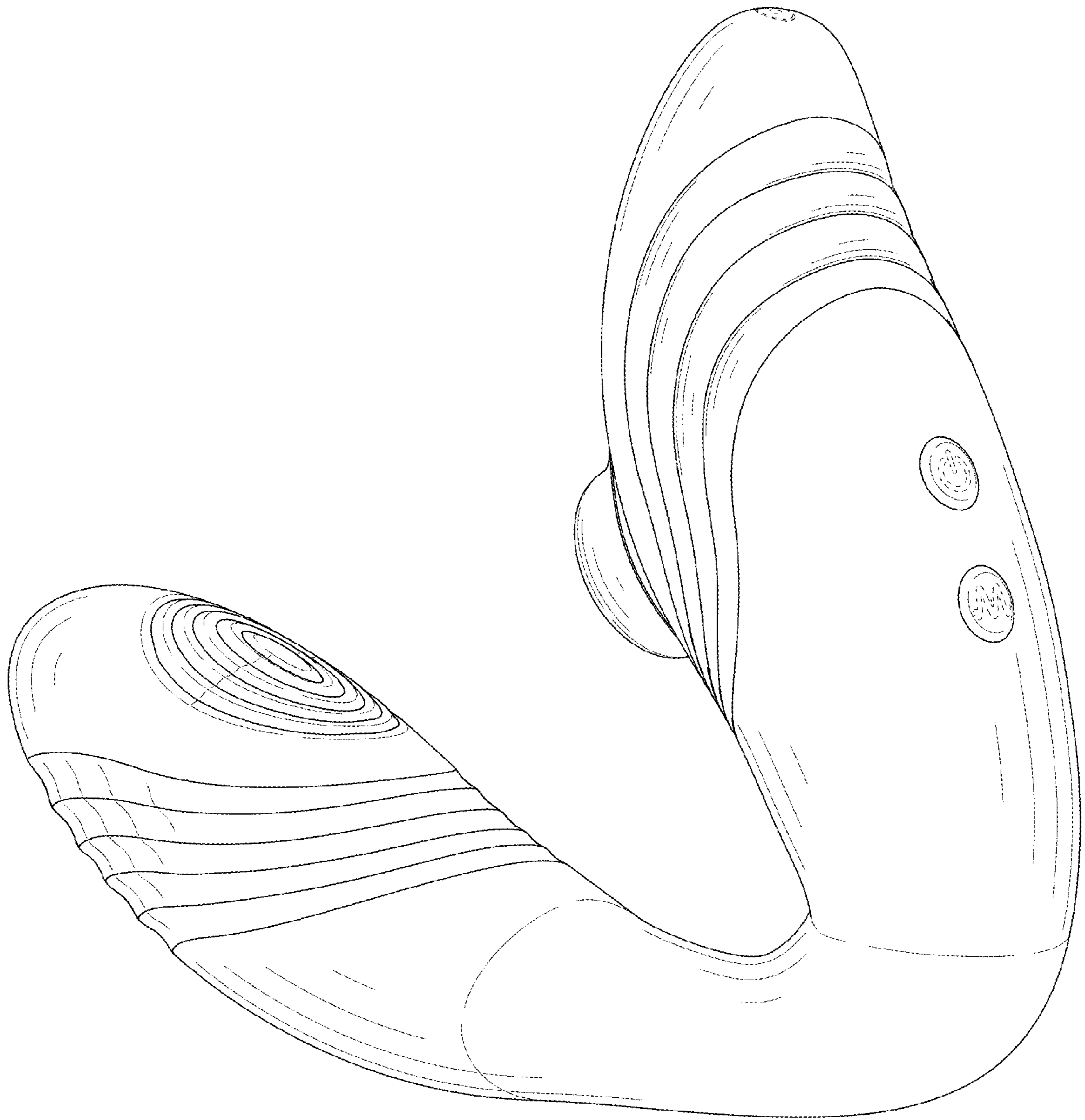

FIG. 1

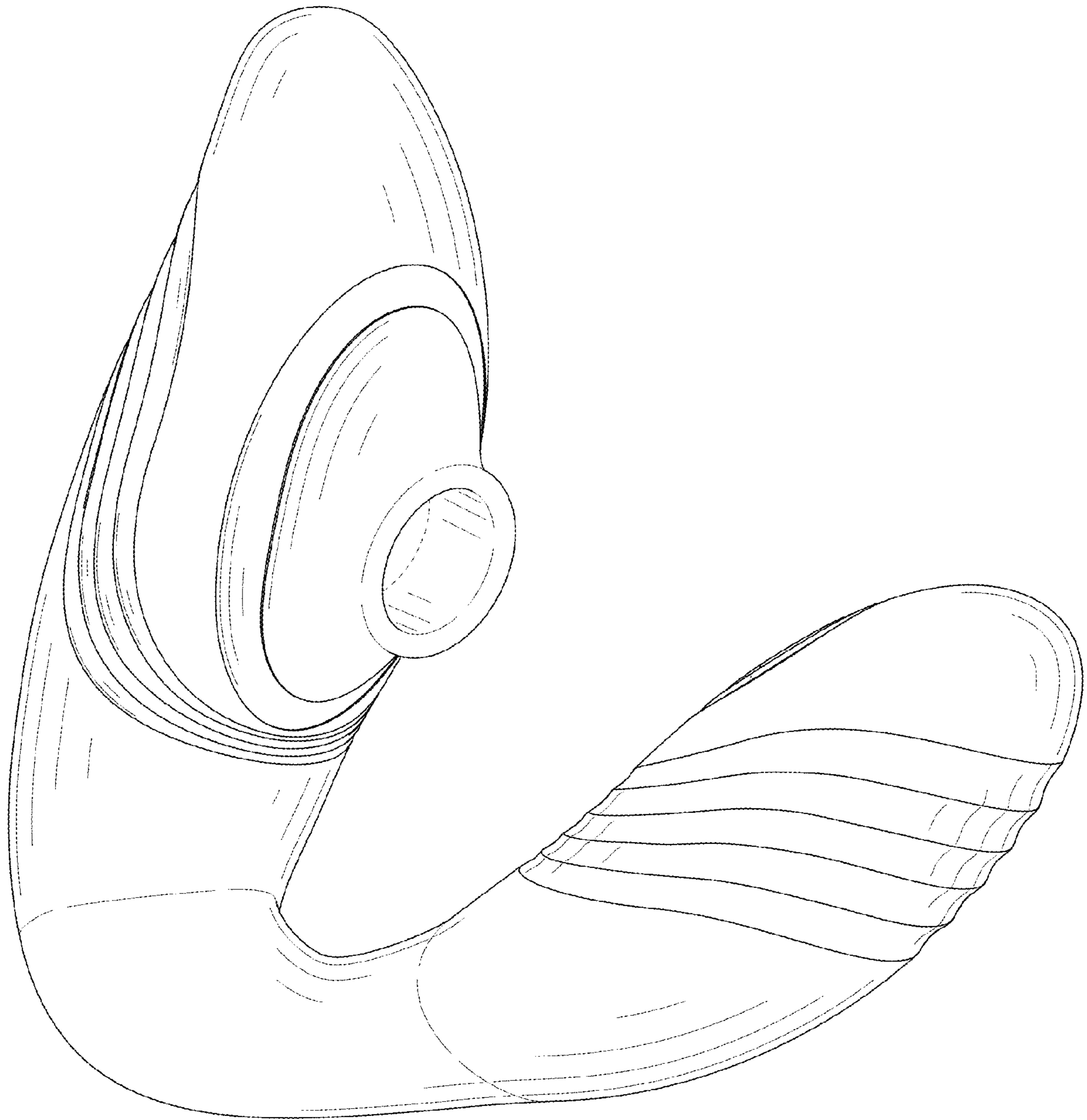

FIG. 2

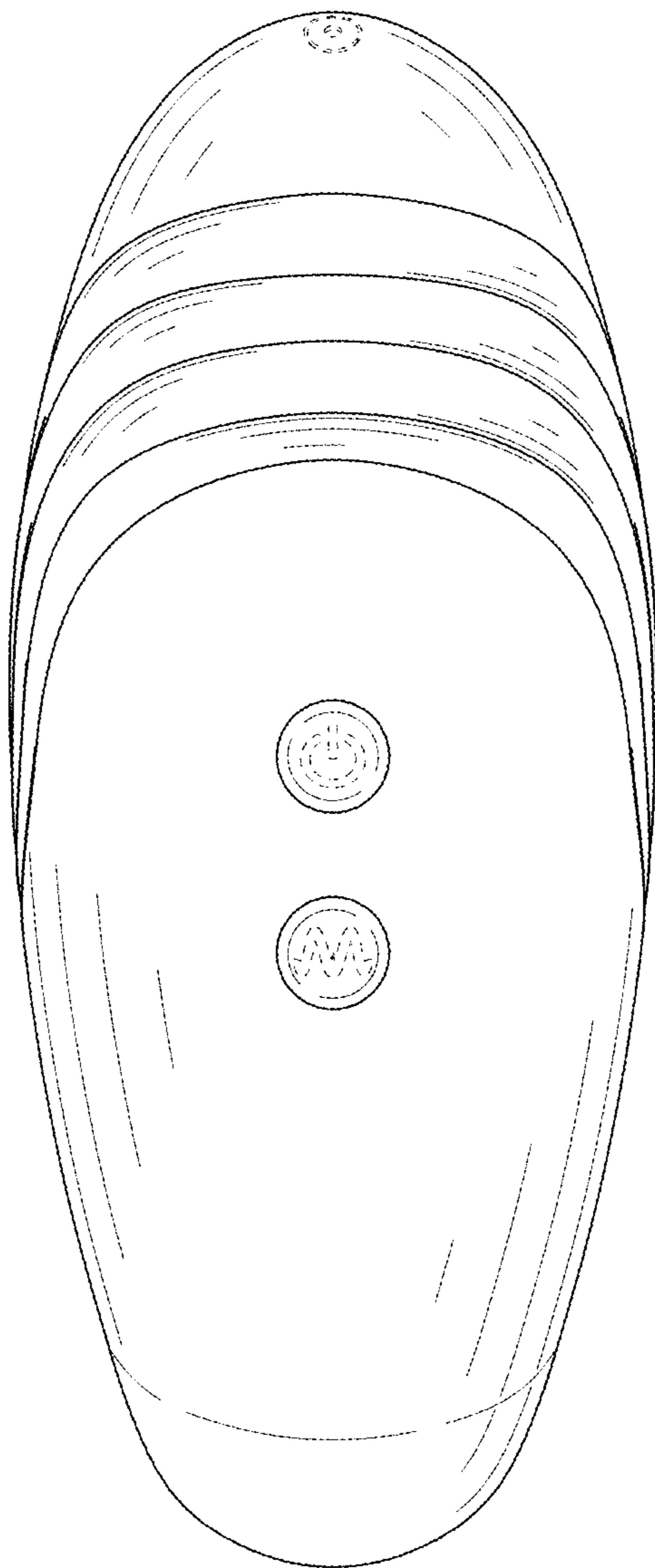

FIG. 3

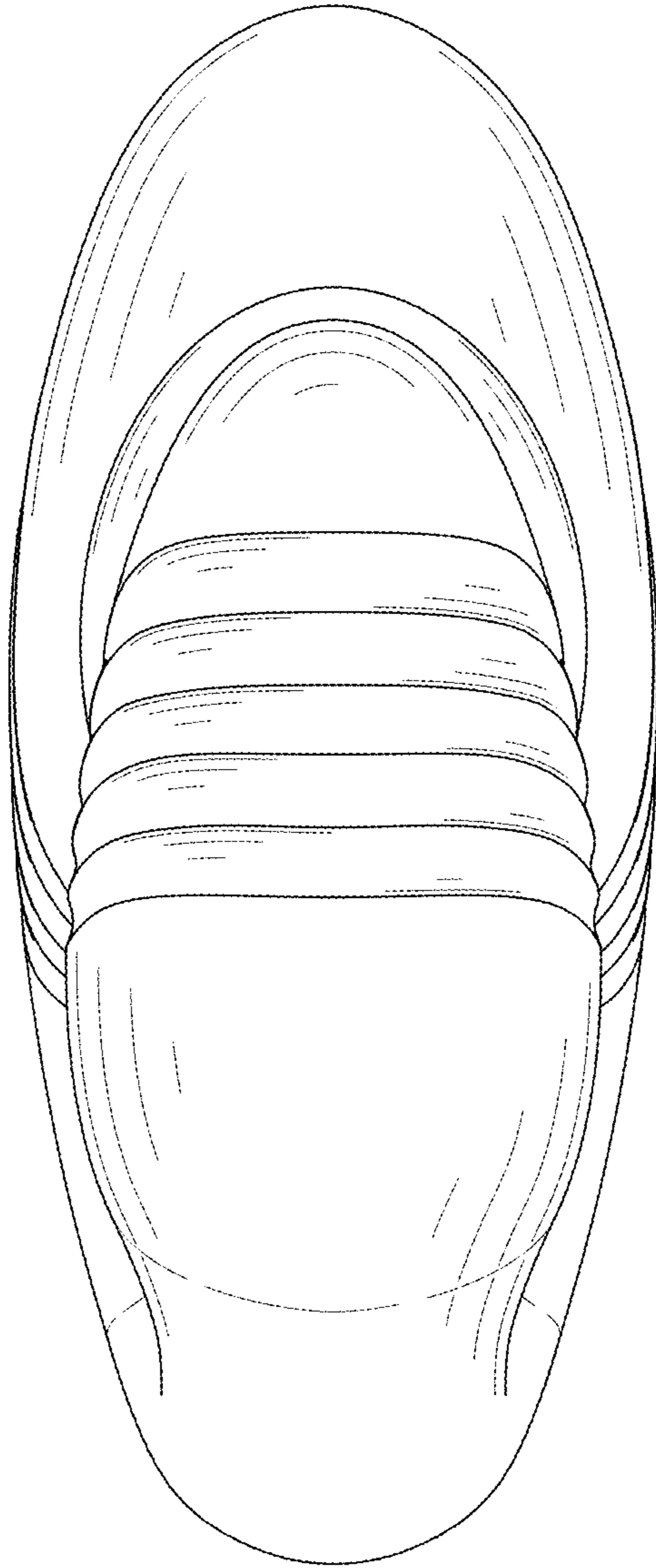

FIG. 4

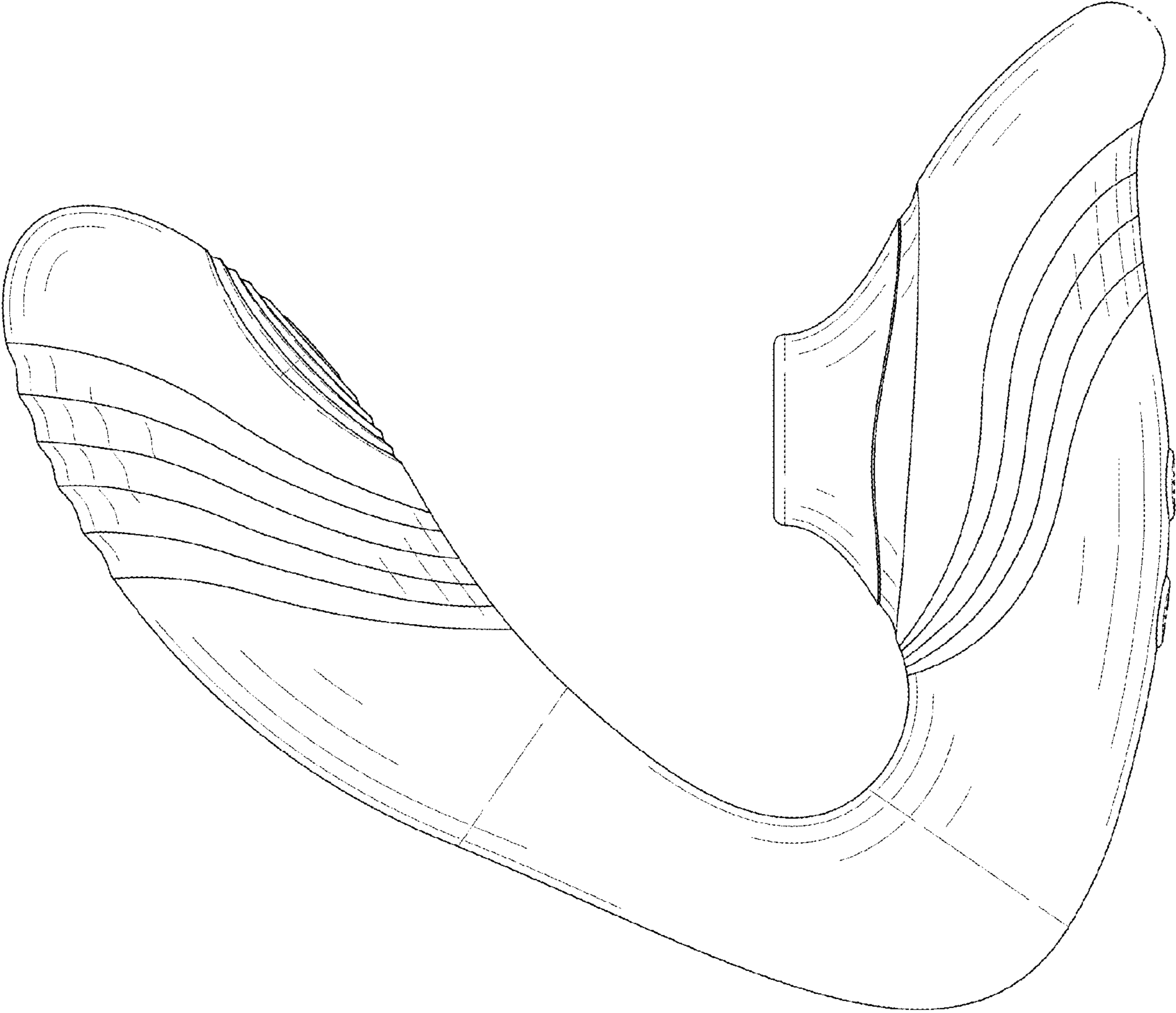

FIG. 5

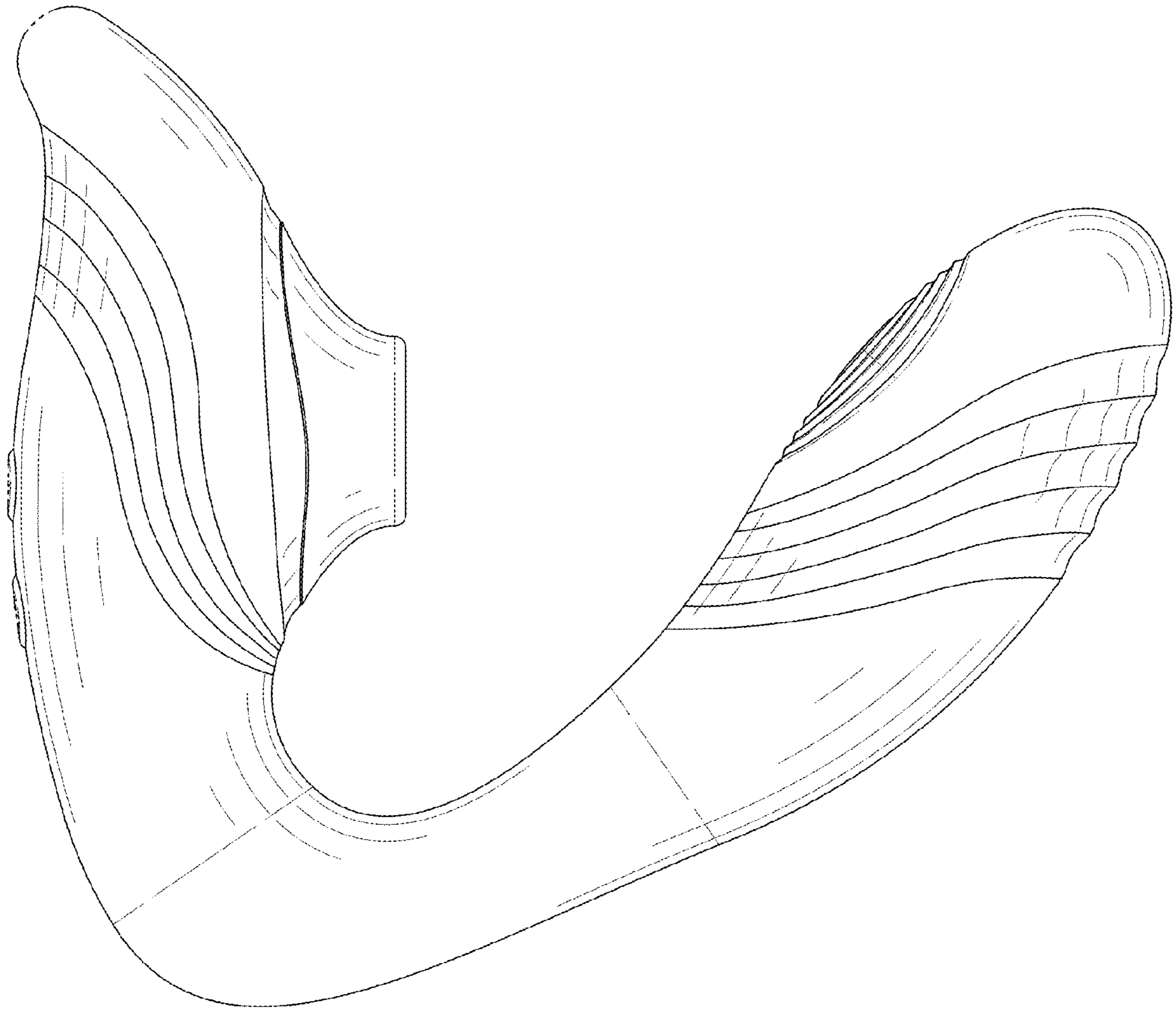

FIG. 6

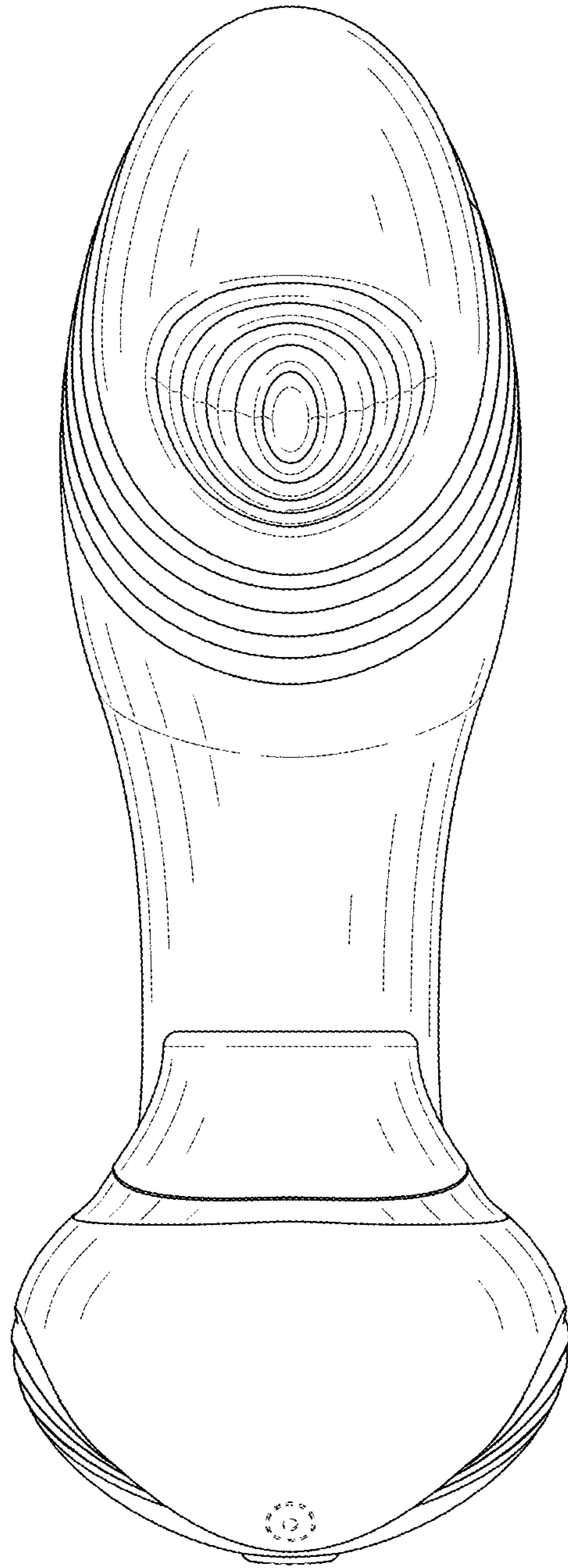

FIG. 7

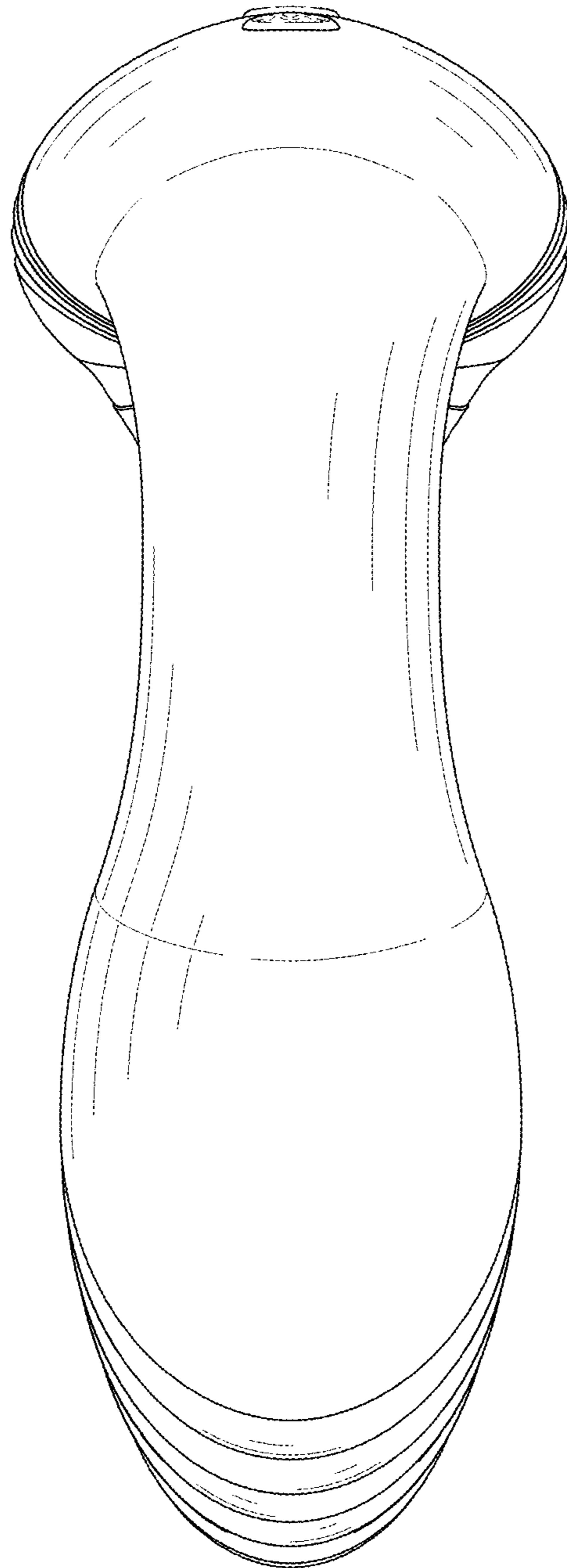

FIG. 8