



US00D966449S

(12) **United States Design Patent**  
**Bruschi et al.**

(10) **Patent No.:** **US D966,449 S**

(45) **Date of Patent:** **\*\* Oct. 11, 2022**

(54) **GOLF PUTTER**

(71) Applicant: **Taylor Made Golf Company, Inc.**,  
Carlsbad, CA (US)

(72) Inventors: **Giancarlo Bruschi**, San Diego, CA  
(US); **Paul M. Demkowski**, Carlsbad,  
CA (US); **Gustavo Eduardo Alisio**,  
San Diego, CA (US); **Bill Price**, Santa  
Ana, CA (US); **Robert Nunez**, Vista,  
CA (US)

(73) Assignee: **Taylor Made Golf Company, Inc.**,  
Carlsbad, CA (US)

(\*\*) Term: **15 Years**

(21) Appl. No.: **29/750,805**

(22) Filed: **Sep. 16, 2020**

(51) **LOC (13) Cl.** ..... **21-02**

(52) **U.S. Cl.**  
USPC ..... **D21/736**

(58) **Field of Classification Search**  
USPC ..... D21/736-746, 759  
CPC ..... A63B 53/00; A63B 53/04; A63B 53/007;  
A63B 53/065; A63B 53/0487; A63B  
60/00; A63B 60/46  
See application file for complete search history.

(56) **References Cited**

**U.S. PATENT DOCUMENTS**

D244,303 S *	5/1977	Cabot	.....	D21/745
D354,104 S *	1/1995	Hardy	.....	D21/739
D502,233 S *	2/2005	Grace	.....	D21/759
D502,234 S *	2/2005	Grace	.....	D21/759
D521,088 S *	5/2006	Mercier	.....	D21/736

7,204,765 B2 *	4/2007	Cover	.....	A63B 60/02 473/340
D550,795 S *	9/2007	Tateno	.....	D21/744
D560,736 S *	1/2008	Tateno	.....	D21/744
D676,510 S *	2/2013	Kargetta	.....	D21/736
D908,826 S *	1/2021	Clarke	.....	D21/736
D941,945 S *	1/2022	Nicolette	.....	D21/736

\* cited by examiner

*Primary Examiner* — Mitchell I. Siegel

(74) *Attorney, Agent, or Firm* — Klarquist Sparkman,  
LLP

(57) **CLAIM**

We claim the ornamental design for a golf putter, as shown  
and described.

**DESCRIPTION**

FIG. 1 is a top, heel side and rear perspective view of a golf  
putter.

FIG. 2 is a front elevation view of the golf putter of FIG. 1.

FIG. 3 is a rear elevation view of the golf putter of FIG. 1.

FIG. 4 is a side elevation view of a toe side of the golf putter  
of FIG. 1.

FIG. 5 is a side elevation view of a heel side of the golf  
putter of FIG. 1.

FIG. 6 is a top plan view of the golf putter of FIG. 1.

FIG. 7 is a bottom plan view of the golf putter of FIG. 1; and,

FIG. 8 is a bottom, heel side and rear perspective view of the  
golf putter of FIG. 1.

The broken lines in the drawings are for purpose of illus-  
trating environmental structure as well as portions of the  
design that form no part of the present claimed design. The  
dash-dot broken lines represent the boundary and form no  
part of the claimed design.

**1 Claim, 6 Drawing Sheets**

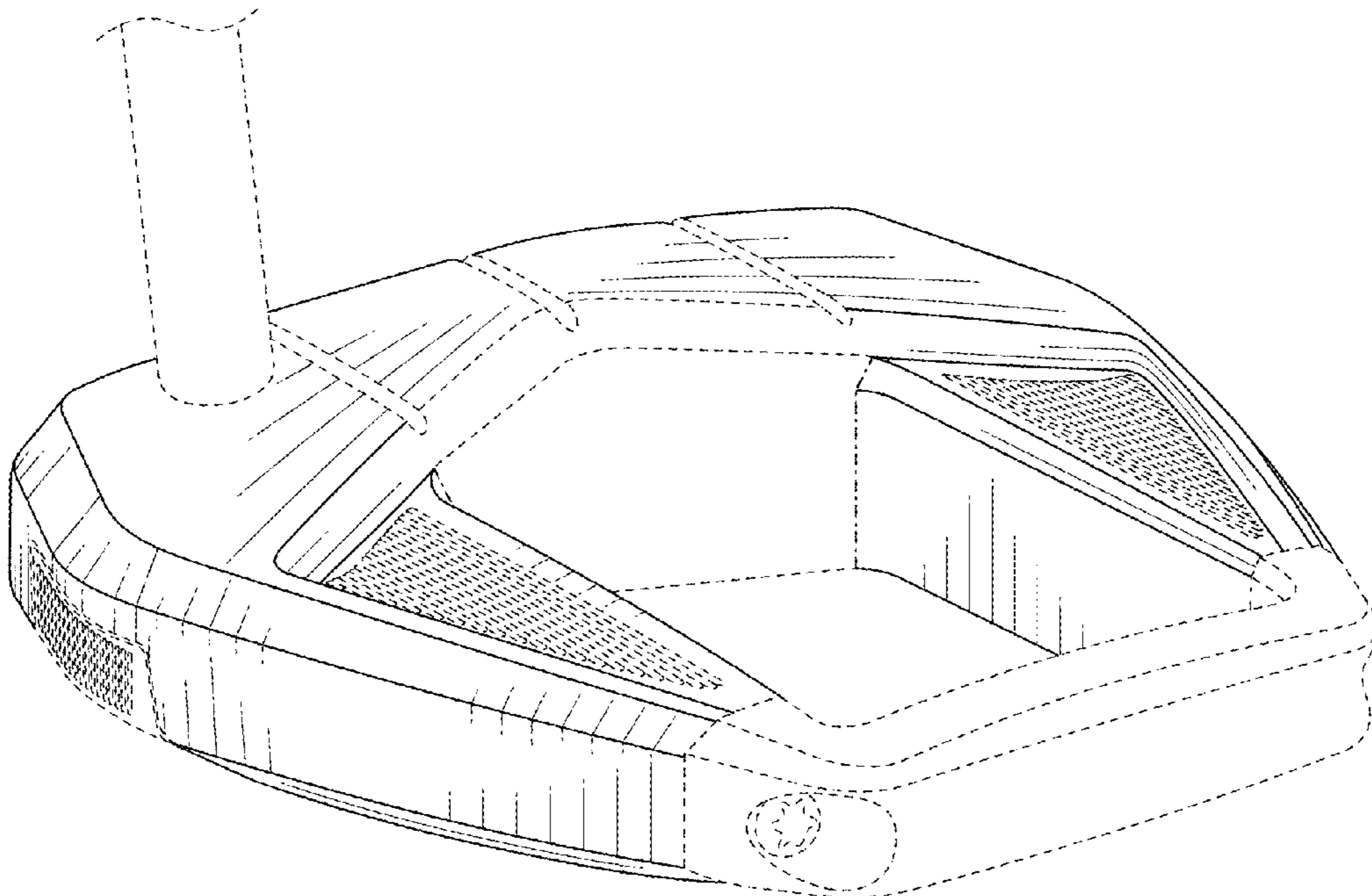

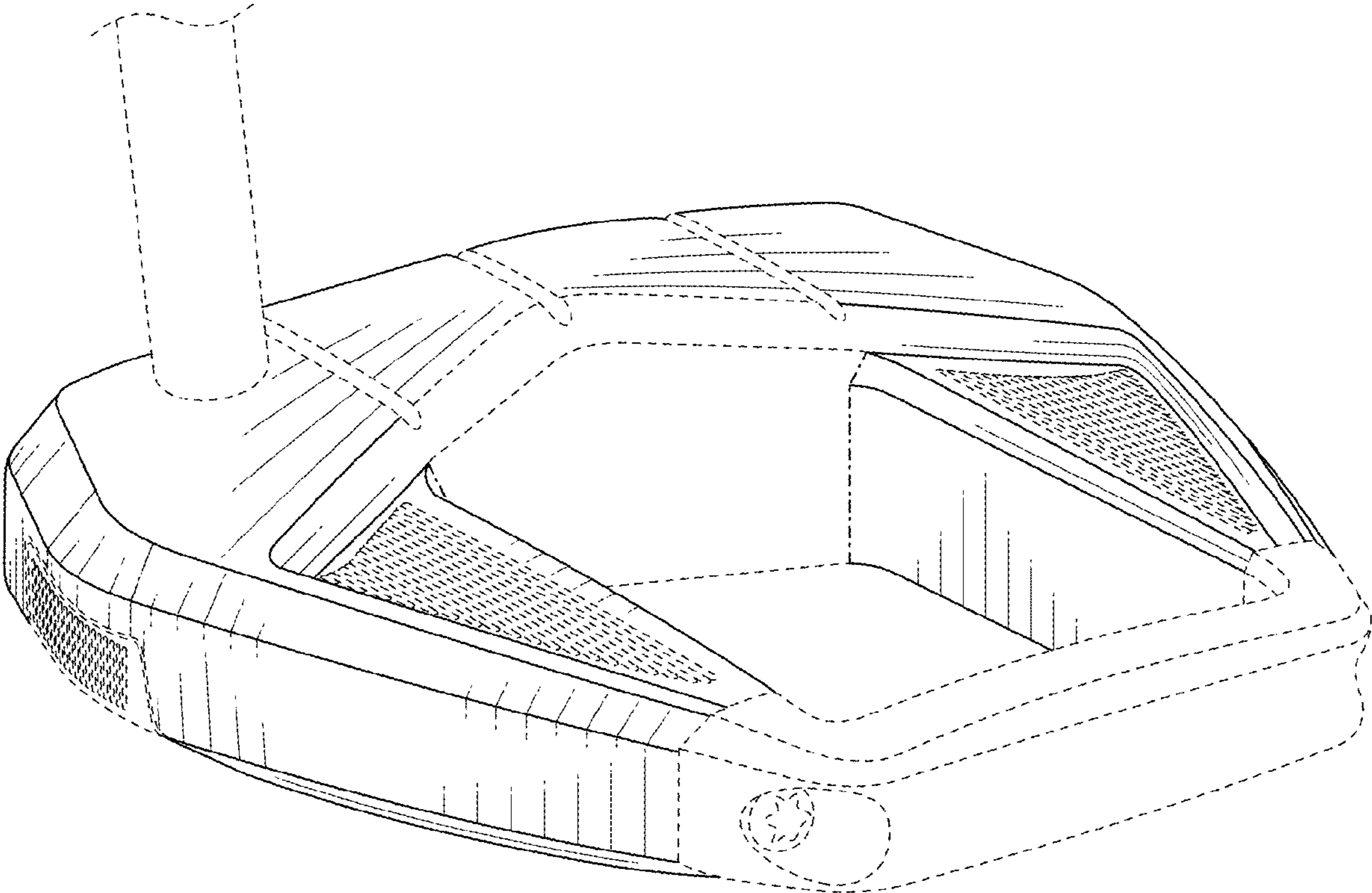

FIG. 1

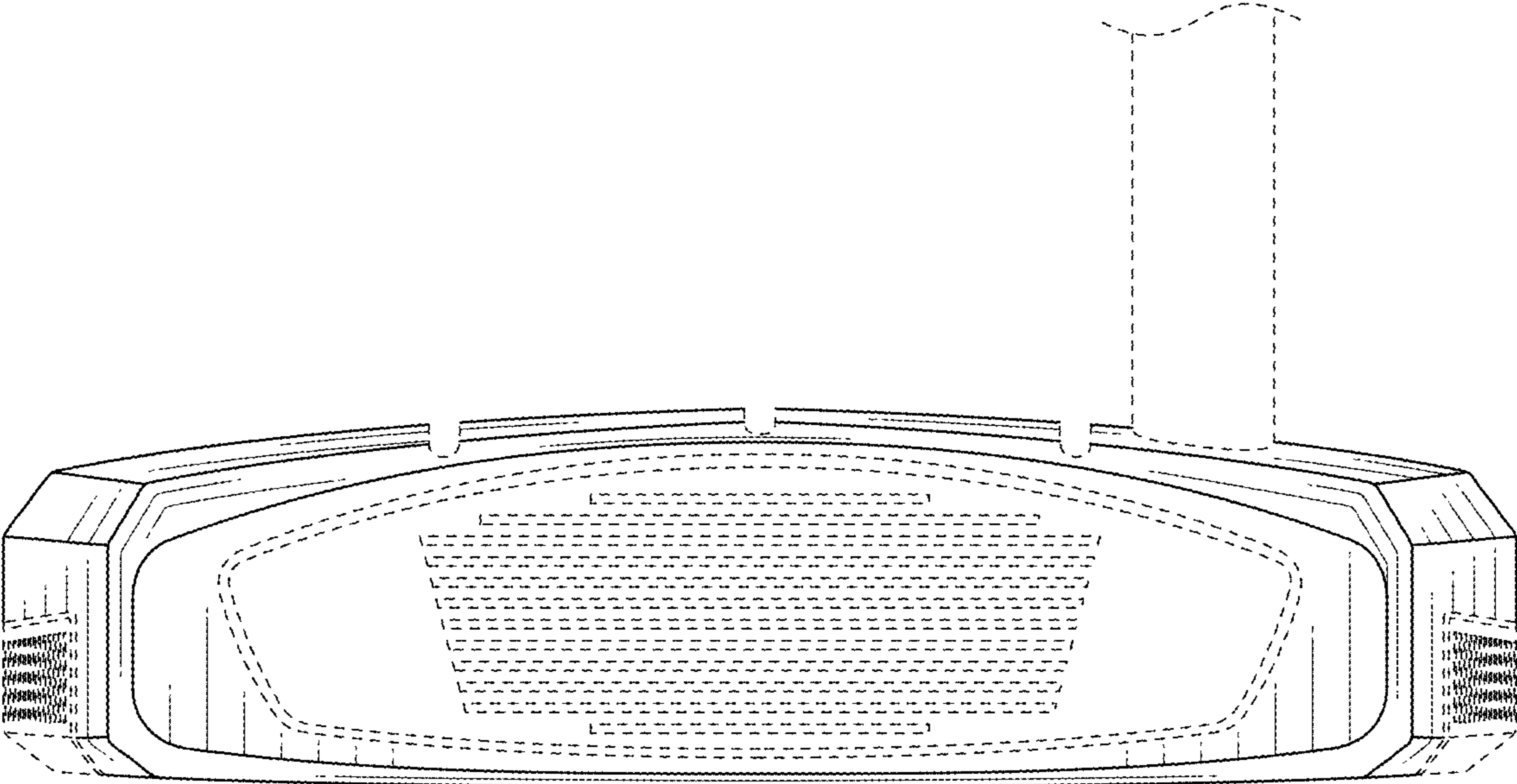

FIG. 2

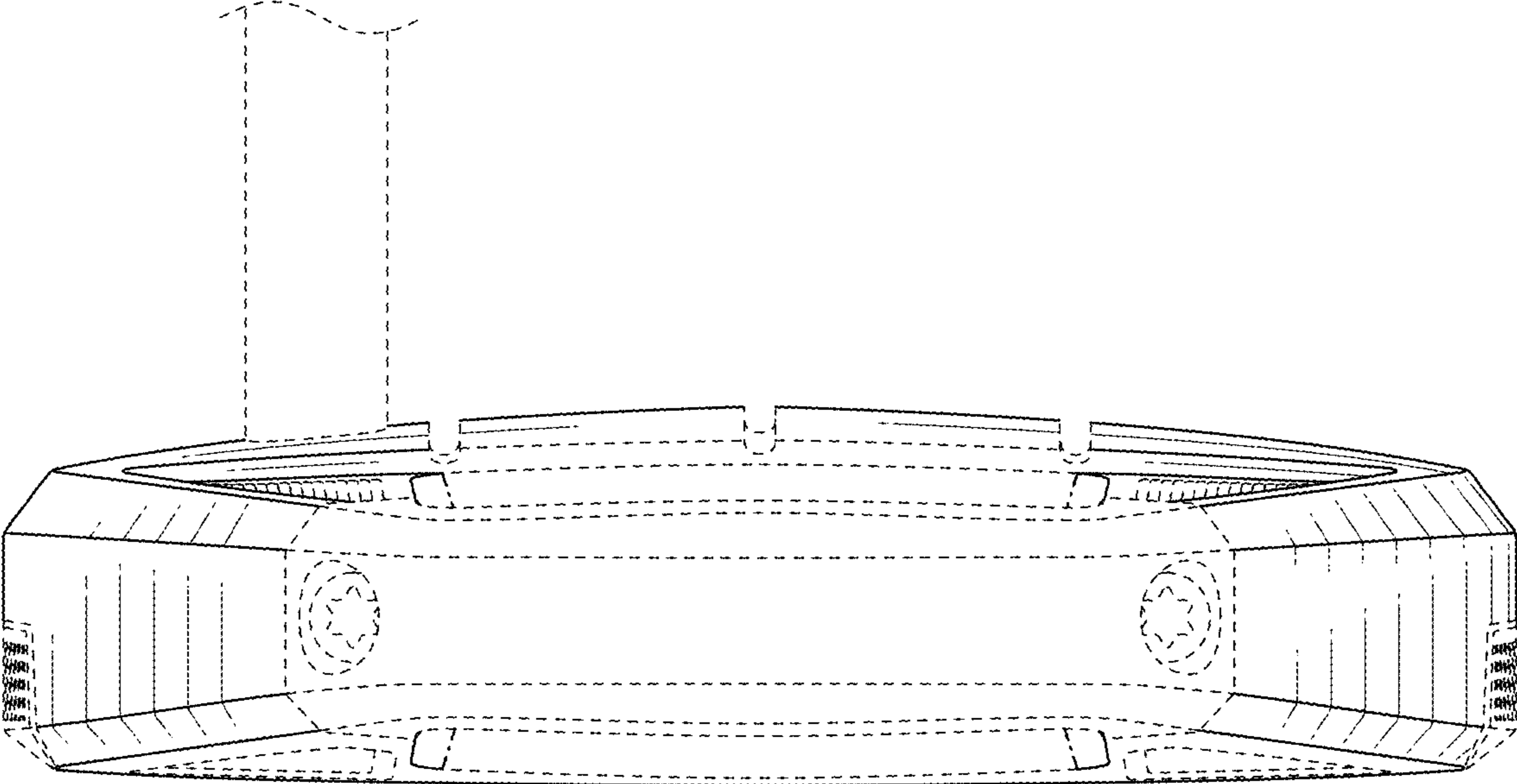

FIG. 3

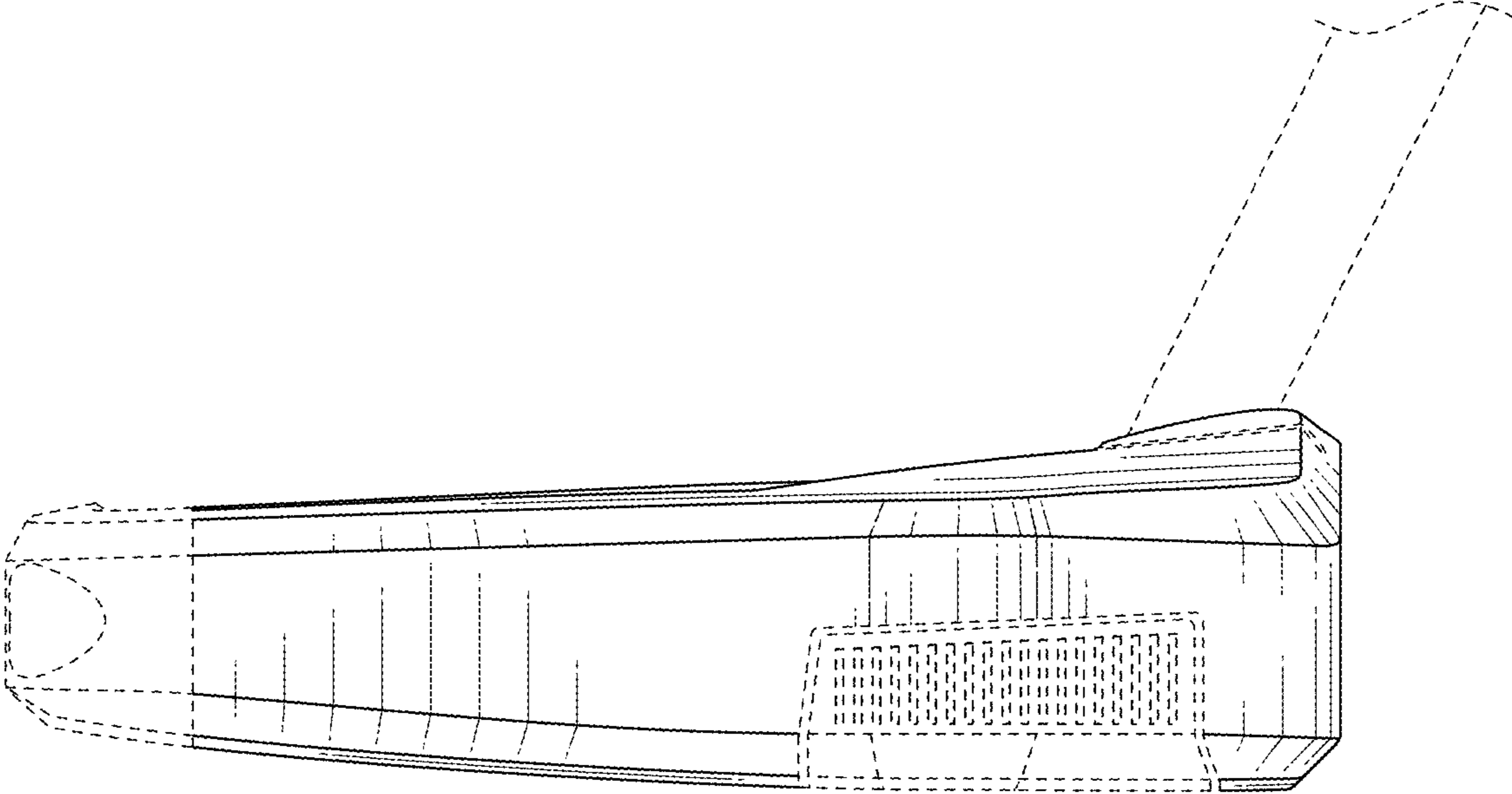

FIG. 4

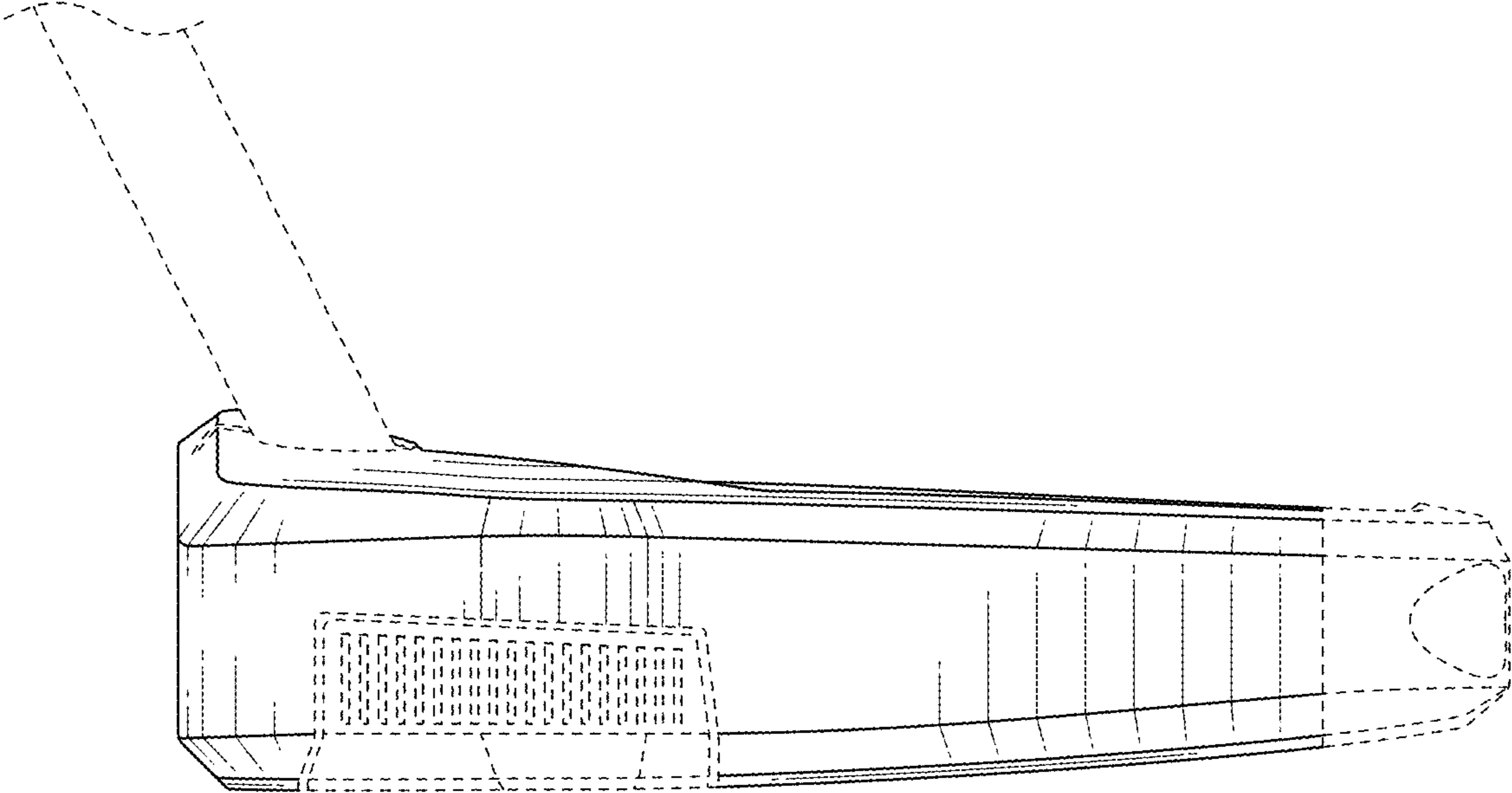

FIG. 5

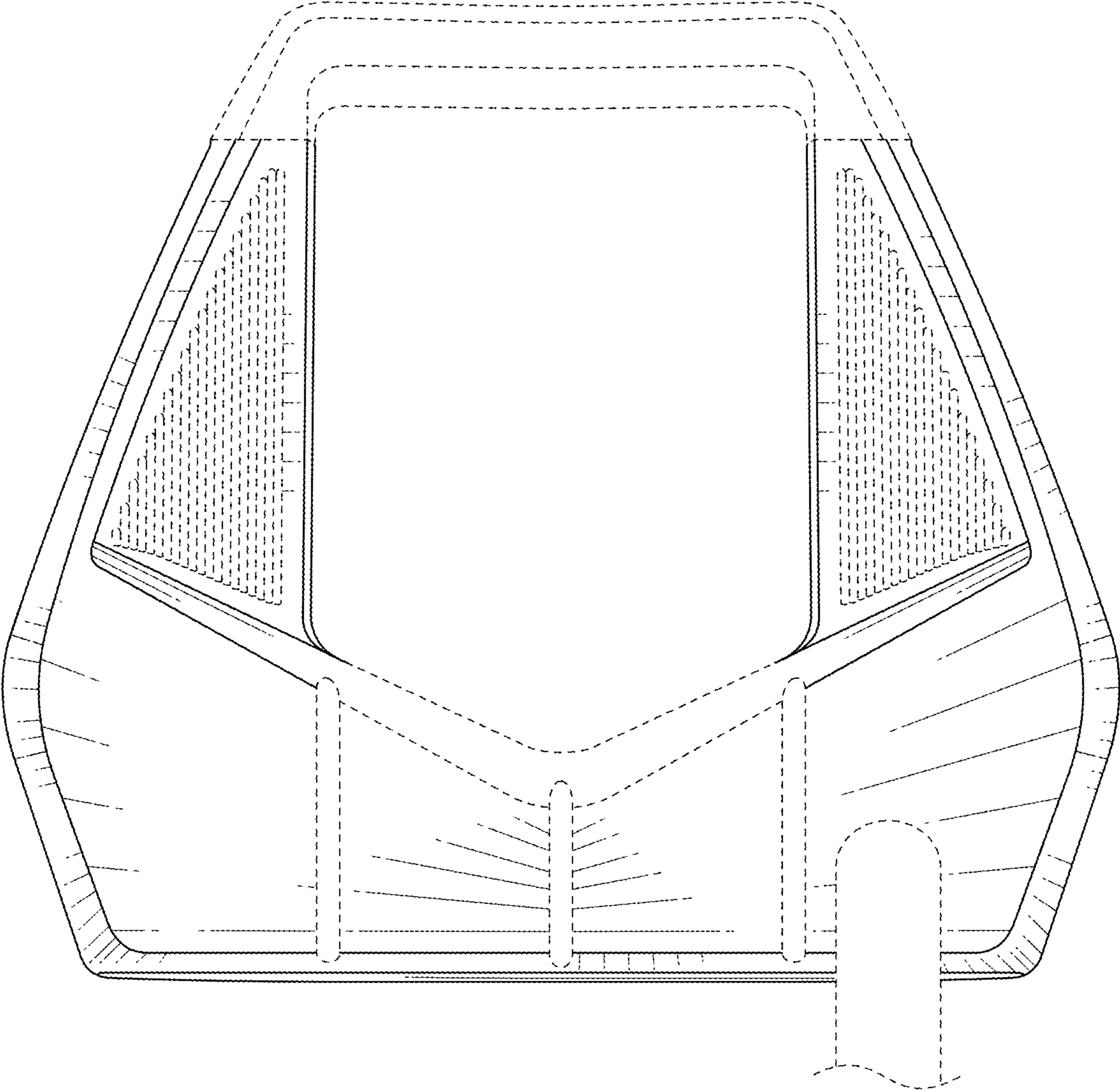

FIG. 6

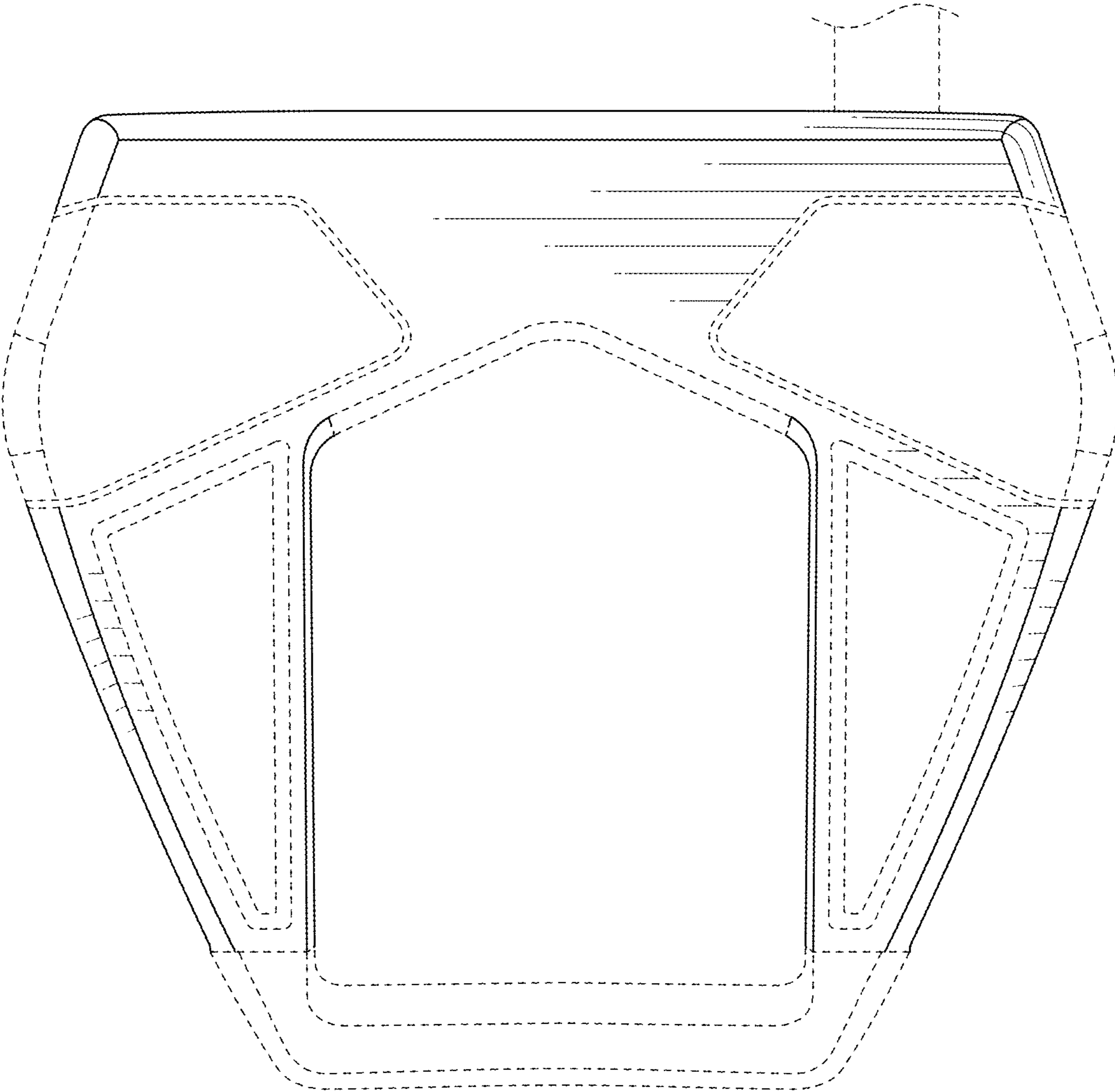

FIG. 7

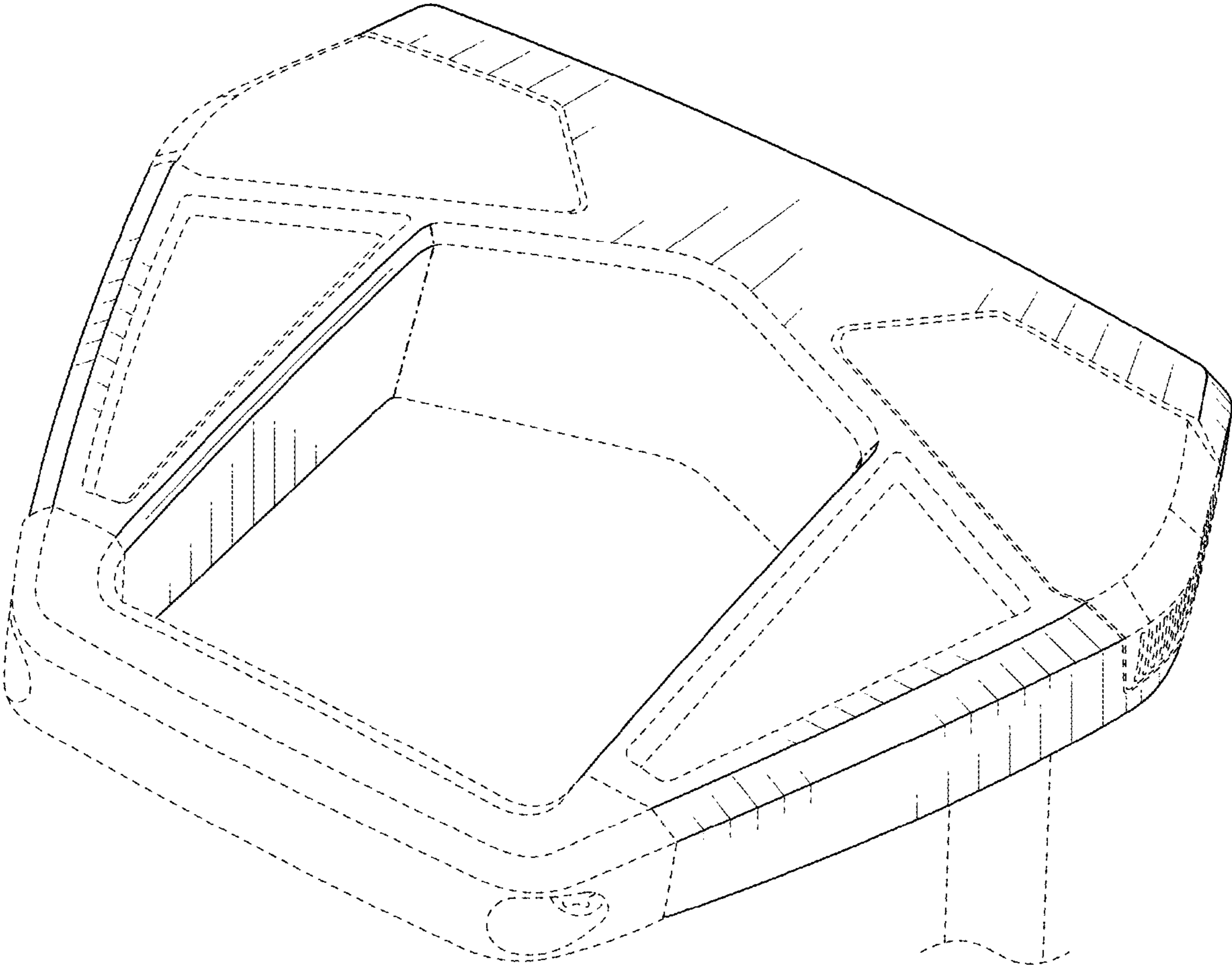

FIG. 8