

US00D966419S

(12) **United States Design Patent**  
**Wei**

(10) **Patent No.:** **US D966,419 S**

(45) **Date of Patent:** **\*\* Oct. 11, 2022**

(54) **MUSHROOM THUMB GRIP CAP**  
(71) Applicant: **Nanning Youdide Electronic Commerce Co., Ltd., Nanning (CN)**

(72) Inventor: **Huixuan Wei, Nanning (CN)**

(73) Assignee: **Nanning Youdide Electronic Commerce Co., Ltd., Nanning (CN)**

(\*\*) Term: **15 Years**

(21) Appl. No.: **29/840,471**

(22) Filed: **May 30, 2022**

(51) **LOC (13) Cl.** ..... **21-01**

(52) **U.S. Cl.**  
USPC ..... **D21/333; D14/432**

(58) **Field of Classification Search**  
USPC ..... D7/312, 313, 316, 387, 393, 396.1, D7/396.2, 397, 398, 400, 388, 391; D9/434-442, 446, 447, 451, 452, 453, D9/454; D23/206, 209, 238, 249, 255, D23/259, 260, 261, 265; D3/29; D8/300, 322; D14/401, 432; D21/333  
CPC ..... A47J 31/0673; B65D 85/8046; B65D 2251/0015; B65D 2251/0071; B65D 2251/20; B65D 47/2031; A61J 1/2096; A61J 1/2051; A61J 1/14  
See application file for complete search history.

(56) **References Cited**

**U.S. PATENT DOCUMENTS**

D229,737 S *	1/1974	Taylor	.....	D7/391
D291,536 S *	8/1987	Crawford	.....	D9/449
D317,411 S *	6/1991	Holmes	.....	D9/435
D411,409 S *	6/1999	Wallays	.....	D7/391
D461,813 S *	8/2002	Chang	.....	D13/174
D530,610 S *	10/2006	Samz	.....	D9/449
D550,557 S *	9/2007	Vogel	.....	D9/440
D657,671 S *	4/2012	O'Brien	.....	D9/454

D658,935 S *	5/2012	Luppino	.....	D7/392
D790,355 S *	6/2017	Bae	.....	D9/644
D825,345 S *	8/2018	Caly	.....	D9/426
D890,608 S	7/2020	Sordo et al.		

(Continued)

**OTHER PUBLICATIONS**

Ocanblu Thumb Grip: Announced (Apr. 3, 2022). Site Visited (Jul. 26, 2022). Available from Internet URL: [https://www.amazon.com/Ocanblu-Mushroom-Compatible-Nintendo-Silicone/dp/B09X4KR2F4/ref=sr\\_1\\_1?keywords=Ocanblu&qid=1658849916&sr=8-1](https://www.amazon.com/Ocanblu-Mushroom-Compatible-Nintendo-Silicone/dp/B09X4KR2F4/ref=sr_1_1?keywords=Ocanblu&qid=1658849916&sr=8-1).\*

*Primary Examiner* — Catherine S Posthauer

(57) **CLAIM**

The ornamental design for a mushroom thumb grip cap, as shown and described.

**DESCRIPTION**

FIG. 1 is a front perspective view of a first embodiment of a mushroom thumb grip cap, showing my new design; FIG. 2 is a rear perspective view thereof; FIG. 3 is a front view thereof; FIG. 4 is a rear view thereof; FIG. 5 is a right side view thereof; FIG. 6 is a left side view thereof; FIG. 7 is a bottom view thereof; FIG. 8 is a top view thereof; FIG. 9 is a cross sectional view taken in the direction of line 9-9 on FIG. 3; FIG. 10 is a front perspective view of a second embodiment of the mushroom thumb grip cap, showing my new design; FIG. 11 is a rear perspective view thereof; FIG. 12 is a front view thereof; FIG. 13 is a rear view thereof; FIG. 14 is a right side view thereof; FIG. 15 is a left side view thereof; FIG. 16 is a bottom view thereof; FIG. 17 is a top view thereof; and, FIG. 18 is a cross sectional view taken in the direction of line 18-18 on FIG. 12.

**1 Claim, 18 Drawing Sheets**

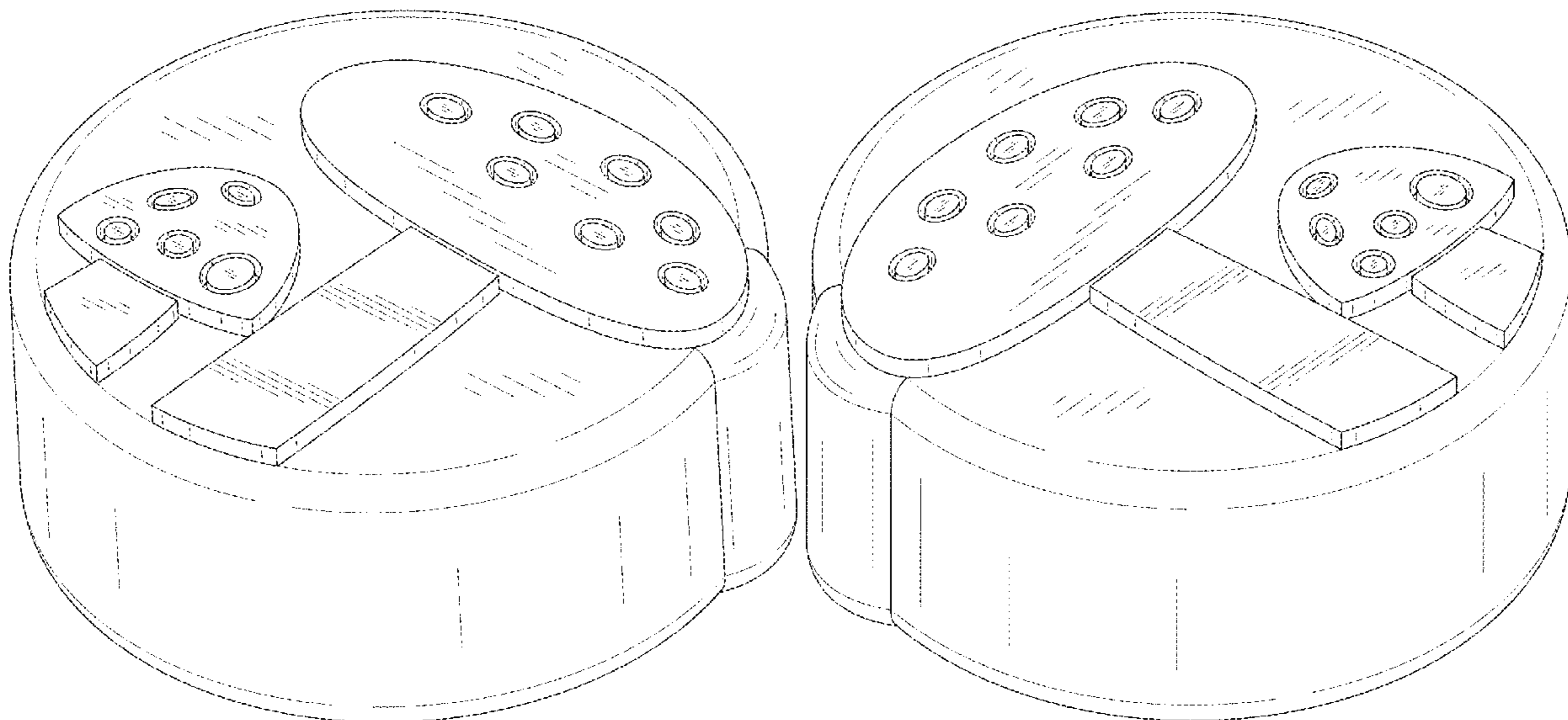

(56)

**References Cited**

U.S. PATENT DOCUMENTS

D943,349 S \* 2/2022 Mutch ..... D7/401.1  
D950,356 S \* 5/2022 Swartz ..... D8/305  
D957,229 S \* 7/2022 Swartz ..... D8/322

\* cited by examiner

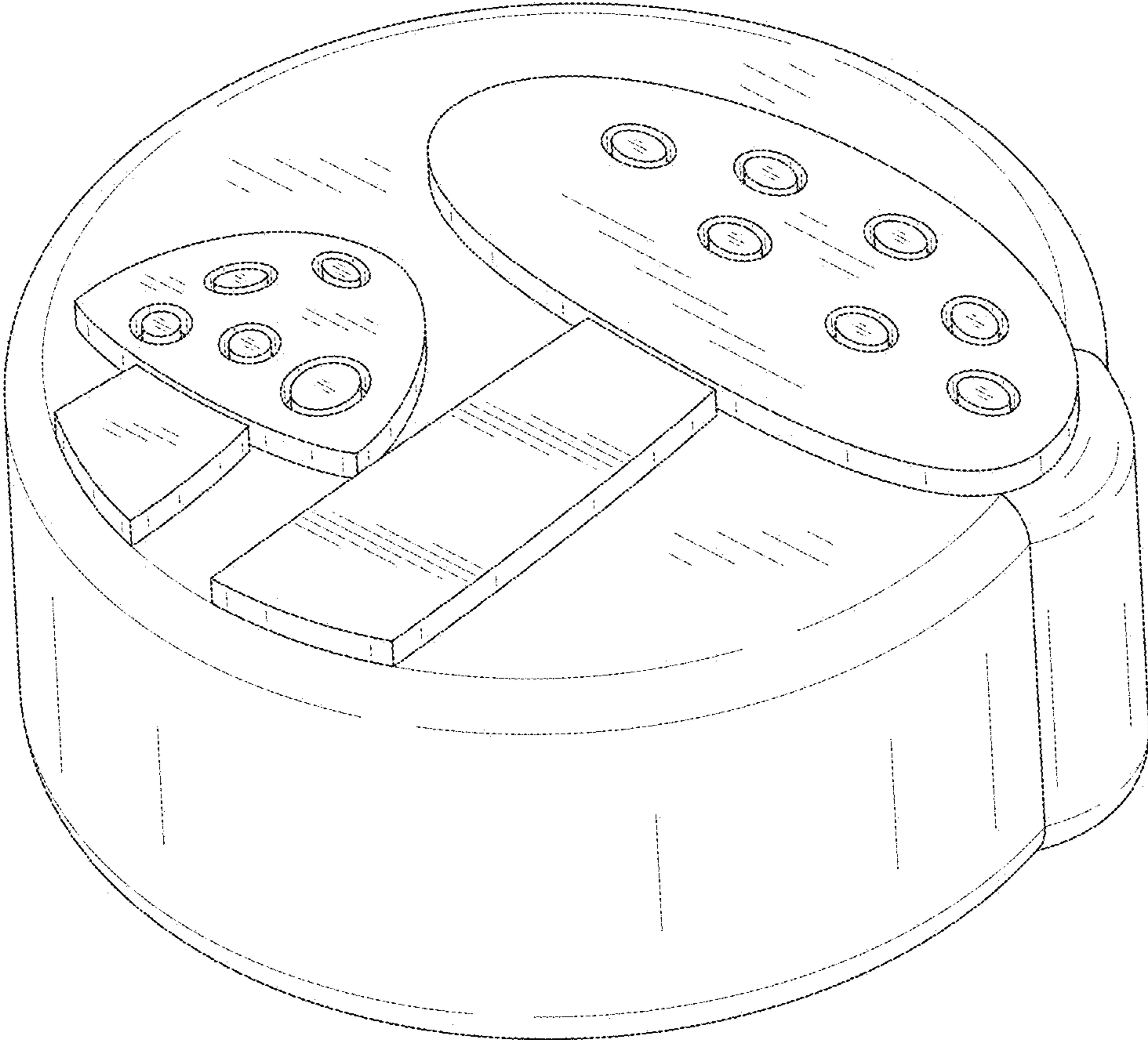

FIG. 1

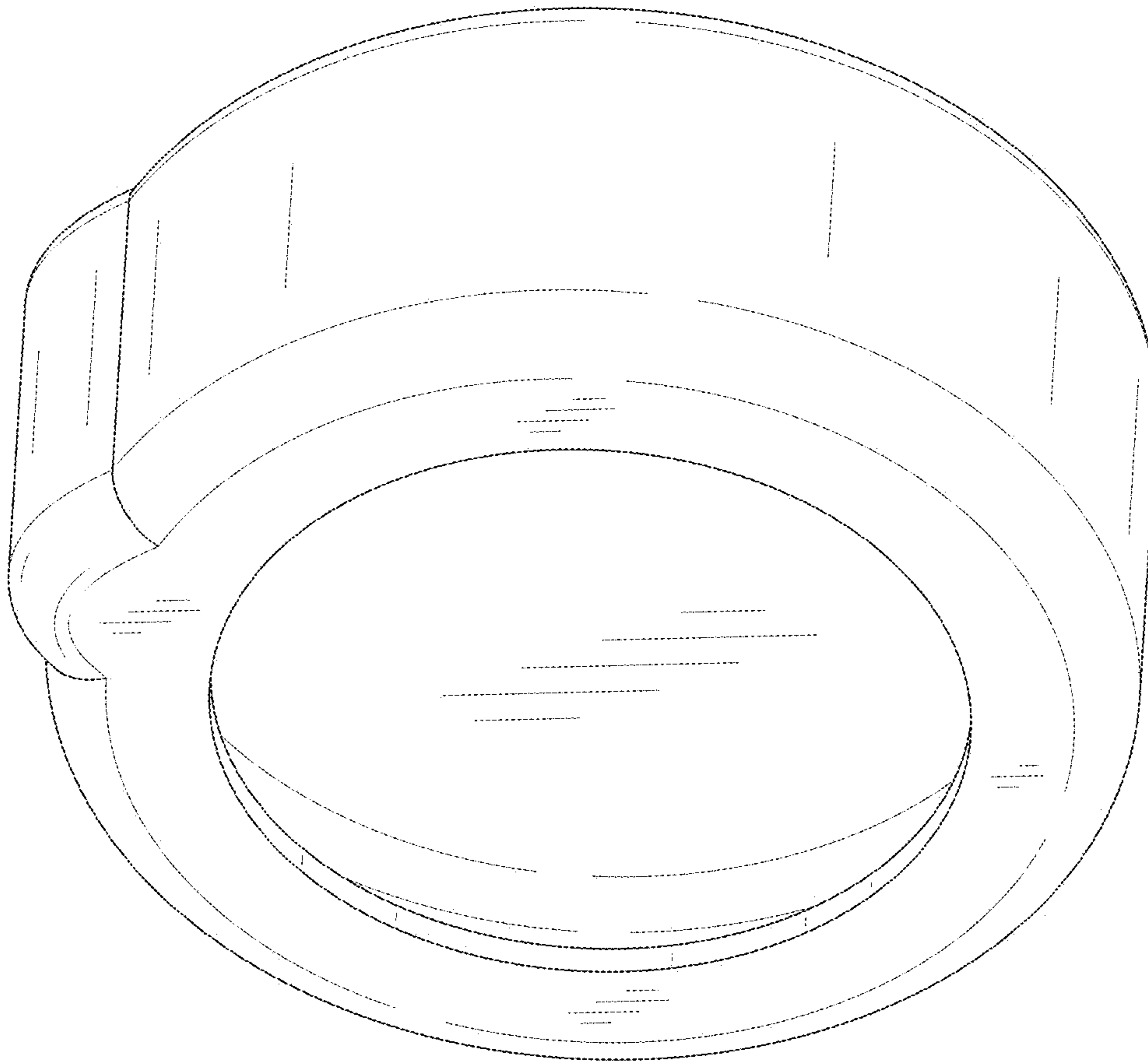

FIG. 2

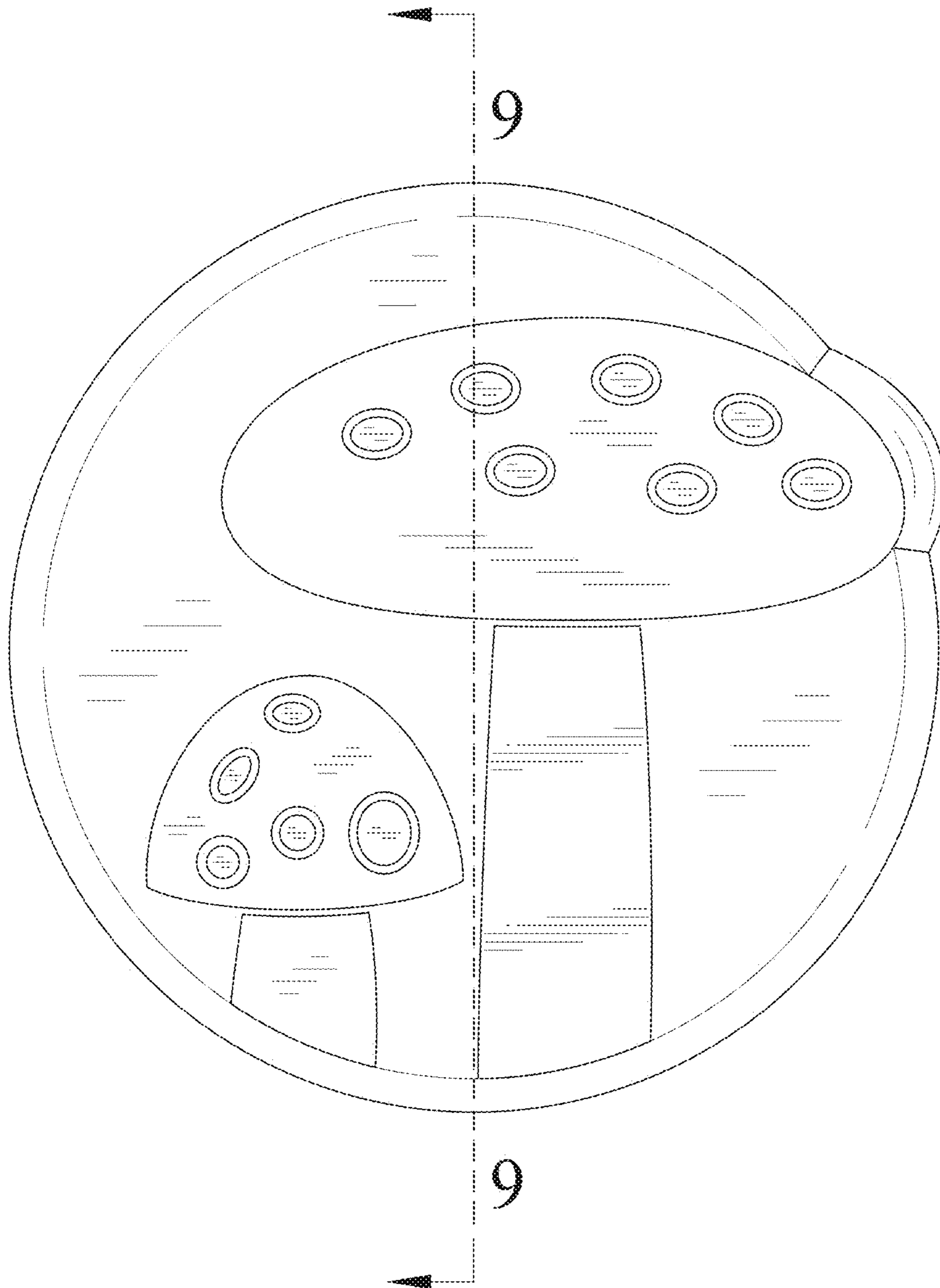

FIG. 3

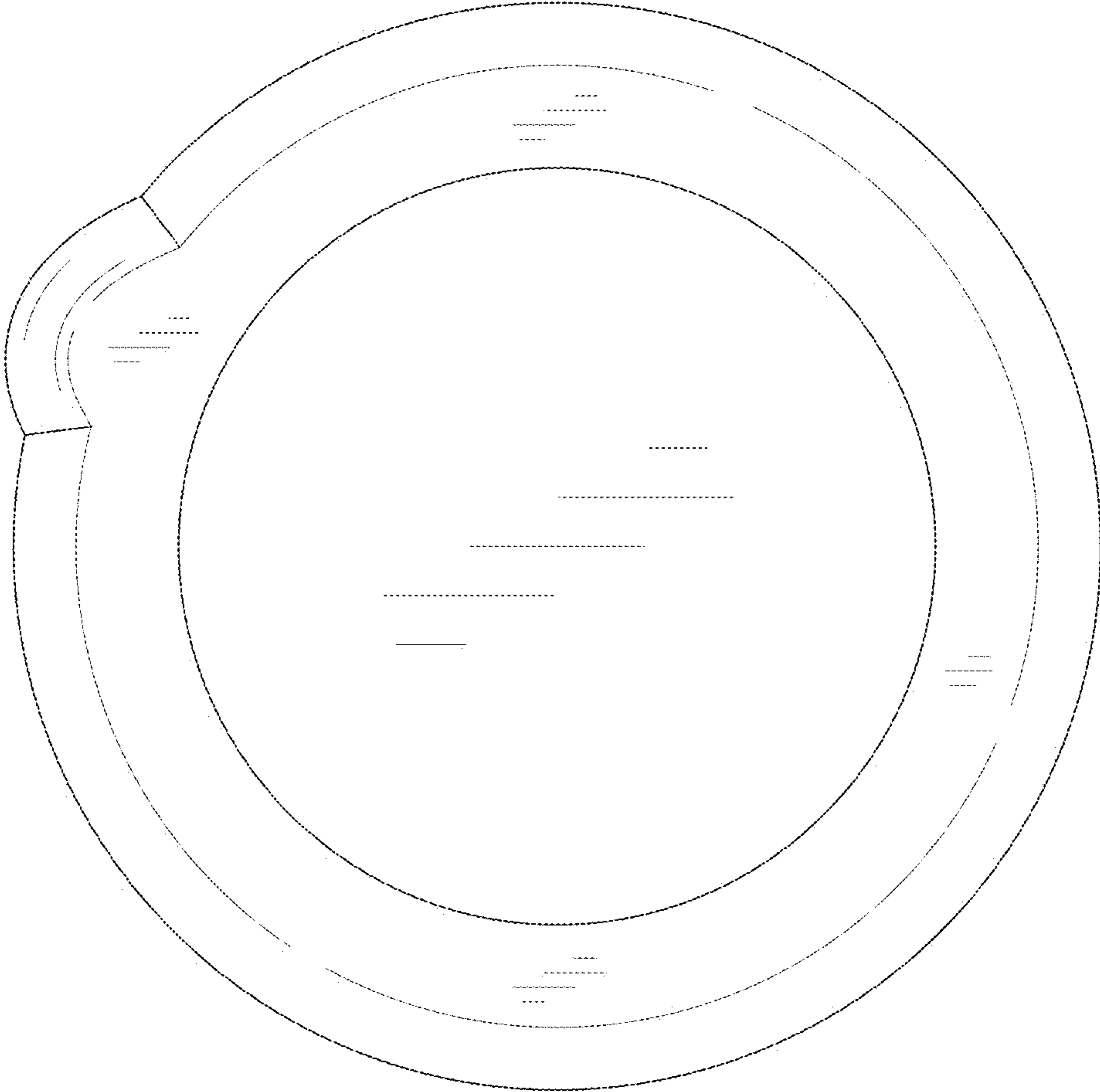

FIG. 4

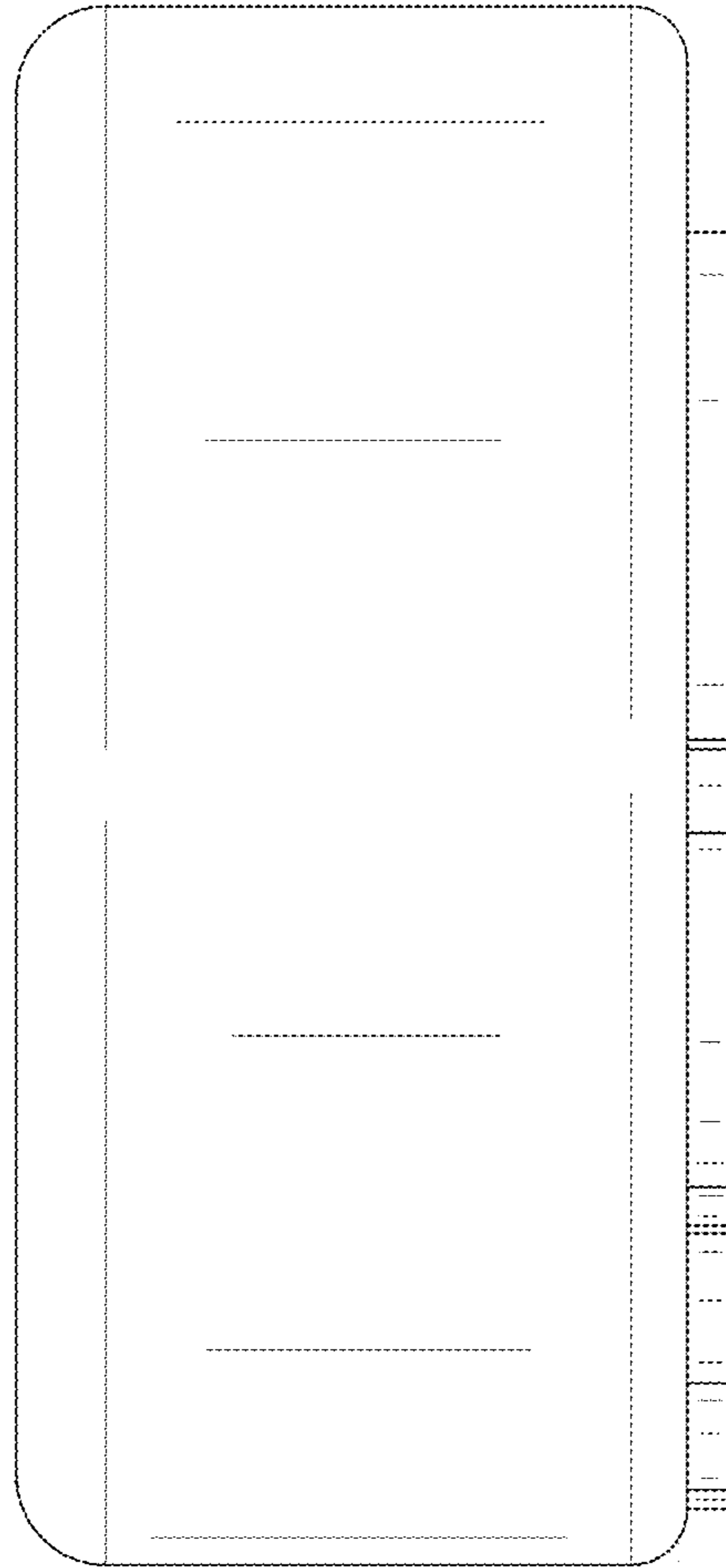

FIG. 5

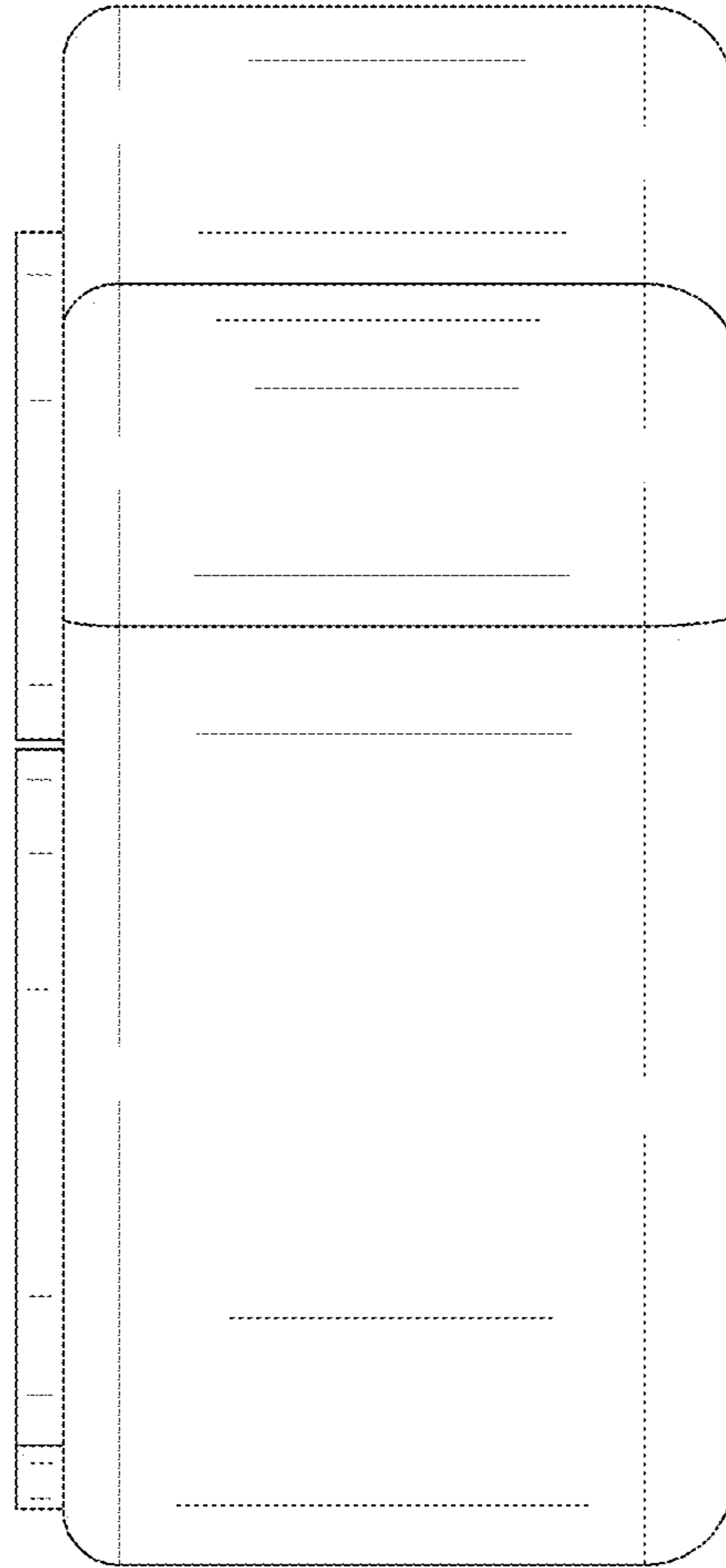

FIG. 6



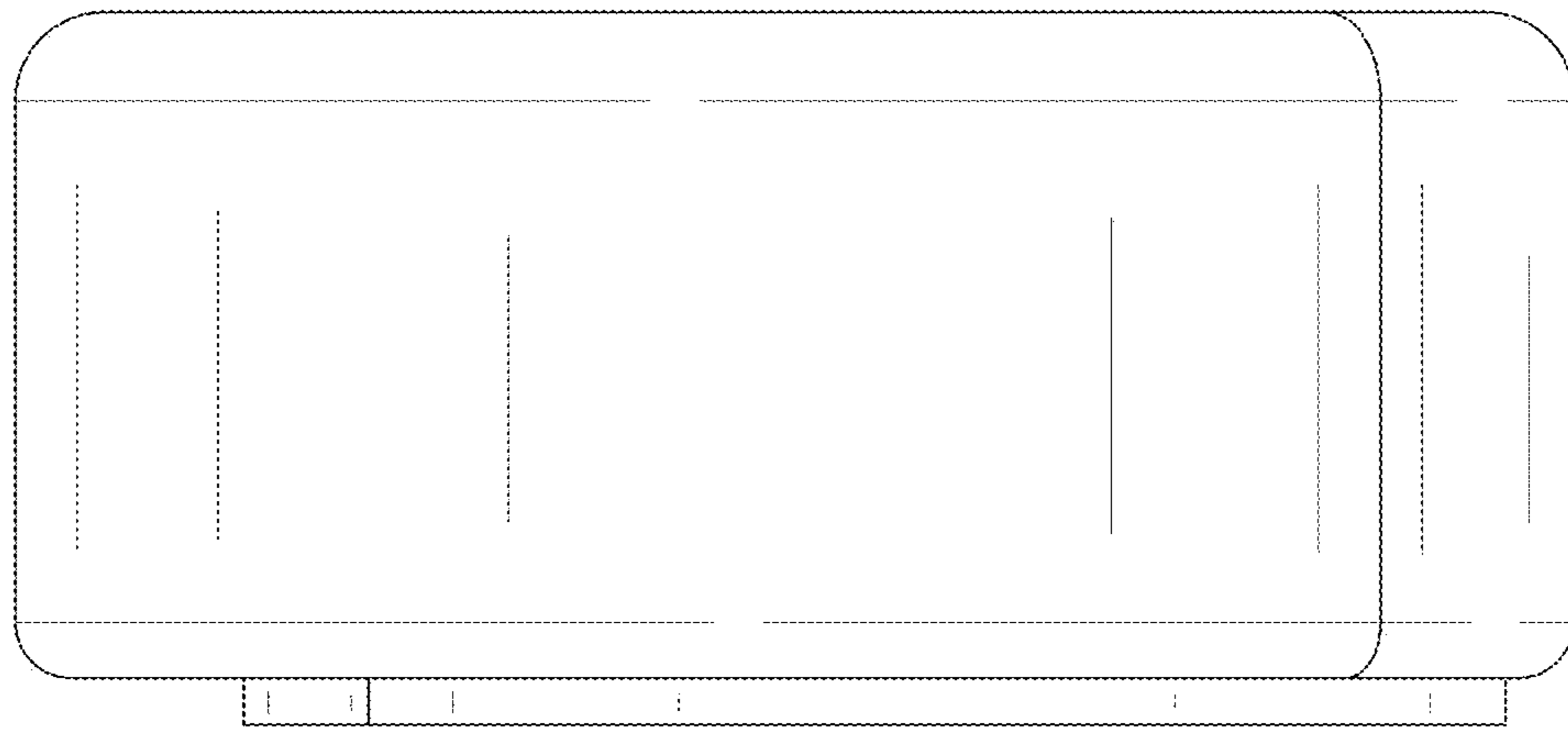

FIG. 7

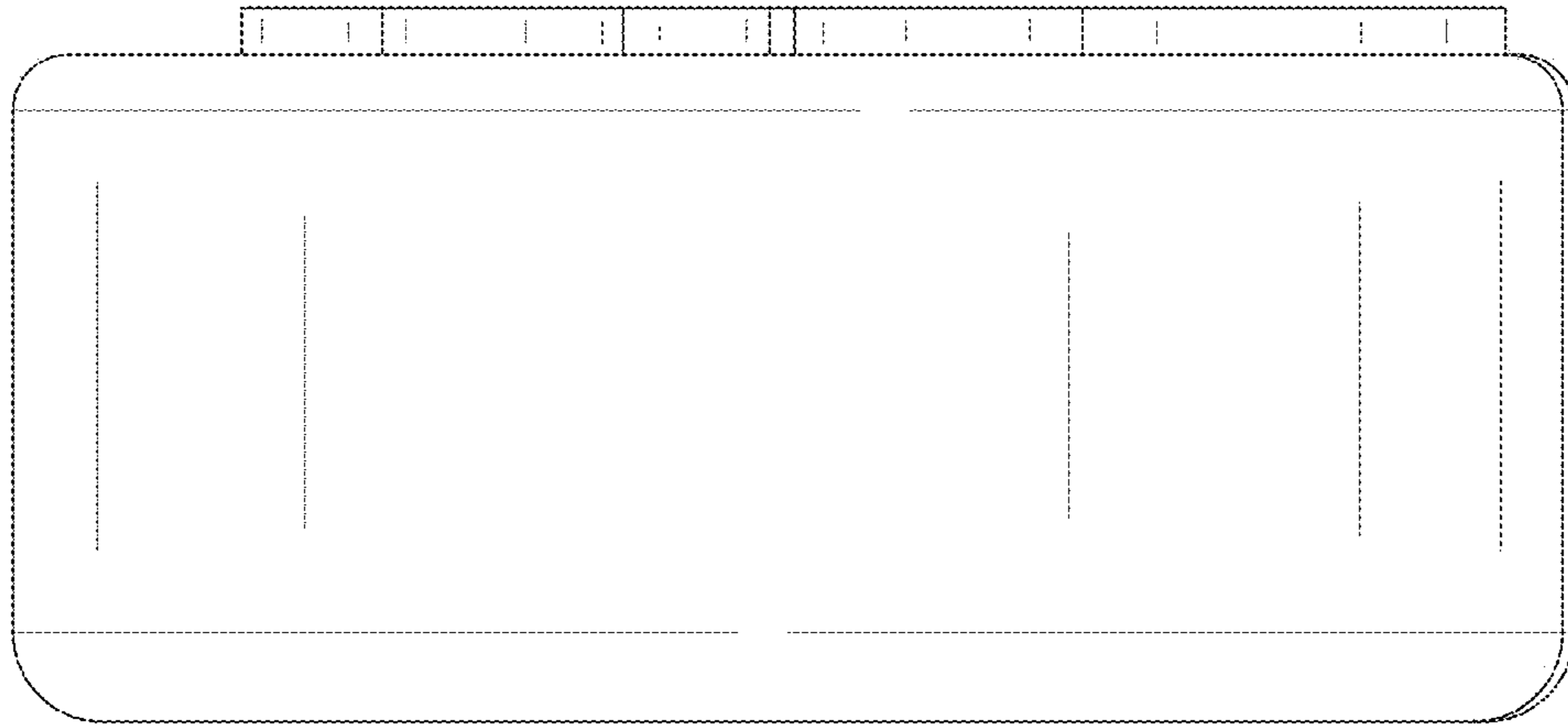

FIG. 8

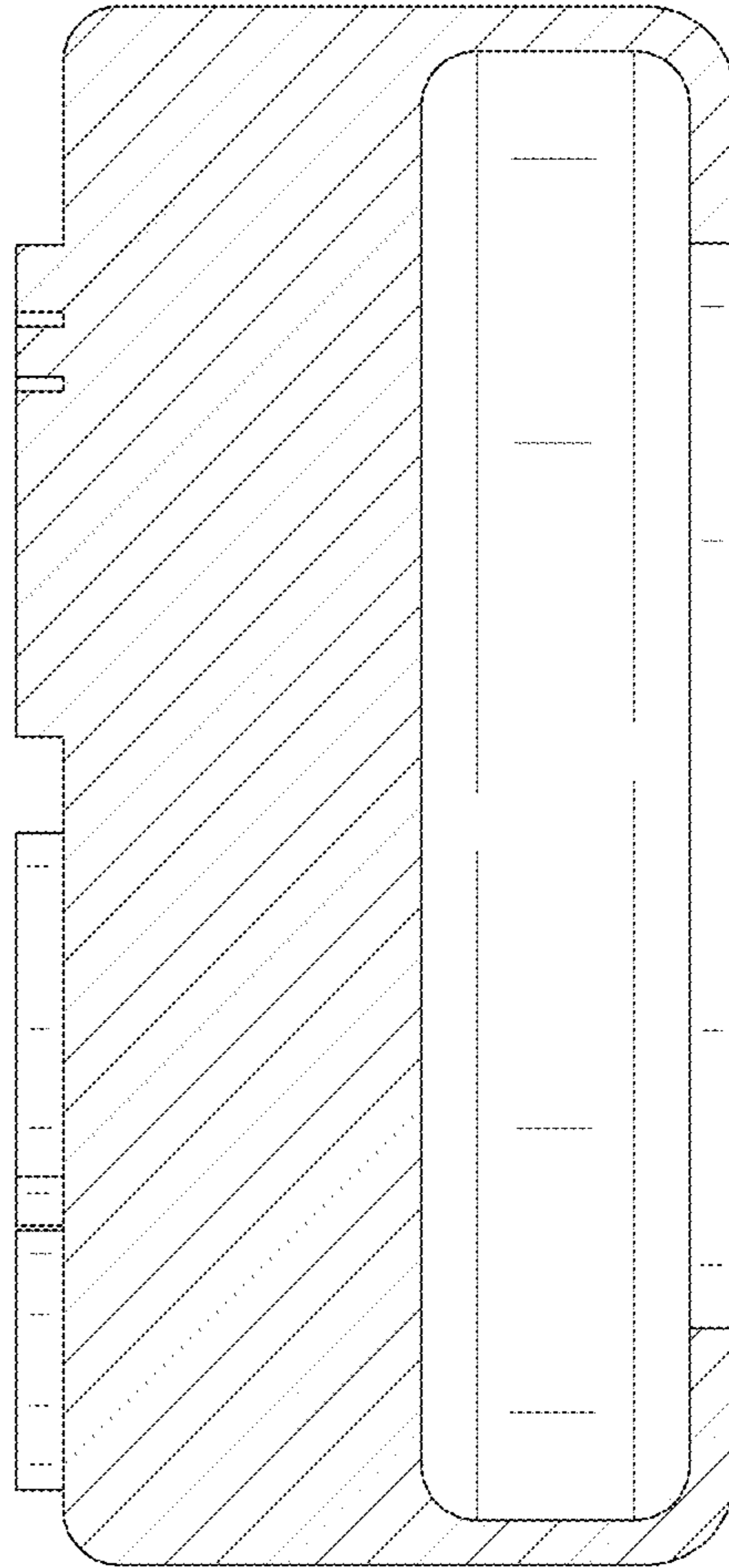

FIG. 9

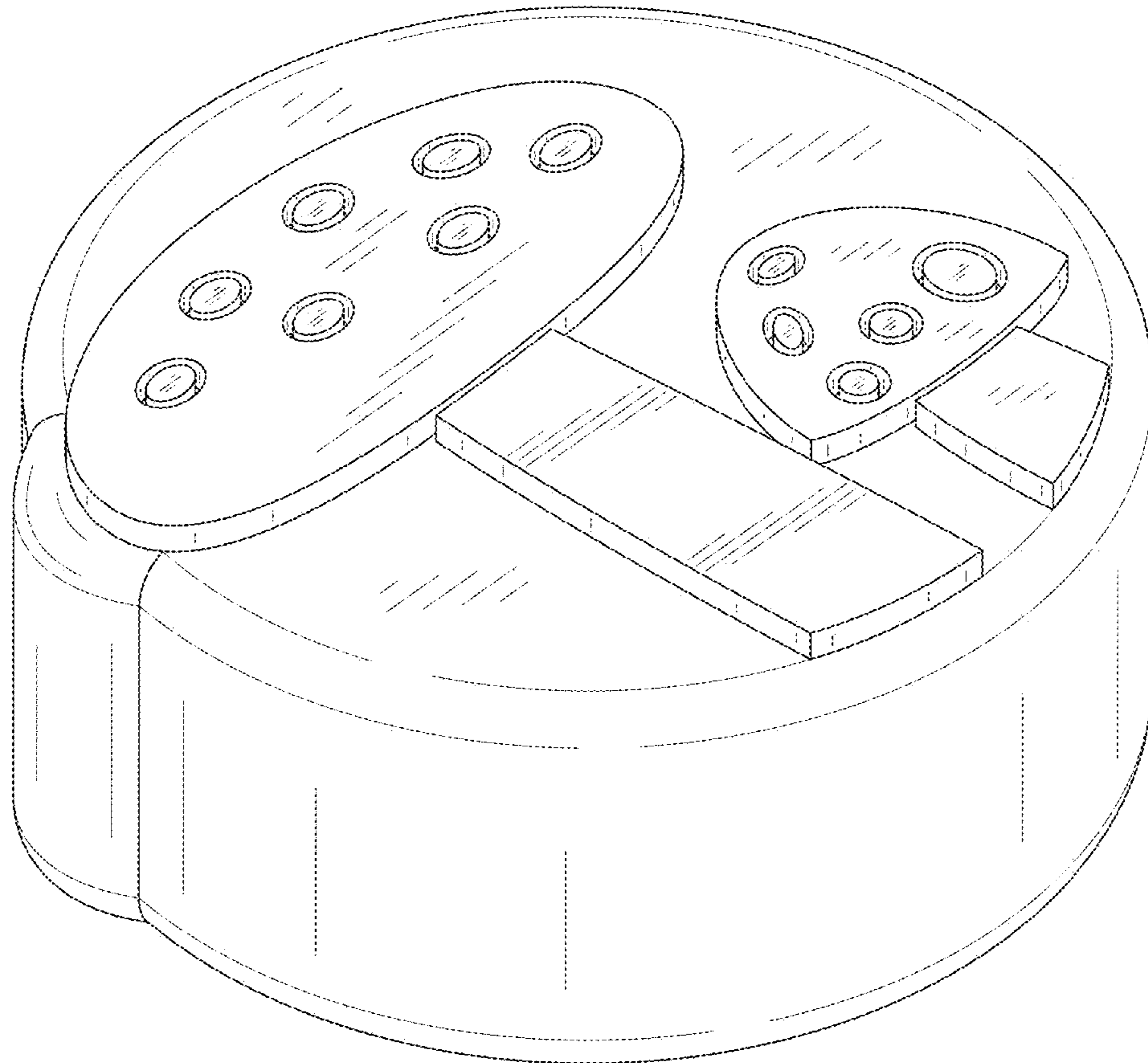

FIG. 10

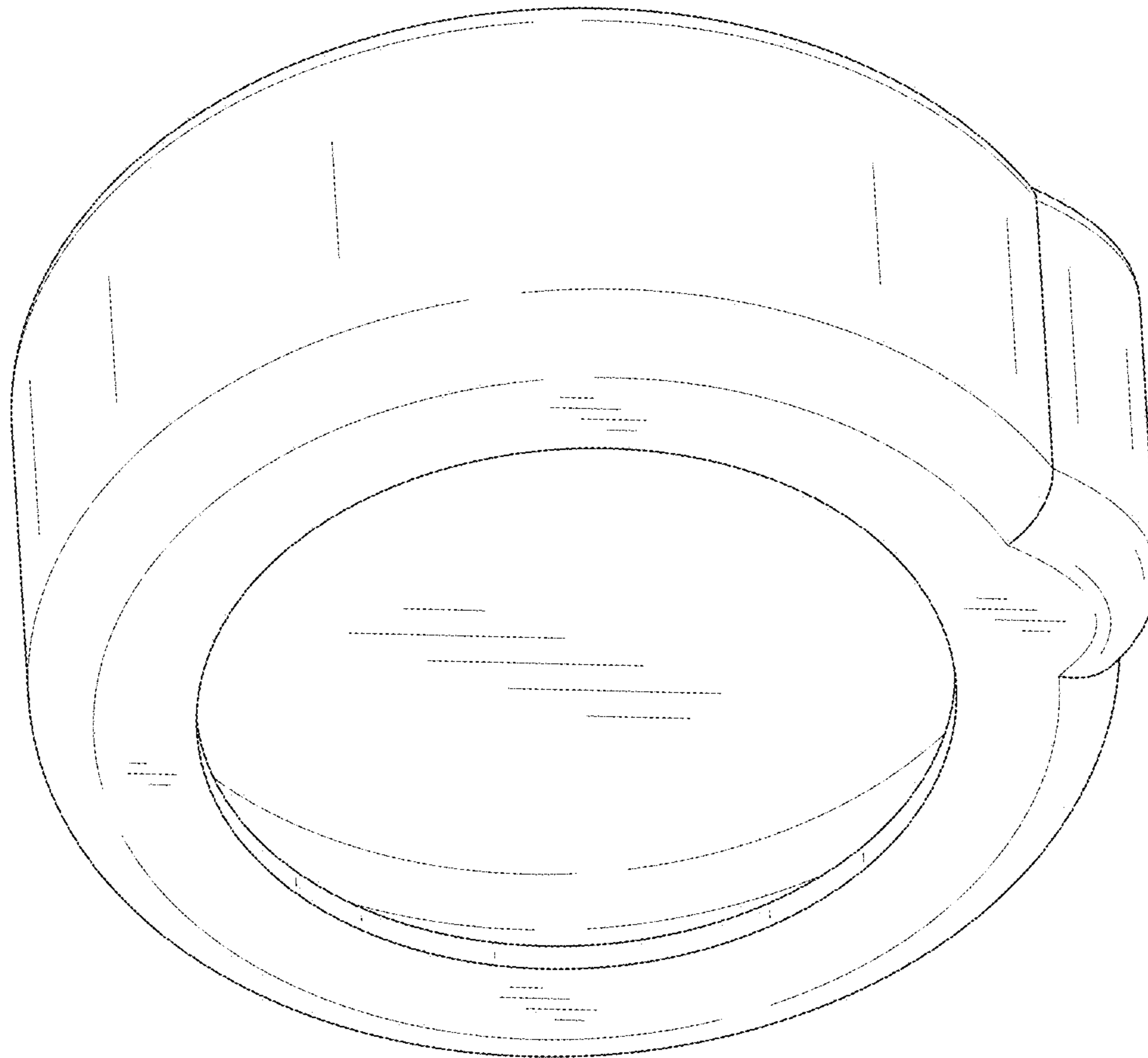

FIG. 11

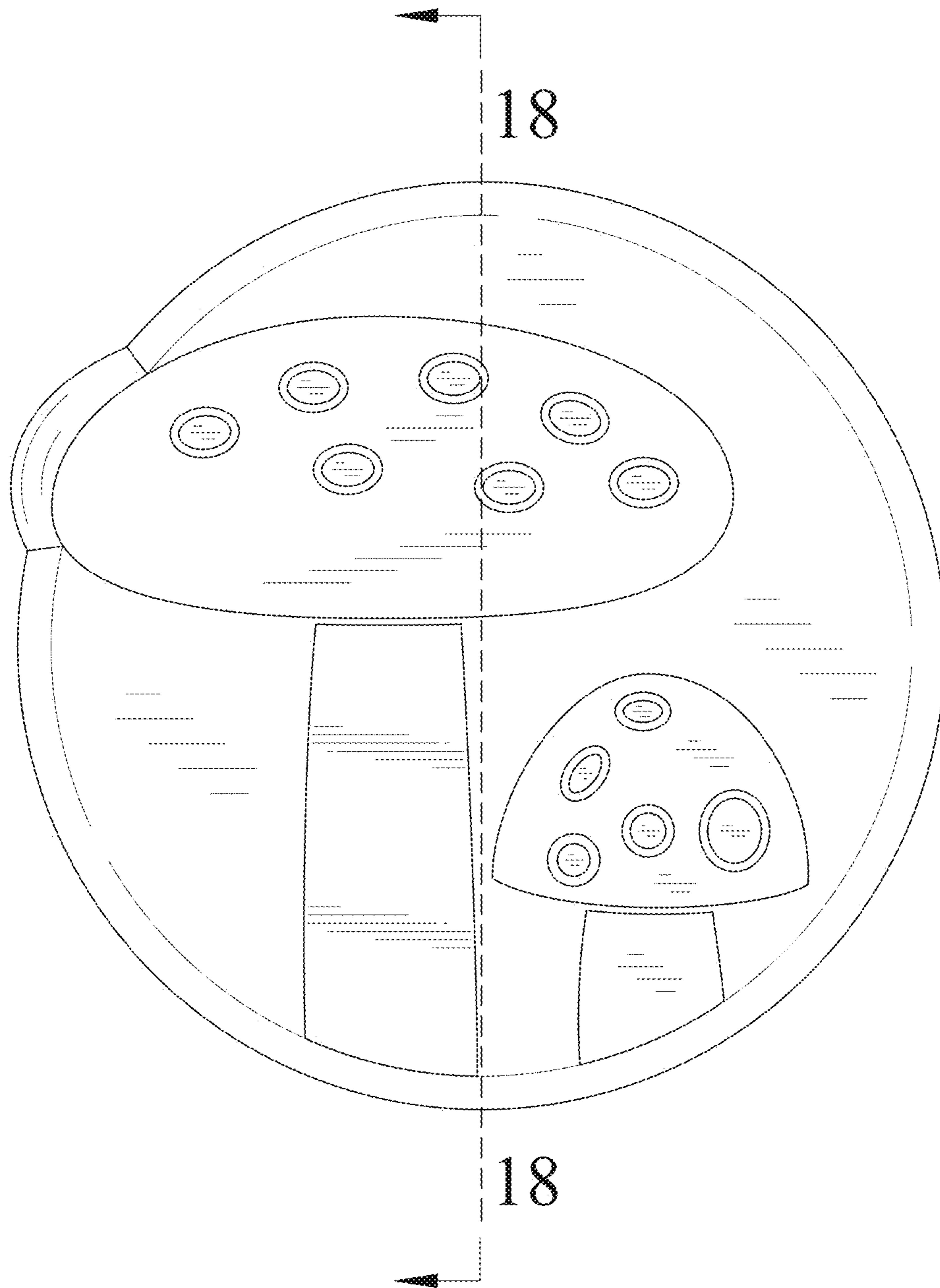

FIG. 12

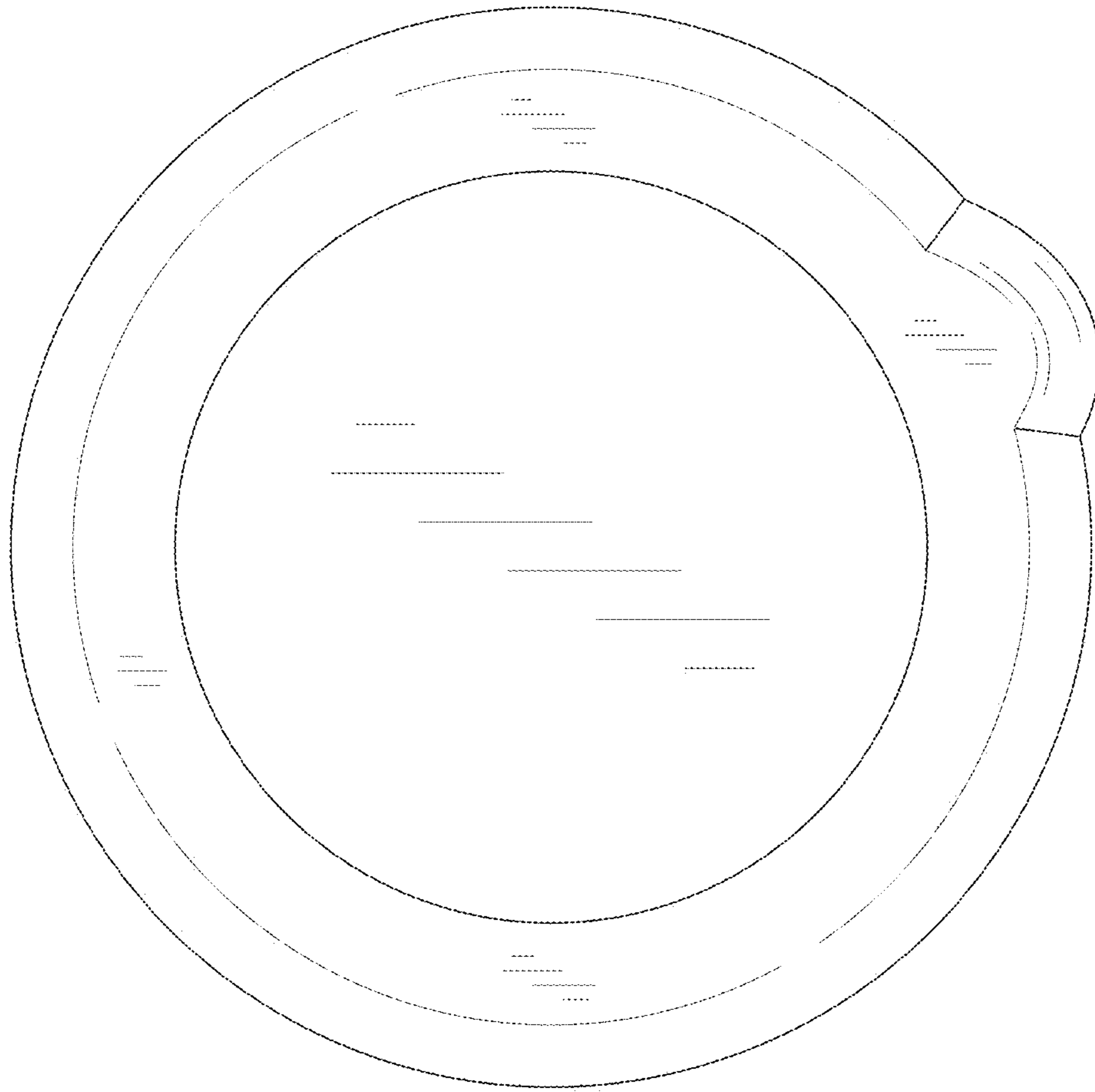

FIG. 13

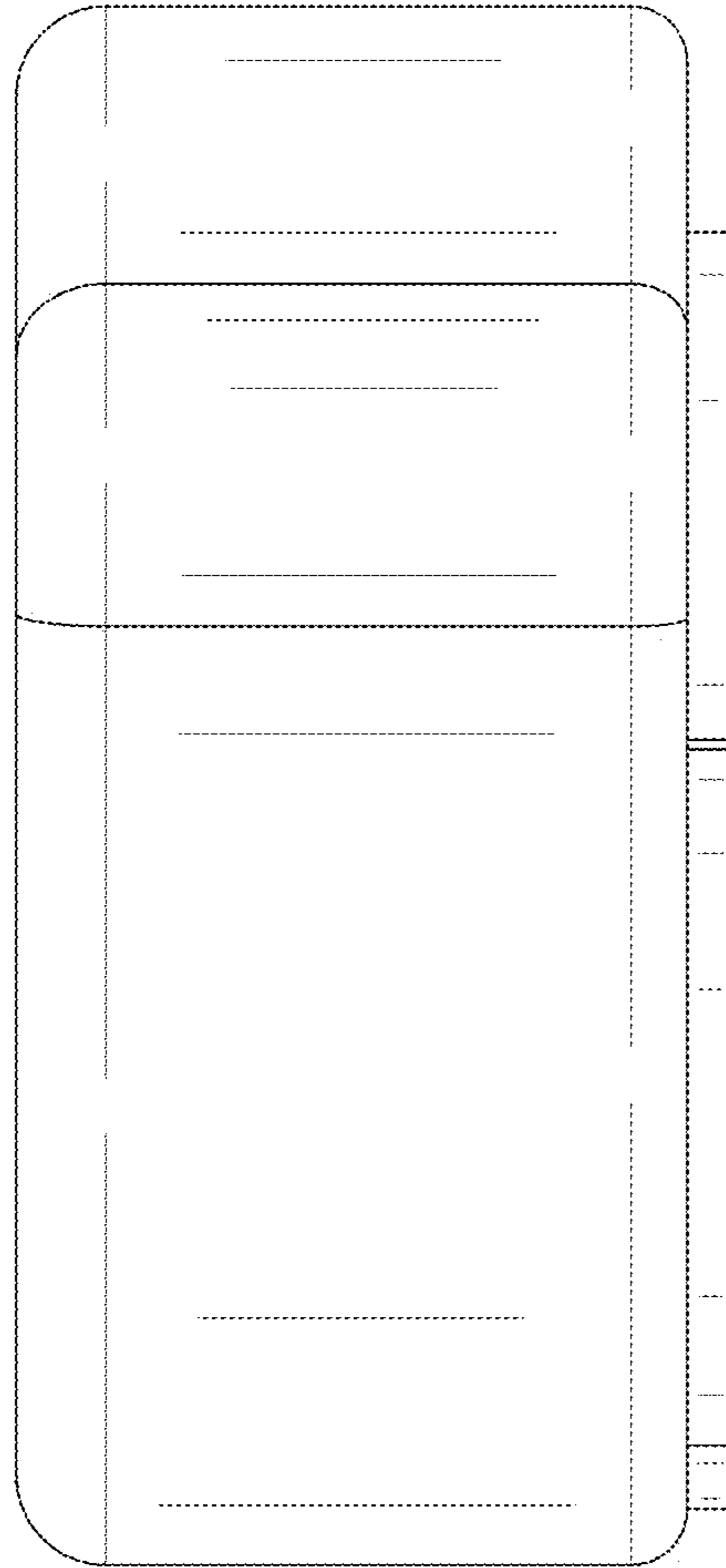

FIG. 14



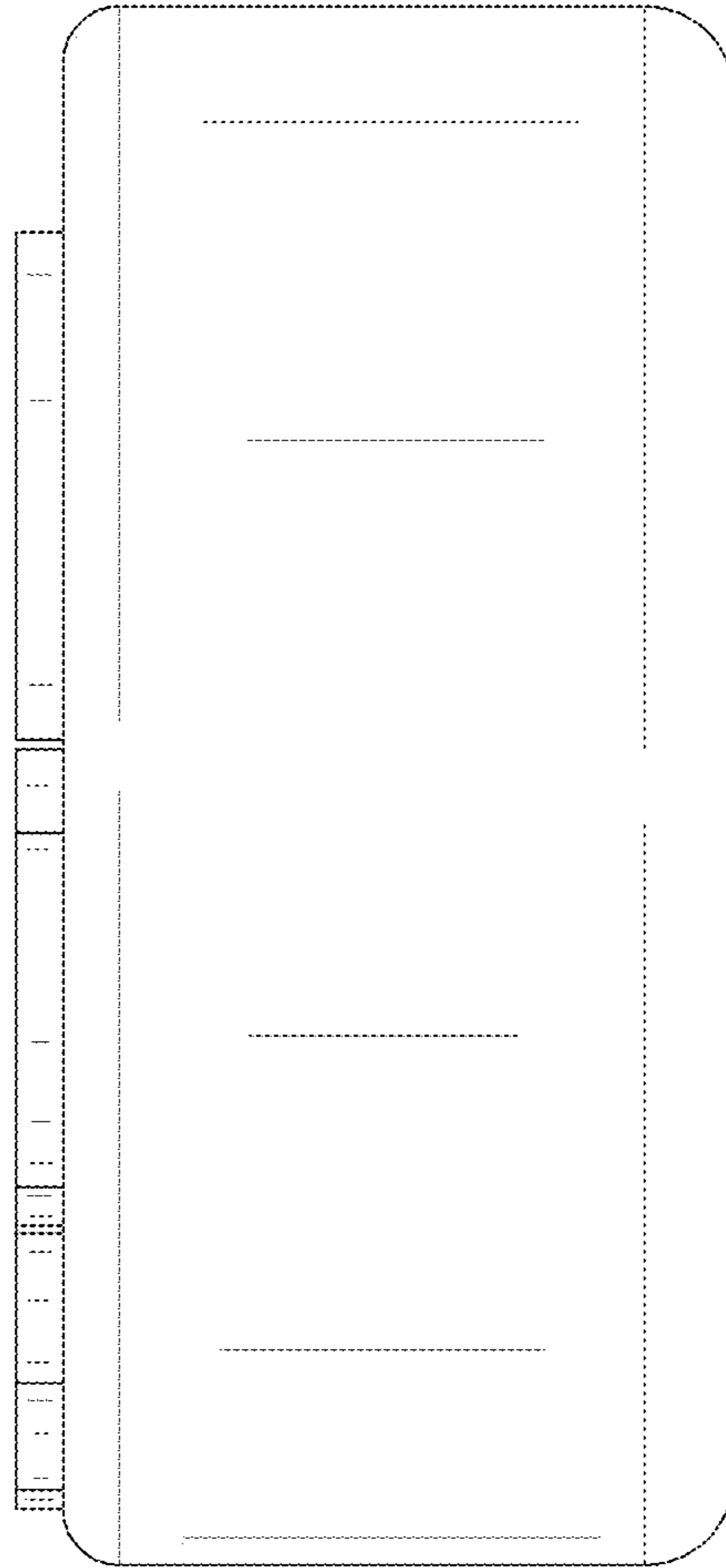

FIG. 15

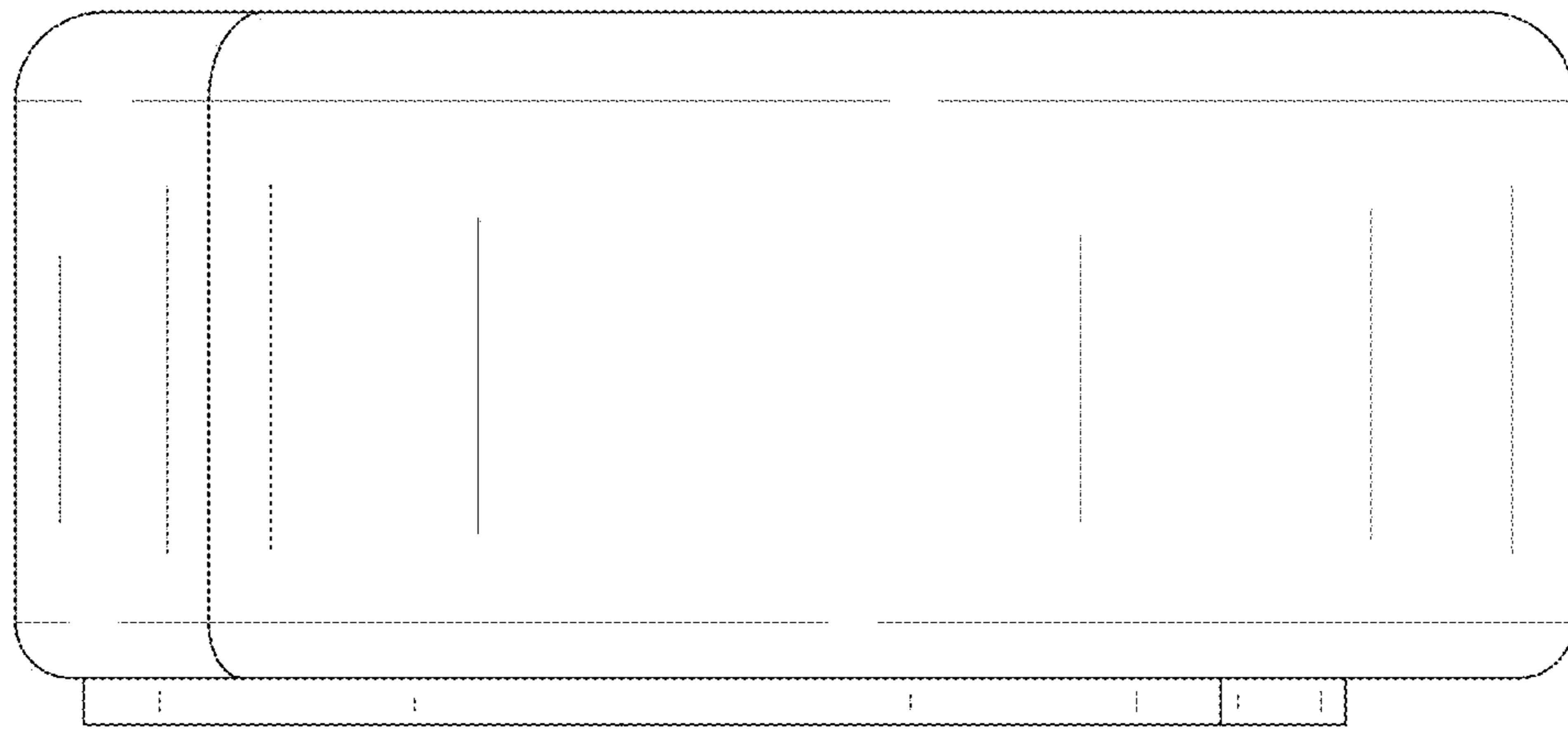

FIG. 16

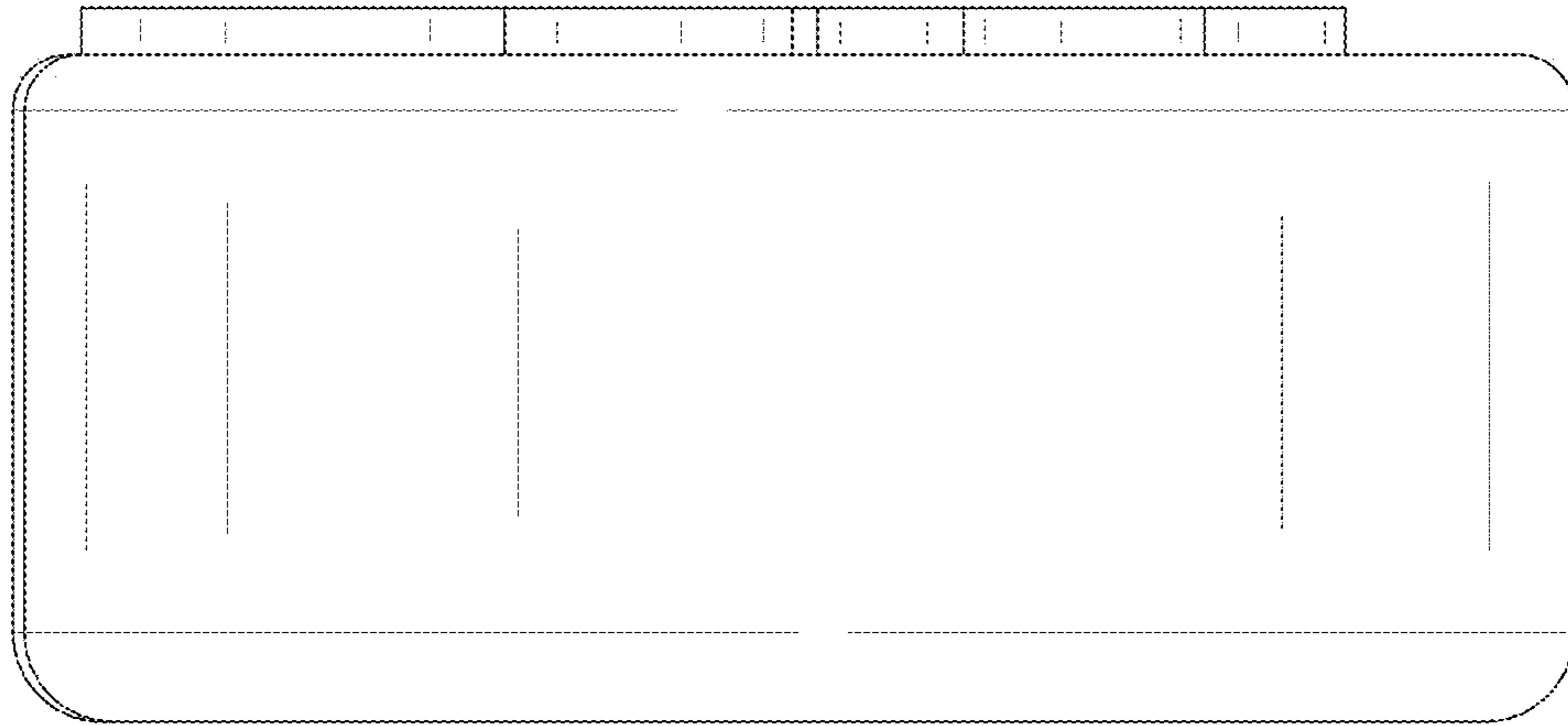

FIG. 17

A-A

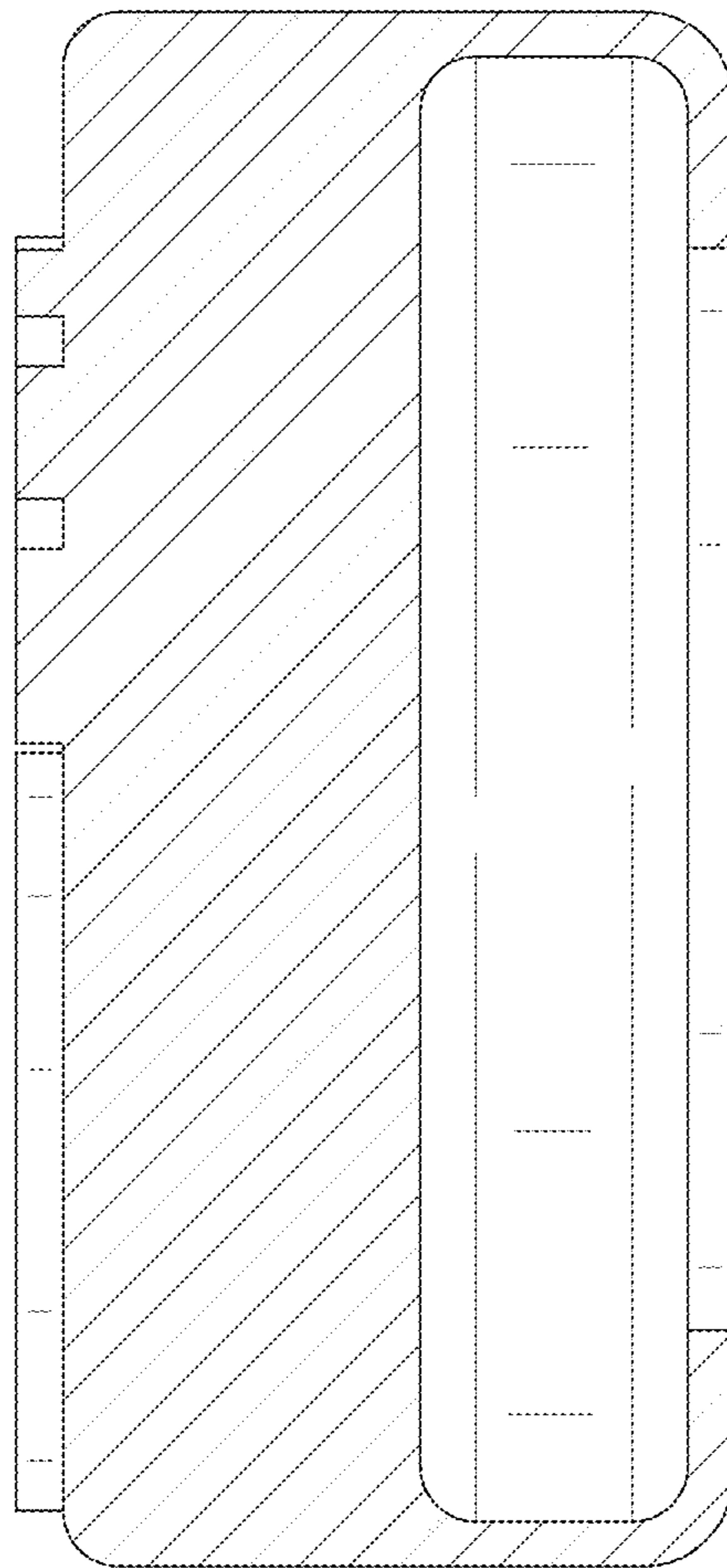

FIG. 18