



US00D966392S

(12) **United States Design Patent** (10) **Patent No.:** **US D966,392 S**  
**Shuai** (45) **Date of Patent:** **\*\* Oct. 11, 2022**

(54) **BABY MONITOR**

(71) Applicant: **Bin Shuai**, Yichun (CN)

(72) Inventor: **Bin Shuai**, Yichun (CN)

(73) Assignee: **Bin Shuai**, Yichun (CN)

(\*\*) Term: **15 Years**

(21) Appl. No.: **29/762,723**

(22) Filed: **Dec. 18, 2020**

(51) **LOC (13) Cl.** ..... **16-01**

(52) **U.S. Cl.**

USPC ..... **D16/203**

(58) **Field of Classification Search**

USPC ..... D16/200–204, 207–208, 218–219;  
D10/46, 61, 62, 65, 70, 71, 104.1, 106.6,  
D10/106.7; D14/203.1, 204, 209.1, 496  
CPC ..... G03B 15/03; G03B 17/02; G03B 17/04;  
G03B 17/56; G03B 19/04; H04N 7/141;  
H04N 7/142; H04N 7/147; H04N 7/148;  
H04N 7/15; H04N 7/152; H04N 5/2251;  
H04N 5/2252; H04N 5/2253; H04N  
5/2254; H04N 5/23216; H04N 5/232939;  
H04N 2101/00; H04N 2007/145

See application file for complete search history.

(56) **References Cited**

**U.S. PATENT DOCUMENTS**

D470,874 S \* 2/2003 Chiu ..... D16/202  
D627,815 S \* 11/2010 Oba ..... D16/202  
D651,633 S \* 1/2012 Park ..... D16/203  
D804,561 S \* 12/2017 Luo ..... D16/202  
D840,368 S \* 2/2019 Deng ..... D16/203  
D874,536 S \* 2/2020 Park ..... D10/104.1  
D896,870 S \* 9/2020 Li ..... D16/203  
D900,907 S \* 11/2020 Zhou ..... D16/203

D903,737 S \* 12/2020 Han ..... D16/202  
D914,784 S \* 3/2021 Wei ..... D16/203  
D914,785 S \* 3/2021 Wei ..... D16/203

**FOREIGN PATENT DOCUMENTS**

CN 304717501 \* 7/2018  
CN 306532853 \* 5/2021  
CN 306579457 \* 6/2021

**OTHER PUBLICATIONS**

“Video Baby Monitor with Camera and Audio, 4.3 inch Baby Monitor with Night Vision, 2-Way Audio Talk, Temperature Sensor, VOX Mode, 8 Lullabies, Long Range and High Capacity Battery, Ideal for New Moms” from Amazon.com, first available Sep. 28, 2021 from the internet<<https://www.amazon.com/dp/B09HCFGD8N/>> (Year: 2021).\*

(Continued)

*Primary Examiner* — Elizabeth J Oswecki

*Assistant Examiner* — Lacey Chey Bowman

(74) *Attorney, Agent, or Firm* — Nitin Kaushik

(57)

**CLAIM**

The ornamental design for a baby monitor, as shown and described.

**DESCRIPTION**

FIG. 1 is a perspective view of a baby monitor showing my new design;

FIG. 2 is a front elevational view thereof;

FIG. 3 is a rear elevational view thereof;

FIG. 4 is a left elevational view thereof;

FIG. 5 is a right elevational view thereof;

FIG. 6 is a top plan view thereof; and,

FIG. 7 is a bottom plan view thereof.

The broken lines shown in the drawings illustrate portions of the baby monitor that form no part of the claimed design.

**1 Claim, 7 Drawing Sheets**

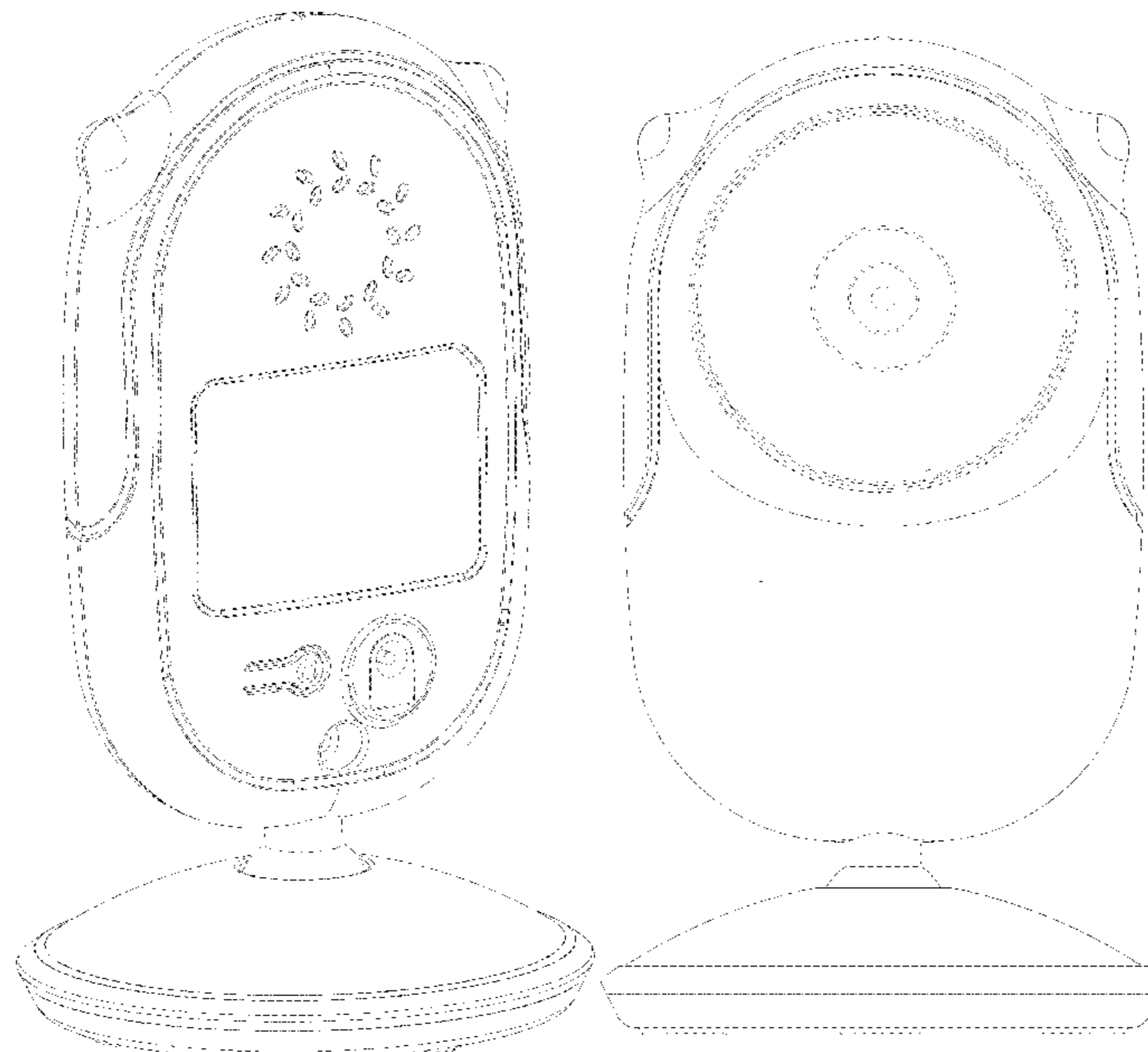

(56)

**References Cited**

OTHER PUBLICATIONS

“Simyke Video Baby Monitor with 2 Cameras and Audio 3.5” LCD Digital Display with 2 Way Talk ,Infrared Night Vision,2X Zoomin Temperature Detect VOX Auto Lullaby Baby Monitoring” from Amazon.com, first available Mar. 6, 2020 from the internet <<https://www.amazon.com/dp/B085L6647P/>> (Year: 2020).\*

“Newbaby Video Baby Monitor with Digital Color Camera, Wire-less View Video, Two-Way Talk, Lullabies, Infrared Night Vision, Temperature Monitoring, Feeding Alarm (WhiteSM25) SM25” from Amazon.com, first available Dec. 17, 2020 from the internet <<https://www.amazon.com/dp/B09F93G687/>> (Year: 2020).\*

\* cited by examiner

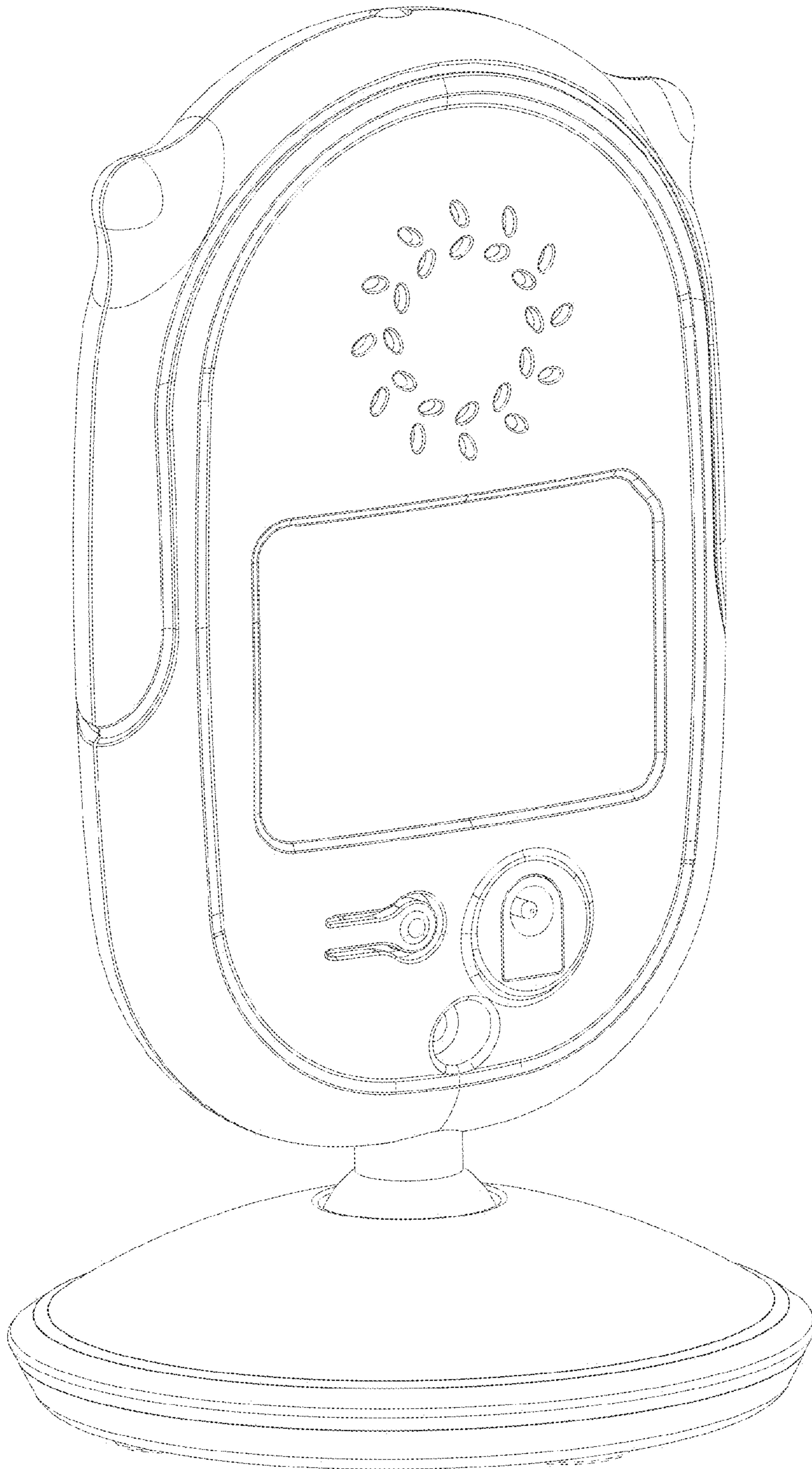

FIG. 1

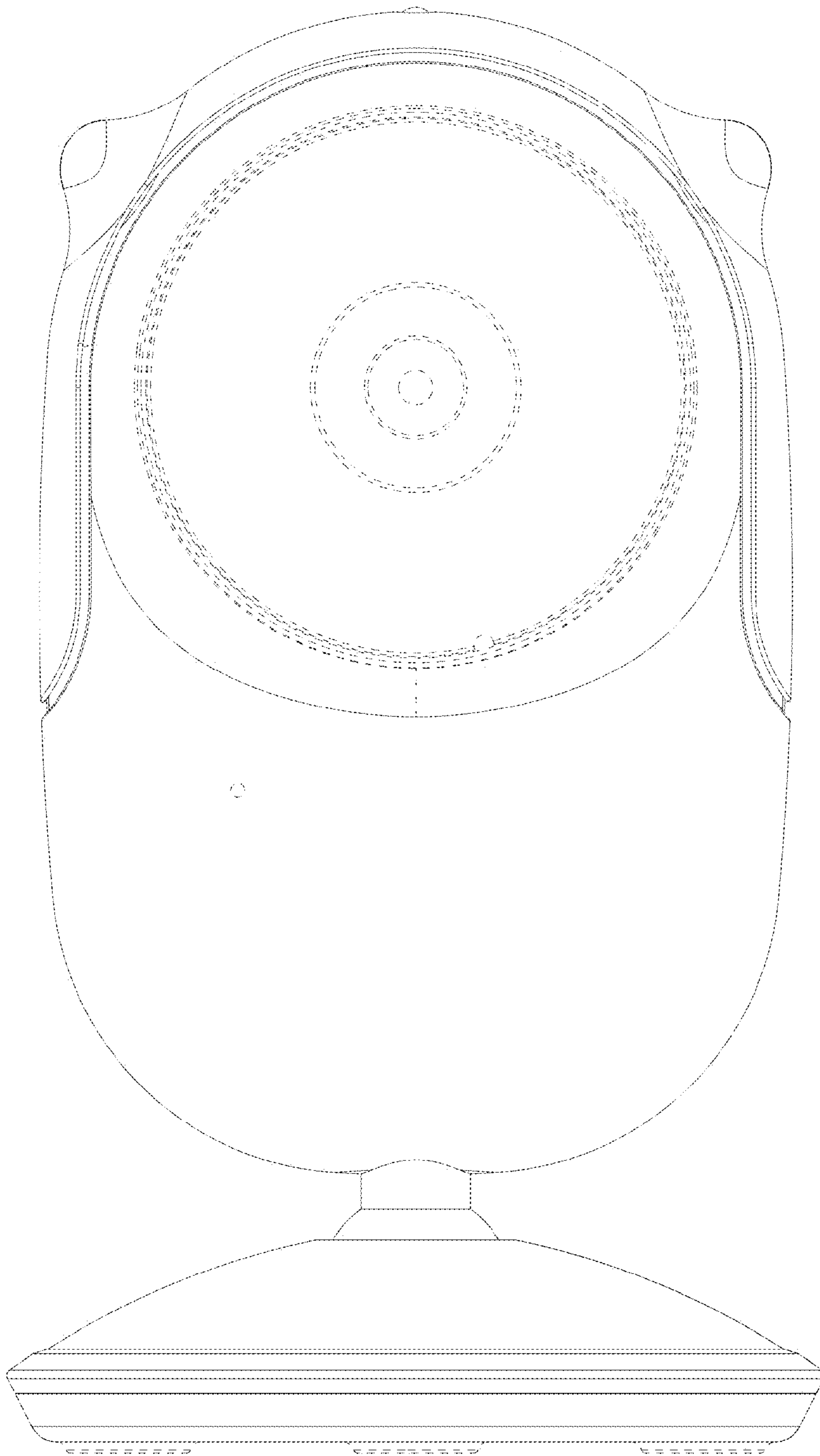

FIG. 2

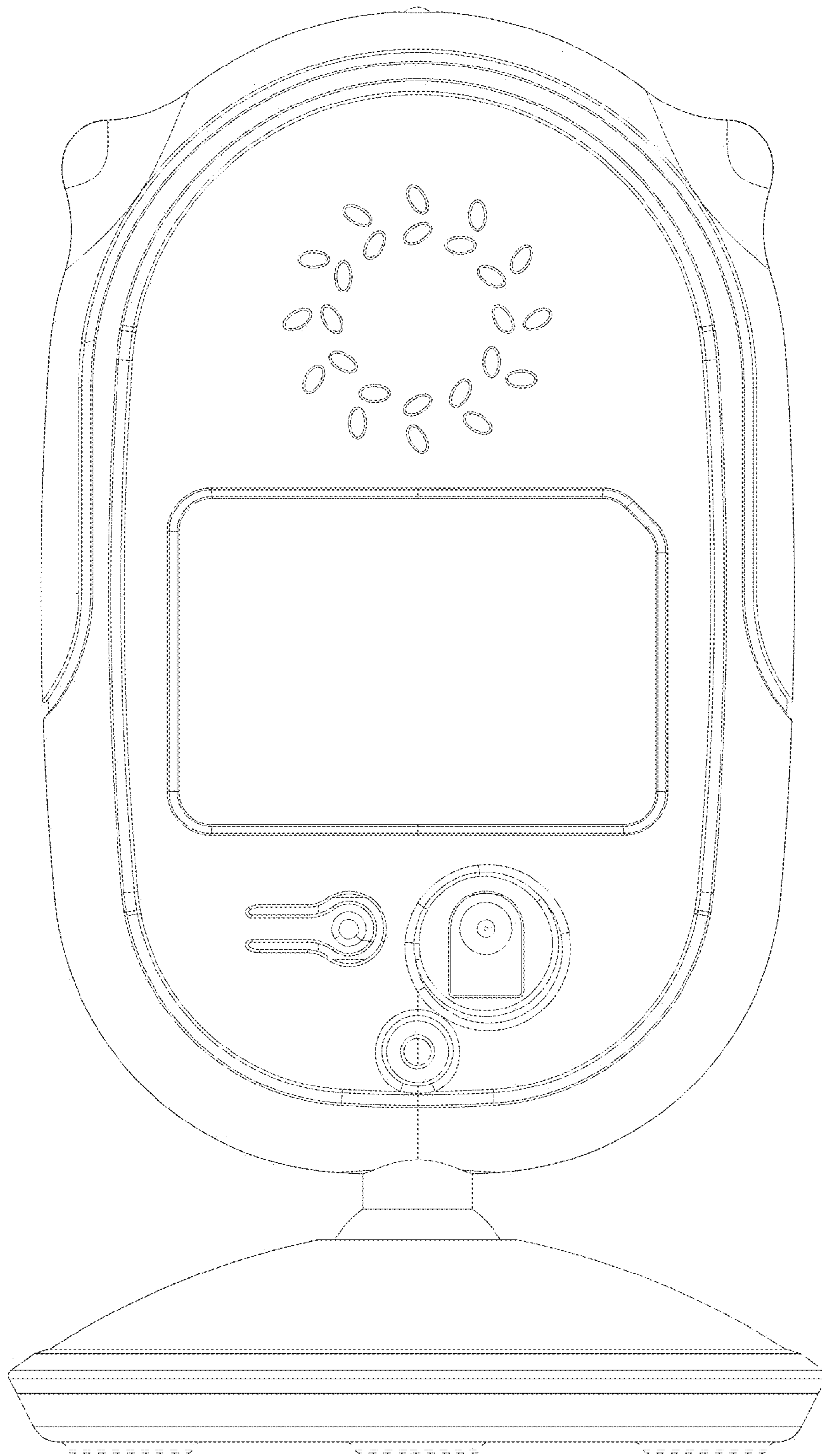

FIG. 3

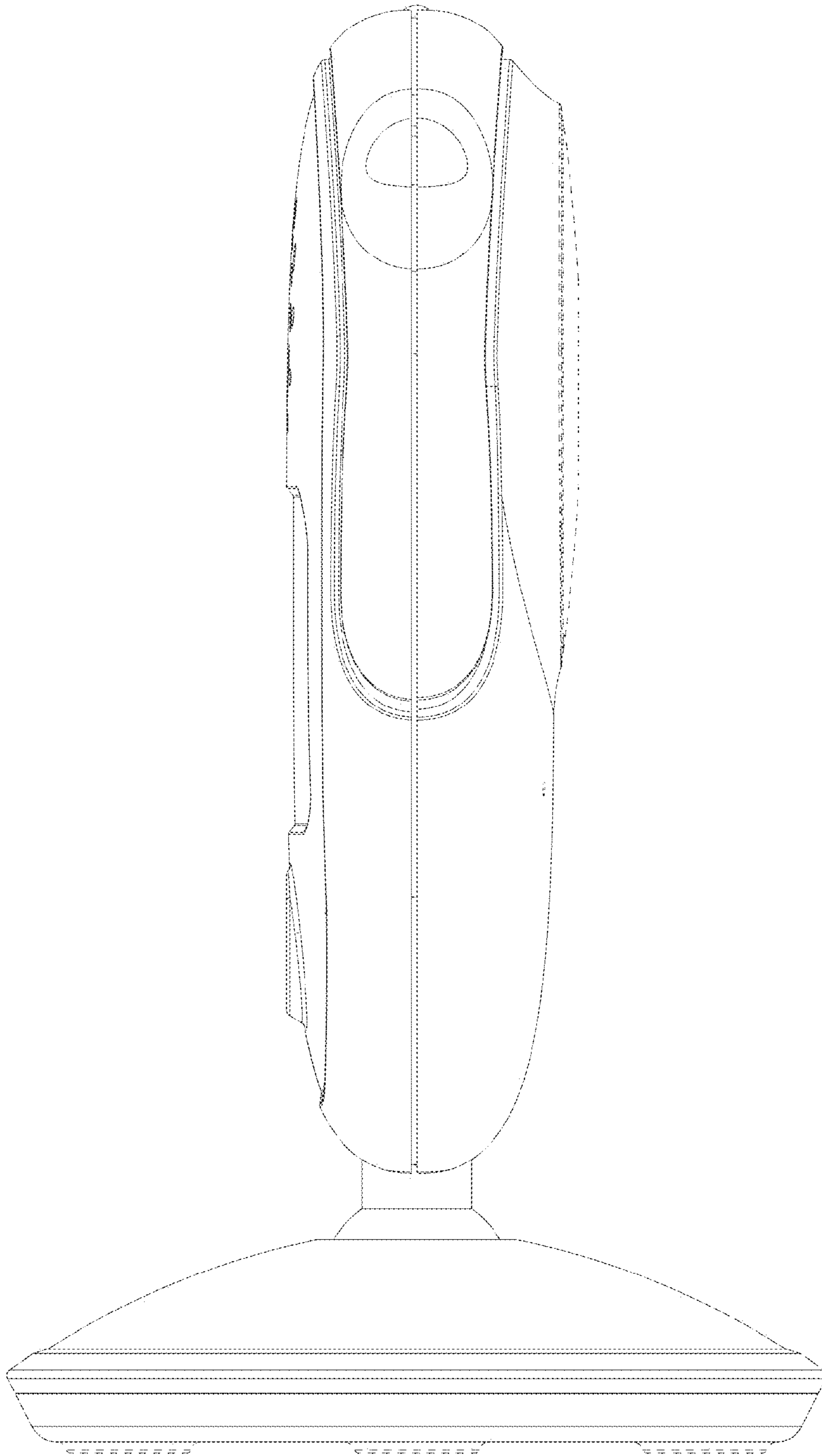

FIG. 4

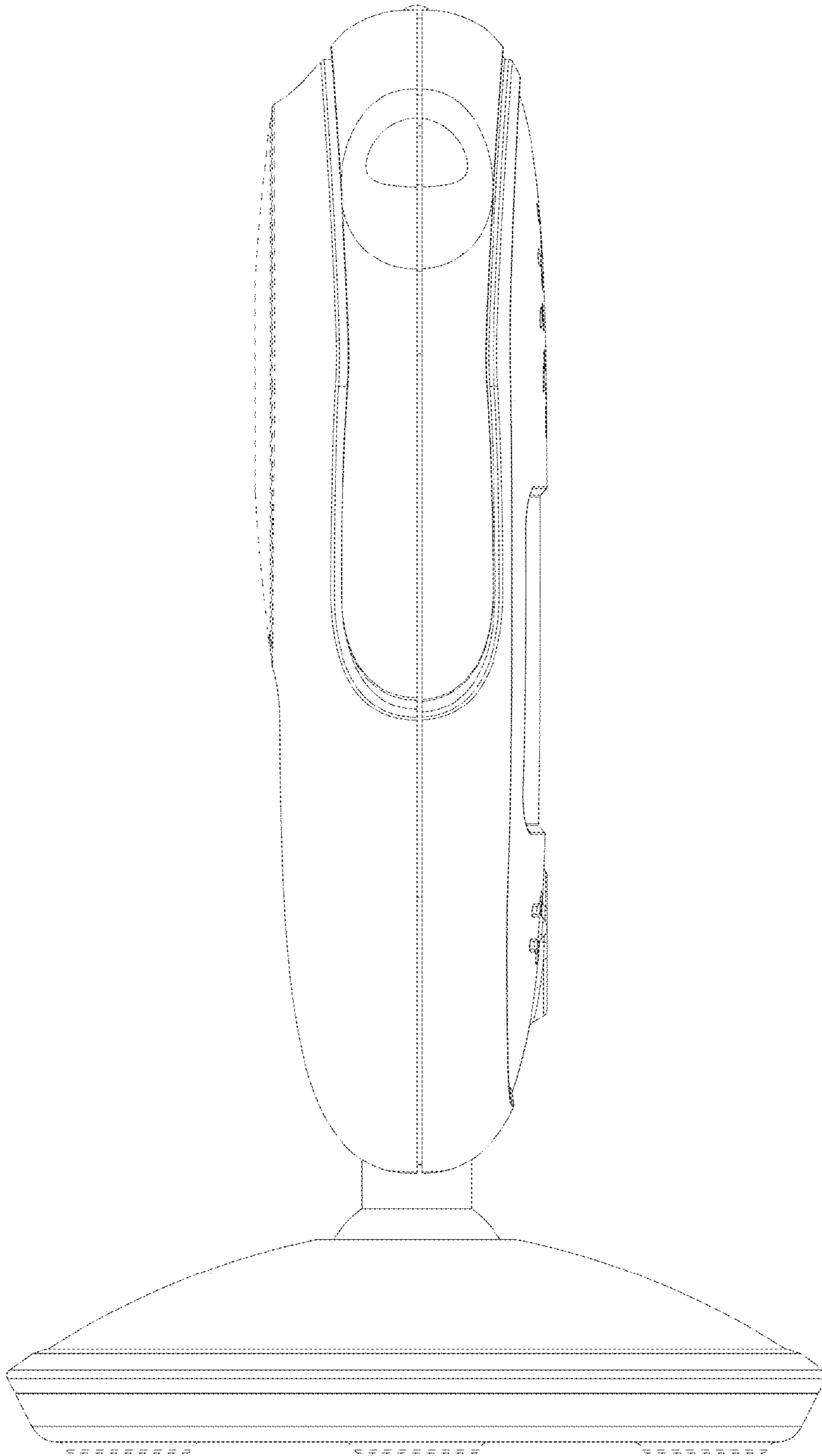

FIG. 5

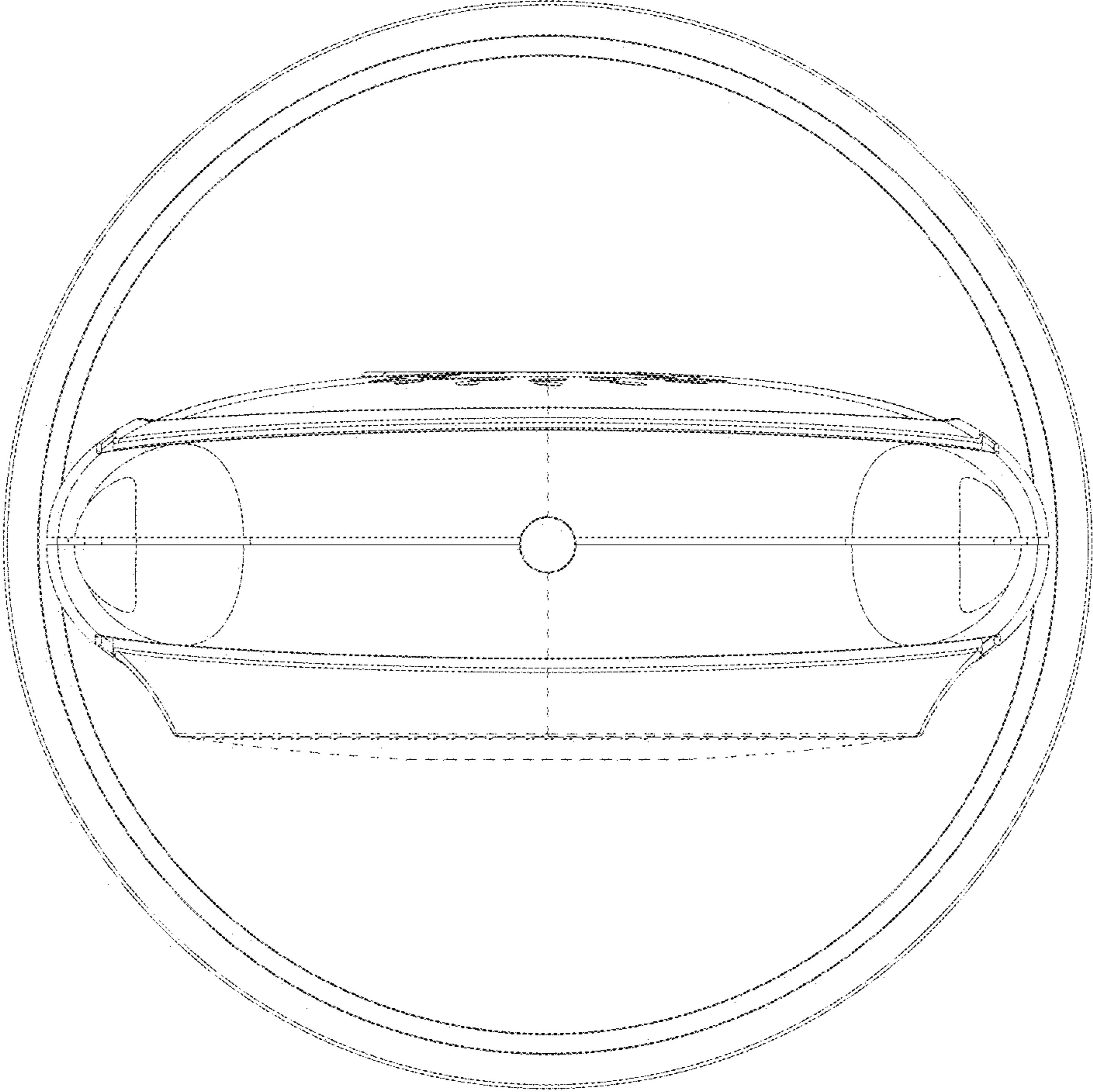

FIG. 6



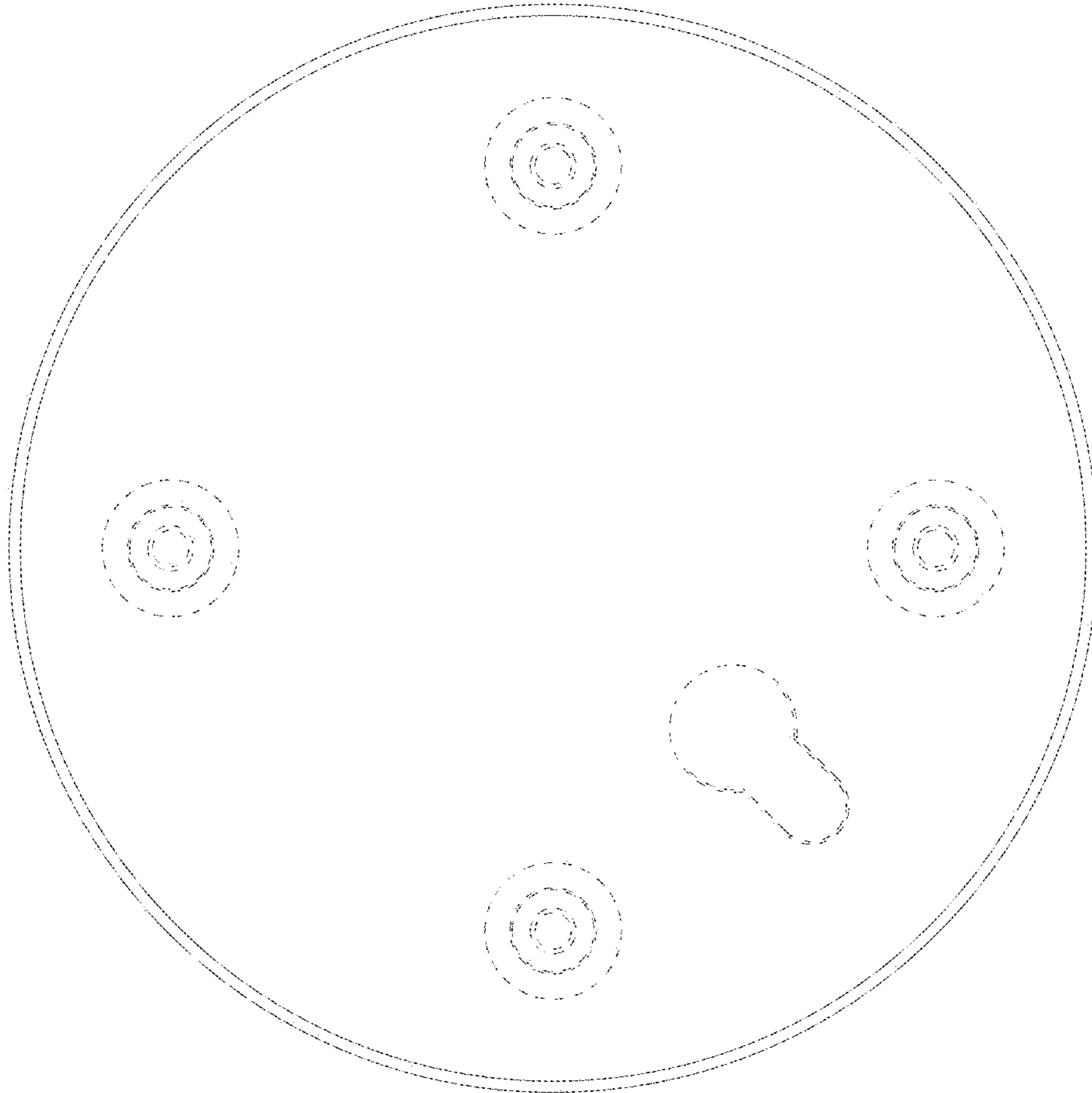

FIG. 7