

US00D966353S

(12) **United States Design Patent** (10) **Patent No.:** **US D966,353 S**
Tang (45) **Date of Patent:** **** Oct. 11, 2022**

(54) **ICE CUBE TRAY**

(56) **References Cited**

(71) Applicant: **Shenzhen Taihe Tech Ltd**, Shenzhen (CN)

U.S. PATENT DOCUMENTS

(72) Inventor: **Hong Tang**, Shenzhen (CN)

D804,546 S	12/2017	Richardson	
D804,547 S	12/2017	Richardson	
D852,237 S	6/2019	Helton	
D852,854 S	* 7/2019	Helton	D15/90
D865,821 S	* 11/2019	Richardson	D15/90
D899,470 S	* 10/2020	Liu	D15/90
D908,747 S	* 1/2021	Zhao	D15/89
D915,475 S	* 4/2021	Wu	D15/90
D931,914 S	* 9/2021	Zhai	D15/90
D941,889 S	* 1/2022	Wu	D15/90

(**) Term: **15 Years**

(21) Appl. No.: **29/777,709**

(22) Filed: **Apr. 8, 2021**

(51) **LOC (13) Cl.** **15-07**

* cited by examiner

(52) **U.S. Cl.**

Primary Examiner — Khawaja Anwar

USPC **D15/89**

(57) **CLAIM**

(58) **Field of Classification Search**

The ornamental design for an ice cube tray, as shown and described.

USPC D15/79–91

CPC .. F25D 11/00; F25D 17/065; F25D 2325/022;

F25D 23/069; F25D 25/025; F25D 11/02;

F25D 17/062; F25D 21/12; F25D 21/125;

F25D 21/14; F25D 2317/061; F25D

2317/067; F25D 2323/021; F25D

2323/024; F25D 23/028; F25D 23/04;

F25D 23/066; F25D 23/085; F25D

23/087; F25D 23/126; F25D 2400/02;

F25D 2400/06; F25D 2400/361; F25D

2400/40; F25D 25/005; F25D 25/02;

F25D 2600/02; F25D 2700/02; F25D

2700/12; F25D 2700/121; F25D 2700/14;

F25D 29/00

DESCRIPTION

FIG. 1 is a perspective view of an ice cube tray showing my new design;

FIG. 2 is a top view thereof;

FIG. 3 is a left side view thereof;

FIG. 4 is a front view thereof;

FIG. 5 is a right side view thereof;

FIG. 6 is a back view thereof; and,

FIG. 7 is a bottom view thereof.

The broken lines shown in the drawings depict portions of the ice cube tray in which the design is embodied that form no part of the claimed design.

See application file for complete search history.

1 Claim, 7 Drawing Sheets

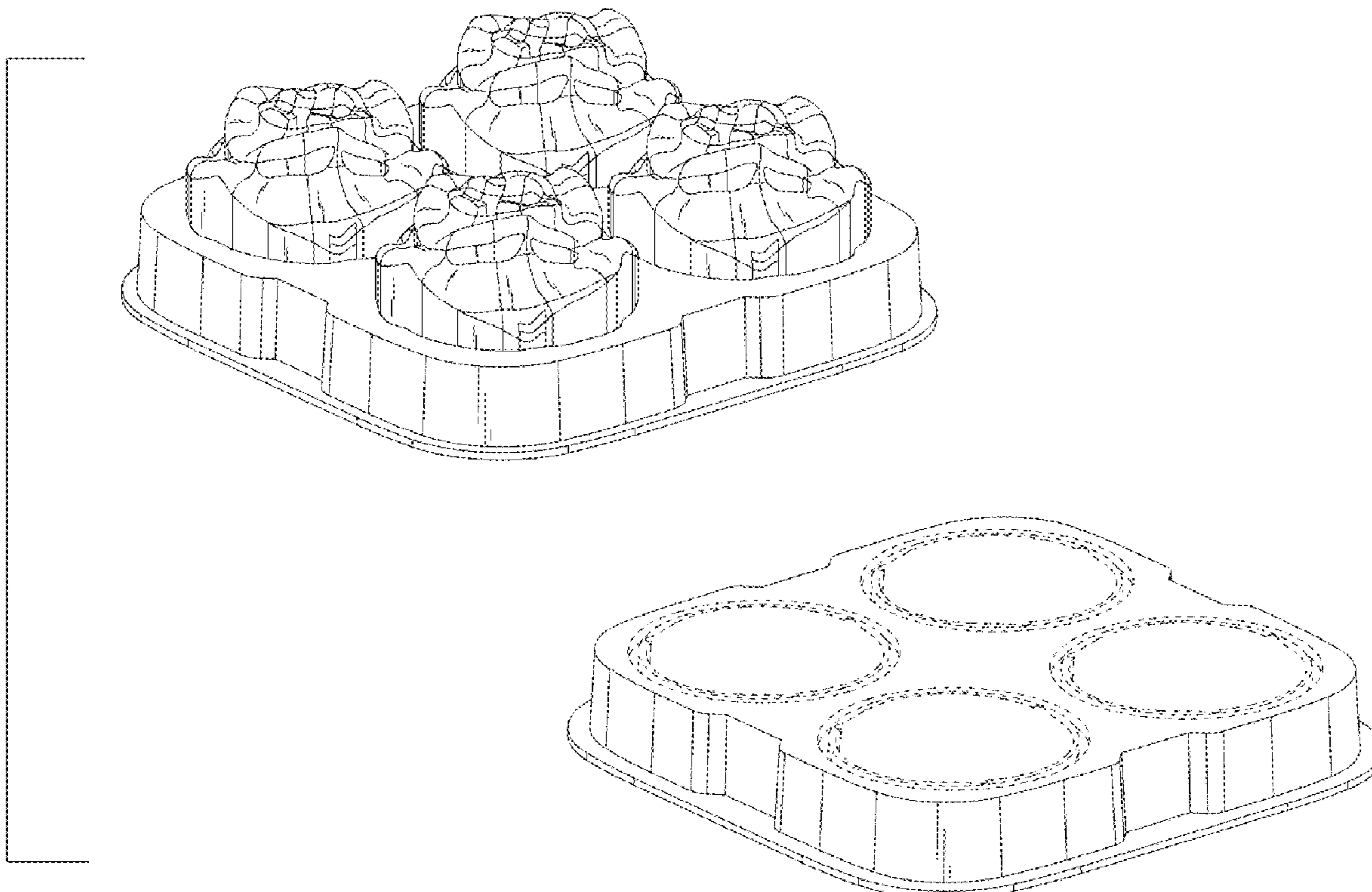

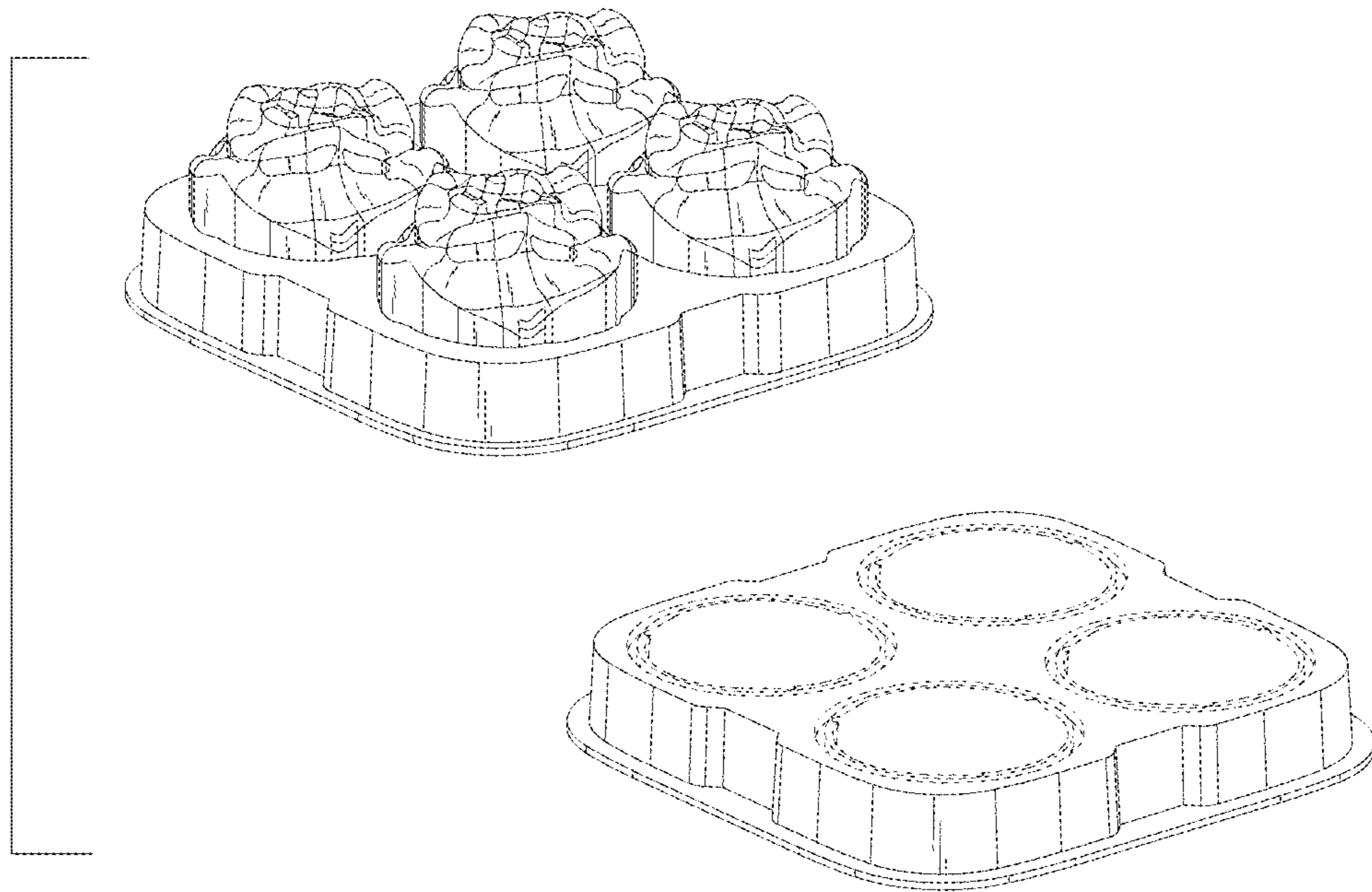

FIG. 1

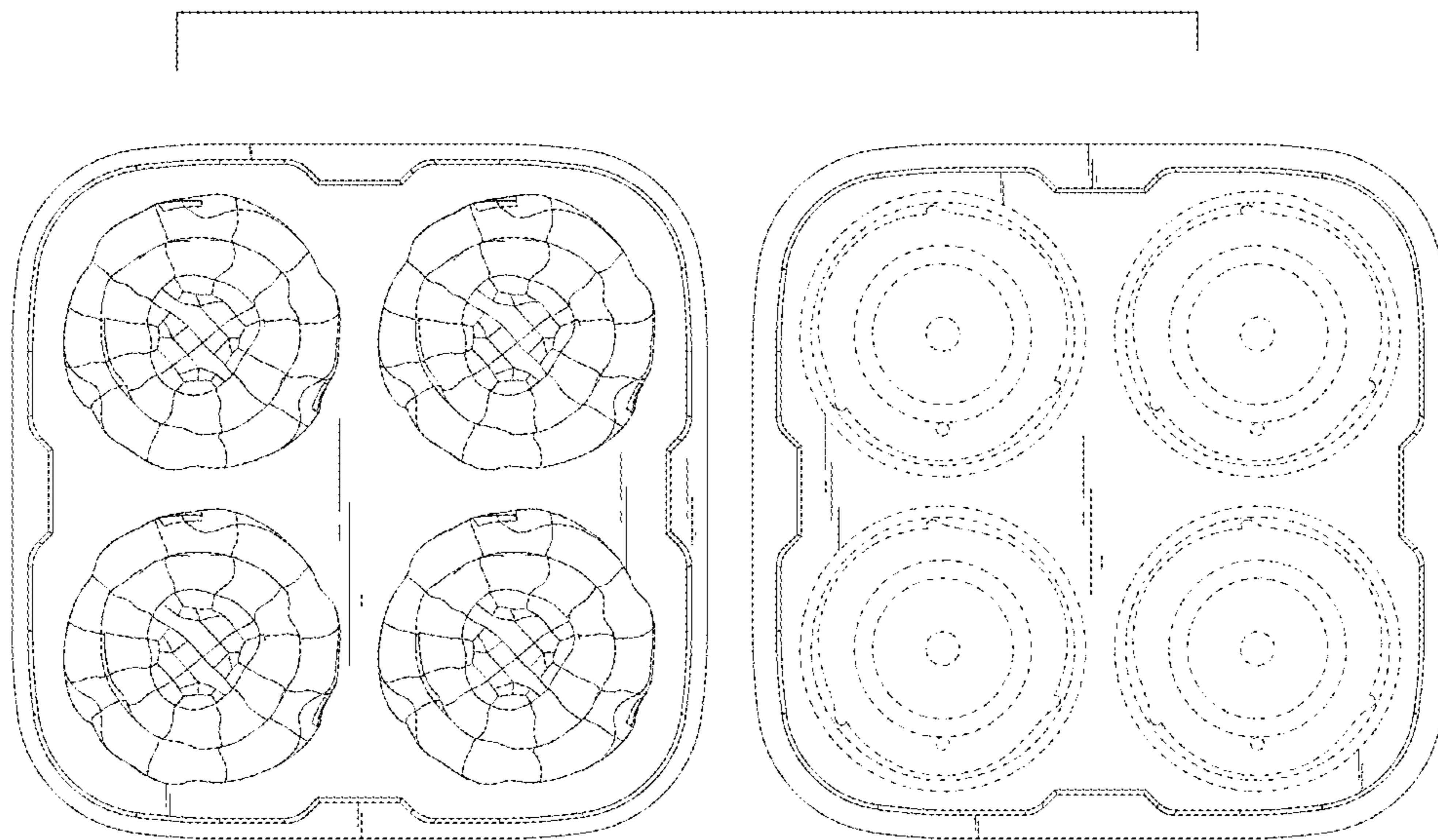

FIG. 2

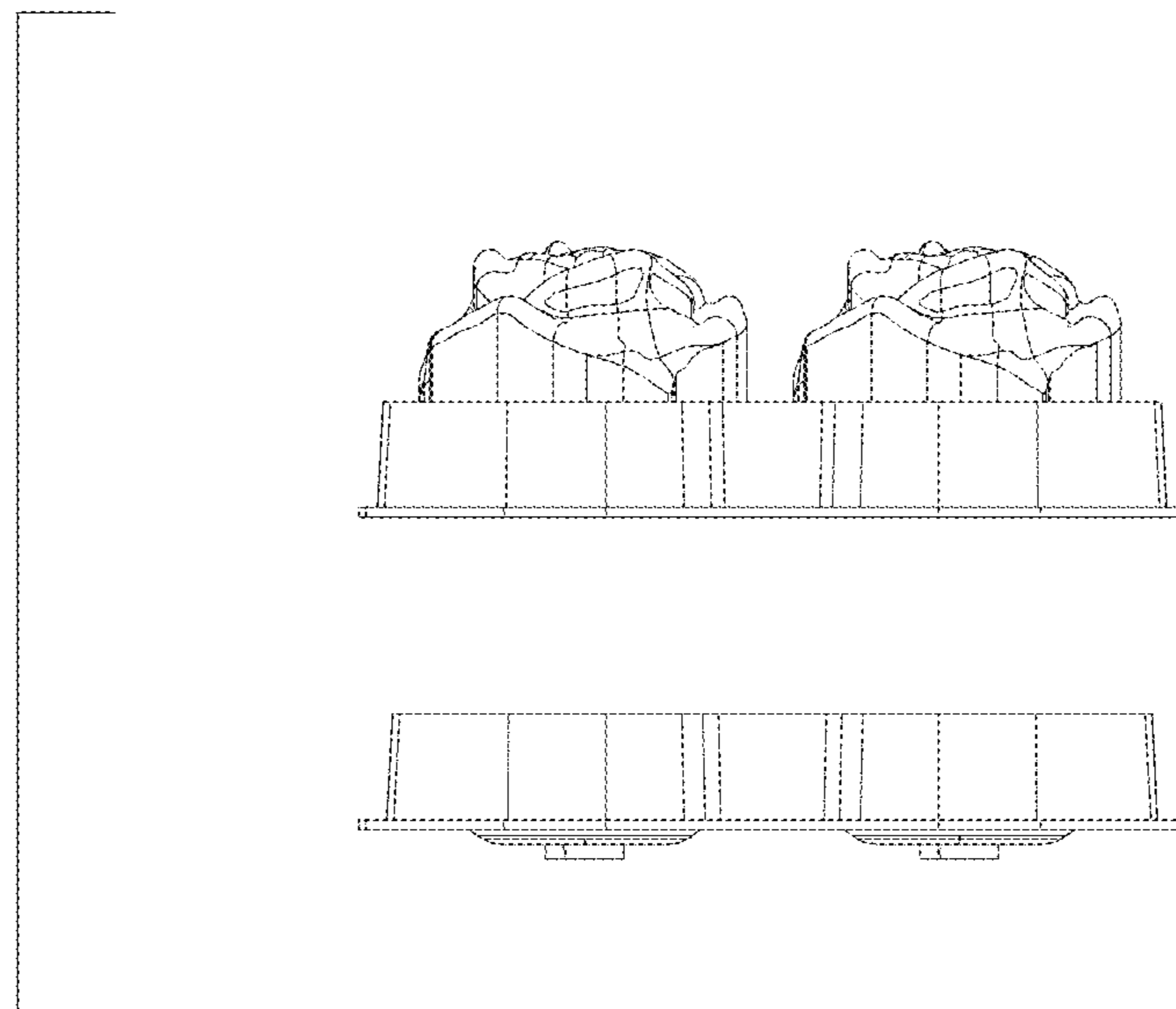

FIG.3

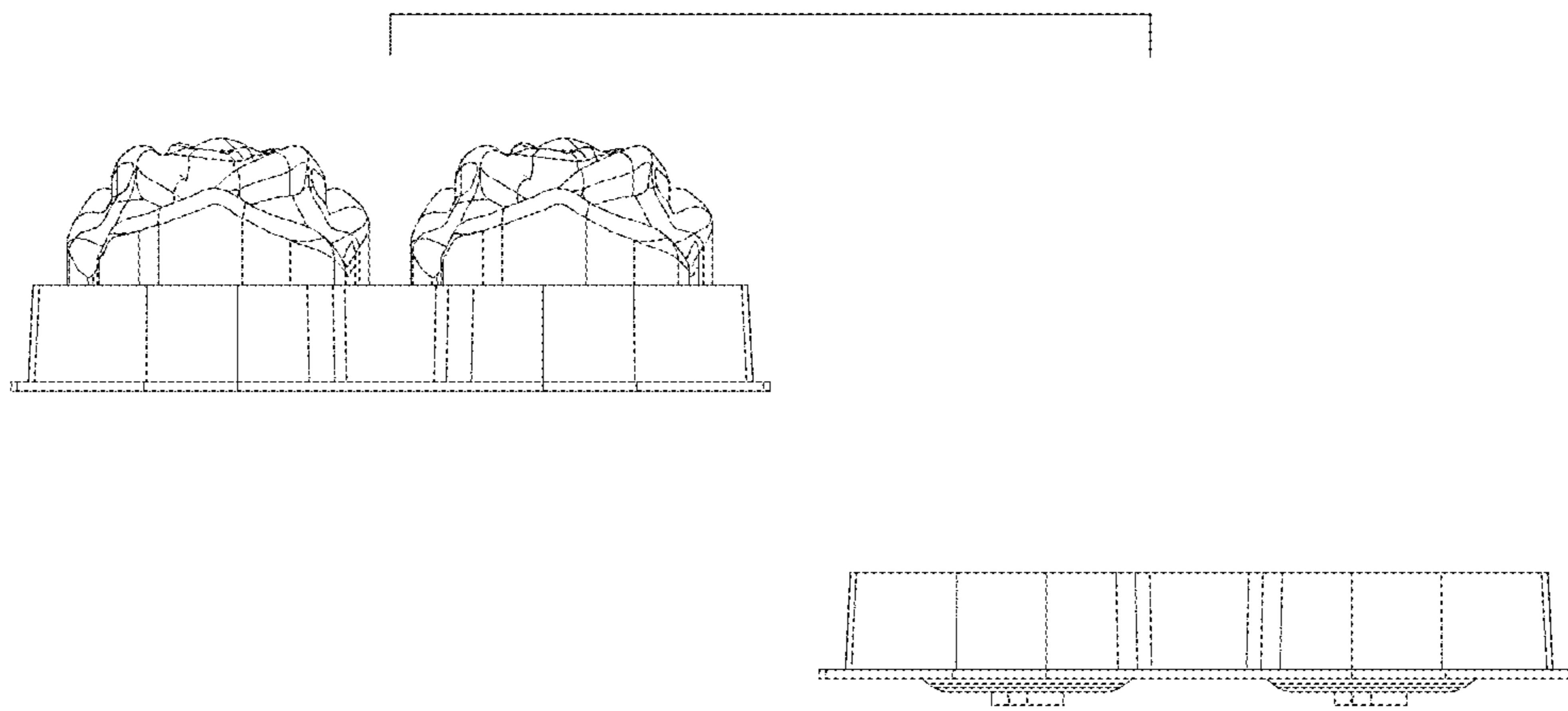

FIG. 4

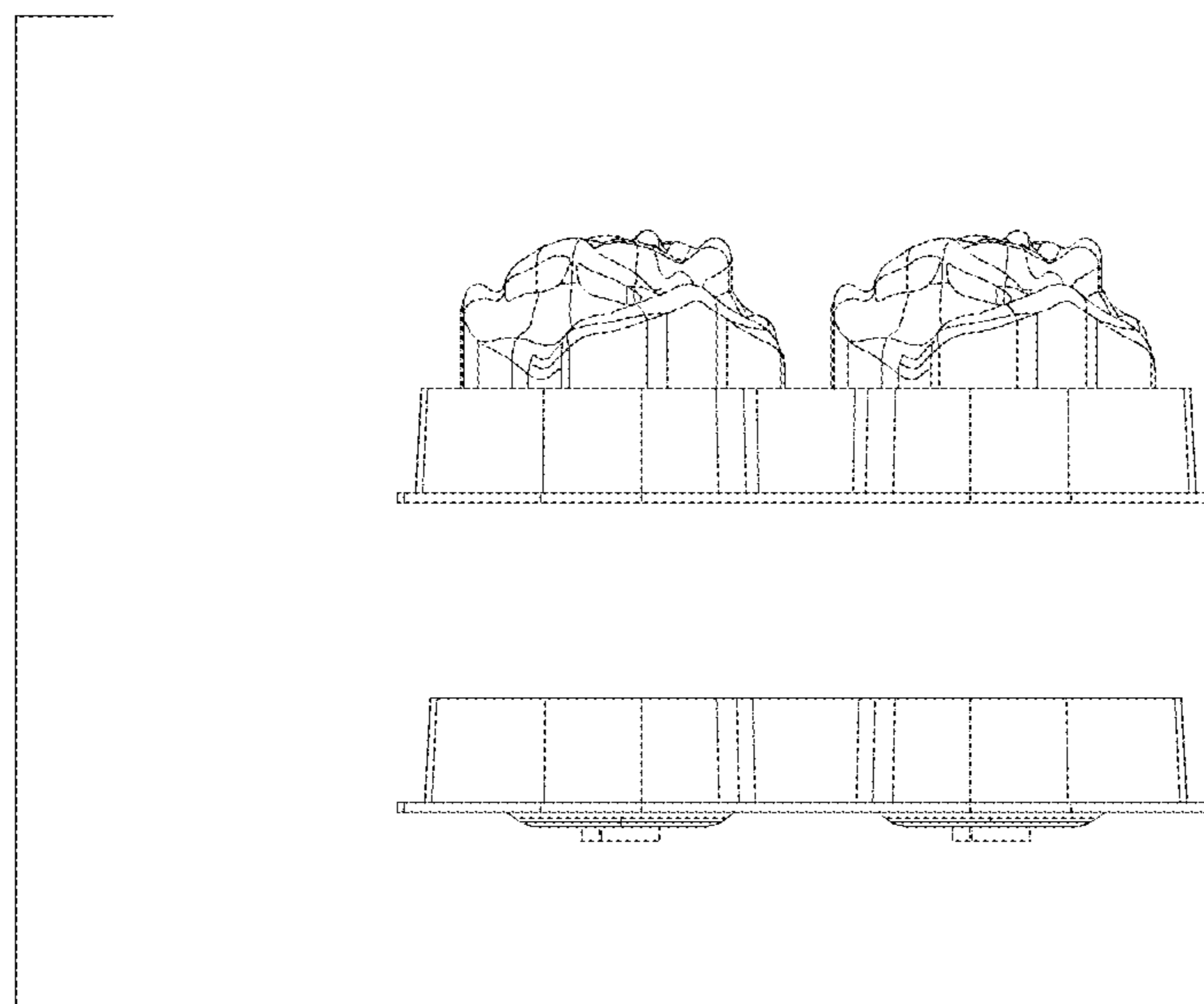

FIG.5

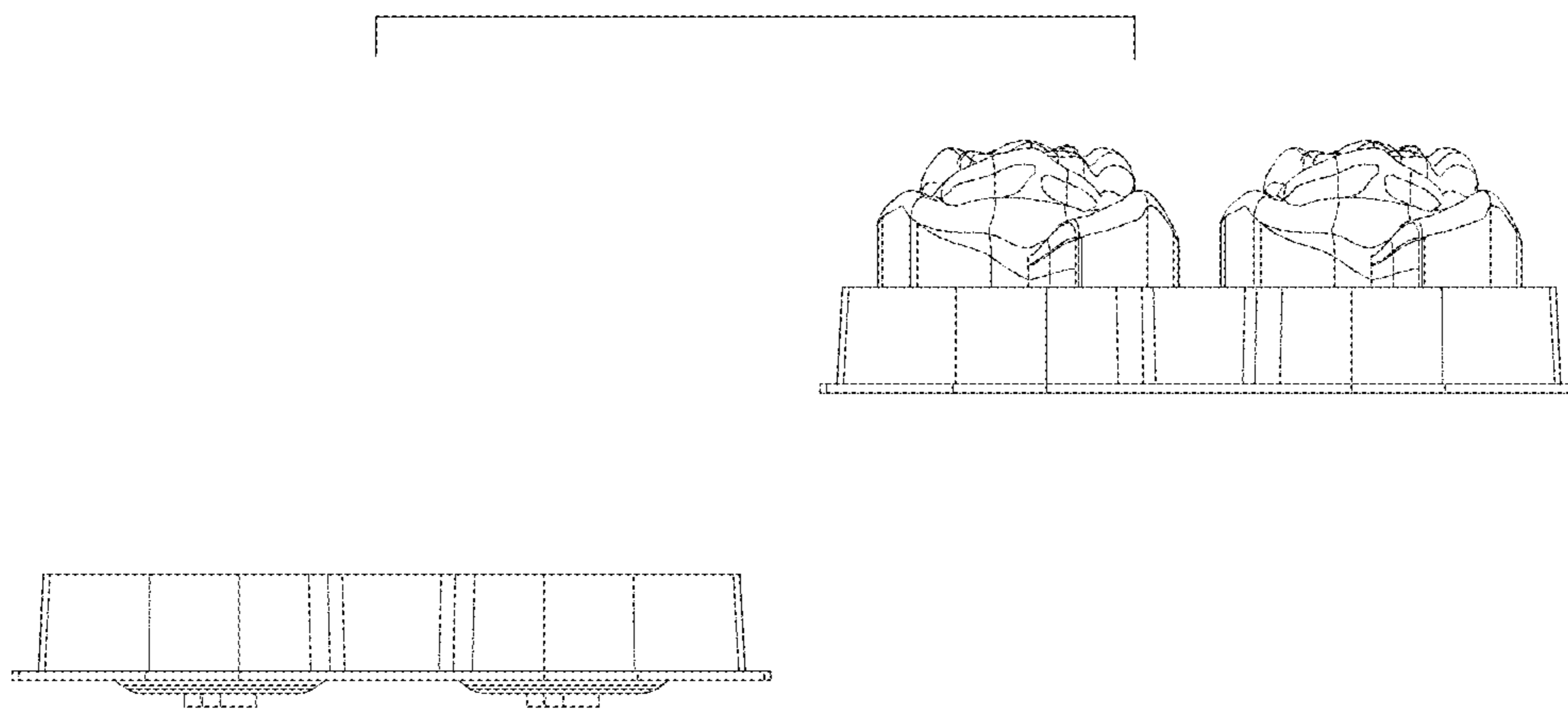

FIG.6

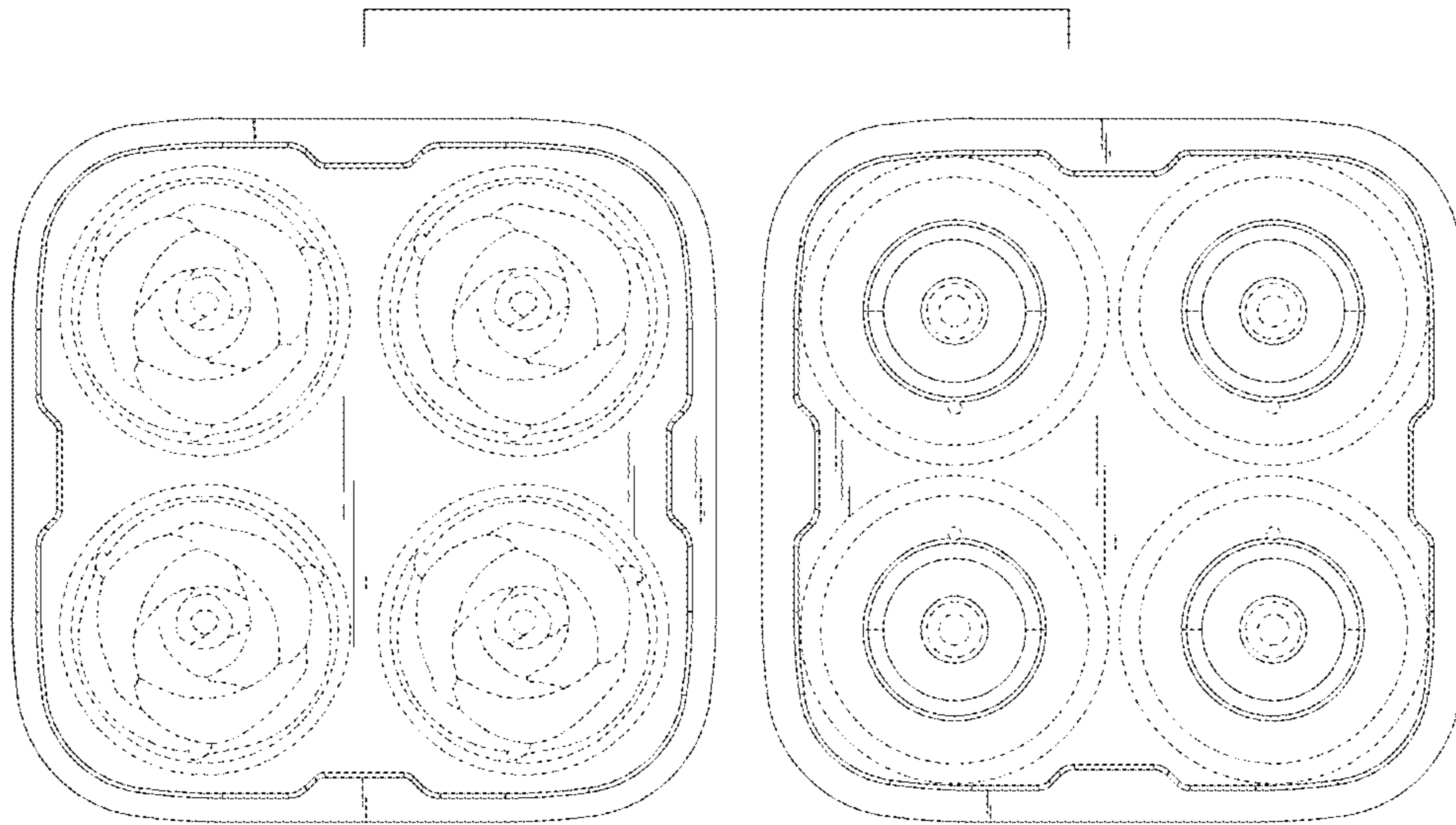

FIG. 7