



US00D966244S

(12) **United States Design Patent** (10) **Patent No.:** **US D966,244 S**
Lee et al. (45) **Date of Patent:** **** Oct. 11, 2022**

(54) **MOBILE PHONE**

D690,676 S * 10/2013 Daniel D14/138 AD
D766,891 S * 9/2016 Hong D14/341
D776,096 S * 1/2017 Kim D14/248

(71) Applicant: **LG ELECTRONICS INC.**, Seoul (KR)

(Continued)

(72) Inventors: **Jonghak Lee**, Seoul (KR); **Sojin Kim**, Seoul (KR); **Jinki Min**, Seoul (KR); **Hongkyu Park**, Seoul (KR); **Seunghyun Ji**, Seoul (KR)

FOREIGN PATENT DOCUMENTS

EM 008341408-0002 * 2/2021
EM 007009196-0017 * 10/2021

(Continued)

(73) Assignee: **LG ELECTRONICS INC.**, Seoul (KR)

OTHER PUBLICATIONS

(**) Term: **15 Years**

TCL's sliding-screen concept phone, CNET, youtube.com, dated Mar. 5, 2020, [online], [site visited Feb. 20, 2021]. Available from Internet, URL: <https://www.youtube.com/watch?v=-kl5H7NhNTg> (Year: 2020).*

(21) Appl. No.: **29/708,959**

(Continued)

(22) Filed: **Oct. 10, 2019**

(30) **Foreign Application Priority Data**

Primary Examiner — Jeffrey D Asch

Apr. 10, 2019 (JP) 2019-007916

(74) *Attorney, Agent, or Firm* — Birch, Stewart, Kolasch & Birch, LLP

(51) **LOC (13) Cl.** **14-03**

(57) **CLAIM**

(52) **U.S. Cl.**

The ornamental design for a mobile phone, as shown and described.

USPC **D14/248**

(58) **Field of Classification Search**

DESCRIPTION

USPC D14/138 AD, 138 R, 138 AA, 341, 345, D14/346, 203.1, 203.3, 203.4, 203.7, 248, D14/138 G, 132, 501, 336, 496; D21/517; D6/704; D16/241
CPC H04M 1/0237; H04M 1/206; H04M 1/208; H04M 1/0241; H04M 1/0268; G06F 1/1652; G06F 1/1624
See application file for complete search history.

FIG. 1 is a front perspective view of the mobile phone showing our new design;
FIG. 2 is a front view thereof;
FIG. 3 is a rear view thereof;
FIG. 4 is a left side view thereof;
FIG. 5 is a right side view thereof;
FIG. 6 is a top plan view thereof;
FIG. 7 is a bottom plan view thereof; and,
FIG. 8 is a rear perspective view thereof.

(56) **References Cited**

The broken lines depict portions of the mobile phone that form no part of the claimed design. The dash-dot broken lines define the bounds of the claimed design and form no part thereof.

U.S. PATENT DOCUMENTS

D526,636 S * 8/2006 Kim D14/138 AD
D536,684 S * 2/2007 Kim D14/138 AD
D551,647 S * 9/2007 Kim D14/138 AD
D554,119 S * 10/2007 Otsuka D14/480.5

1 Claim, 8 Drawing Sheets

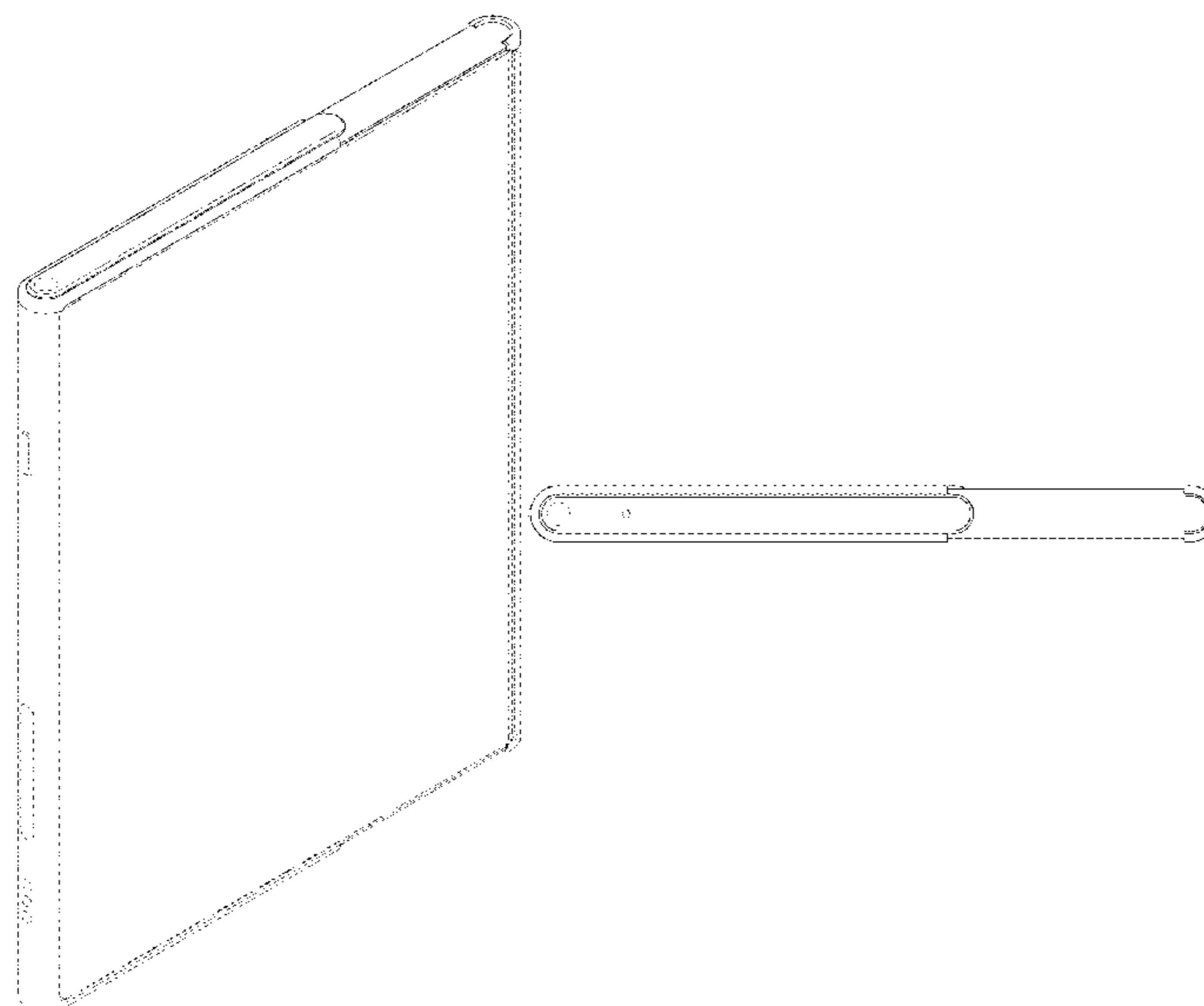

(56)

References Cited

FOREIGN PATENT DOCUMENTS

U.S. PATENT DOCUMENTS

10,553,135	B2 *	2/2020	Lee	G06F 3/147
D898,714	S *	10/2020	Fan	D14/248
10,880,417	B1 *	12/2020	Song	H04M 1/0237
10,936,017	B1 *	3/2021	Choi	G06F 1/1643
10,963,014	B1 *	3/2021	Park	H04B 1/3827
D923,598	S *	6/2021	Lee	H04M 1/0268 D14/138 AD
11,051,413	B2 *	6/2021	Yang	G06F 1/1626
D924,218	S *	7/2021	Son	D14/248
11,057,514	B1 *	7/2021	Noh	G06F 3/0488
D926,718	S *	8/2021	Lee	G06F 1/1624 D14/138 AD
D936,625	S *	11/2021	Lee	D14/138 AD
D936,626	S *	11/2021	Lee	D14/138 AD
D936,627	S *	11/2021	Lee	D14/138 AD
D940,680	S *	1/2022	Lee	D14/138 AD
2008/0125171	A1 *	5/2008	Shin	H04M 1/03 455/556.1
2009/0156264	A1 *	6/2009	Cho	G06F 1/1686 455/566
2014/0190844	A1 *	7/2014	Hsieh	G06F 1/1628 206/45.23
2019/0253541	A1 *	8/2019	Fan	H04M 1/0264
2019/0253543	A1 *	8/2019	Fan	H04M 1/0237
2020/0348727	A1 *	11/2020	Lee	G06F 1/1626
2020/0363841	A1 *	11/2020	Kim	G06F 1/1624
2021/0044683	A1 *	2/2021	He	G06F 1/1624
2021/0185835	A1 *	6/2021	Song	H05K 5/0017
2021/0278886	A1 *	9/2021	Kim	G06F 1/206
2021/0306446	A1 *	9/2021	Choi	H04N 5/2253
2021/0320680	A1 *	10/2021	Kim	H04M 1/185
2021/0405703	A1 *	12/2021	Song	H04M 1/72454
2022/0044598	A1 *	2/2022	Shin	G09F 9/301

KR	300968522.0000	*	8/2019
WO	D202678-002	*	12/2019

OTHER PUBLICATIONS

LG's Rollable Phone is becoming a Reality!, TechAvid youtube.com, dated Dec. 2, 2020, [online], [site visited Feb. 20, 2021]. Available from Internet, URL: <https://www.youtube.com/watch?v=tZK6a4-GunE> (Year: 2020).*

LG Rollable Phone Versus TCL Rollable Phone; Who Won CES 2021?, by Kelvin, Jan. 14, 2021, Concept Phones, [online], [site visited Feb. 20, 2021]. Available from Internet, URL: <https://www.concept-phones.com/lg/lg-rollable-phone-versus-tcl-rollable-phone-who-won-ces-2021/> (Year: 2021).*

Rollable display smartphones are coming Next!, GadgetMatch, youtube.com, dated Mar. 5, 2020, [online], [site visited Feb. 20, 2021]. Available from Internet, URL: <https://www.youtube.com/watch?v=uzExejMsVOY> (Year: 2020).*

Top 5 Rollable Phones with Sliding screens 2021 | Rollable Smartphones | Rolling Display Phones, Top 5 Gadgets, youtube.com, dated Nov. 25, 2020, [online], [site visited Feb. 20, 2021]. Available from Internet, URL: <https://www.youtube.com/watch?v=ZjofT-71k8U> (Year: 2020).*

Oppo X 2021 Rollable Concept Phone Truly Looks Like the Next Big Thing, by Kelvin, Nov. 18, 2020, Concept Phones, [online], [site visited Feb. 20, 2021]. Available from Internet, URL: <https://www.concept-phones.com/news/oppo-x-2021-rollable-concept-phone-truly-looks-like-the-next-big-thing/> (Year: 2020).*

Oppo Rollable Display Phone Hands-on Experience, Creator Studio, youtube.com, dated Nov. 17, 2020, [online], [site visited Feb. 20, 2021]. Available from Internet, URL: <https://www.youtube.com/watch?v=CUTmYqJcVpQ> (Year: 2020).*

U.S. Appl. No. 29/708,962, filed Oct. 10, 2019.

U.S. Appl. No. 29/708,933, filed Oct. 10, 2019.

* cited by examiner

FIG. 1

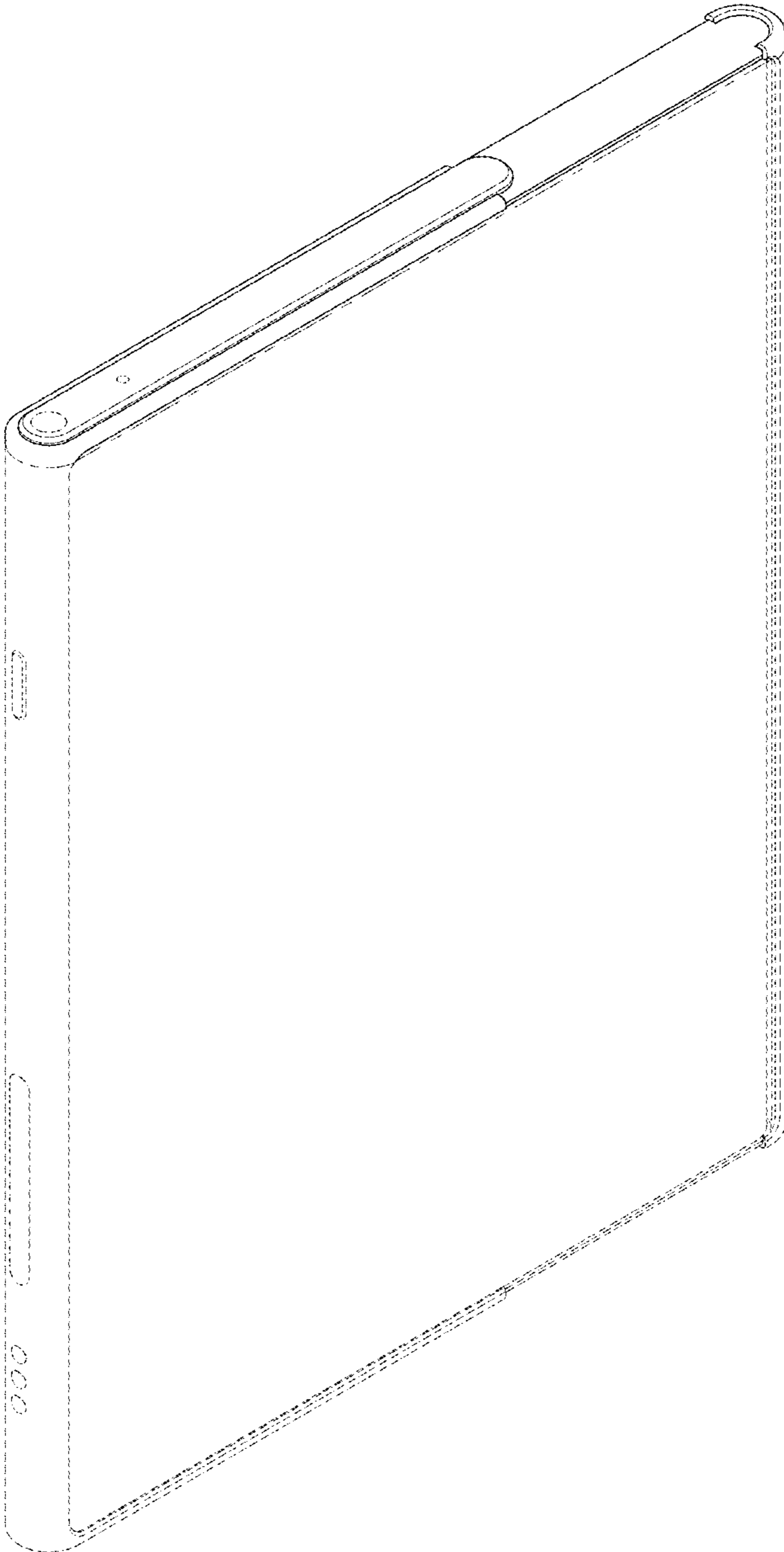

FIG. 2

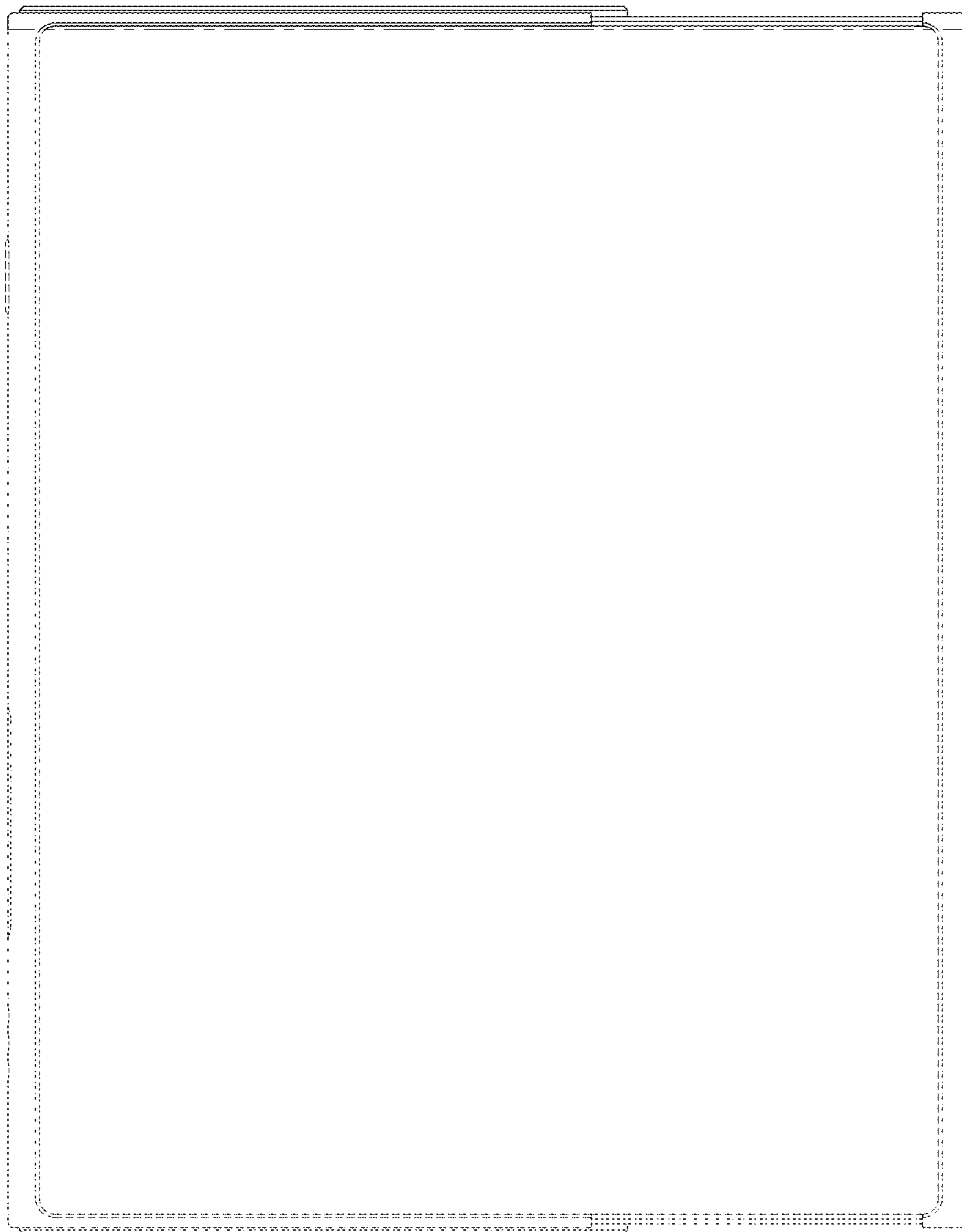

FIG. 3

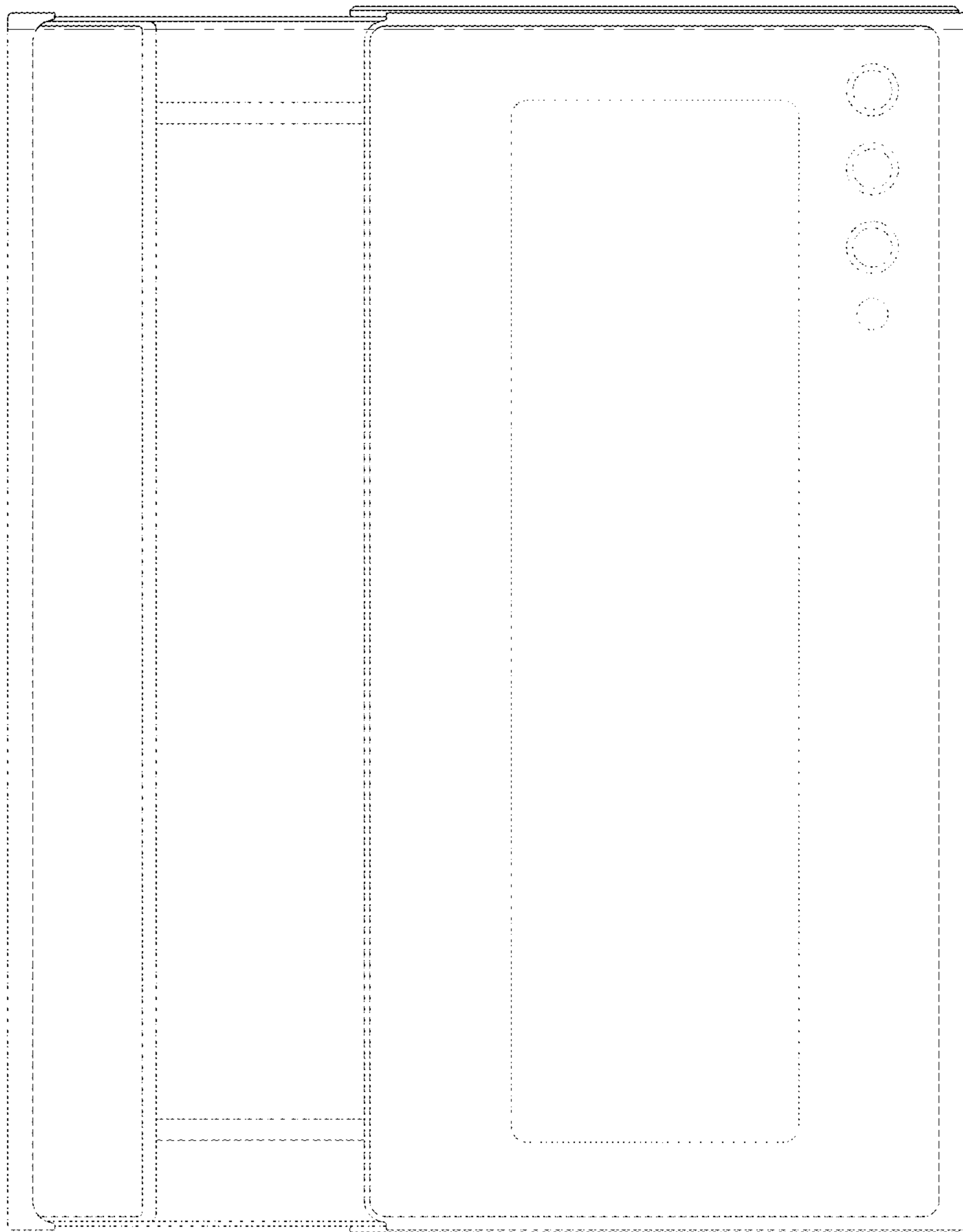

FIG. 4

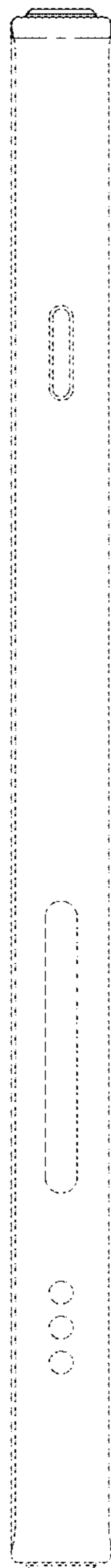

FIG. 5

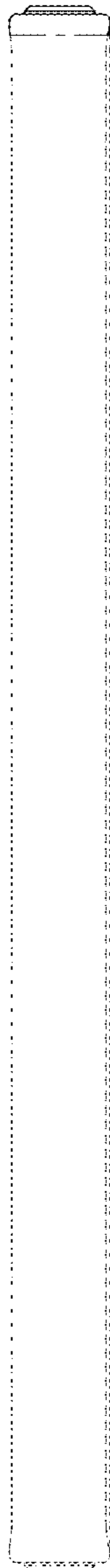

FIG. 6

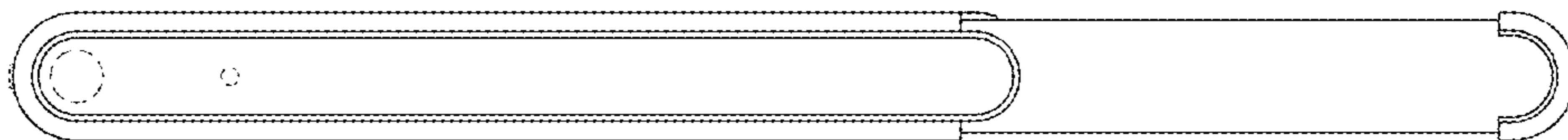

FIG. 7

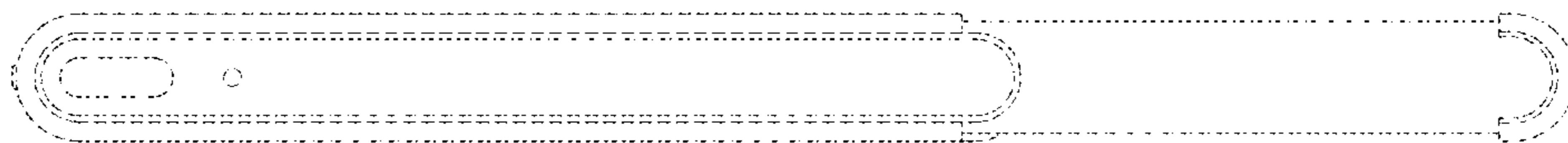

FIG. 8

