



US00D966202S

(12) **United States Design Patent** (10) **Patent No.:** **US D966,202 S**
Willson (45) **Date of Patent:** **** Oct. 11, 2022**

(54) **SAFETY PLUG**

(71) Applicant: **Walmart Apollo, LLC**, Bentonville, AR (US)
(72) Inventor: **Adrian Willson**, Fayetteville, AR (US)
(73) Assignee: **Walmart Apollo, LLC**, Bentonville, AR (US)
(**) Term: **15 Years**

(21) Appl. No.: **29/721,046**

(22) Filed: **Jan. 17, 2020**

(51) **LOC (13) Cl.** **13-03**

(52) **U.S. Cl.**
USPC **D13/154**

(58) **Field of Classification Search**
USPC D13/137.1, 137.2, 137.3, 137.4, 138.1, D13/138.2, 139.1, 139.2, 139.3, 139.4, D13/139.5, 139.6, 139.7, 139.8, 146, 153, D13/154, 199, 156, 133
CPC H01R 13/00; H01R 13/03; H01R 13/04; H01R 13/10; H01R 13/35; H01R 13/44; H01R 13/46; H01R 13/453; H01R 13/4534;

(Continued)

(56) **References Cited**

U.S. PATENT DOCUMENTS

D127,010 S * 5/1941 Judisch D13/137.1
D217,614 S * 5/1970 Kross
(Continued)

FOREIGN PATENT DOCUMENTS

CN 2288520 Y 8/1998
PH 3-2005-463-0001 * 1/1900

OTHER PUBLICATIONS

“NTONPOWER 2 Prong Power Strip with White Extension Cord 10 ft, 4 Outlet Surge Protector Power Strip with 4 USB Charging Ports for Laptop Home Office Desktop, 1700 J, Non Grounded Outlet Adapter”, first available Jul. 29, 2020. Amazon.com [https://www.amazon.com/dp/B08DTW721G] (Year: 2020).*

(Continued)

Primary Examiner — Rosemary K Tarcza
Assistant Examiner — Seth David Kumpf

(57) **CLAIM**

The ornamental design for a safety plug, as shown and described.

DESCRIPTION

FIG. 1 is a perspective view of a first embodiment of a safety plug in a connected state of the present invention; FIG. 2 is a perspective view of a first embodiment of a safety plug in a disconnected state of the present invention; FIG. 3 is a front view of a first embodiment thereof; FIG. 4 is a back view of a first embodiment thereof; FIG. 5 is a left side view of a first embodiment thereof; FIG. 6 is a right view of a first embodiment thereof; FIG. 7 is a top view of a first embodiment thereof; and FIG. 8 is a bottom view of a first embodiment thereof. FIG. 9 is a perspective view of a second embodiment of a safety plug in a connected state of the present invention; FIG. 10 is a perspective view of a second embodiment of a safety plug in a disconnected state of the present invention; FIG. 11 is a front view of a second embodiment thereof; FIG. 12 is a back view of a second embodiment thereof; FIG. 13 is a left side view of a second embodiment thereof; FIG. 14 is a right view of a second embodiment thereof; FIG. 15 is a top view of a second embodiment thereof; and, FIG. 16 is a bottom view of a second embodiment thereof. The broken lines are for illustrative purposes only and form no part of the claimed design.

1 Claim, 6 Drawing Sheets



(58) **Field of Classification Search**

CPC . H01R 13/502; H01R 13/506; H01R 13/514;
 H01R 13/518; H01R 13/6272; H01R
 13/631; H01R 13/639; H01R 13/652;
 H01R 13/665; H01R 13/6633; H01R
 13/6666; H01R 13/6675; H01R 13/7135;
 H01R 31/02; H01R 31/06; H01R 31/065;
 H01R 25/00; H01R 25/006; H01R 9/00;
 H01R 35/04; H01R 2201/06; H01H
 2207/00; H01H 2207/022; H01H
 2203/00; H05K 5/00; H05K 5/03; H02G
 3/088

See application file for complete search history.

(56)

References Cited

U.S. PATENT DOCUMENTS

D258,429	S	*	3/1981	Buckler	D13/138.1
D294,487	S	*	3/1988	Bannigan	D8/359
D295,622	S	*	5/1988	Good	D13/137.3
D305,326	S	*	1/1990	Clayton, Jr.	D13/138.1
D315,141	S	*	3/1991	Hames	D13/160
D367,262	S	*	2/1996	Lux	D13/137.3
D472,213	S	*	3/2003	Byrne	D13/139.4
D660,796	S	*	5/2012	Wen	D13/110
D666,158	S	*	8/2012	Auguste	D13/156
RE46,006	E	*	5/2016	Uekihara	D13/110
D817,886	S	*	5/2018	Yu	D13/138.2

OTHER PUBLICATIONS

“Power Strip, ALESTOR Surge Protector with 12 Outlets and 4 USB Ports, 6 Feet Extension Cord (1875W/15A), 2700 Joules, ETL Listed, Black . . .”, first available Nov. 26, 2020. Amazon.com [https://www.amazon.com/dp/B08P5LRY37] (Year: 2020).*

“HBN Outdoor Smart Plug, Wi-Fi Heavy Duty Outlet with 3 Independent Outlets, Compatible with Alexa and Google Assistant, IP44 Waterproof, Voice & Remote Control Outlet, No Hub Required, ETL Listed”, first available Dec. 31, 2019. Amazon.com [https://www.amazon.com/dp/B083C613X7] (Year: 2019).*

Topping, Will et al., Magnoplug—“Electricity mad: Smart, Simple and Safe”, Kickstarter, https://www.kickstarter.com/projects/magnoplug/magnoplug-the-electrical-plug-evolved, captured Feb. 4, 2020, pp. 1-16.

amazon.com, “Acouto 125cm / 49.2in Ignition Key Switch & Safety Lanyard for Johnson Evinrude Boat 5005801”, https://www.amazon.com/Acouto-Ignition-Lanyard-Johnson-Evinrude/dp/B07HMZPTQY, captured Feb. 4, 2020, 3 pages.

amazon.com, “Acouto Universal Engine Stop Kill Tether Switch Lanyard for ATV Racing Emergency”, https://www.amazon.com/Acouto-Universal-Engine-Lanyard-Emergency/dp/B07K67N45F?ref_ast_bbp_dp, captured Feb. 4, 2020, 1 page.

amazon.com, “Sea Dog 420488-1 Kill Switch with Lanyard”, https://www.amazon.com/Sea-Dog-420488-1-Switch-Lanyard/dp/B00DH3QHBI, captured Feb. 4, 2020, 1 page.

* cited by examiner

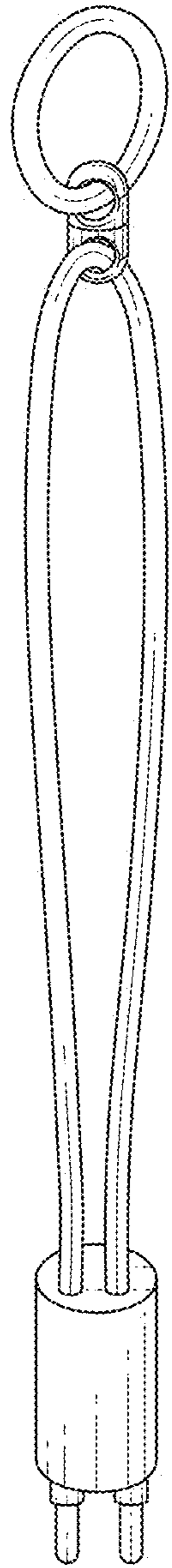

FIG. 1

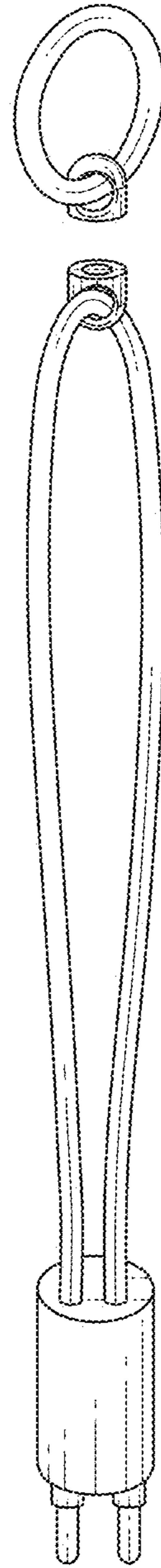

FIG. 2

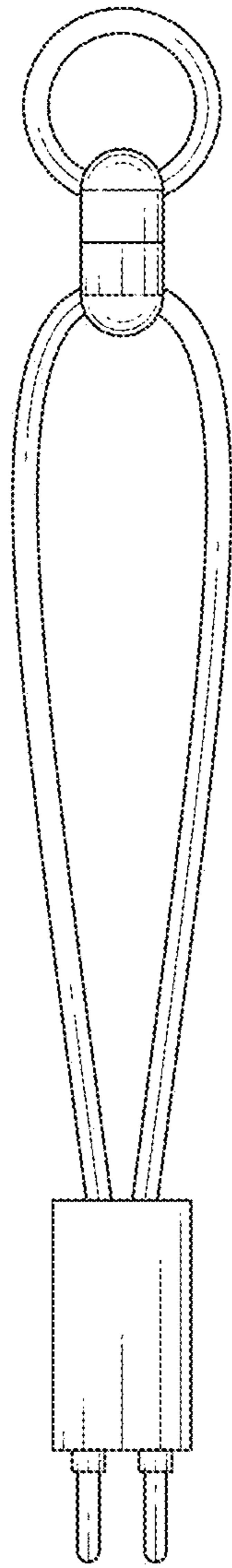

FIG. 3

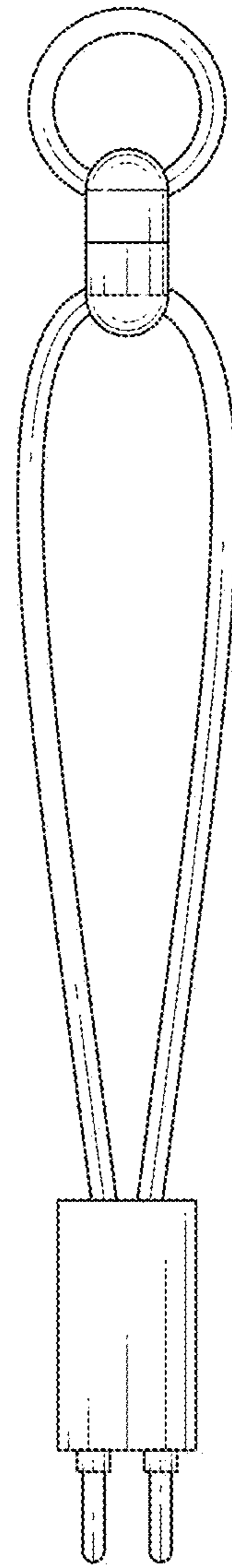

FIG. 4

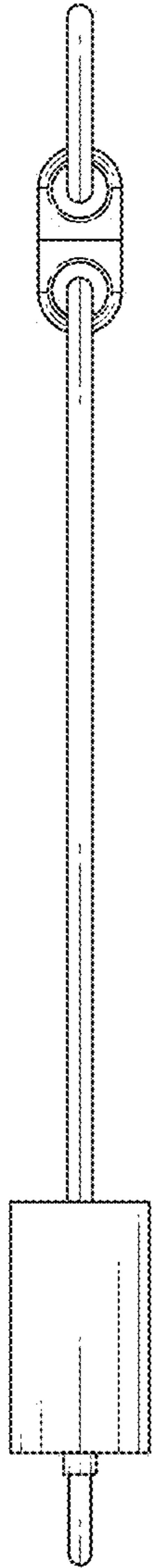

FIG. 5

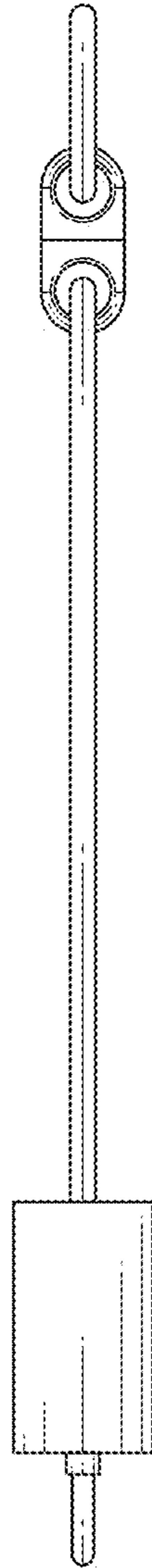

FIG. 6

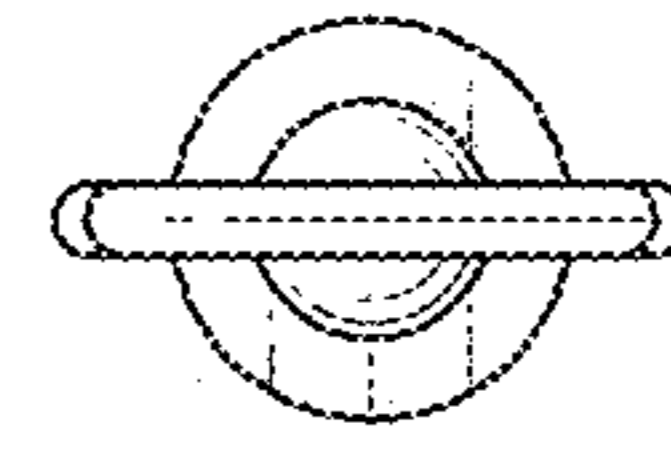

FIG. 7

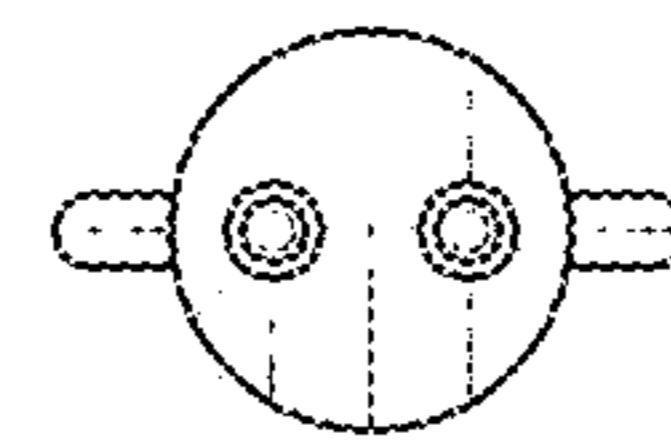

FIG. 8

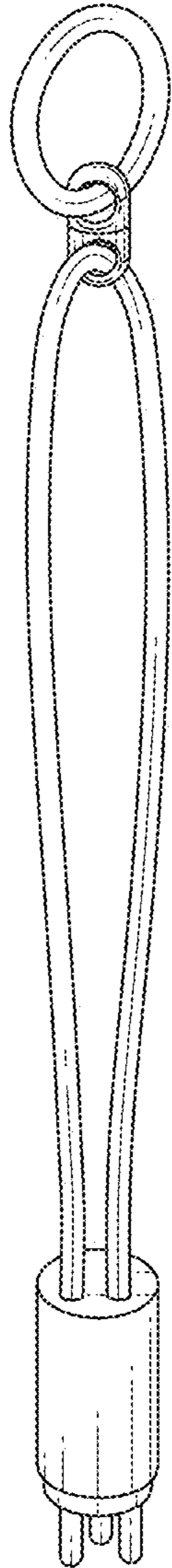

FIG. 9

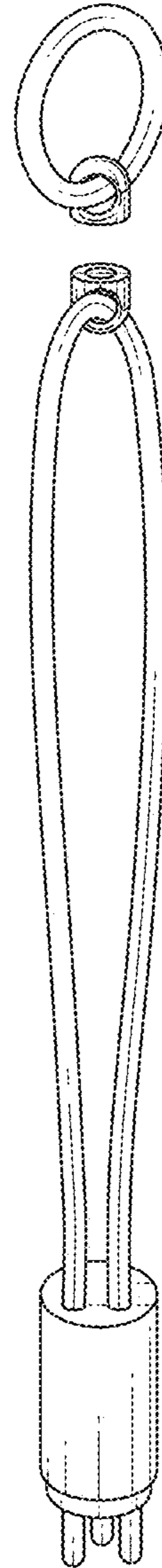

FIG. 10

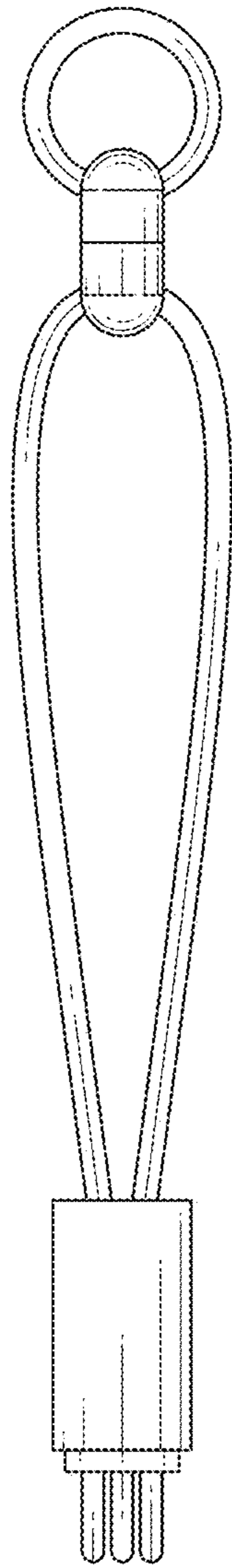

FIG. 11

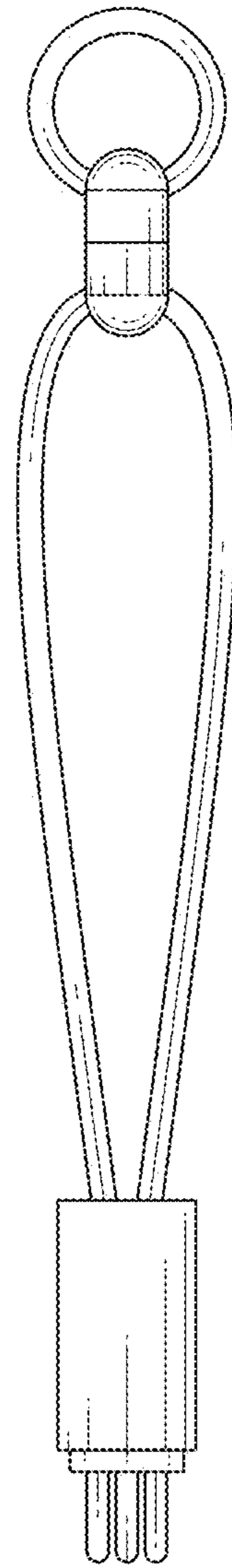

FIG. 12

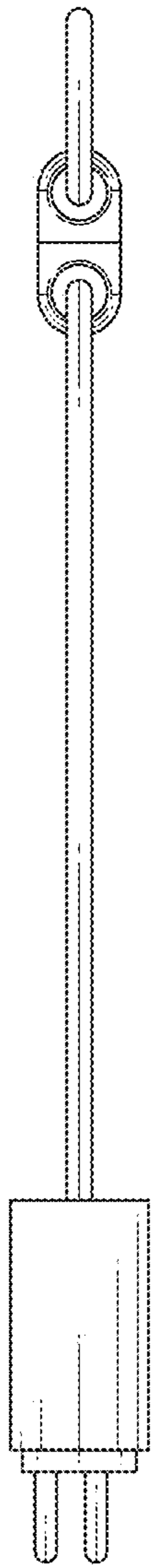

FIG. 13

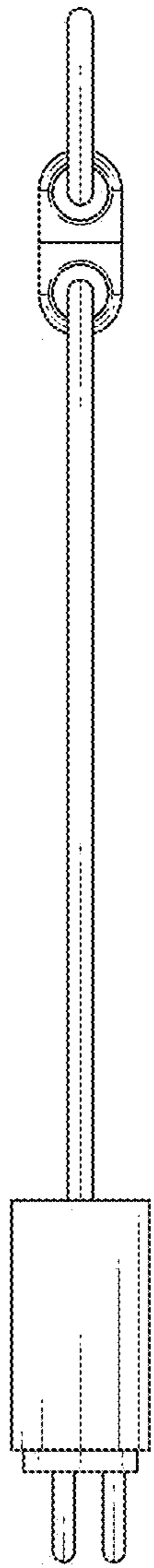

FIG. 14

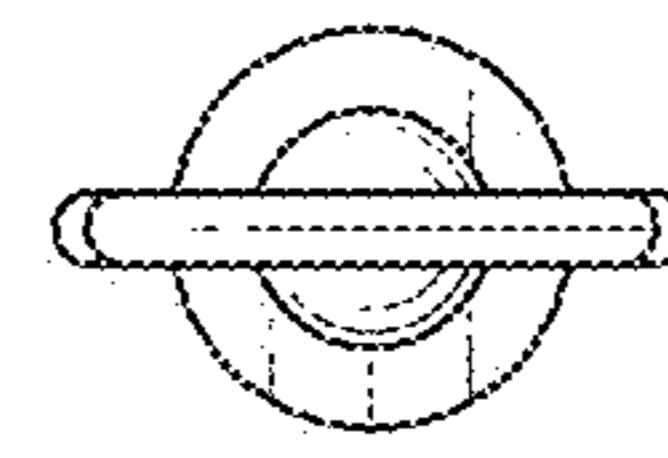

FIG. 15

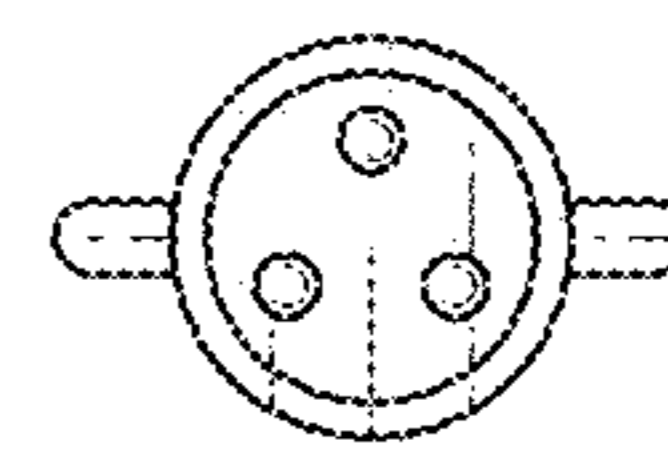

FIG. 16