



US00D966168S

(12) **United States Design Patent**
Rabenko

(10) **Patent No.:** **US D966,168 S**

(45) **Date of Patent:** **** Oct. 11, 2022**

(54) **SHIP**

(71) Applicant: **Lev Yosypovych Rabenko, Kyiv (UA)**

(72) Inventor: **Lev Yosypovych Rabenko, Kyiv (UA)**

(**) Term: **15 Years**

(21) Appl. No.: **35/512,565**

(22) Filed: **Aug. 31, 2021**

(80) **Hague Agreement Data**

Int. Filing Date: **Aug. 31, 2021**

Int. Reg. No.: **DM/216166**

Int. Reg. Date: **Aug. 31, 2021**

Int. Reg. Pub. Date: **Sep. 17, 2021**

(51) **LOC (13) Cl.** **12-06**

(52) **U.S. Cl.**

USPC **D12/315**

(58) **Field of Classification Search**

USPC D12/300, 301, 304, 315, 317, 318;
D21/542, 543

CPC B63B 1/00; B63B 1/04; B63B 1/06; B63B
1/08; B63B 1/10; B63B 1/38

See application file for complete search history.

(56) **References Cited**

U.S. PATENT DOCUMENTS

4,383,828 A * 5/1983 Wynne B63B 1/08

114/343

D290,949 S * 7/1987 Scarboro D12/315

D315,137 S *	3/1991	Runte	D12/318
D548,666 S *	8/2007	Laupman	D12/300
D553,071 S *	10/2007	de Rover	D12/315
D574,313 S *	8/2008	de Rover	D12/300
D587,641 S *	3/2009	Bouckaert	D12/300
D788,015 S *	5/2017	Lovo	D12/315
D818,418 S *	5/2018	Mattila	D12/300
D818,419 S *	5/2018	Mattila	D12/300
D826,832 S *	8/2018	Mattila	D12/300
D826,835 S *	8/2018	Mattila	D12/300

* cited by examiner

Primary Examiner — Darlington Ly

(57) **CLAIM**

The ornamental design for a ship, as shown and described.

DESCRIPTION

1. Ship

1.1 is a top, rear, and left side perspective view of a ship embodying my new design;

1.2 is a top, front, and right side perspective view thereof;

1.3 is a top plan view thereof;

1.4 is an enlarged partial top, rear, and left side perspective view thereof;

1.5 is a front elevation view thereof; and

1.6 is a rear elevation view thereof.

1 Claim, 6 Drawing Sheets

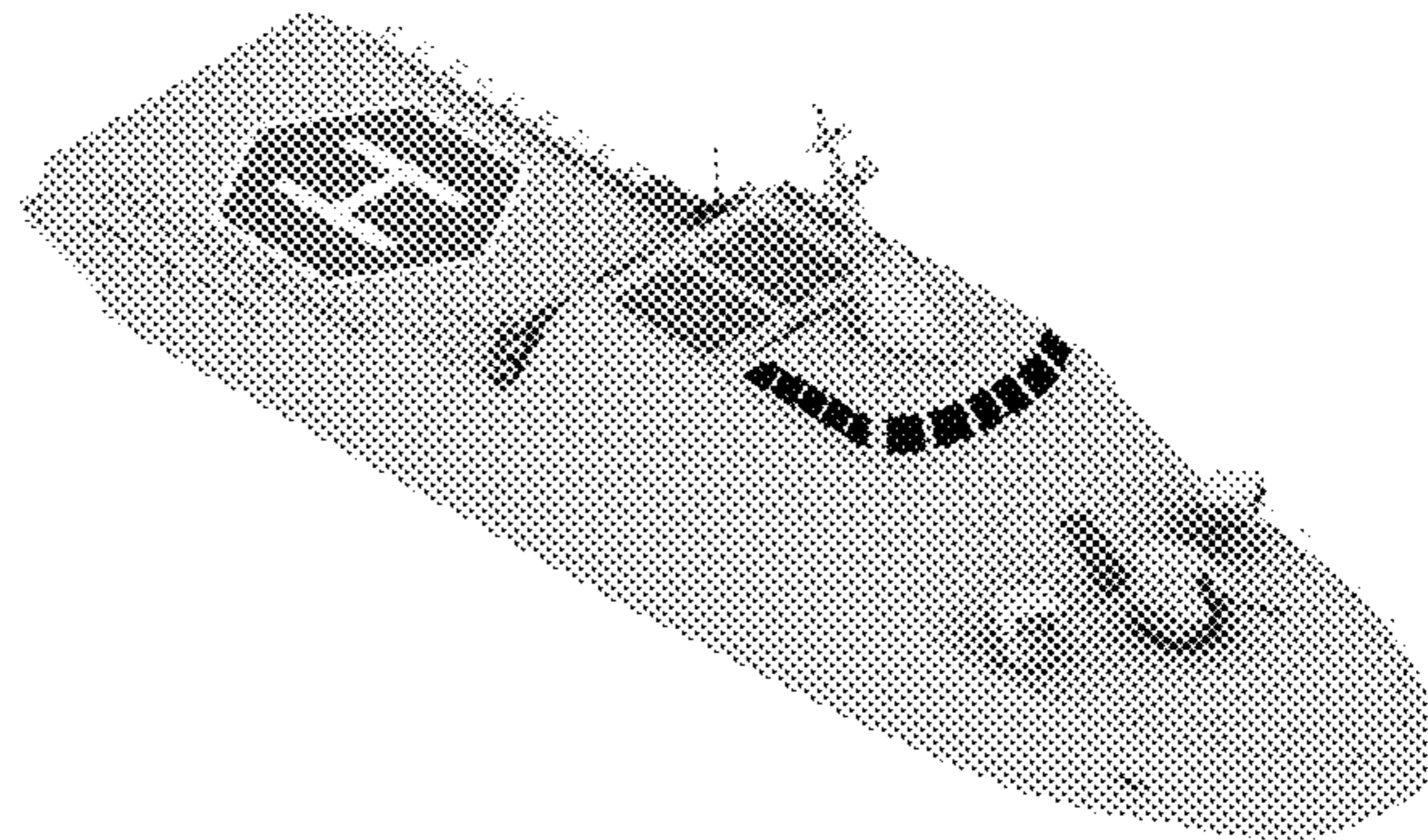
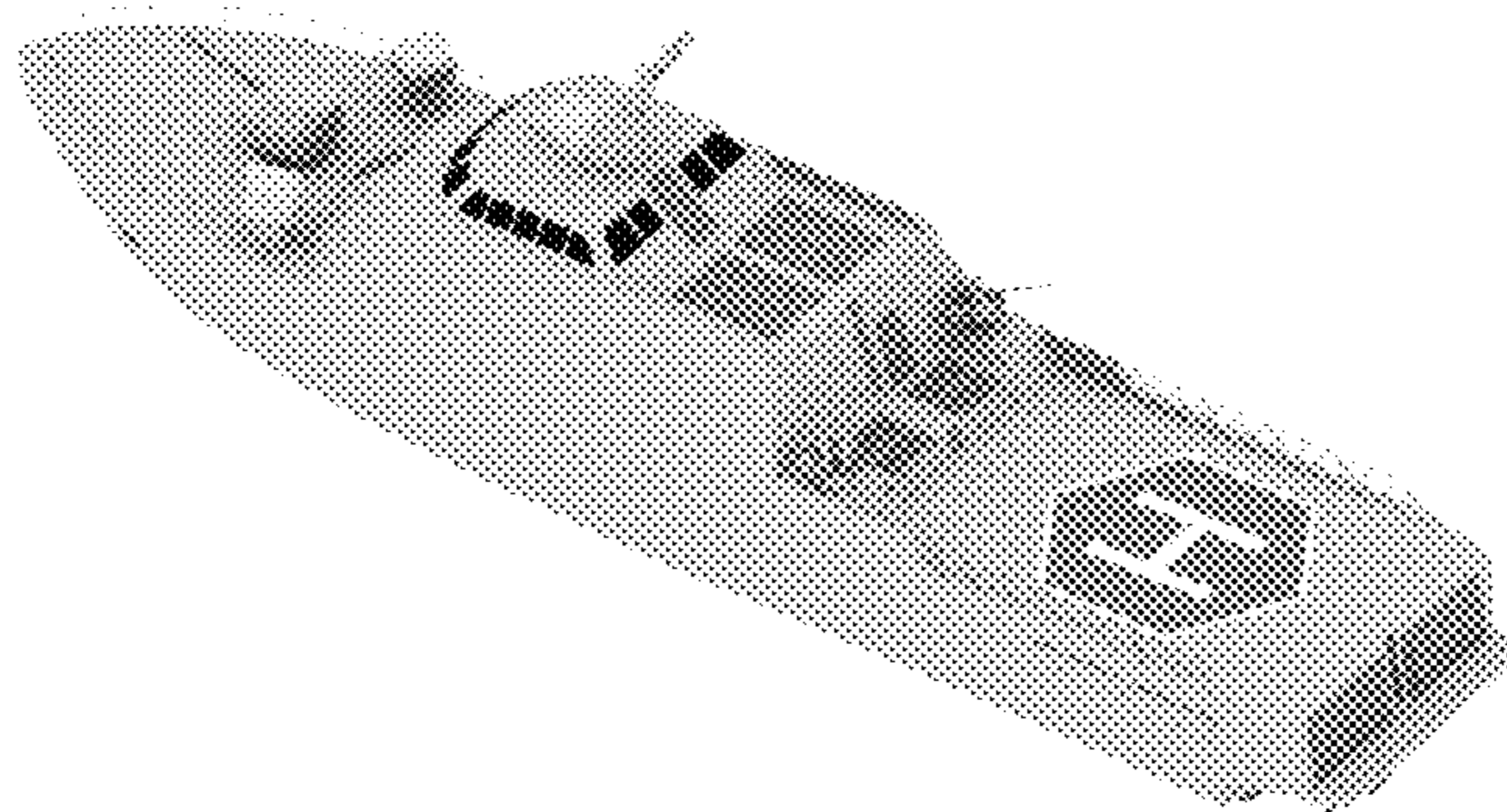

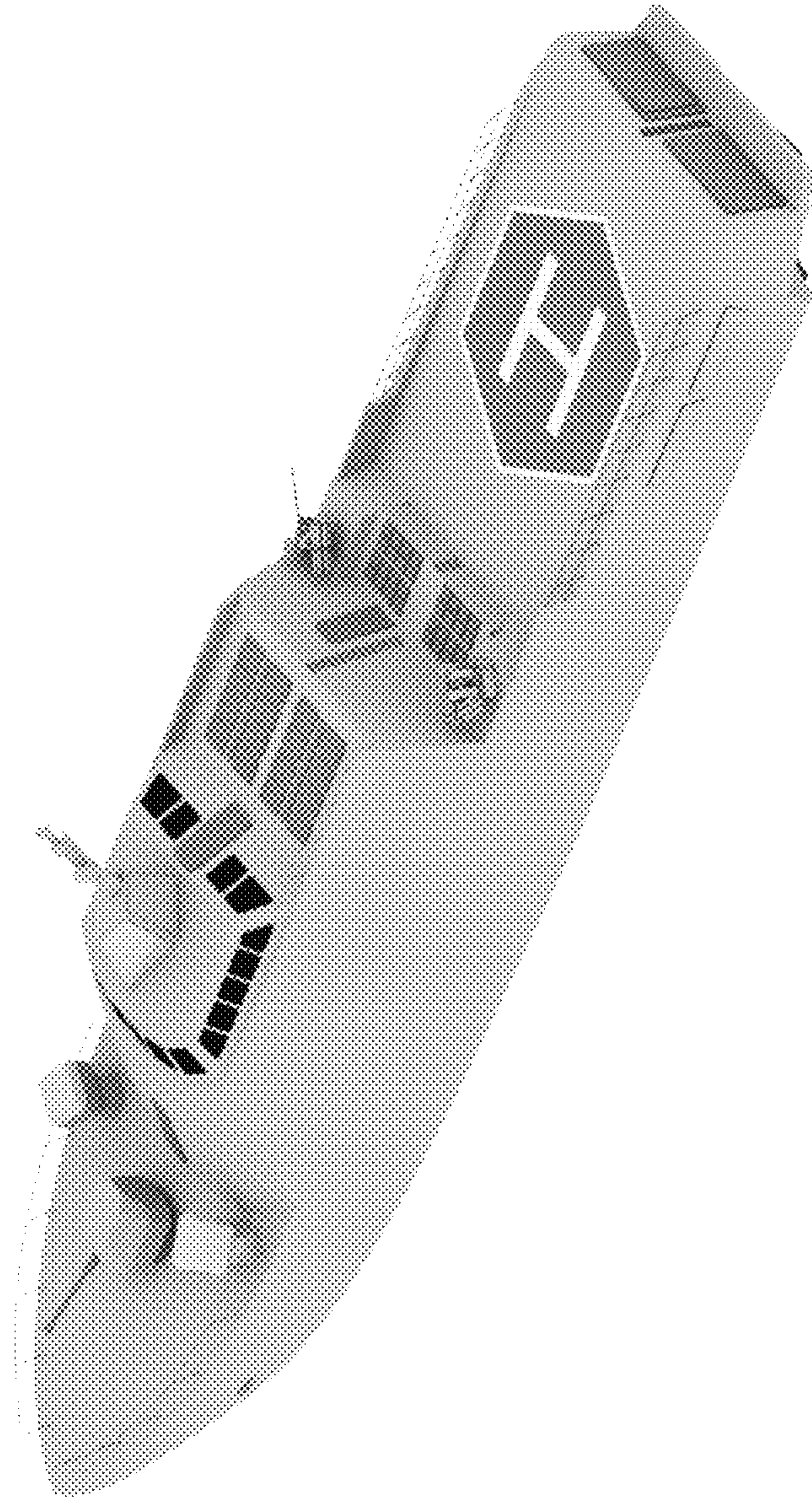

1.1

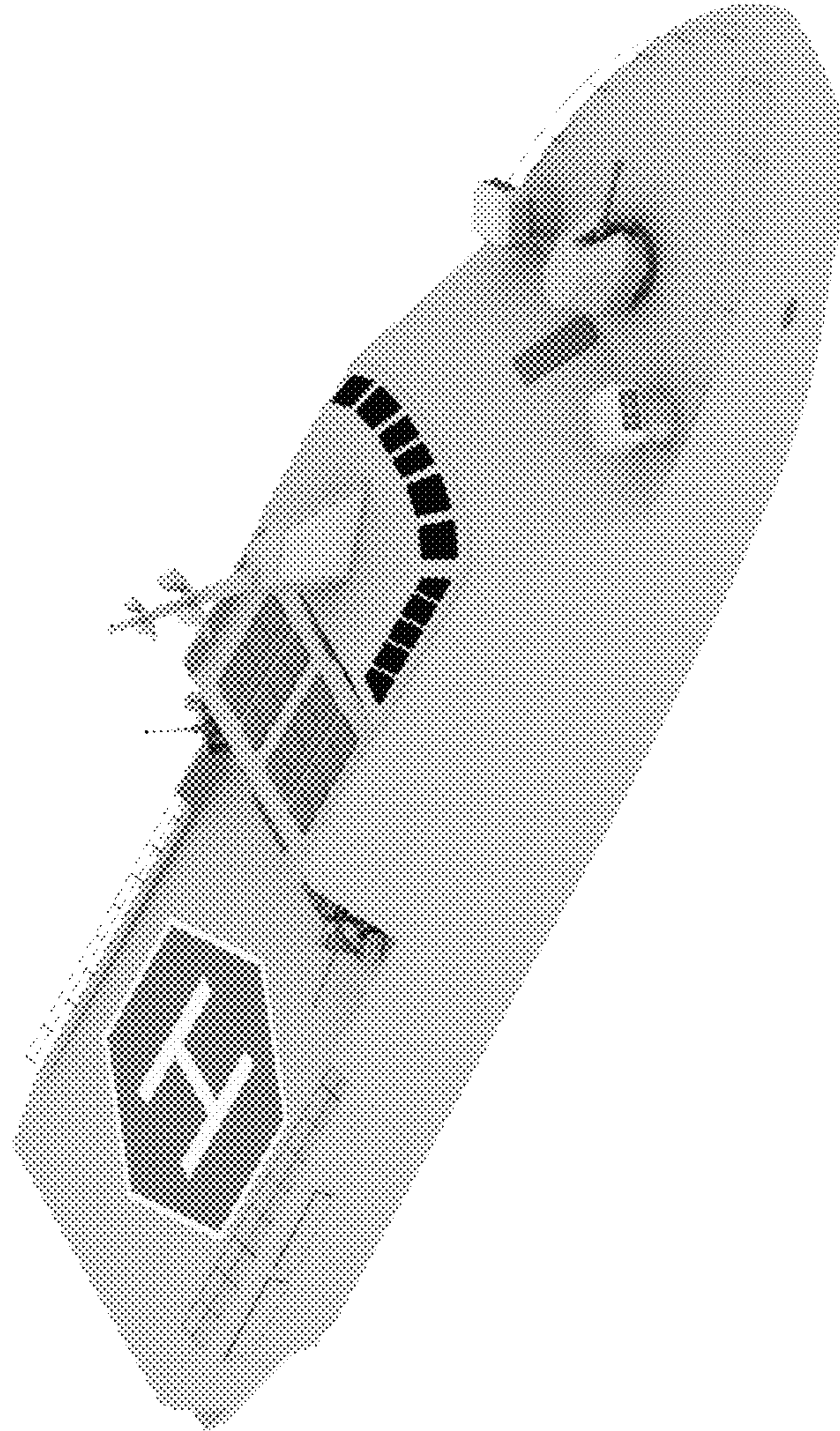

1.2

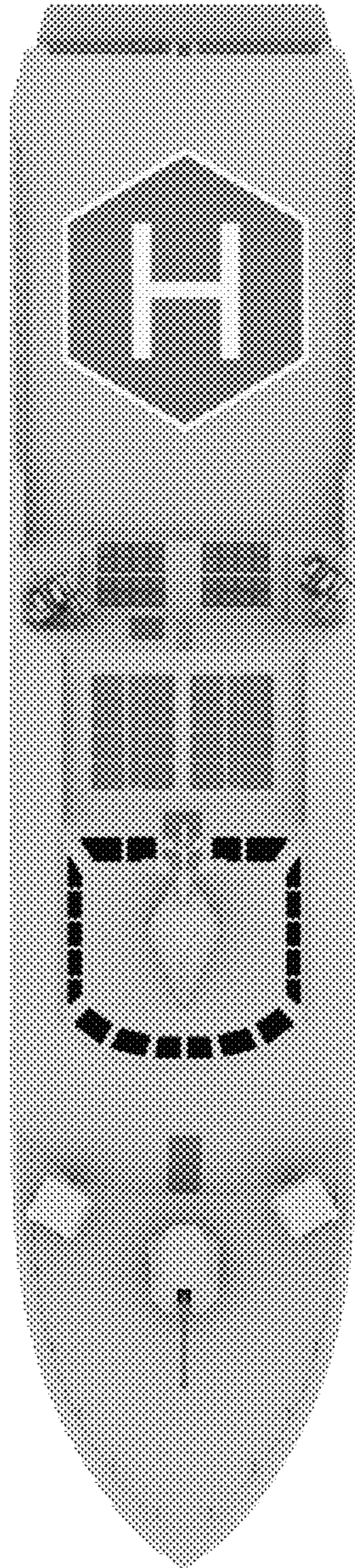

1.3

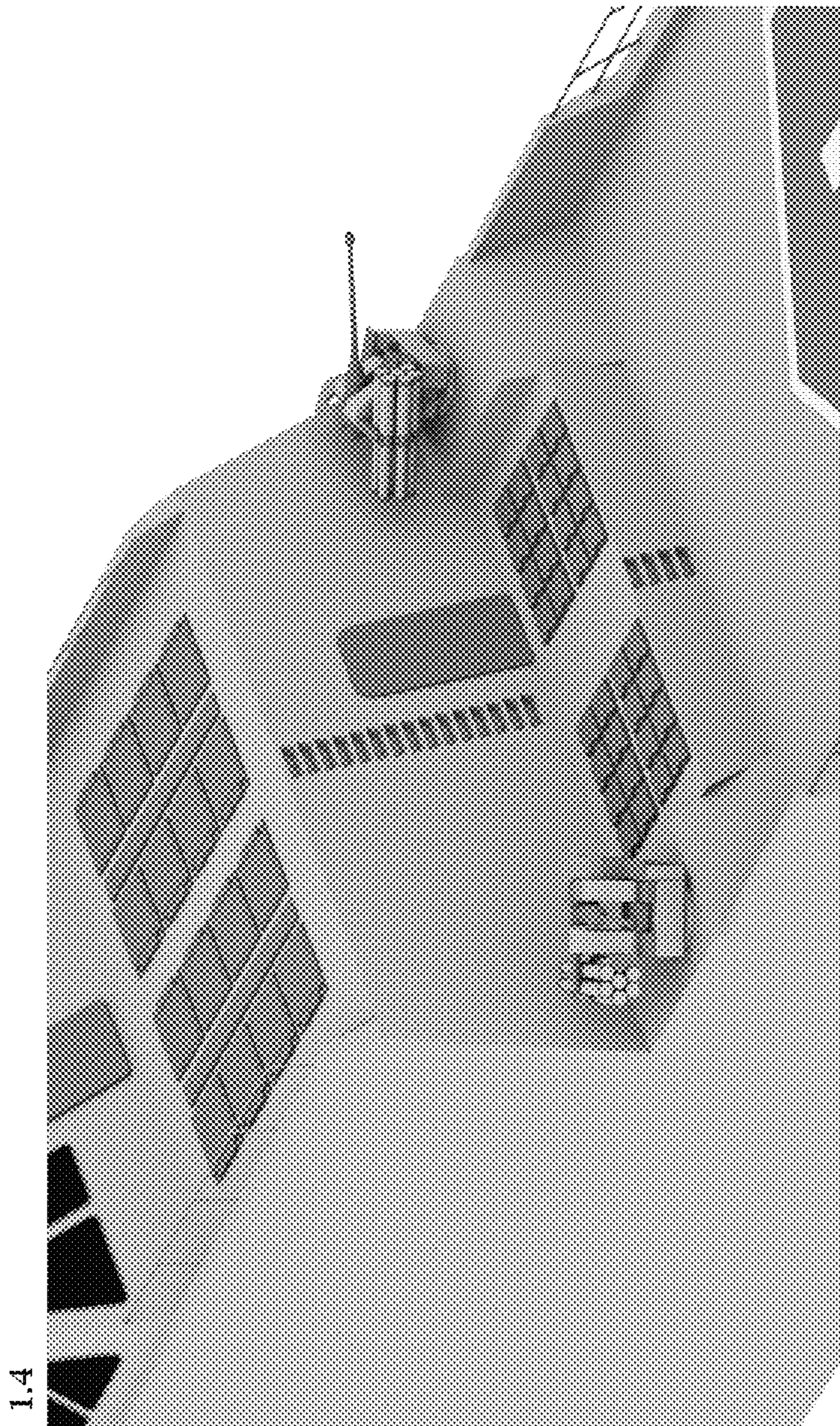

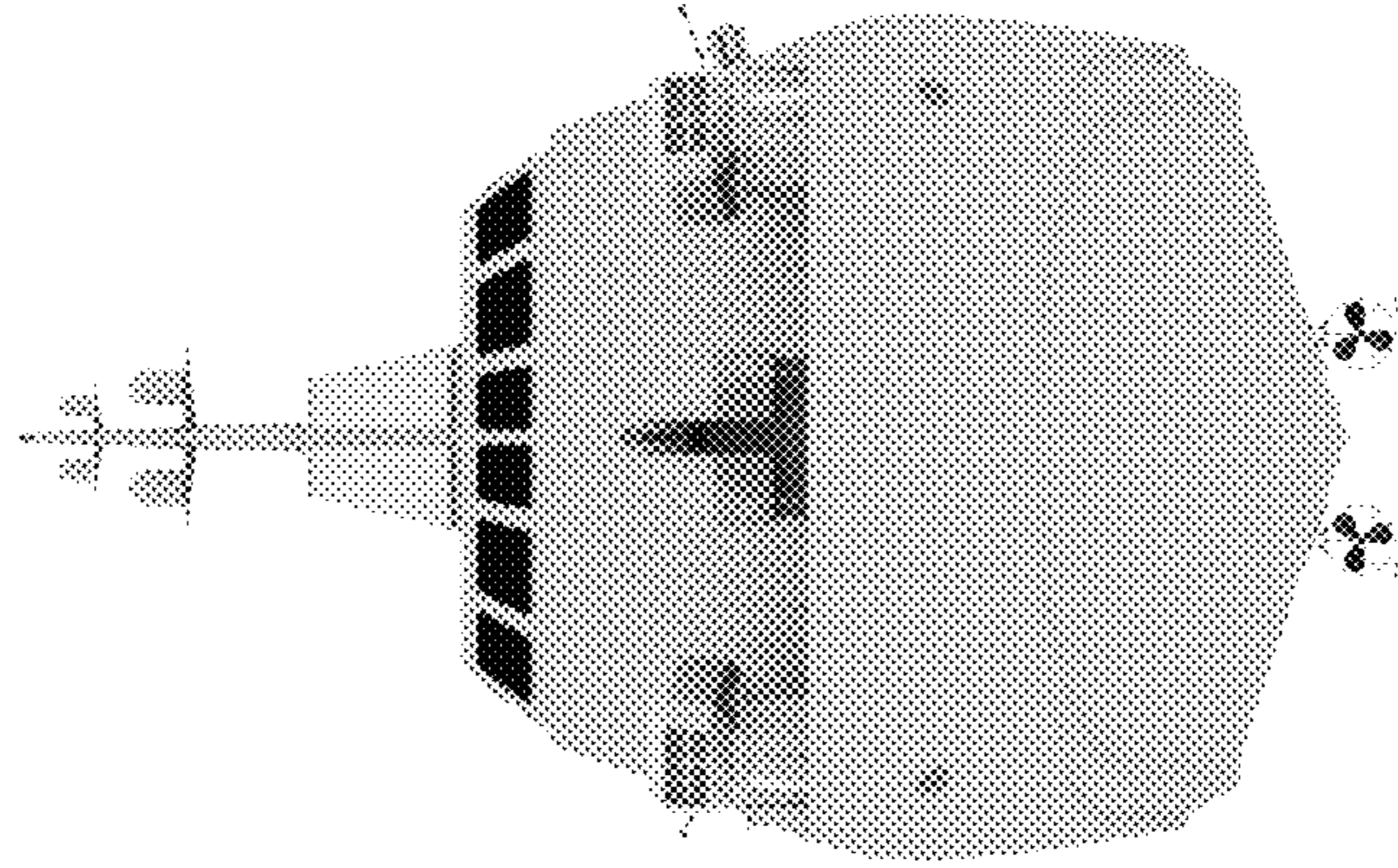

1.5

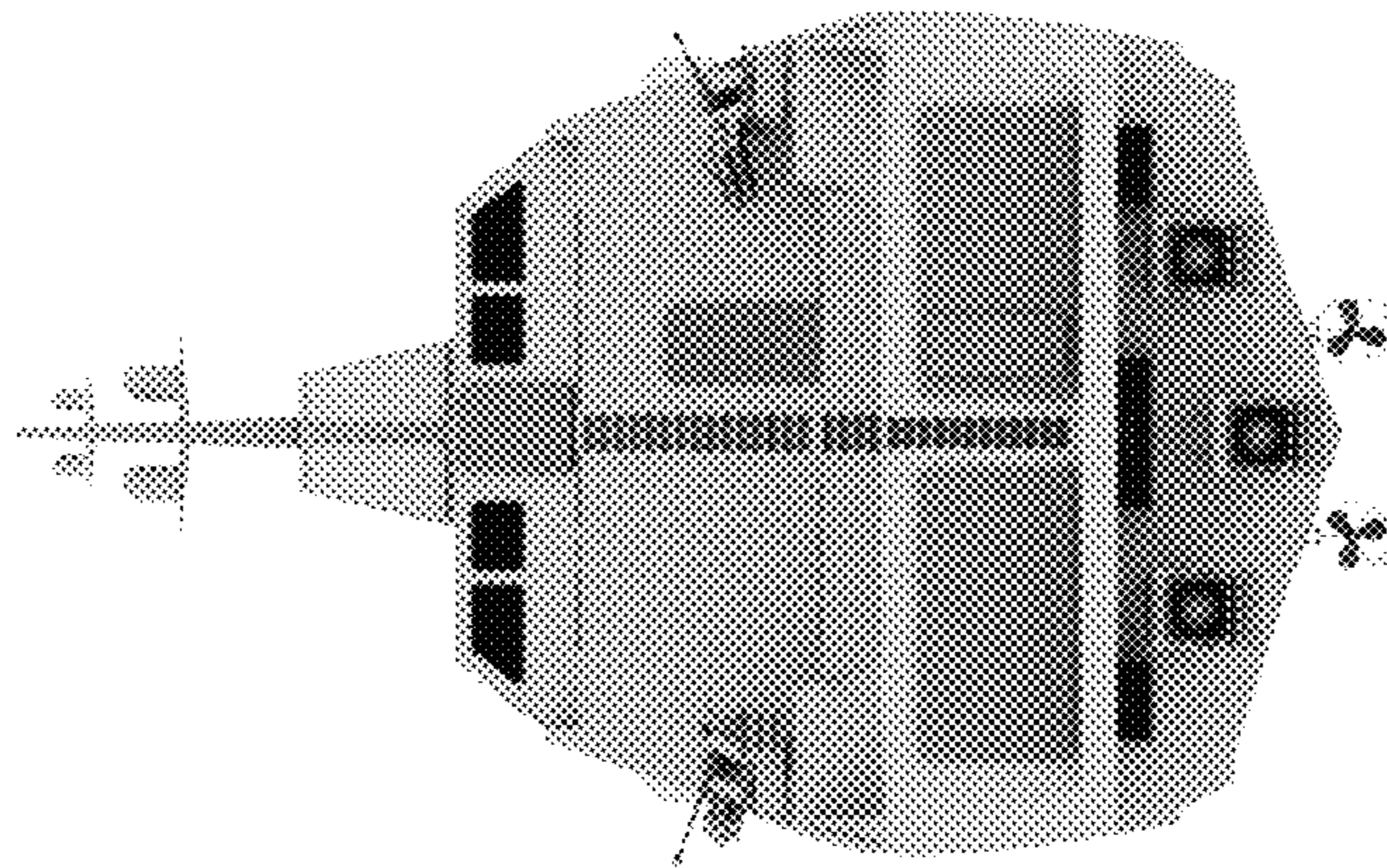

1.6