



US00D966133S

(12) **United States Design Patent** (10) **Patent No.:** **US D966,133 S**
Martin (45) **Date of Patent:** **** Oct. 11, 2022**

(54) **SANITIZER DISPENSER**

(71) Applicant: **Aileen Martin**, Spartanburg, SC (US)

(72) Inventor: **Aileen Martin**, Spartanburg, SC (US)

(**) Term: **15 Years**

(21) Appl. No.: **29/751,334**

(22) Filed: **Sep. 21, 2020**

(51) **LOC (13) Cl.** **11-01**

(52) **U.S. Cl.**
USPC **D11/4**

(58) **Field of Classification Search**
USPC D11/1-4; D3/215; D9/715; D14/189
CPC A44C 5/003
See application file for complete search history.

(56) **References Cited**

U.S. PATENT DOCUMENTS

D346,600	S	*	5/1994	Grasso	D10/34
D560,134	S	*	1/2008	Chen	D11/4
D660,740	S	*	5/2012	Cullen	D11/3
D710,737	S	*	8/2014	West	D11/3
D711,762	S	*	8/2014	Murphy	D11/4
D780,613	S	*	3/2017	Shaukat	D11/2
D934,098	S	*	10/2021	Shaukat	D9/447
D944,514	S	*	3/2022	Anthony	D3/215
2006/0219742	A1	*	10/2006	Chen	A45D 33/33 224/267
2020/0363164	A1	*	11/2020	Jimenez	B05B 11/30
2022/0061473	A1	*	3/2022	Newcomb	A61L 2/26

FOREIGN PATENT DOCUMENTS

CN	303286101	*	7/2015
IL	58898	*	7/2018

OTHER PUBLICATIONS

30ml 50ml Cartoon Children Custom Hand Sanitizer Holder Silicone Hand Sanitizer Holder Cover Alibaba.com pp. 1-10 2022

https://www.alibaba.com/product-detail/30ml-50ml-Cartoon-Children-Custom-Hand_1600082279679.html (Year: 2022).*
Adjustable Adult Hand Sanitizer Bracelet with Bottle—Miss White Rabbit—Walmart.com pp. 1-5 2022 <https://www.walmart.com/ip/Adjustable-Adult-Hand-Sanitizer-Bracelet-with-Bottle-Miss-White-Rabbit/893789592?wmlspartner=wlp&selectedSellerId=%E2%80%A6> (Year: 2022).*
5 Pack Hand Sanitizer Watch for Kids(0.5 oz), Cartoon Wearable Hand Sanitizer Bracelet, Leakproof Refillable Reusable Clip on Hand Sanitizer Wristband with Squeeze Bottle amazon pp. 1-7 2021 https://www.amazon.com/Sanitizer-Wristband-Leakproof-Refillable-Dispenser/product-reviews/B08GCXCL31/ref=cm_cr_ (Year: 2021).*

* cited by examiner

Primary Examiner — Kevin K Rudzinski
Assistant Examiner — Evans David Delesline
(74) *Attorney, Agent, or Firm* — Gulf Coast Intellectual Property Group

(57) **CLAIM**

The ornamental design for the sanitizer dispenser, as shown and described.

DESCRIPTION

FIG. 1 is a perspective view of the sanitizer dispenser of present invention; and
FIG. 2 is a front elevation view thereof; and
FIG. 3 is a rear elevation view thereof; and
FIG. 4 is a left side view thereof; and
FIG. 5 is right side view thereof; and
FIG. 6 is a top view of the present invention; and
FIG. 7 is a bottom view of the present invention.
The broken lines shown in the drawings are included for purpose of illustrating environmental structure and form no part of the claimed design.

1 Claim, 3 Drawing Sheets

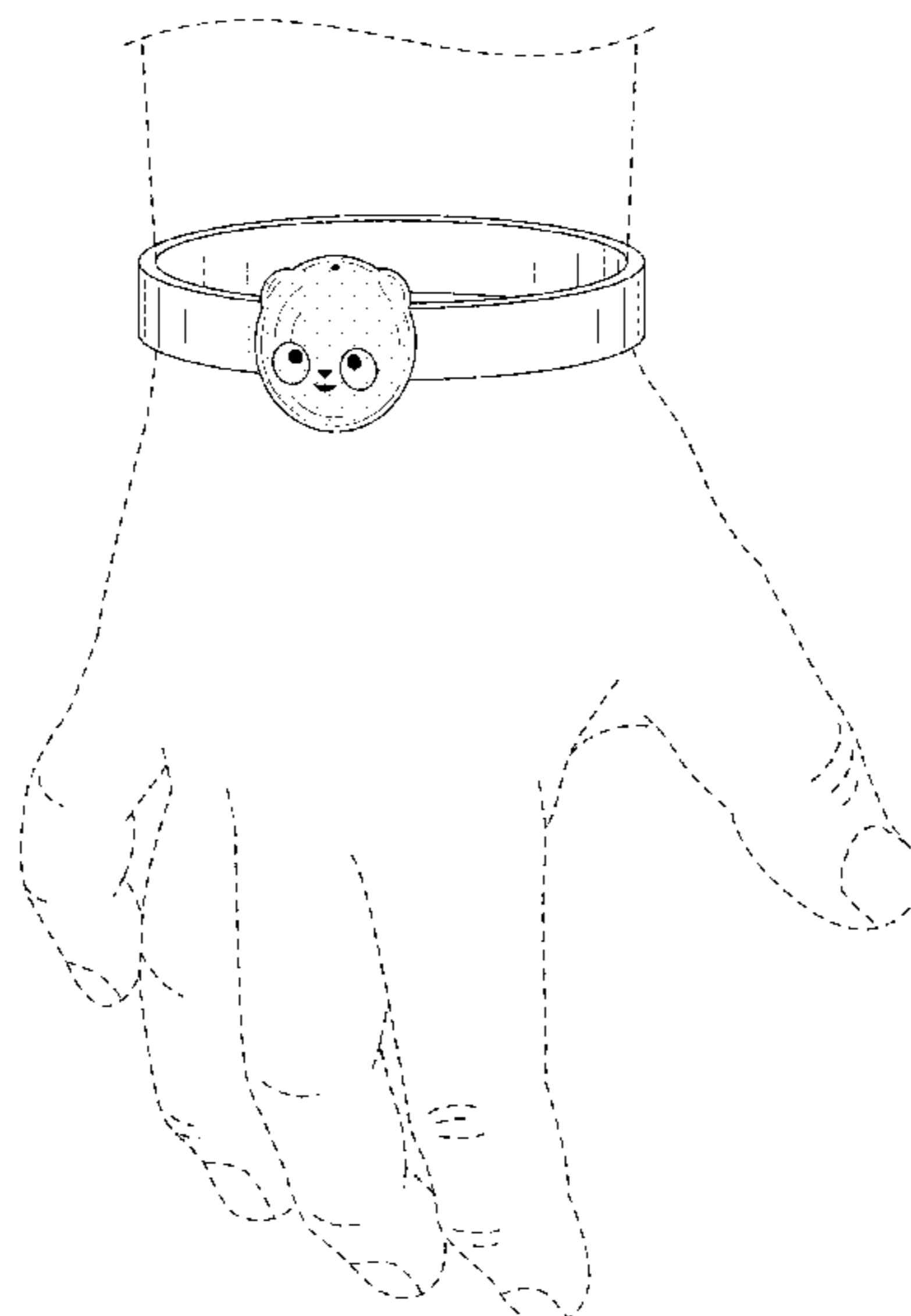

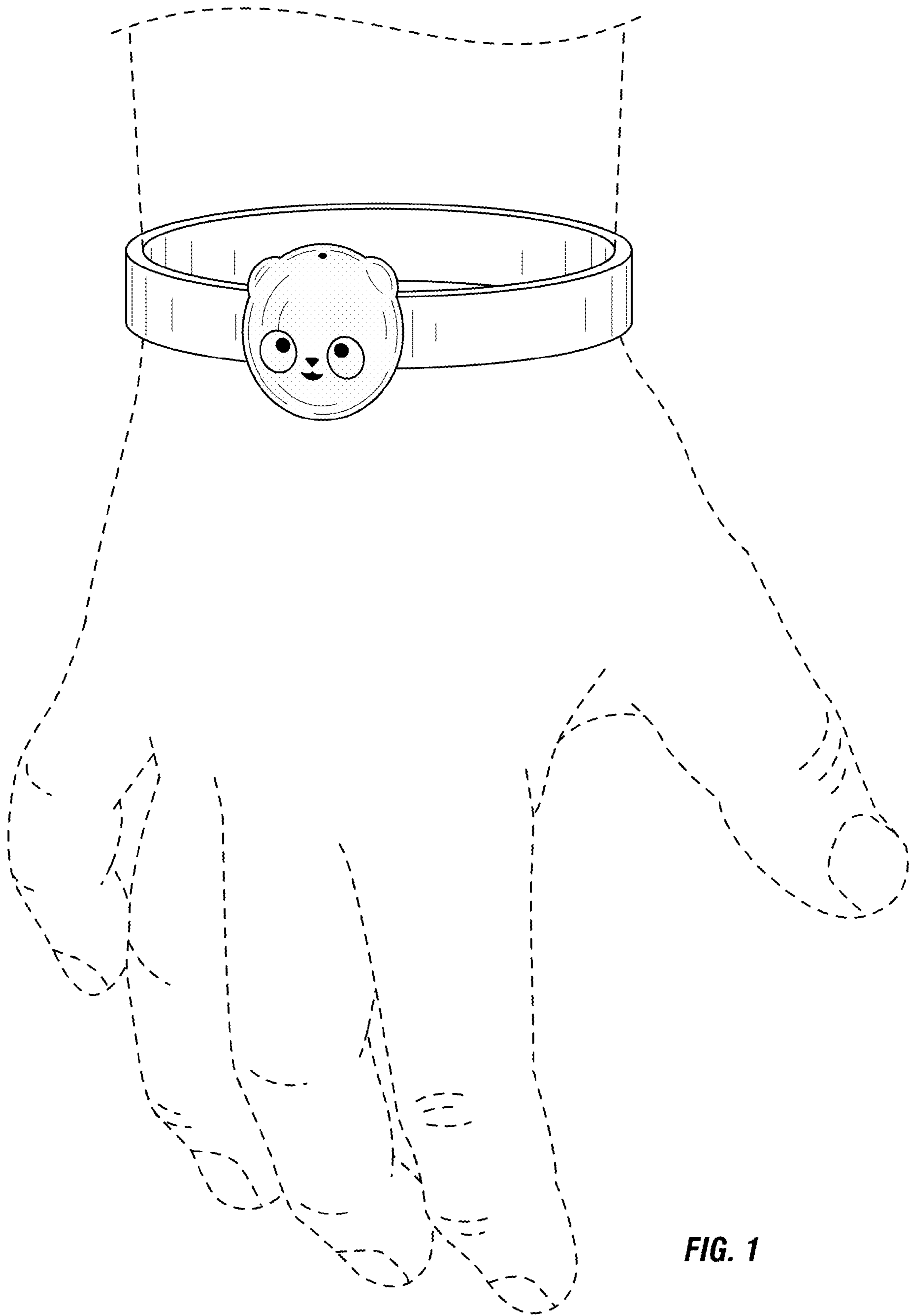

FIG. 1

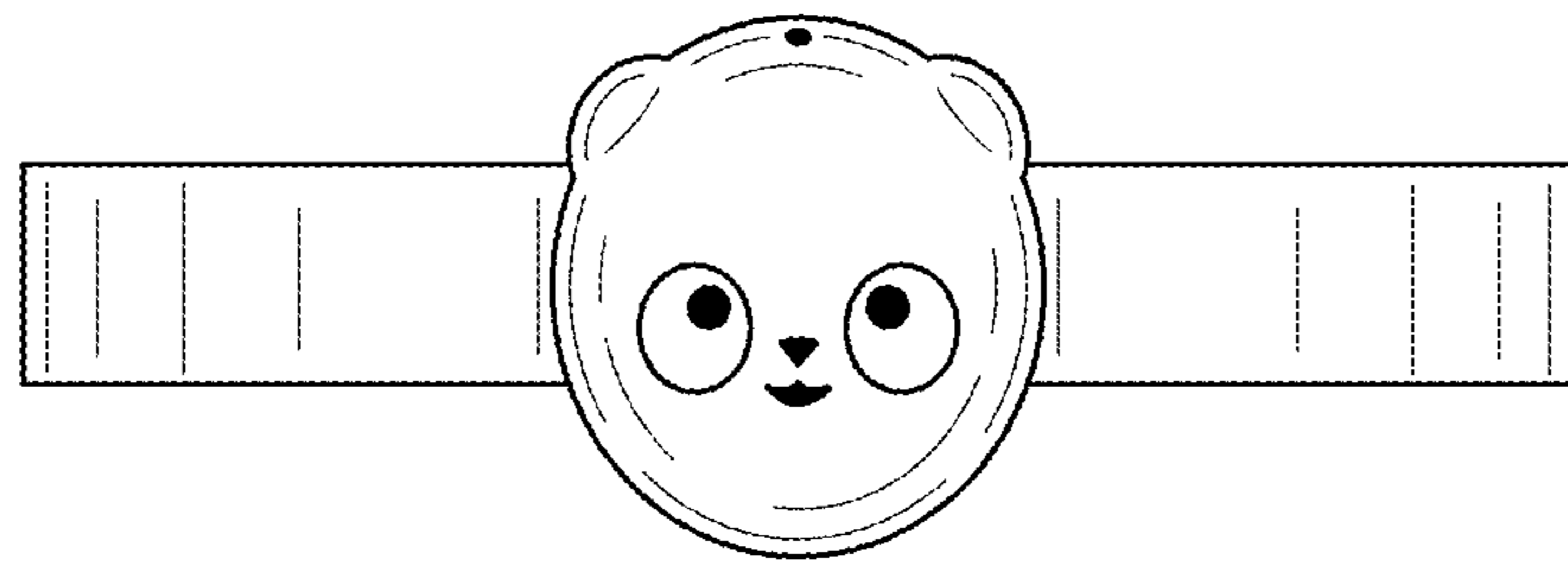

FIG. 2

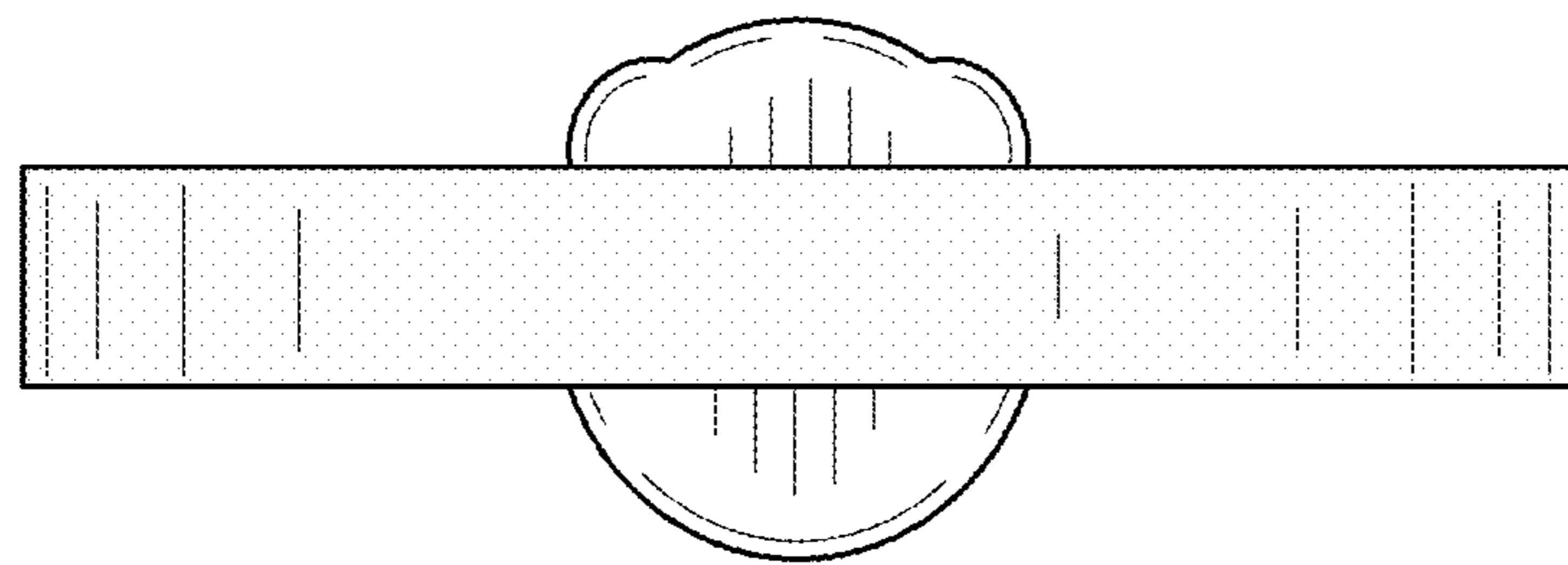

FIG. 3

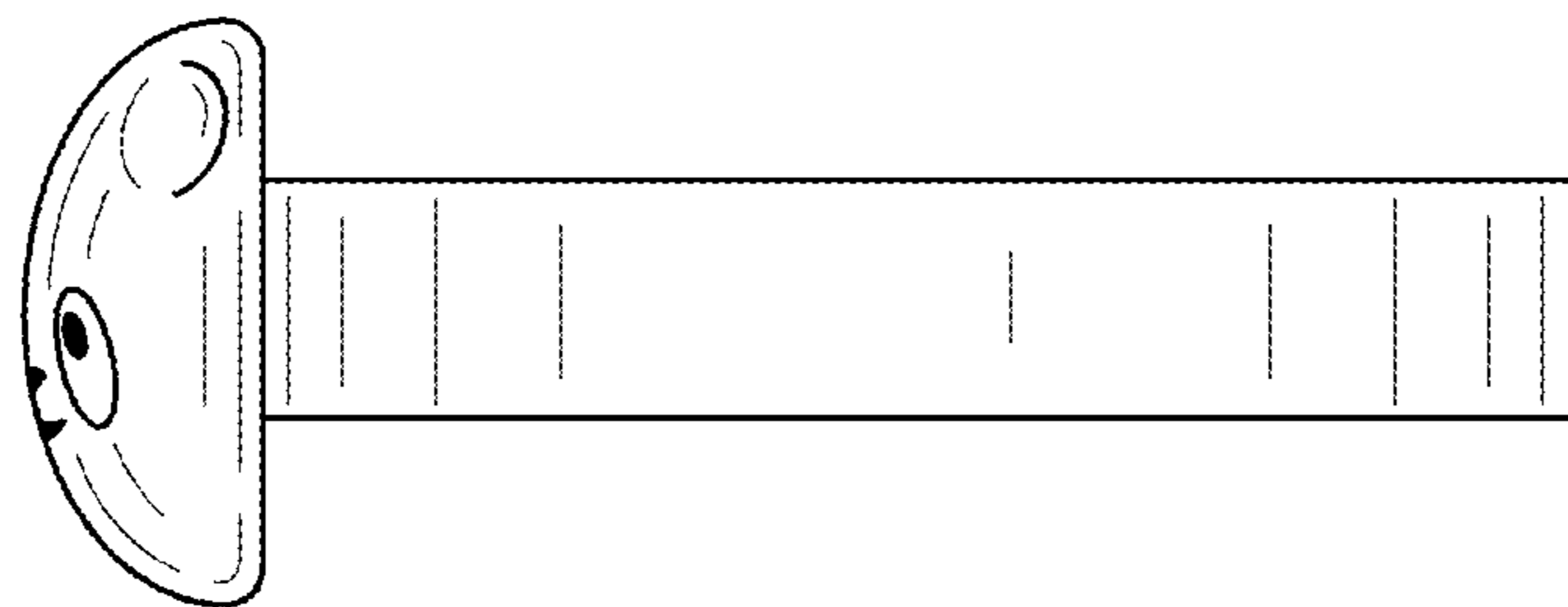

FIG. 4

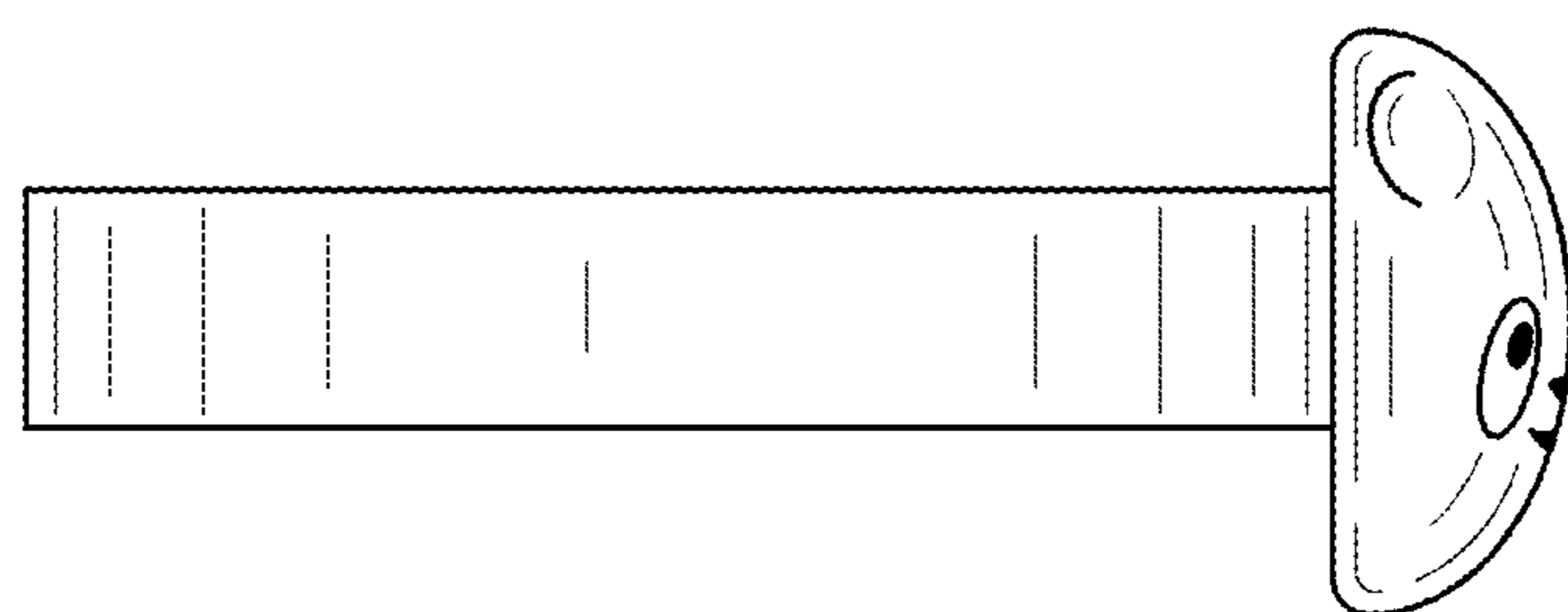

FIG. 5

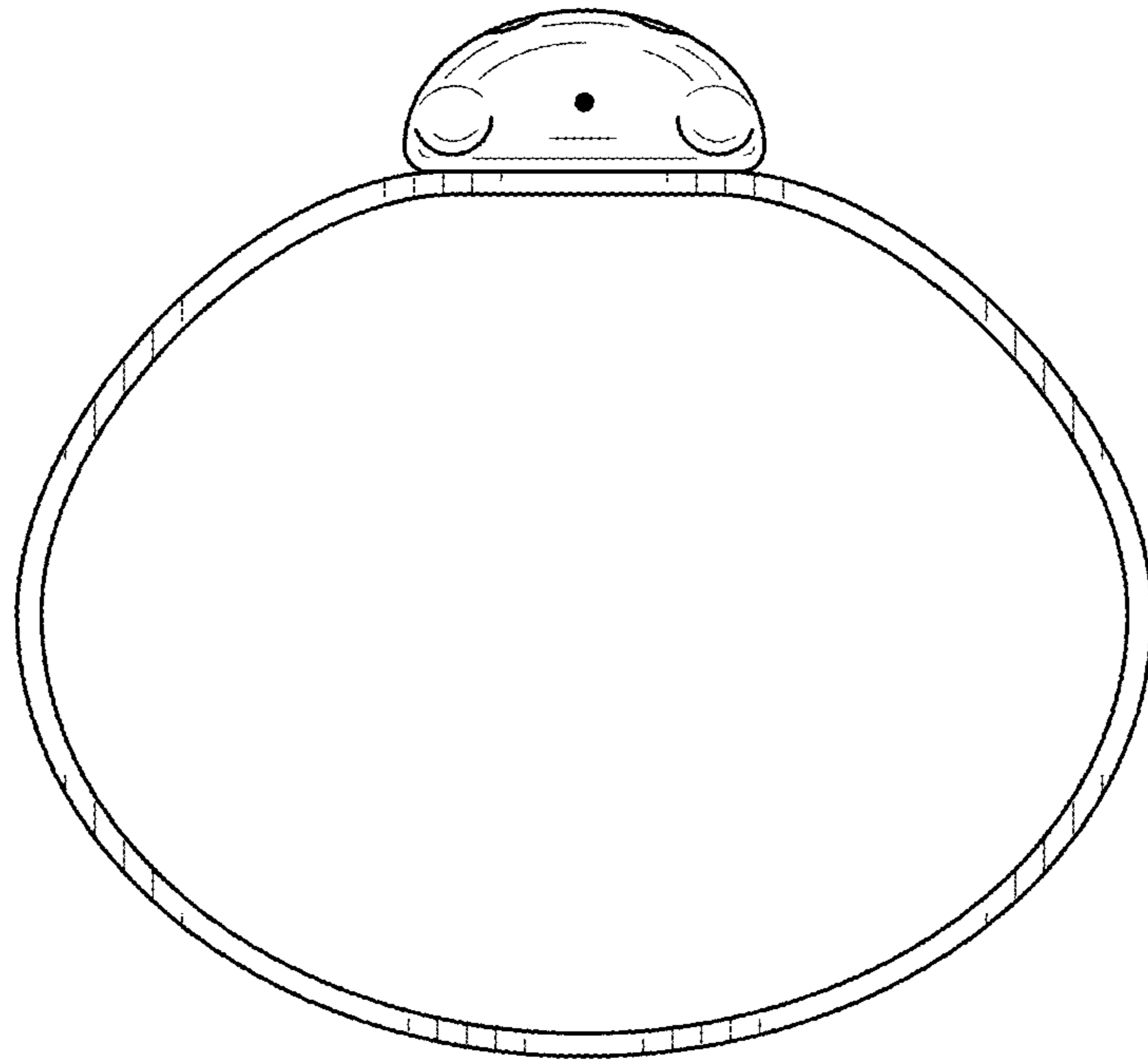

FIG. 6

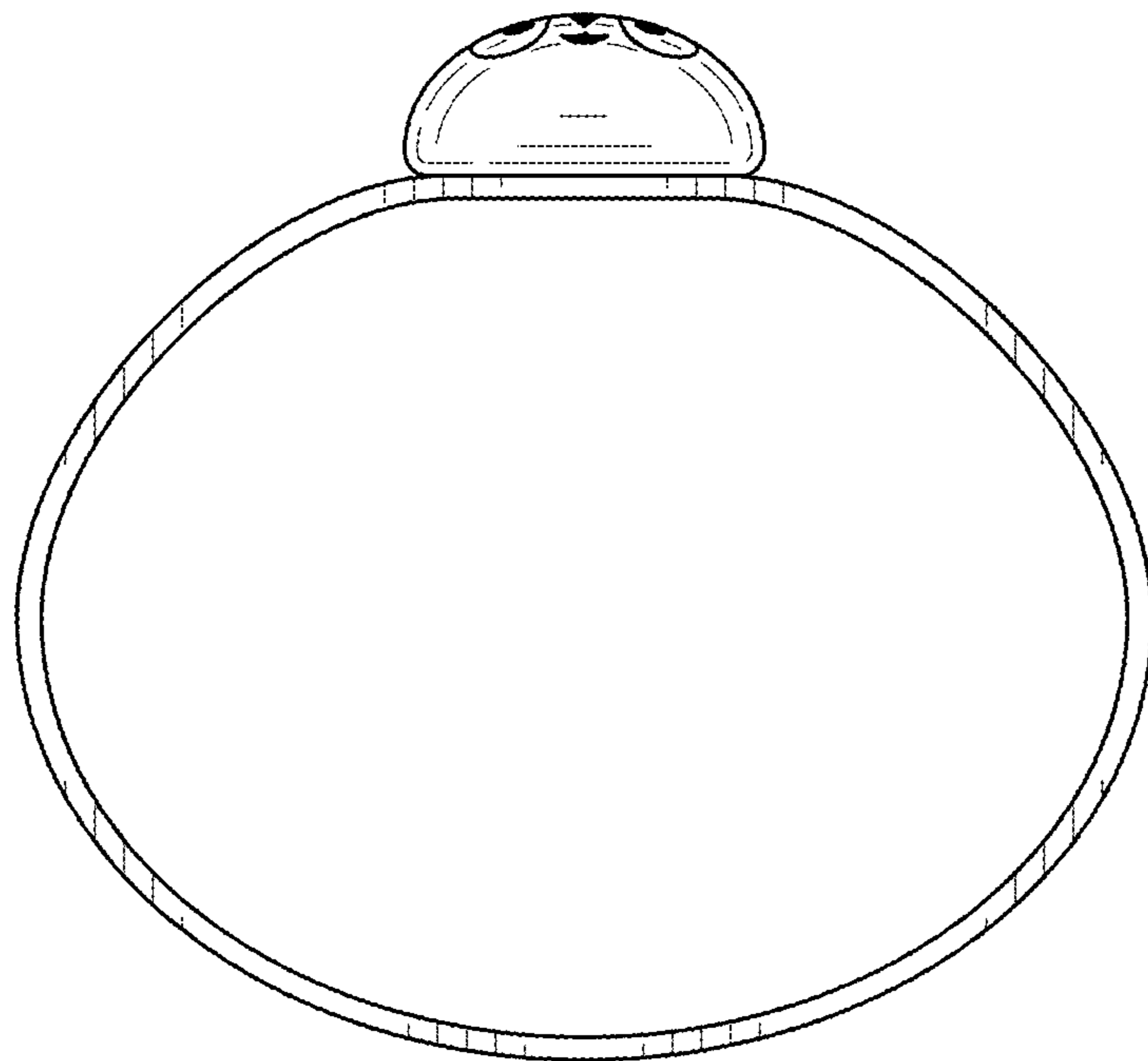

FIG. 7