



US00D966100S

(12) **United States Design Patent**
Naukkarinen

(10) **Patent No.:** **US D966,100 S**
(45) **Date of Patent:** **** Oct. 11, 2022**

(54) **PACKAGING**

(71) Applicant: **AR Packaging Systems AB**, Lund (SE)

(72) Inventor: **Anna Naukkarinen**, Helsingborg (SE)

(73) Assignee: **AR PACKAGING SYSTEMS AB**,
Lund (SE)

(**) Term: **15 Years**

(21) Appl. No.: **29/737,223**

(22) Filed: **Jun. 7, 2020**

(30) **Foreign Application Priority Data**

May 22, 2020 (EM) 007960885-0004
May 22, 2020 (EM) 007960885-0005
May 22, 2020 (EM) 007960885-0006

(51) **LOC (13) Cl.** **09-03**

(52) **U.S. Cl.**
USPC **D9/432; D9/430**

(58) **Field of Classification Search**
USPC D9/420, 421, 423, 424, 425, 434, 499,
D9/422, 428, 429, 500, 501, 502, 503,
(Continued)

(56) **References Cited**

U.S. PATENT DOCUMENTS

1,862,301 A * 6/1932 Drexler B65D 65/40
229/125.17
D185,674 S * 7/1959 Lumley D34/1
(Continued)

FOREIGN PATENT DOCUMENTS

WO WO-2021172848 A1 * 9/2021

OTHER PUBLICATIONS

Graphic Packaging International. Presentation of the first Boardio® launch outside of Europe at PAC Disruptors Summit! Publication

date unavailable. Visited Mar. 7, 2022. <https://www.ar-packaging.com/en/news-and-cases/boardio-launch-in-north-america> (Year: 0).*

(Continued)

Primary Examiner — Darcey E Gottschalk

Assistant Examiner — Vanessa M. Pursley

(74) *Attorney, Agent, or Firm* — Tucker Ellis LLP

(57) **CLAIM**

The ornamental design for a packaging, as shown and described.

DESCRIPTION

FIG. 1 is a front, left side, top perspective view of a first embodiment of packaging showing my new design; FIG. 2 is a rear, right side, bottom perspective view thereof; FIG. 3 is a front view thereof; FIG. 4 is a rear view thereof; FIG. 5 is a right side view thereof; FIG. 6 is a left side view thereof; FIG. 7 is a top view thereof; FIG. 8 is a bottom view thereof; FIG. 9 is a front, left side, top perspective view of a second embodiment of the packaging; FIG. 10 is a rear, right side, bottom perspective view thereof; FIG. 11 is a front view thereof; FIG. 12 is a rear view thereof; FIG. 13 is a right side view thereof; FIG. 14 is a left side view thereof; FIG. 15 is a top view thereof; and, FIG. 16 is a bottom view thereof.

The vertical broken lines along the right side of the packaging in the drawings illustrate portions of the packaging that form no part of the claimed design. The additional broken lines in the second embodiment are for the purpose of illustrating portions of the packaging with a symbolic break in its height. The appearance of any portion of the article between the break lines forms no part of the claimed design.

1 Claim, 8 Drawing Sheets

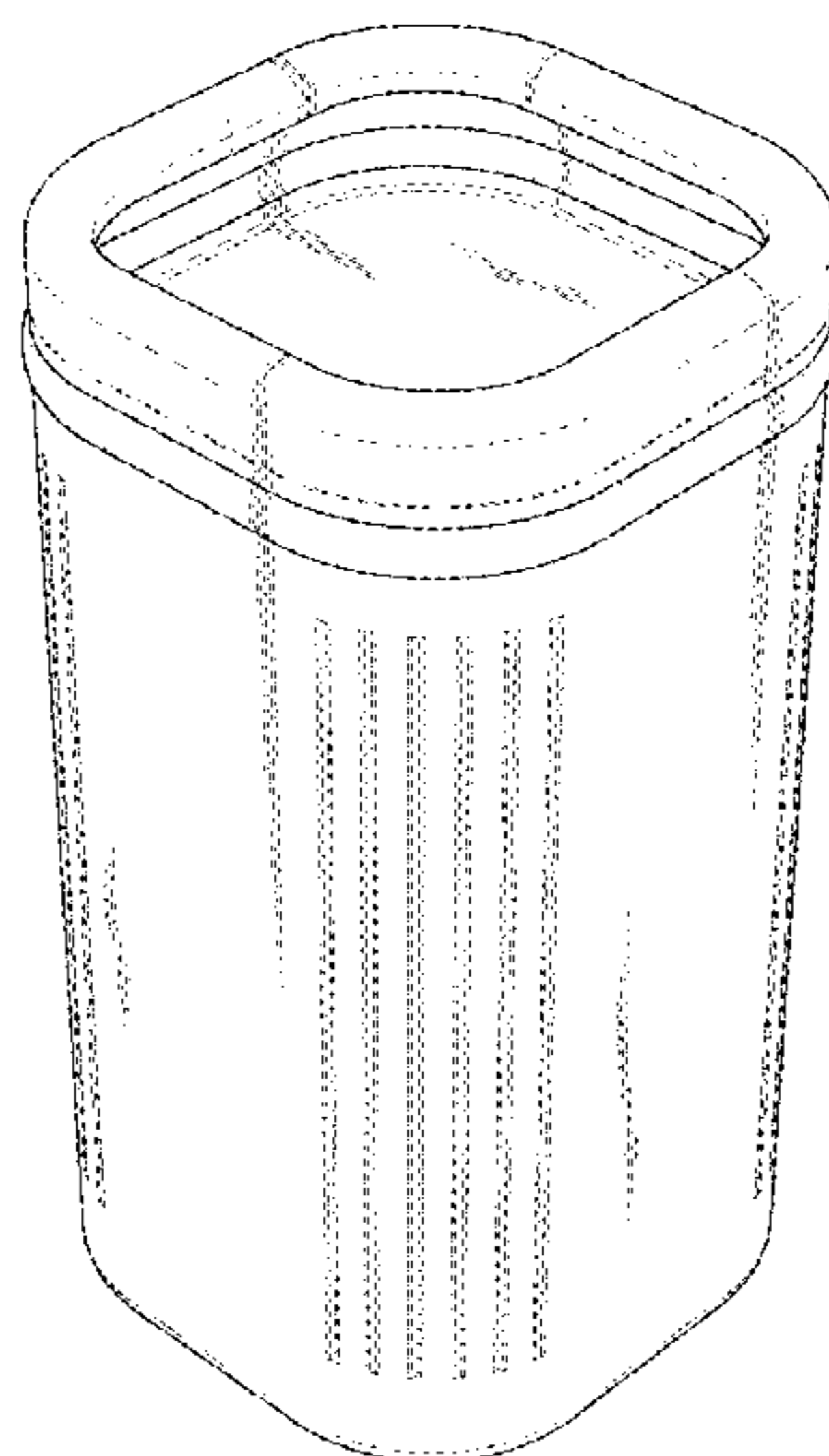

(58) **Field of Classification Search**

USPC D9/504, 414–419, 430–432; D7/600,
D7/601; D3/201, 202, 203.1, 203.2,
D3/203.5, 203.8, 204–207, 212, 276, 282;
D34/1, 5–11

CPC ... B65D 1/12; B65D 1/10; B65D 1/14; B65D
25/00; B65D 43/02

See application file for complete search history.

(56) **References Cited**

U.S. PATENT DOCUMENTS

3,454,207 A * 7/1969 Jackson B65D 15/06
229/4.5
D276,401 S * 11/1984 Daenen D9/425
D279,952 S * 8/1985 Daenen D9/425
D283,596 S * 4/1986 Fortuna D7/510
D294,446 S * 3/1988 Tardif D7/612
D316,036 S * 4/1991 Kaplan D9/423
D336,017 S * 6/1993 Smith D9/425
D336,244 S * 6/1993 Arai D9/414
D342,817 S * 12/1993 Lippisch D34/1
D343,795 S * 2/1994 Verchere D9/425
D344,889 S * 3/1994 Kozlowski D3/203.2
D358,531 S * 5/1995 Cousins D9/504
D382,177 S * 8/1997 Ahern, Jr. D9/429
D419,442 S * 1/2000 McClung D9/425
D463,282 S * 9/2002 Mitchell D9/500
D471,102 S * 3/2003 Gehring D9/432
D490,704 S * 6/2004 Atkinson D9/432
D503,872 S * 4/2005 Armato D7/629
D525,120 S * 7/2006 Maskell D9/428
D542,650 S * 5/2007 McDowell D9/423
D546,175 S * 7/2007 Sainz D9/420
D555,317 S * 11/2007 Yang D34/1
7,370,788 B1 * 5/2008 Otani B65D 1/0215
229/407
D571,197 S * 6/2008 Sanfilippo D9/423
D573,390 S * 7/2008 Ablo D7/509
D618,905 S * 7/2010 Watson D3/203.5

D628,080 S * 11/2010 Van Heerikhuize D9/503
D634,911 S * 3/2011 Yang D34/7
D661,182 S * 6/2012 Noer D9/417
D663,111 S * 7/2012 Paslawski D3/203.2
D684,824 S * 6/2013 Sweet D7/629
D712,703 S * 9/2014 Lipinski D7/602
D752,973 S * 4/2016 Thurin D7/629
D763,072 S * 8/2016 Morgan D9/428
D763,681 S * 8/2016 Morgan D9/428
D770,296 S * 11/2016 Rothfos D9/432
D770,888 S * 11/2016 Bougay D9/432
D807,170 S * 1/2018 Fisher D9/428
D833,268 S * 11/2018 Werth D9/414
D843,830 S * 3/2019 Hansen D9/428
D848,832 S * 5/2019 Blomberg D9/428
D876,949 S * 3/2020 Dietvorst D9/420
D919,429 S * 5/2021 Timar D9/428
11,072,444 B2 * 7/2021 Holka B65B 7/2878
D953,856 S * 6/2022 Glassman D9/416
D953,857 S * 6/2022 Glassman D9/416
2015/0021321 A1 * 1/2015 Gosen B65D 21/0204
220/802
2021/0323716 A1 * 10/2021 Sunning B65D 77/2004

OTHER PUBLICATIONS

Youtube. AR Packaging—Boost your brand with Boardio®. Published by AR Packaging Group AB on Nov. 9, 2020. Visited Mar. 7, 2022. <https://www.youtube.com/watch?v=bgttJVTnI4I> (Year: 2020).*

Packaging Gateway. A&R Carton presents new Boardio composite can. Published Mar. 15, 2019. Visited Mar. 7, 2022. <https://www.packaging-gateway.com/news/ar-carton-boardio-composite-can/> (Year: 2019).*

AR Packaging. ARP Boardio®_Mentos Pure Fresh gum H109 new mint design. Published Aug. 5, 2021. Visited Mar. 7, 2022. <https://news.cision.com/ar-packaging/i/arp-boardio-mentos-pure-fresh-gum-h109-new-mint-design,c2939939> (Year: 2021).*

Facebook. Nespresso recycling bin. Posted by Nespresso on Mar. 17, 2020. Visited Mar. 9, 2022. <https://m.facebook.com/Nespresso.AU/photos/2704453349677896/> (Year: 2020).*

* cited by examiner

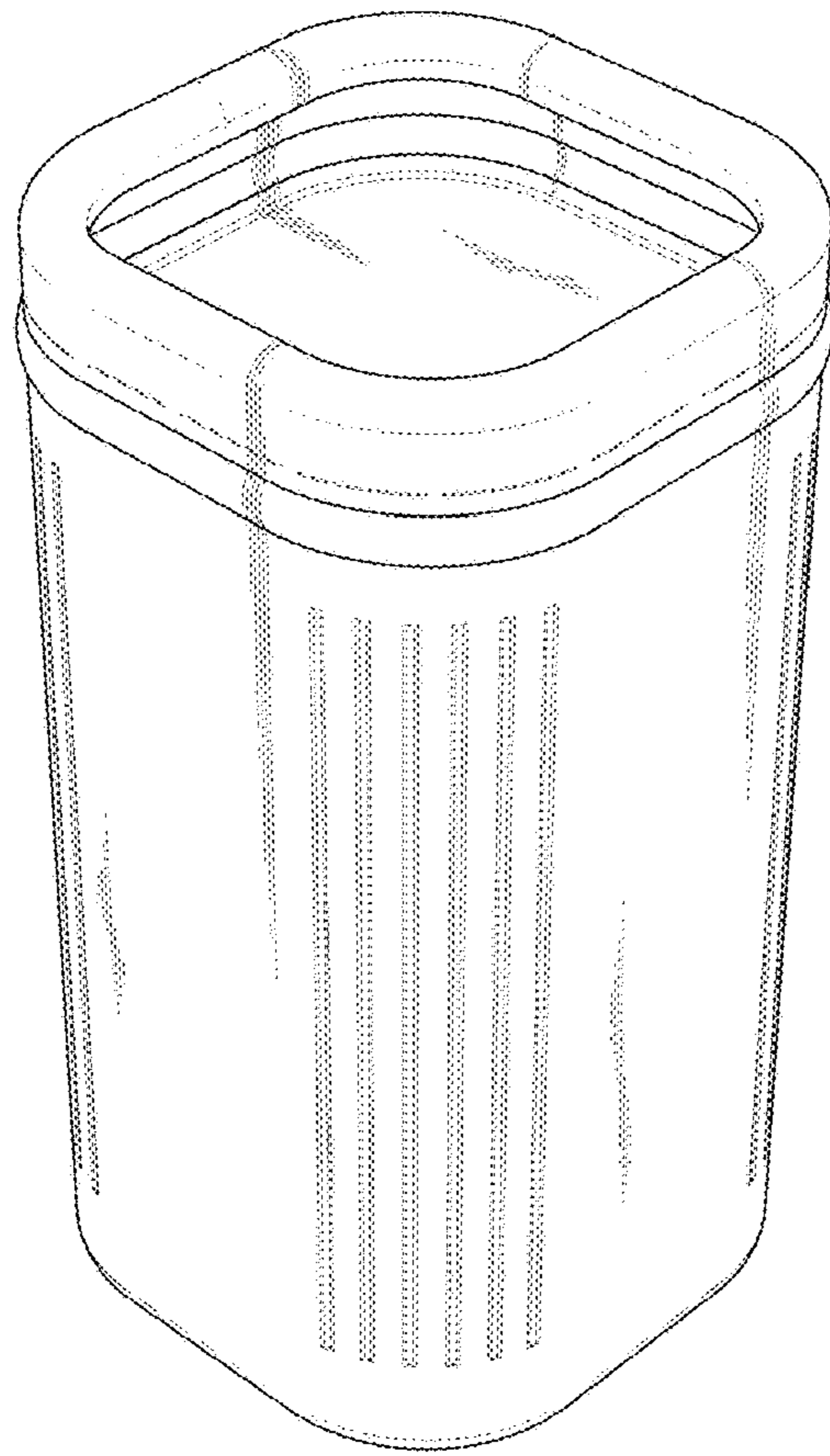

FIG. 1

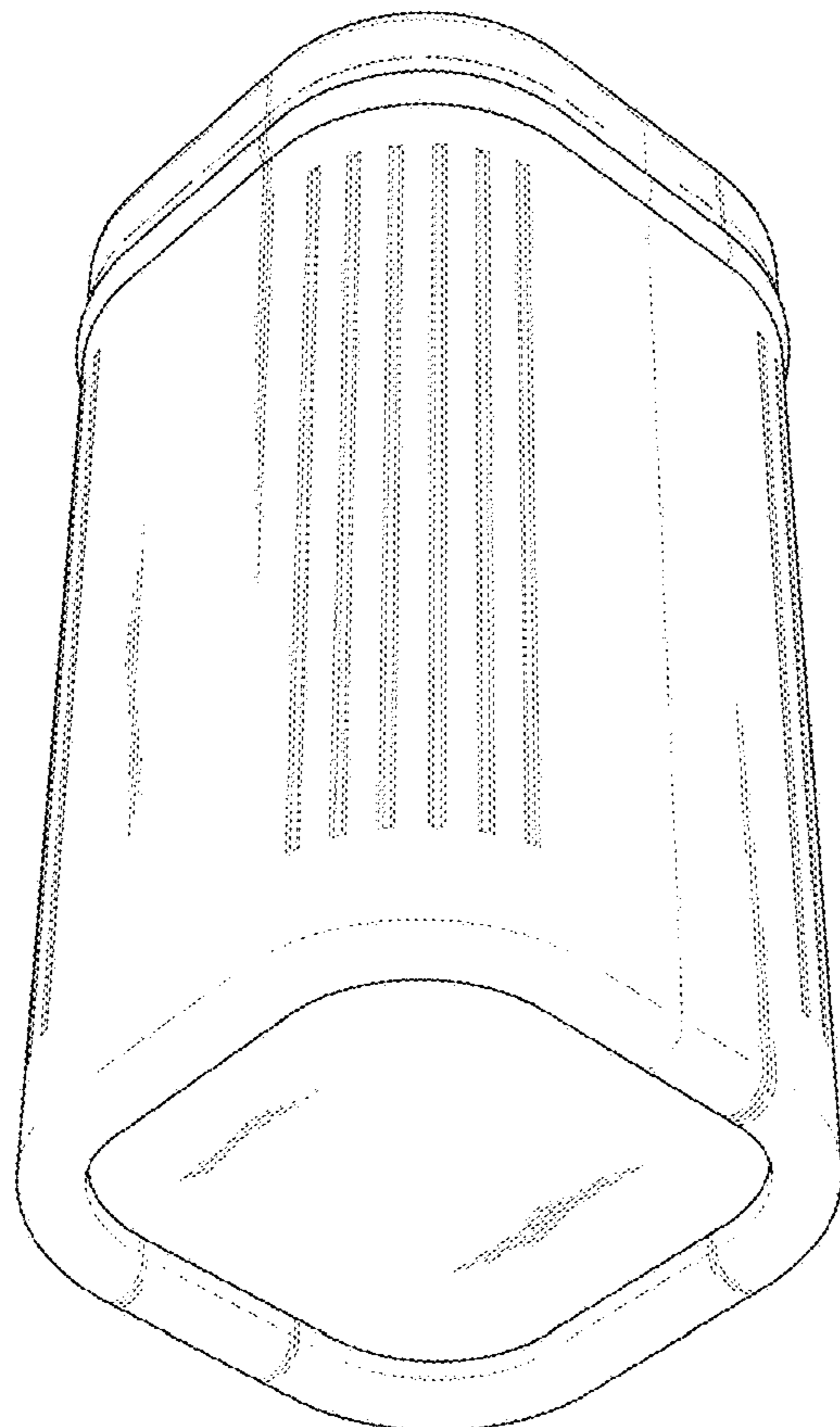

FIG. 2



FIG. 3

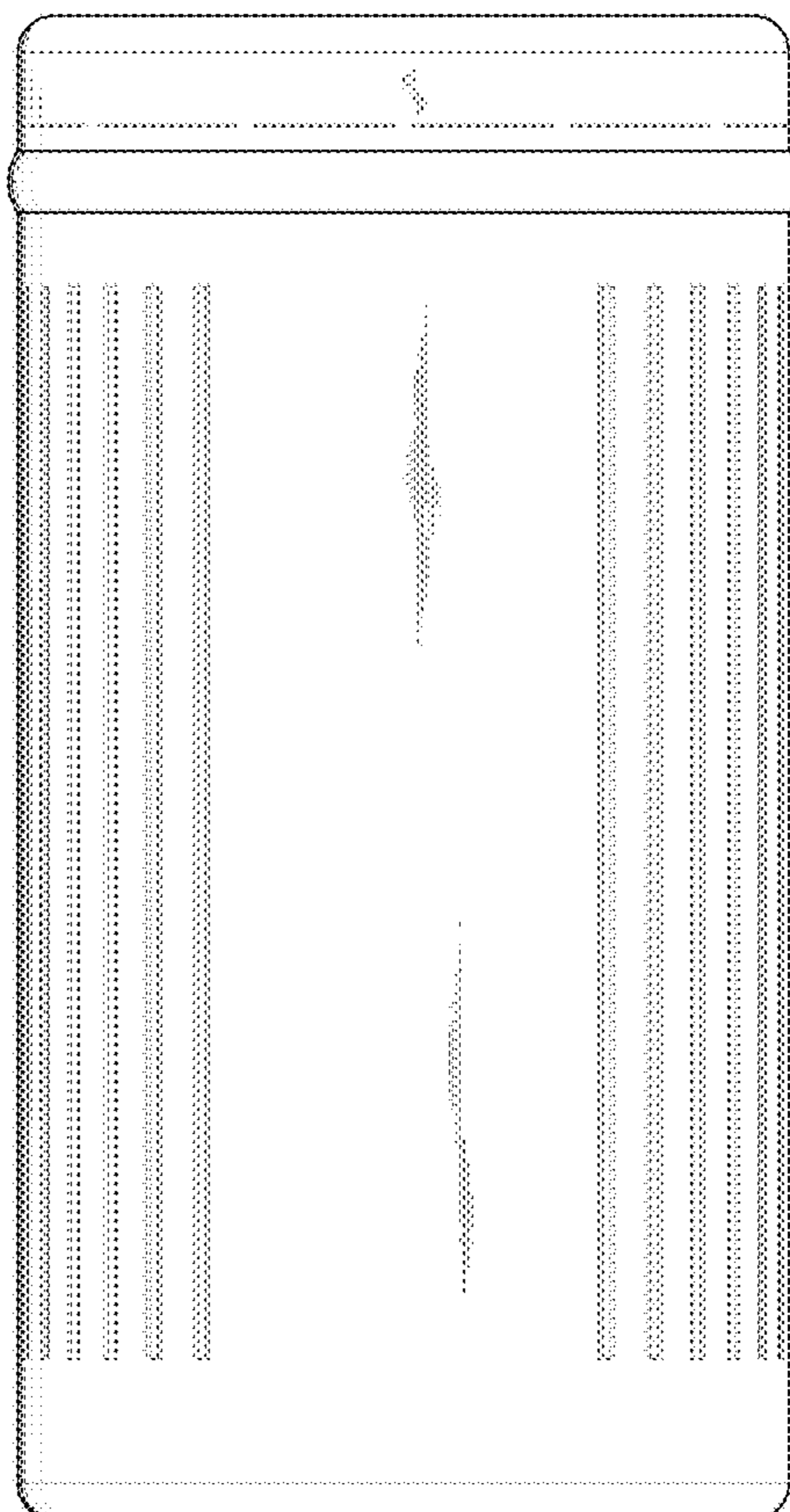

FIG. 4

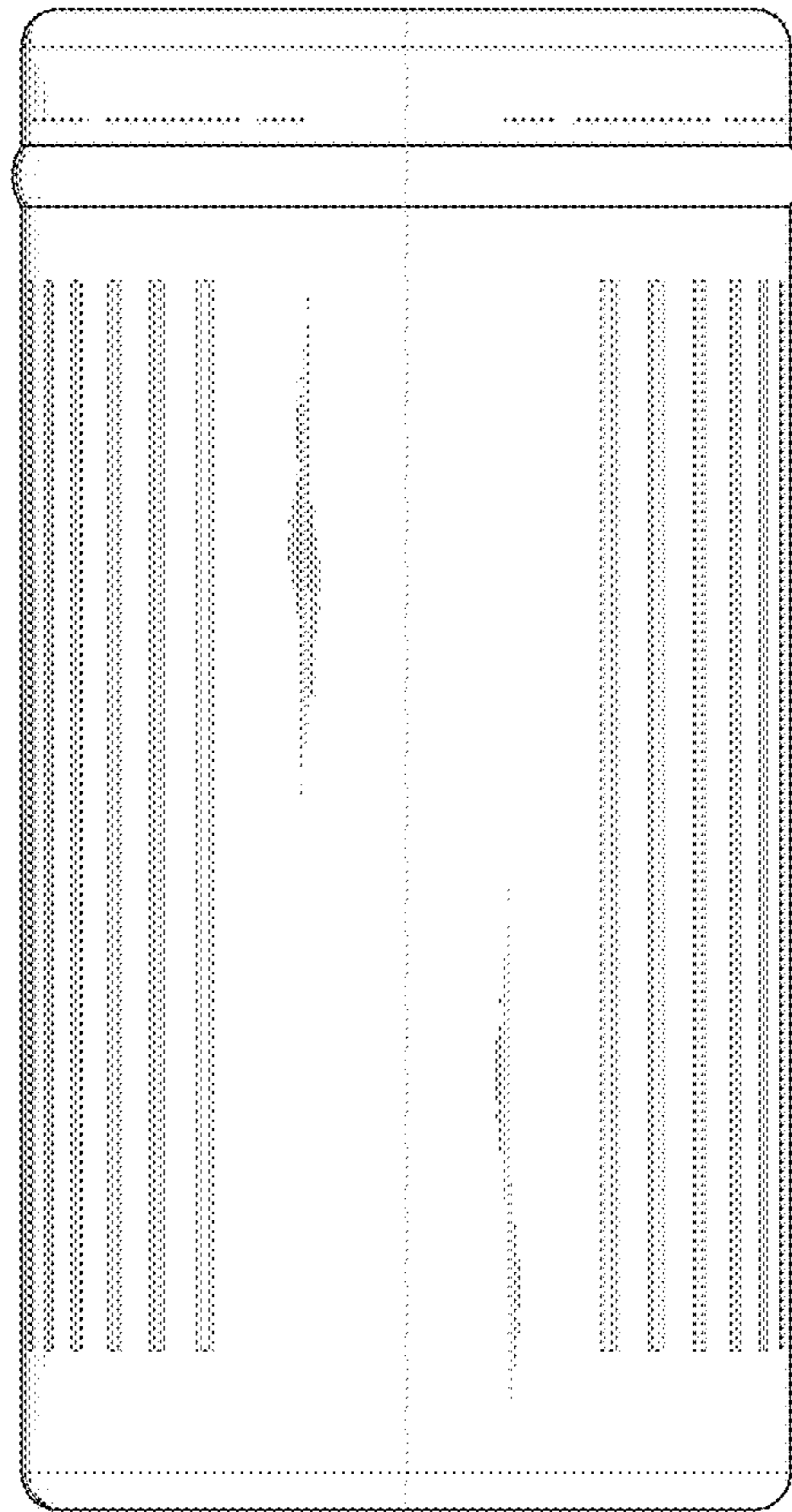

FIG. 5

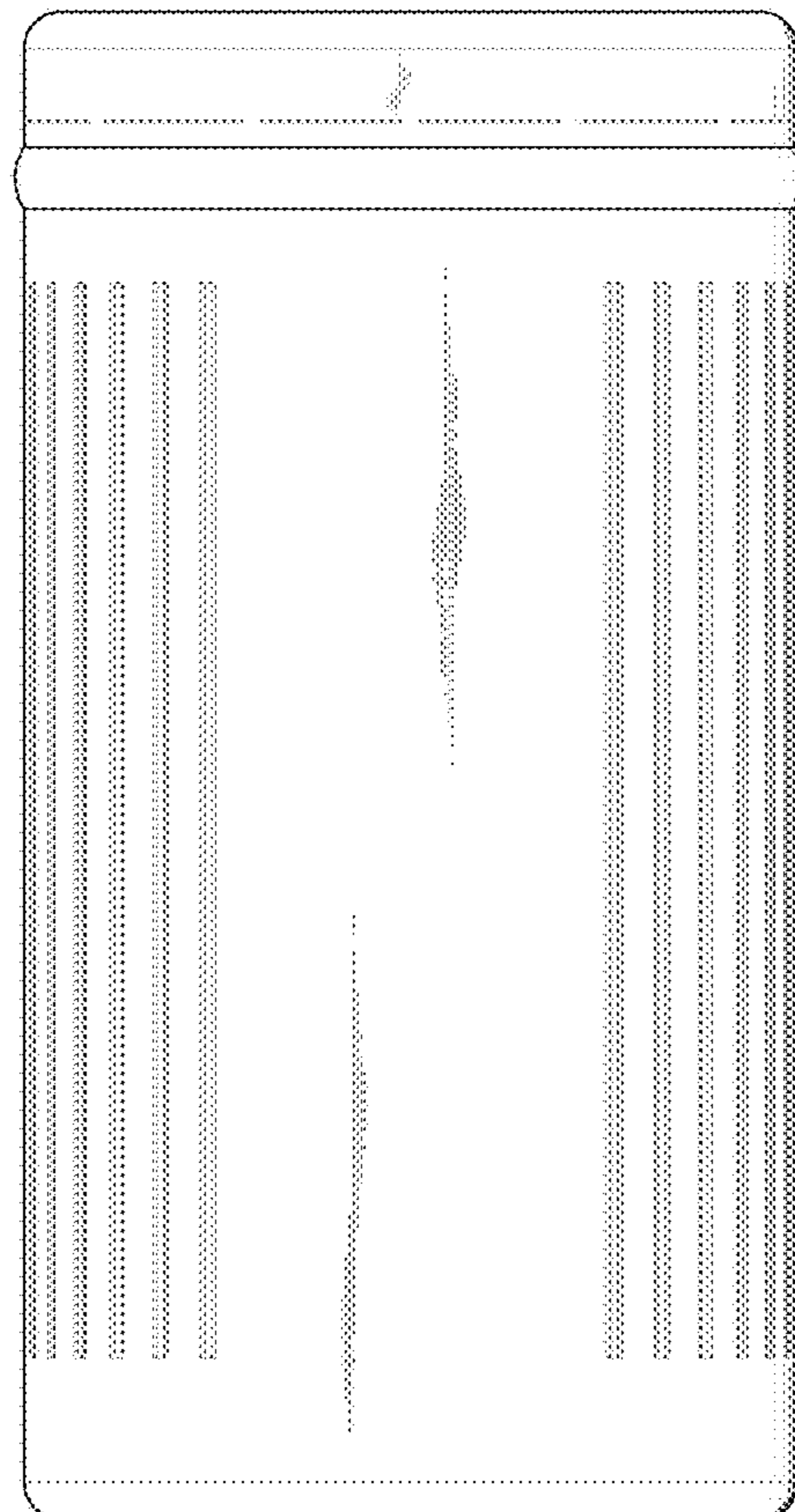

FIG. 6

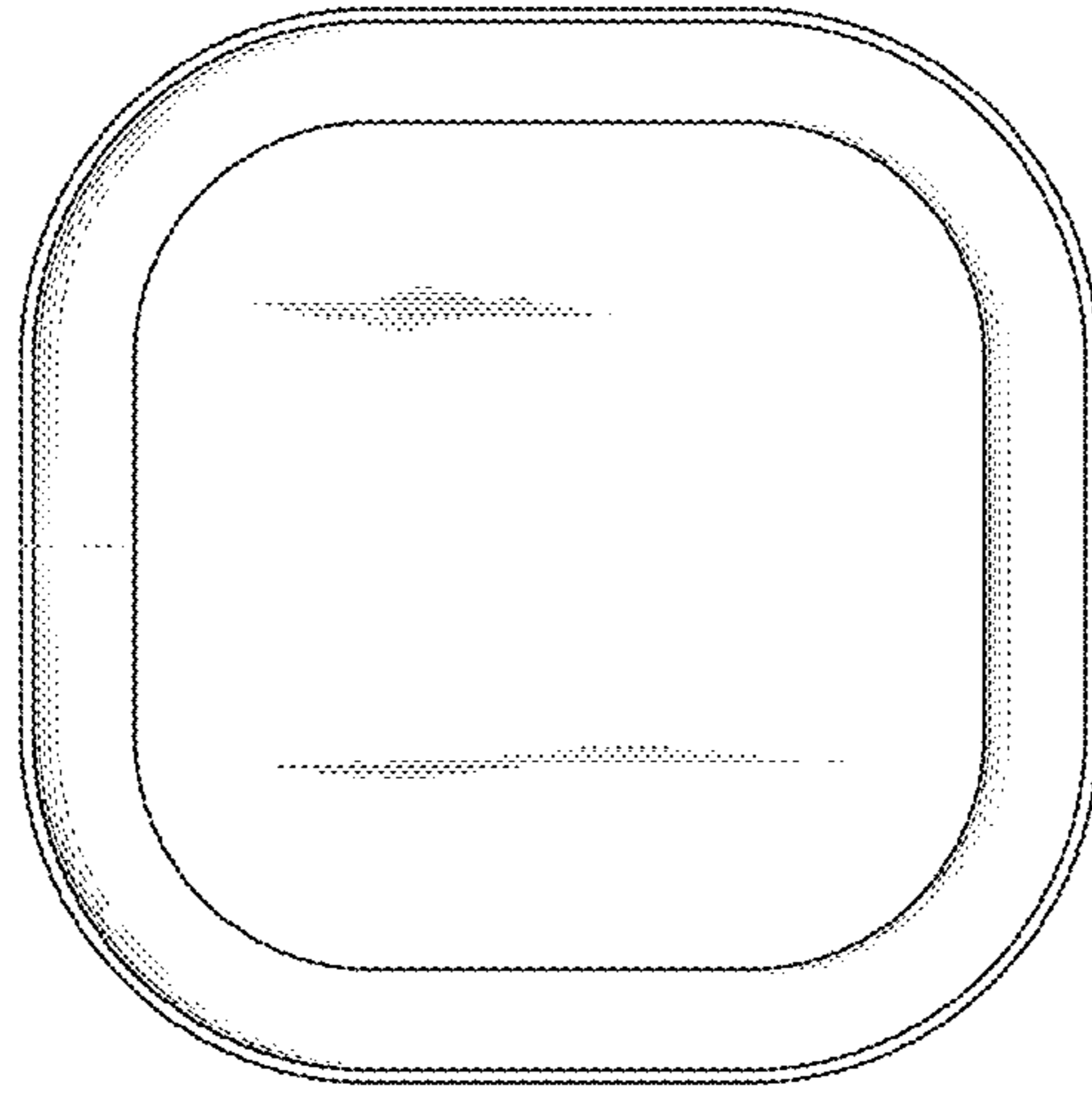

FIG. 7

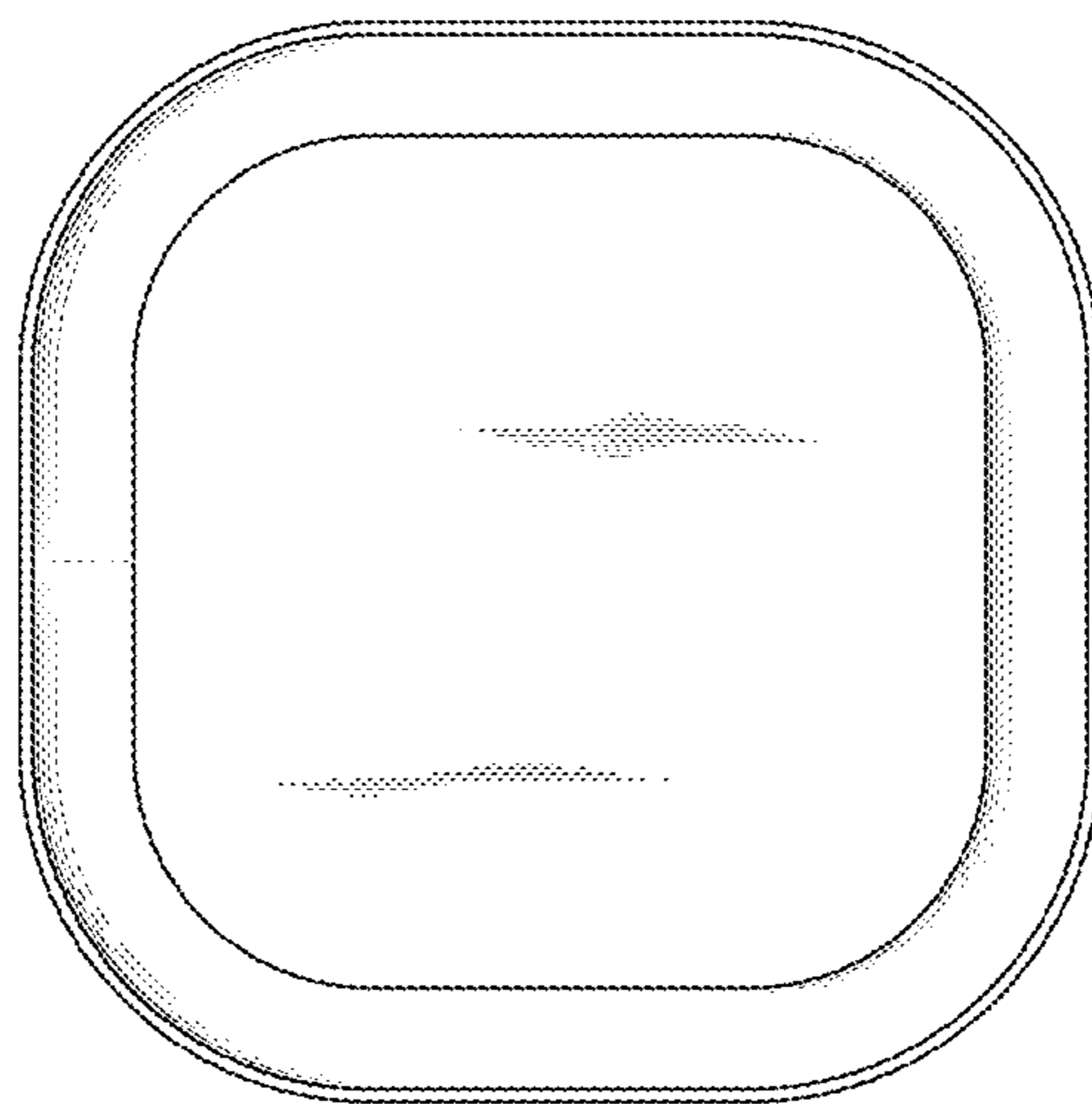

FIG. 8

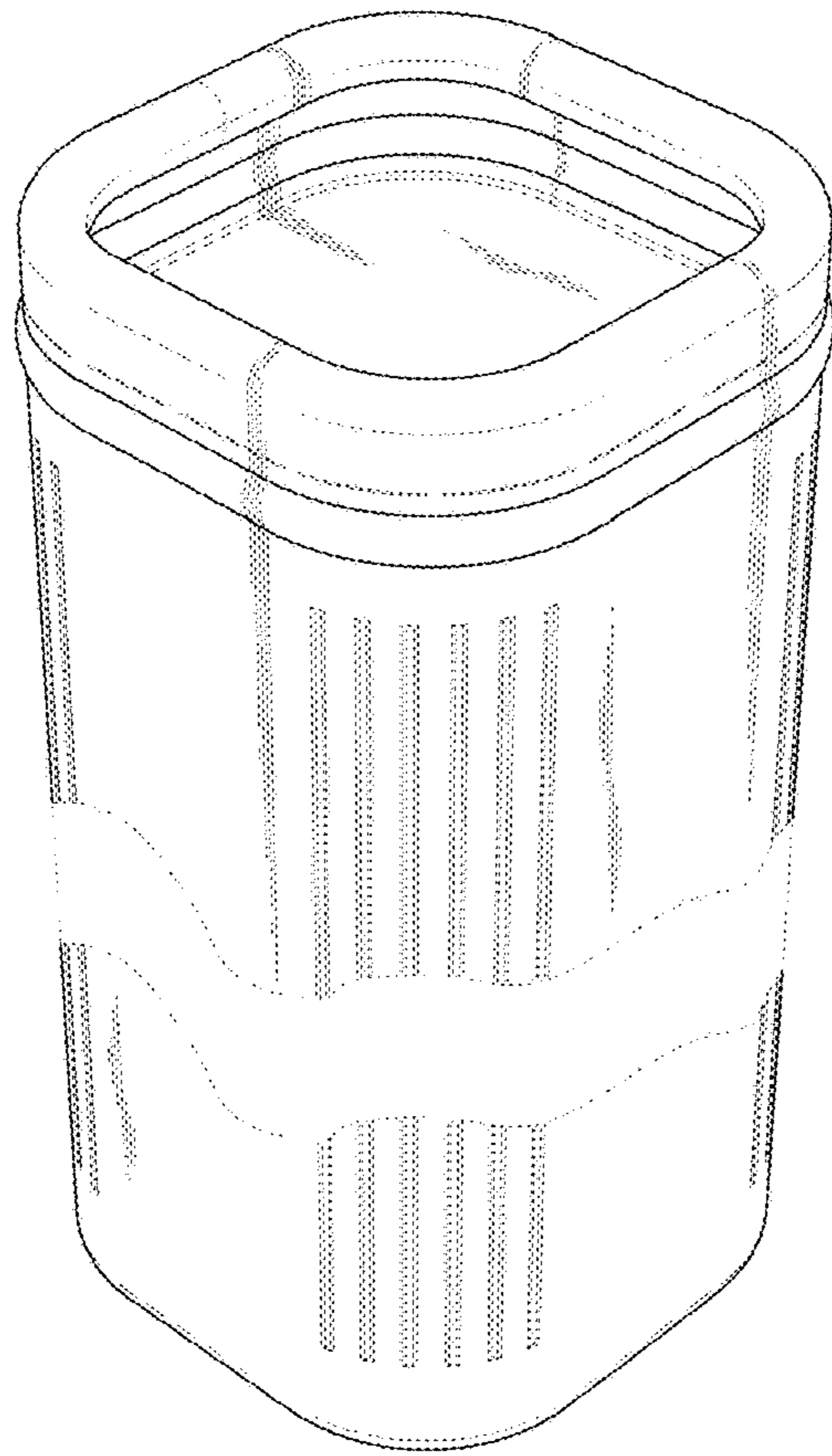

FIG. 9

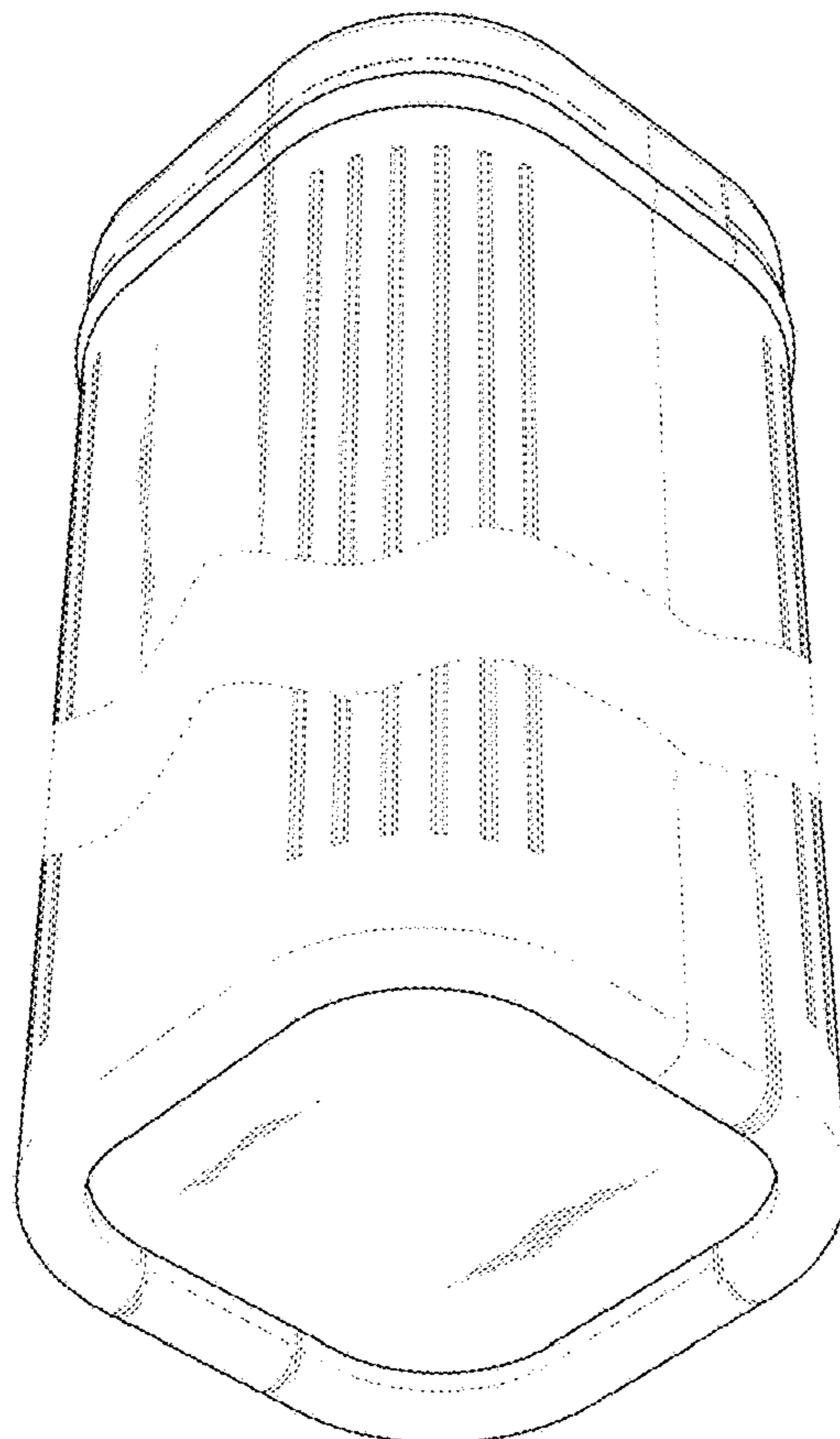

FIG. 10

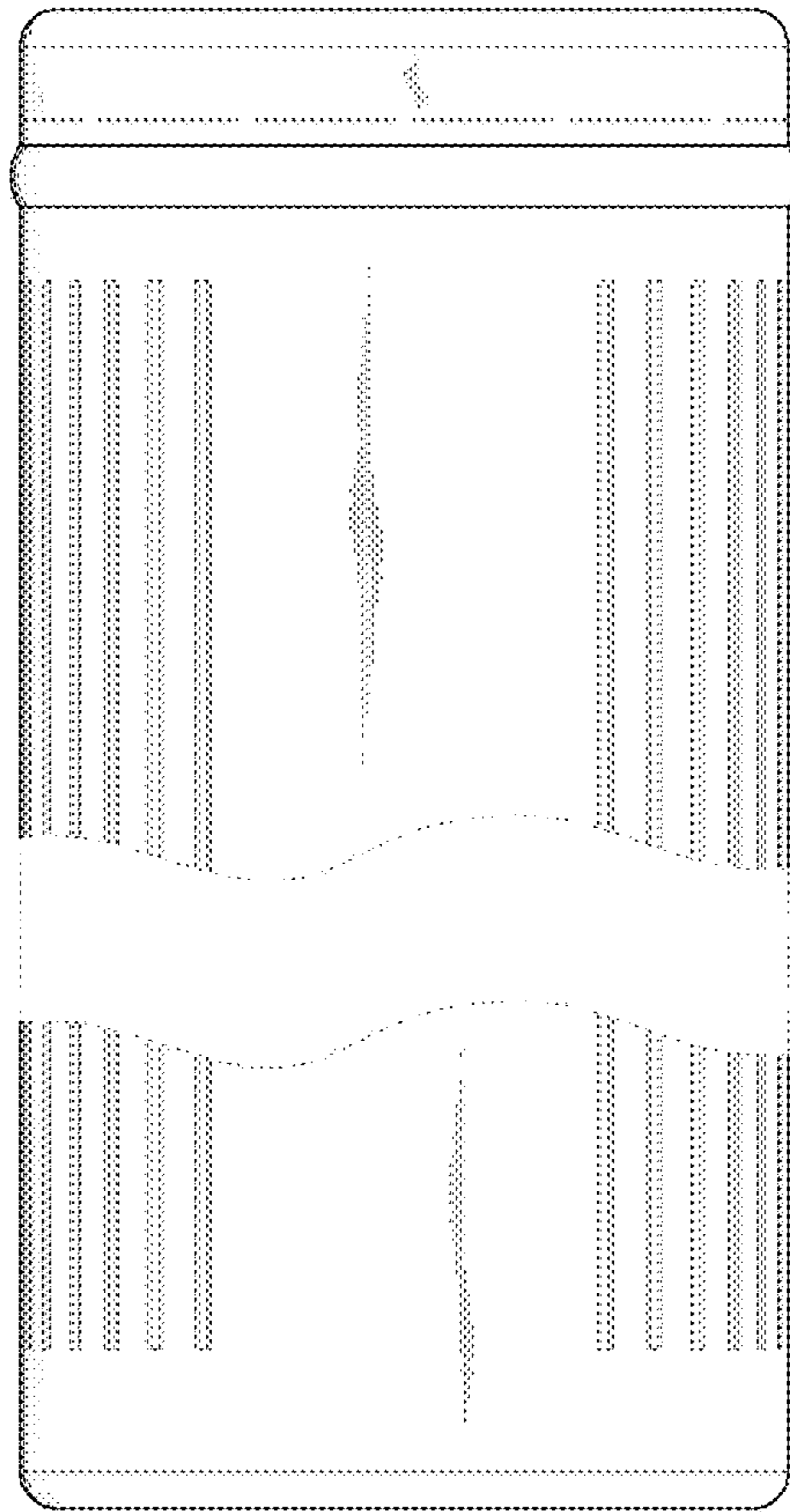

FIG. 11

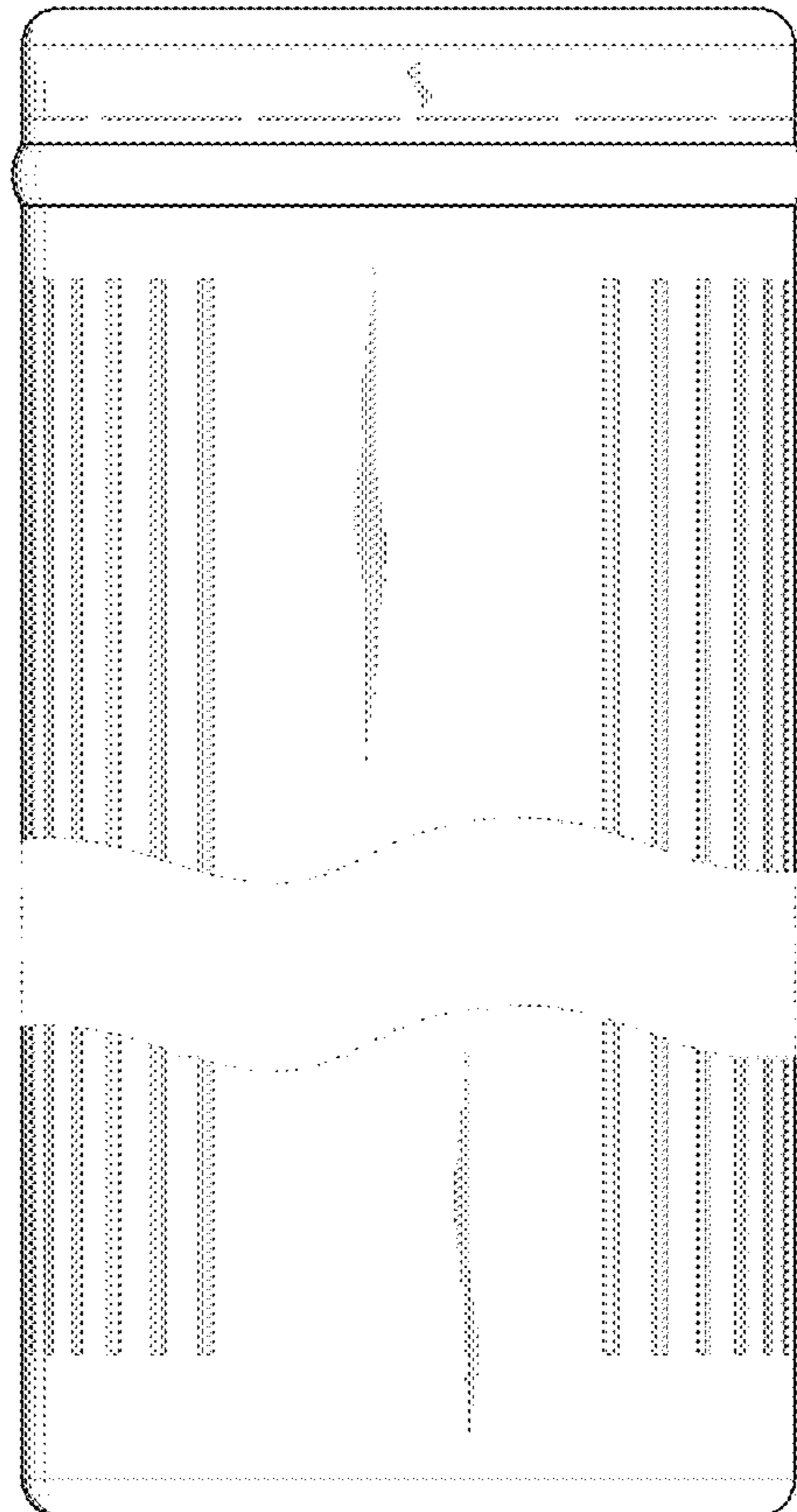

FIG. 12

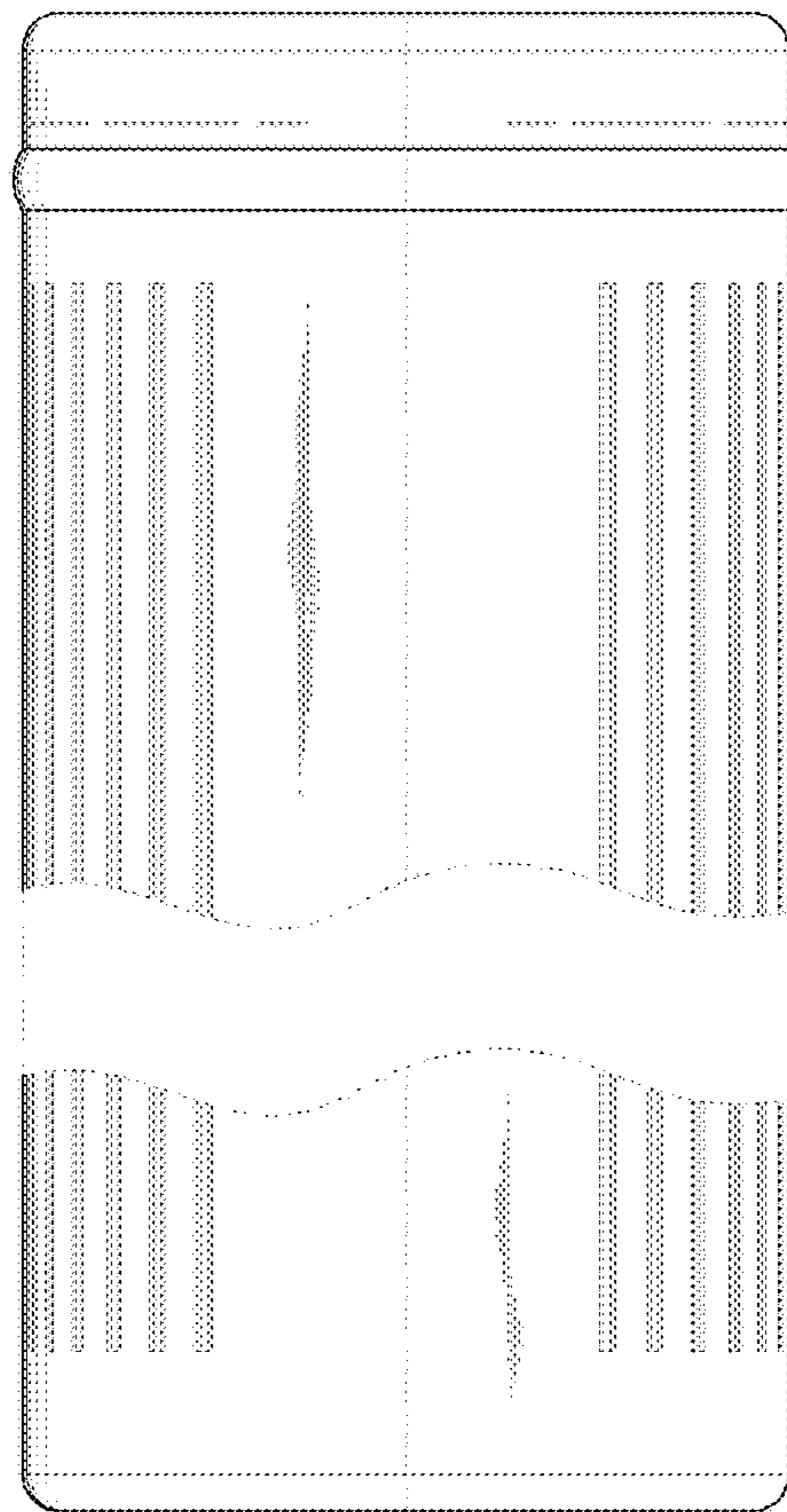

FIG. 13

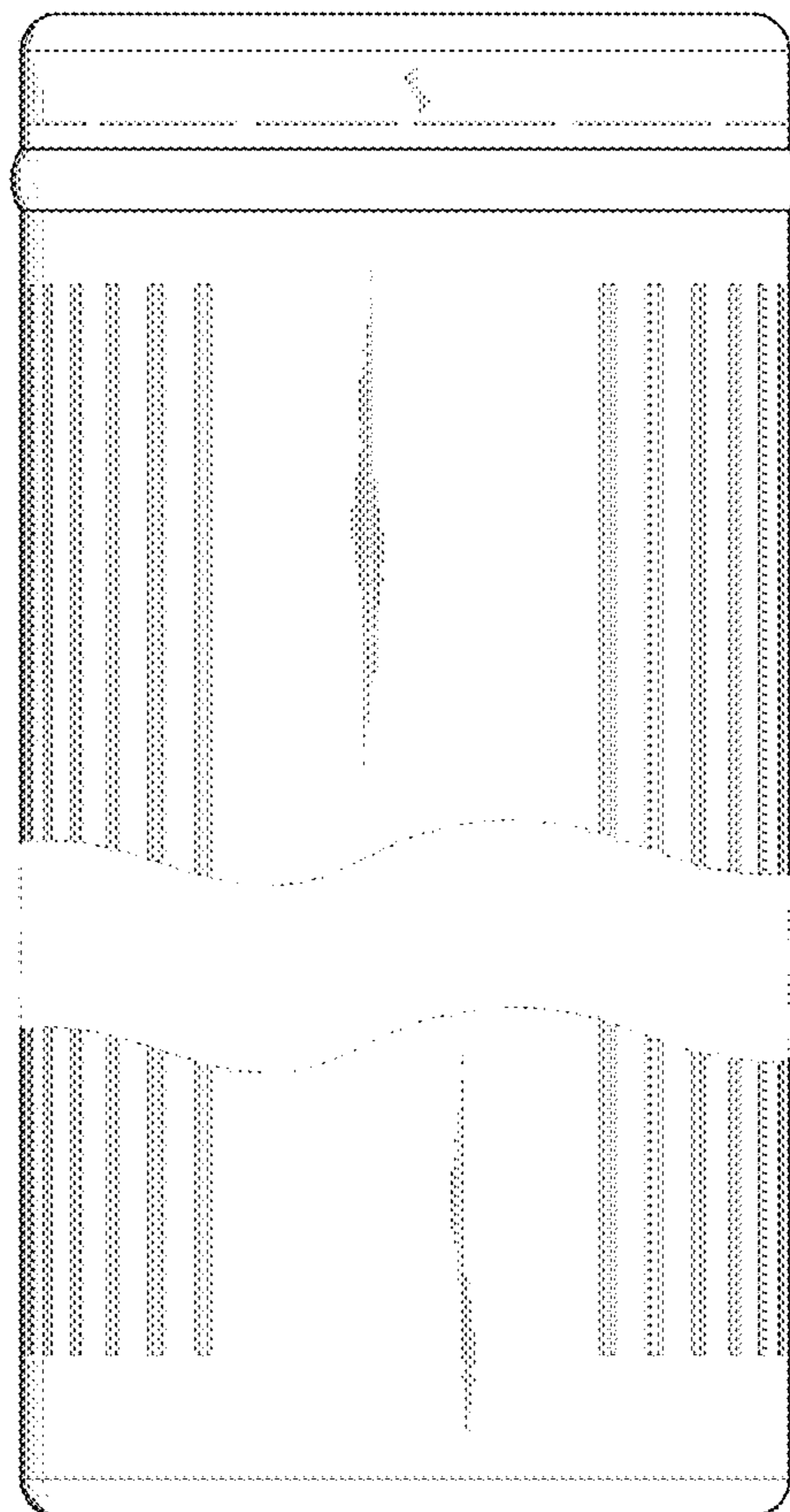

FIG. 14

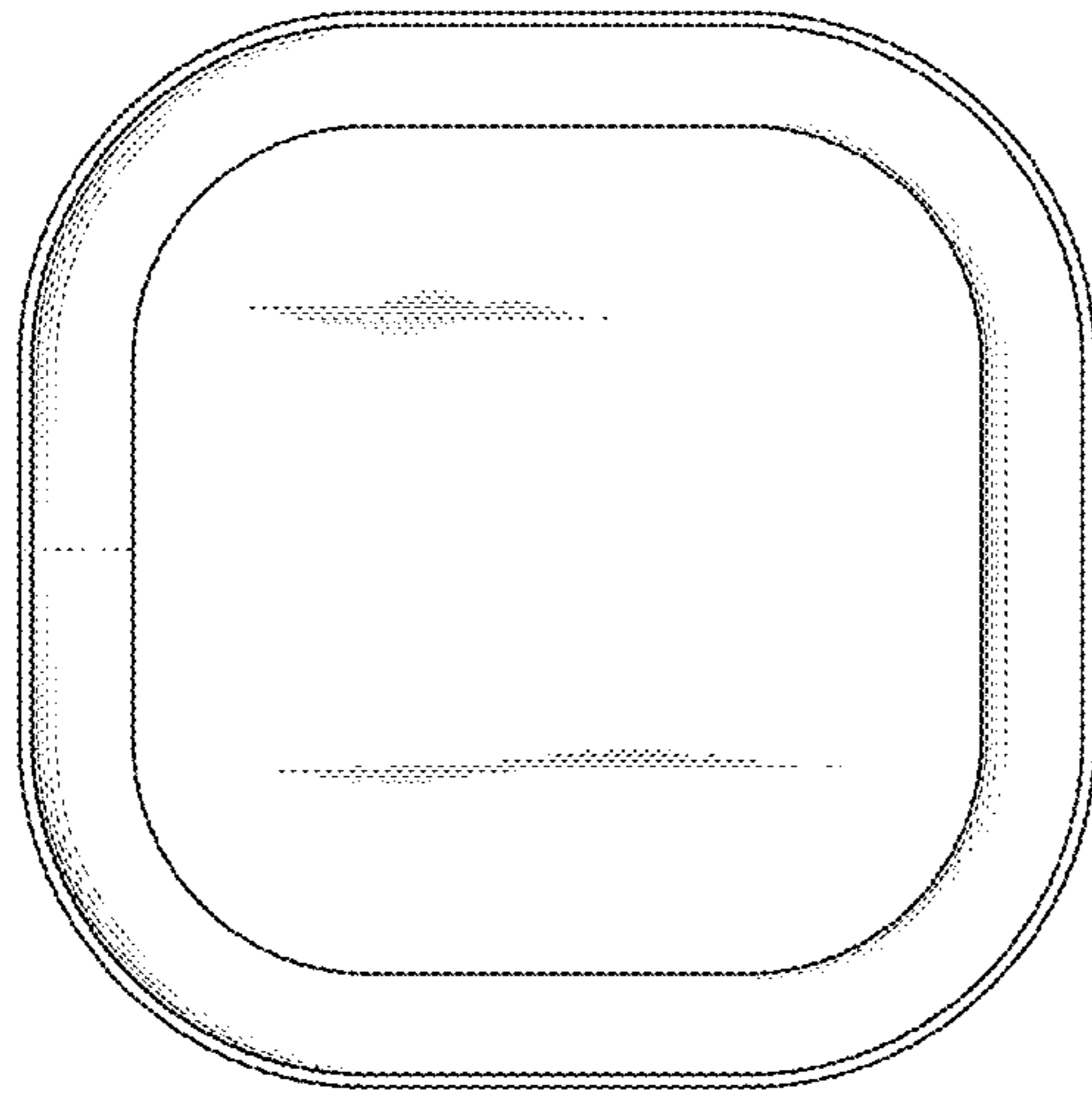

FIG. 15

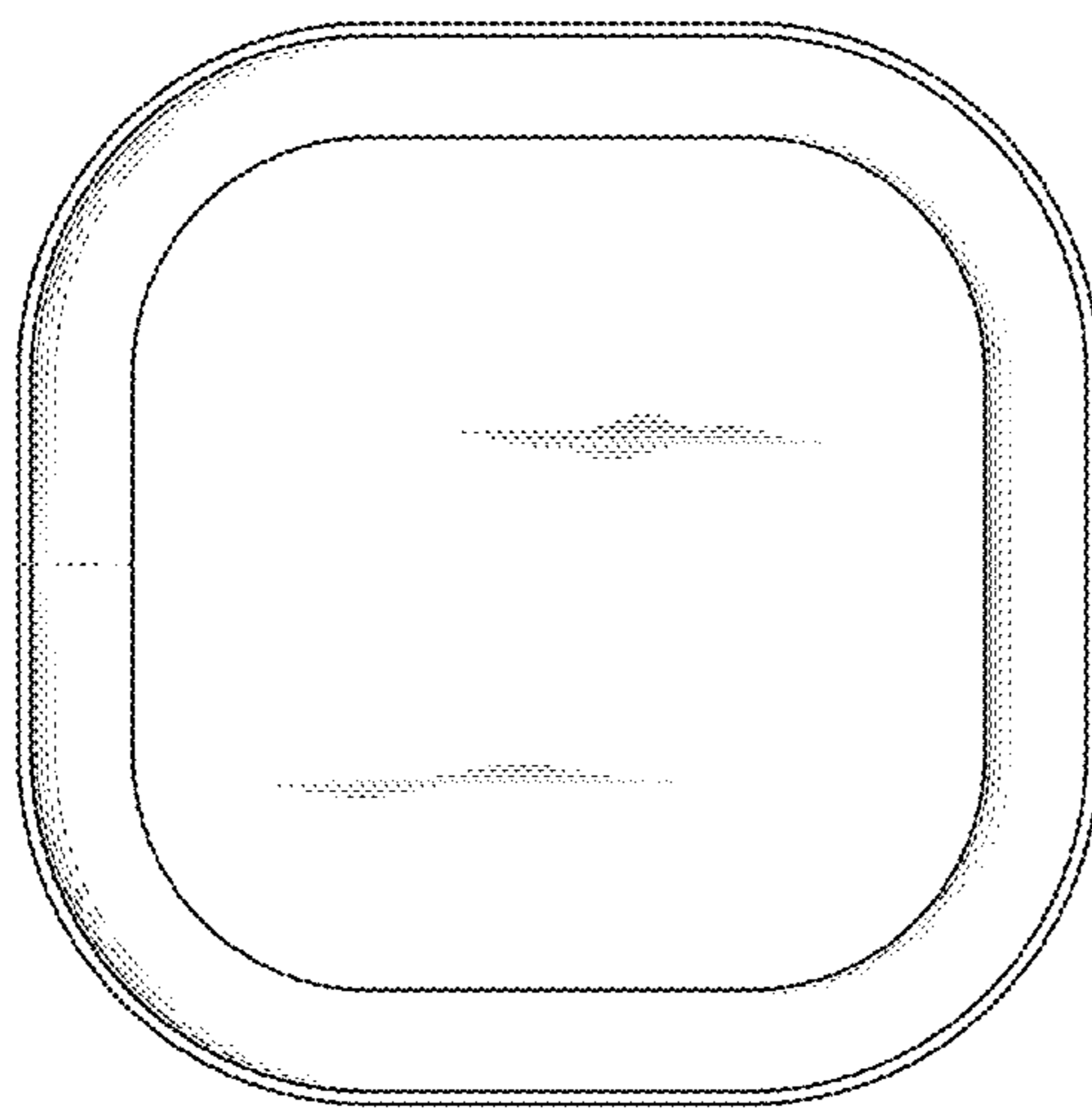

FIG. 16