

US00D966097S

(12) **United States Design Patent**
Diep

(10) **Patent No.:** **US D966,097 S**

(45) **Date of Patent:** **** Oct. 11, 2022**

(54) **JAR WITH ELONGATED CLOSURE**

(71) Applicant: **ND Supplies Inc.**, Richmond (CA)

(72) Inventor: **Manh Linh Diep**, Richmond (CA)

(**) Term: **15 Years**

(21) Appl. No.: **35/512,000**

(22) Filed: **Apr. 1, 2021**

(80) **Hague Agreement Data**

Int. Filing Date: **Apr. 1, 2021**

Int. Reg. No.: **DM/214585**

Int. Reg. Date: **Apr. 1, 2021**

Int. Reg. Pub. Date: **Jun. 11, 2021**

(51) **LOC (13) Cl.** **09-03**

(52) **U.S. Cl.**
USPC **D9/428; D9/432**

(58) **Field of Classification Search**
USPC D9/414, 422, 426, 428, 432
CPC B65D 2543/00296; B65D 2543/00092;
B65D 2543/00194; B65D 2543/0012;
B65D 2251/1058; B65D 2251/1091
See application file for complete search history.

(56) **References Cited**

U.S. PATENT DOCUMENTS

- 2,771,184 A * 11/1956 Ryno B65D 81/07
D9/503
- D377,757 S * 2/1997 Bertolini D9/503
- D640,569 S * 6/2011 Alongi D9/503

- D741,593 S * 10/2015 Brown D3/202
- D806,475 S * 1/2018 Pisarevsky D9/503
- D844,435 S * 4/2019 Deylamian D9/503
- D920,621 S * 5/2021 Clavé D99/5
- 2019/0161249 A1* 5/2019 Goldfarb B65D 43/0229

* cited by examiner

Primary Examiner — Michael A. Pratt

(74) *Attorney, Agent, or Firm* — Seed IP Law Group LLP

(57) **CLAIM**

The ornamental design for a jar with elongated closure, as shown and described.

DESCRIPTION

1. Jar with elongated closure
2. Jar with elongated closure
 - 1.1 perspective view
 - 1.2 perspective view
 - 1.3 front elevation view
 - 1.4. Rear elevation view
 - 1.5. side elevation view
 - 1.6 top plan view
 - 1.7 bottom plan view; circular design
- 2.1 perspective view
- 2.2 perspective view
- 2.3 front elevation view
- 2.4 side elevation view
- 2.5 bottom plan view
- 2.6 top plan view

The broken line showing of a twist lock is for the purpose of illustrating portions of the jar with elongated closure and forms no part of the claimed design.

1 Claim, 13 Drawing Sheets

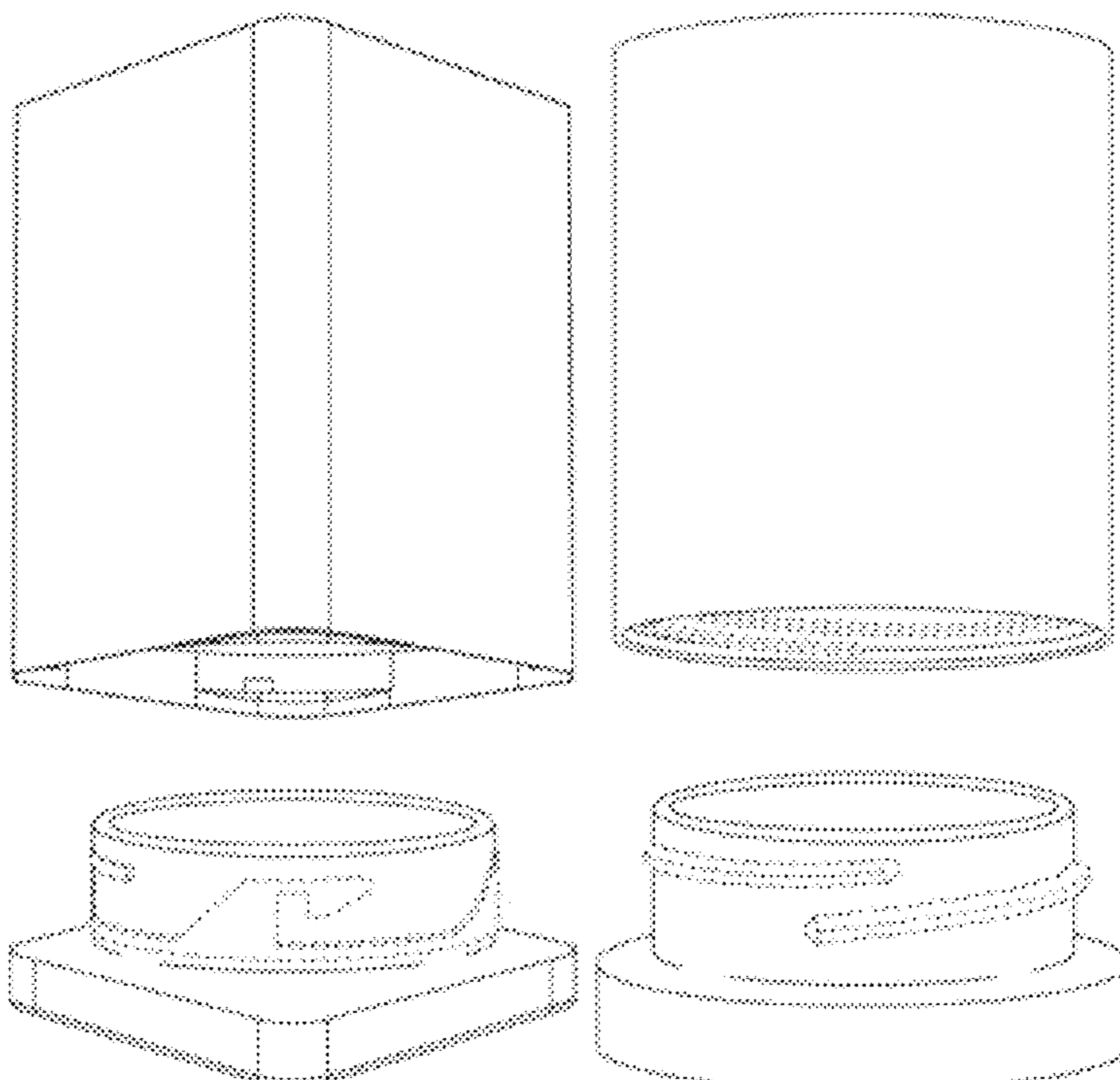

1.1

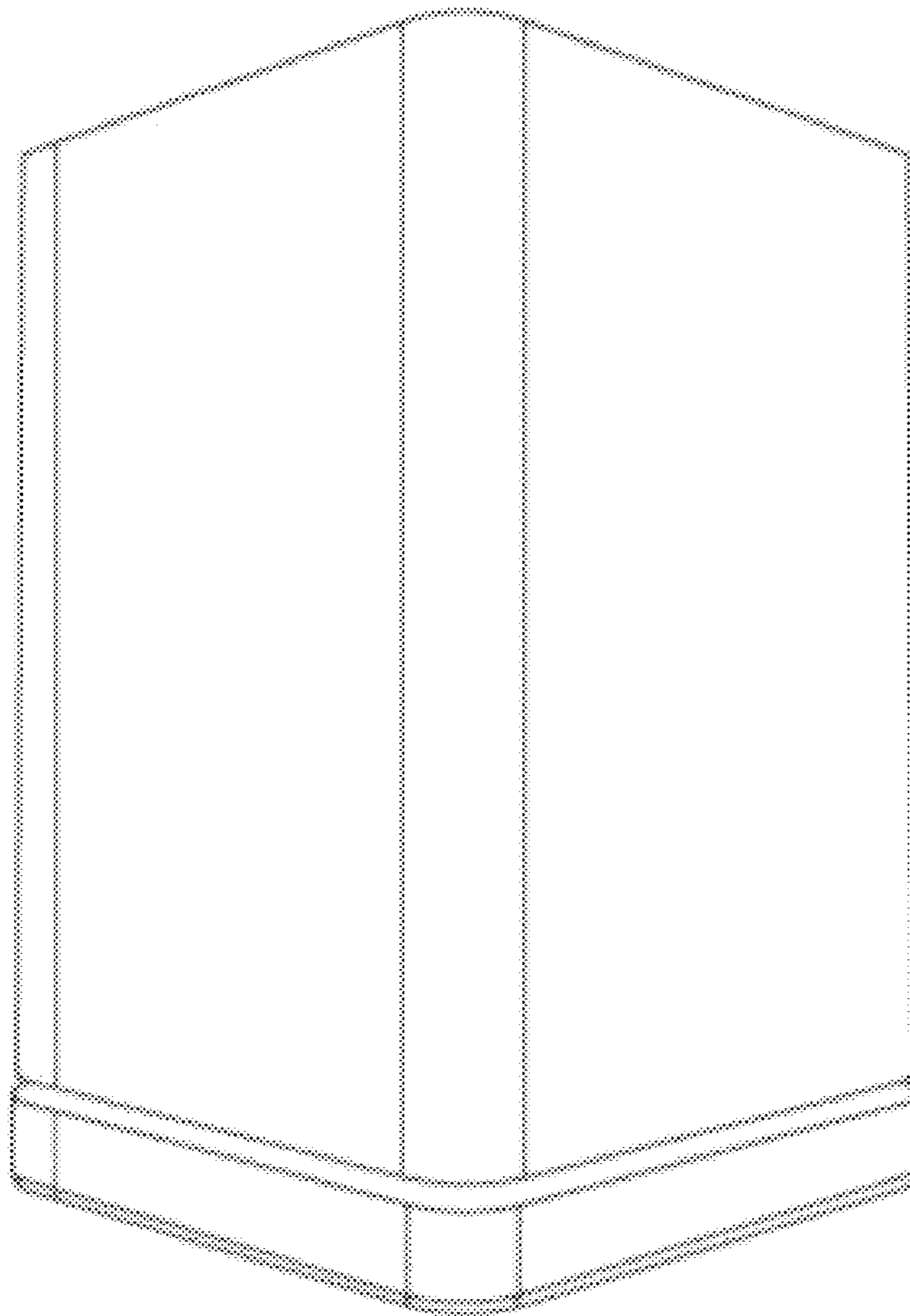

1.2

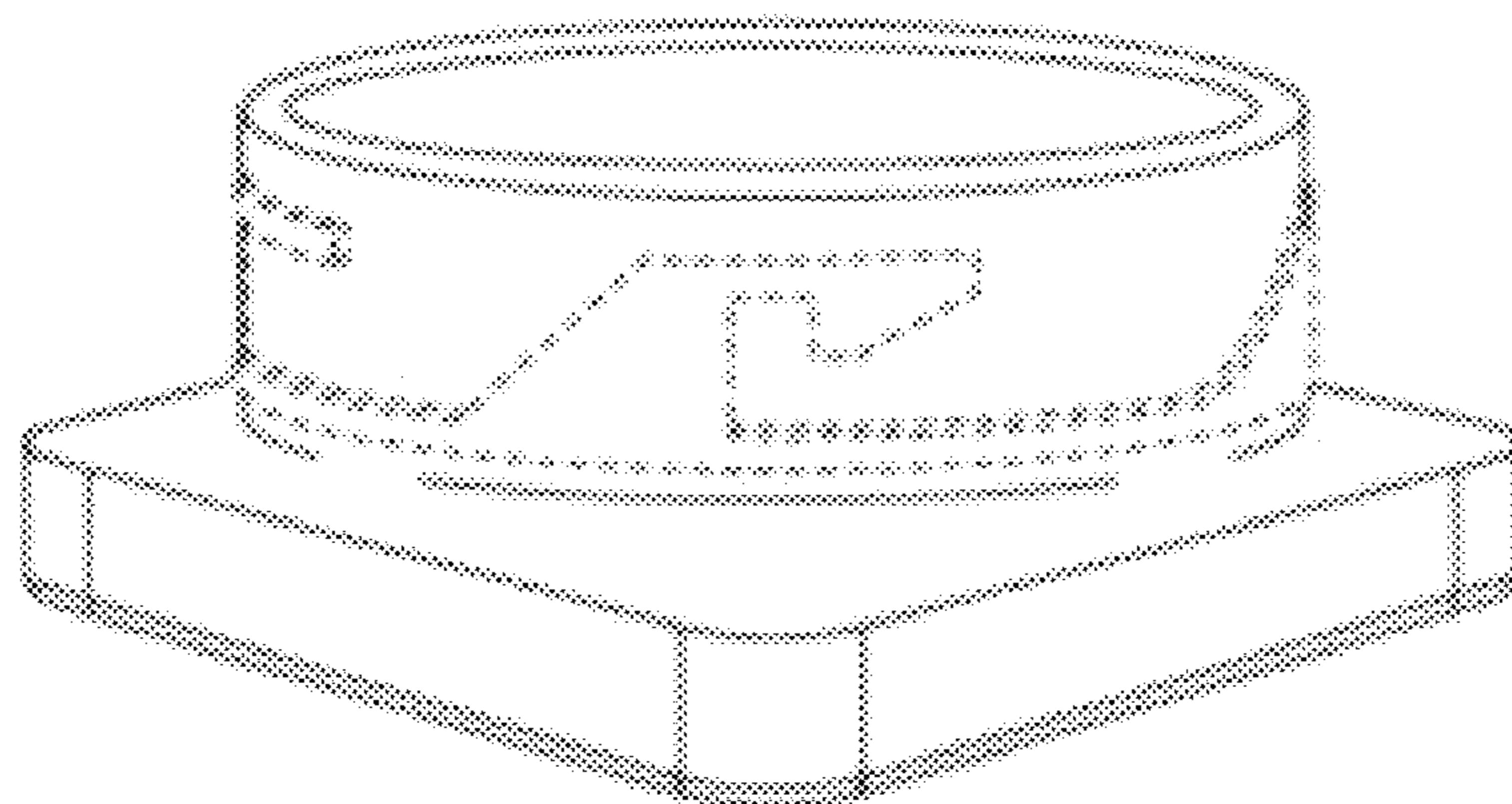
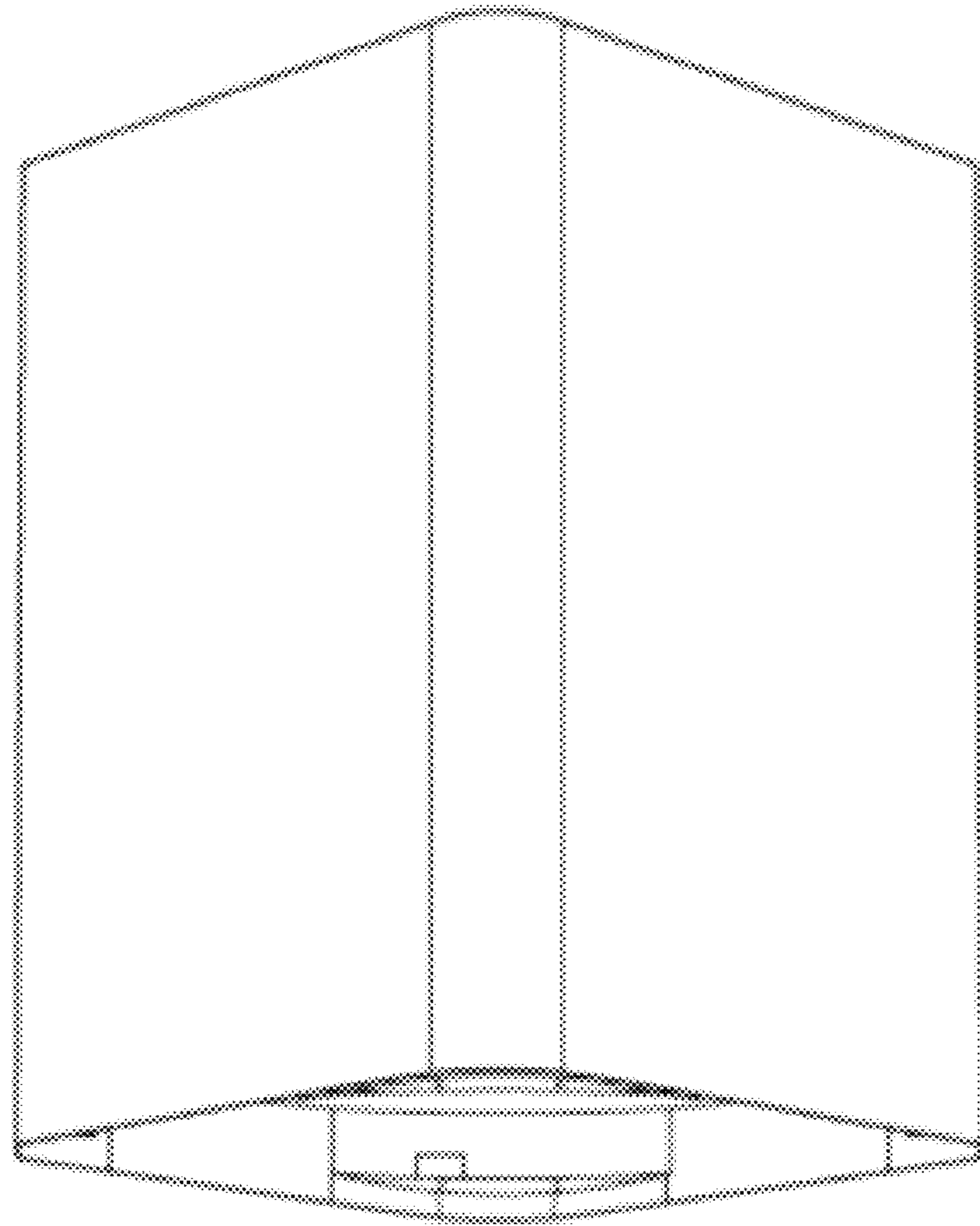

1.3

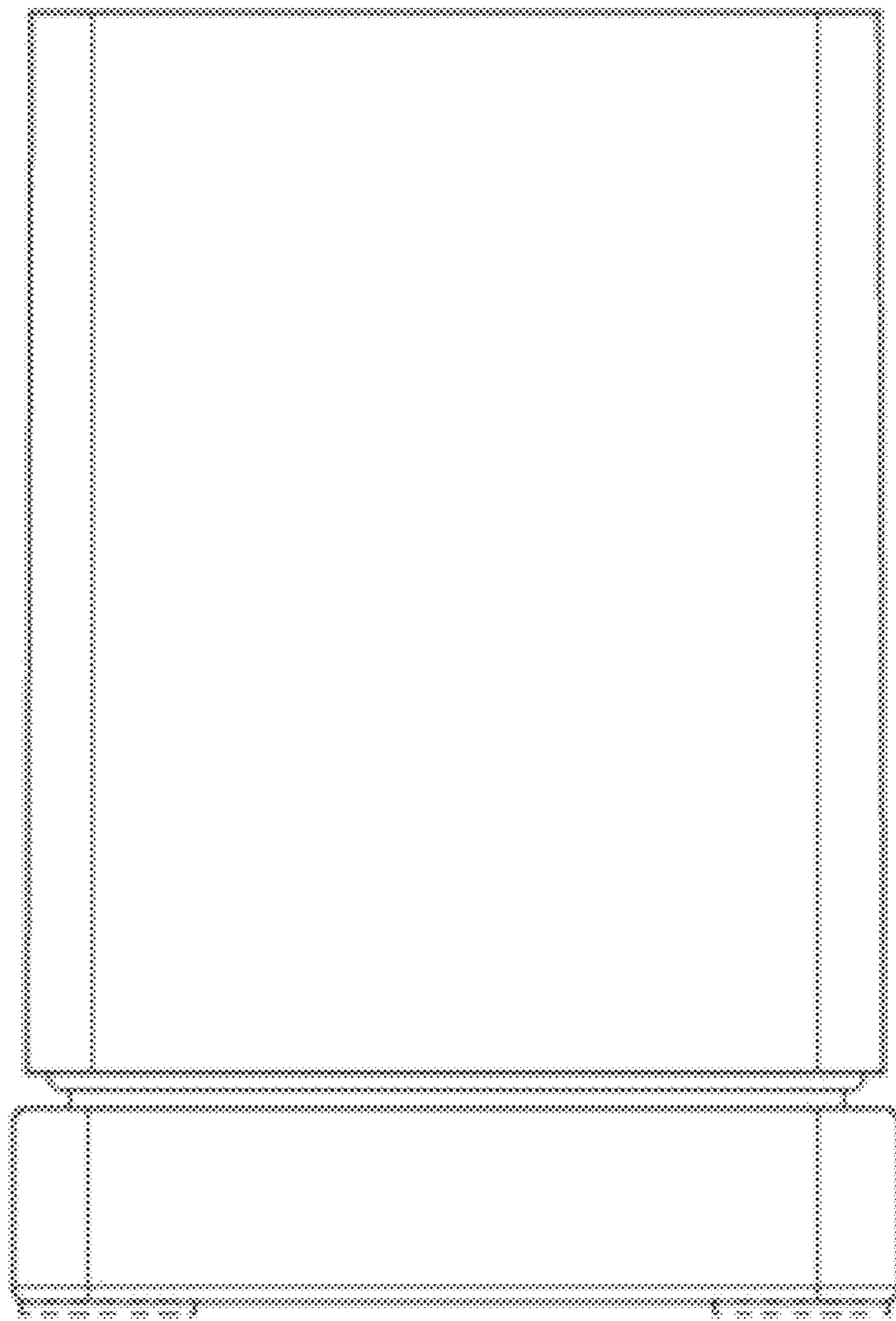

1.4

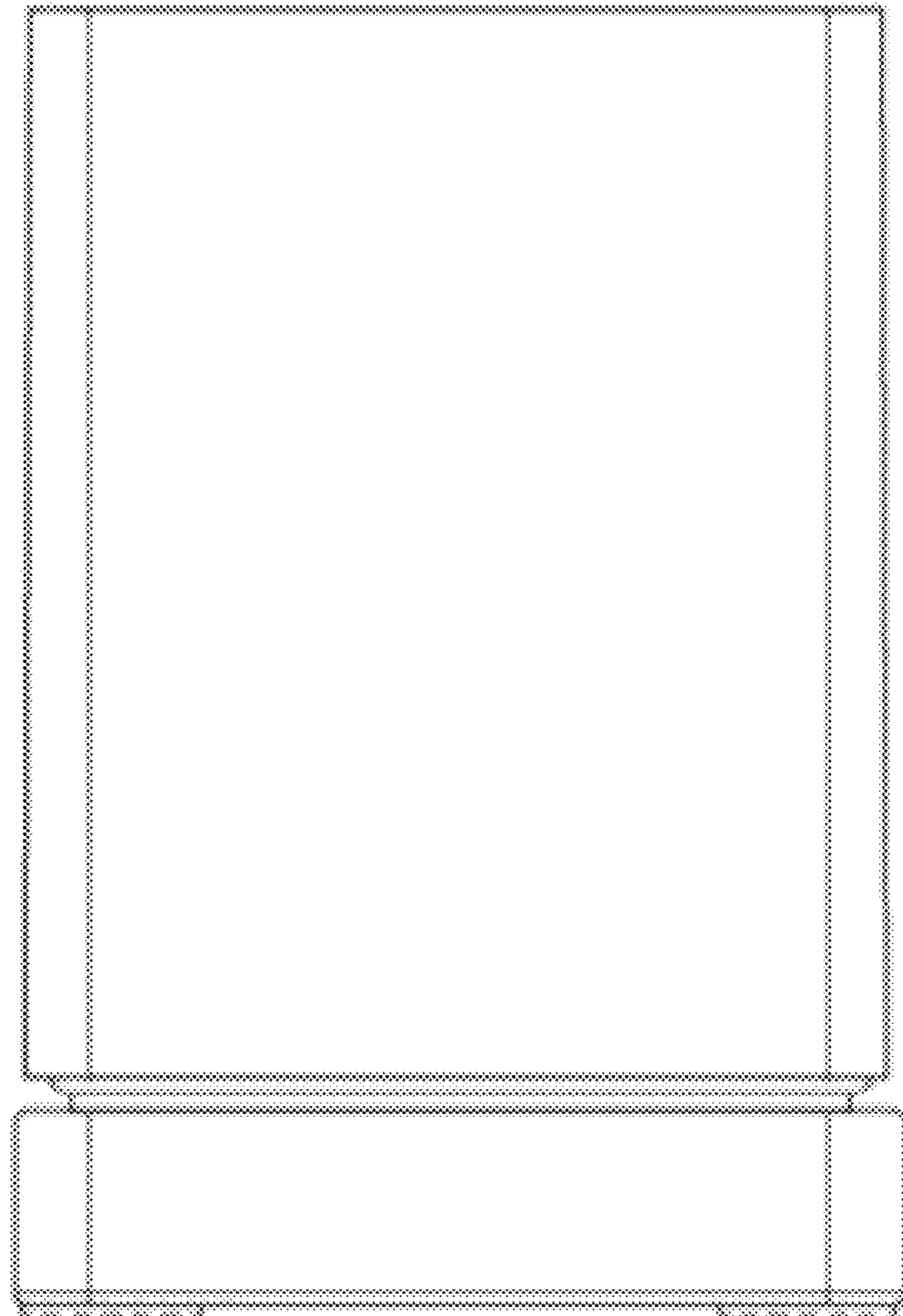

1.5

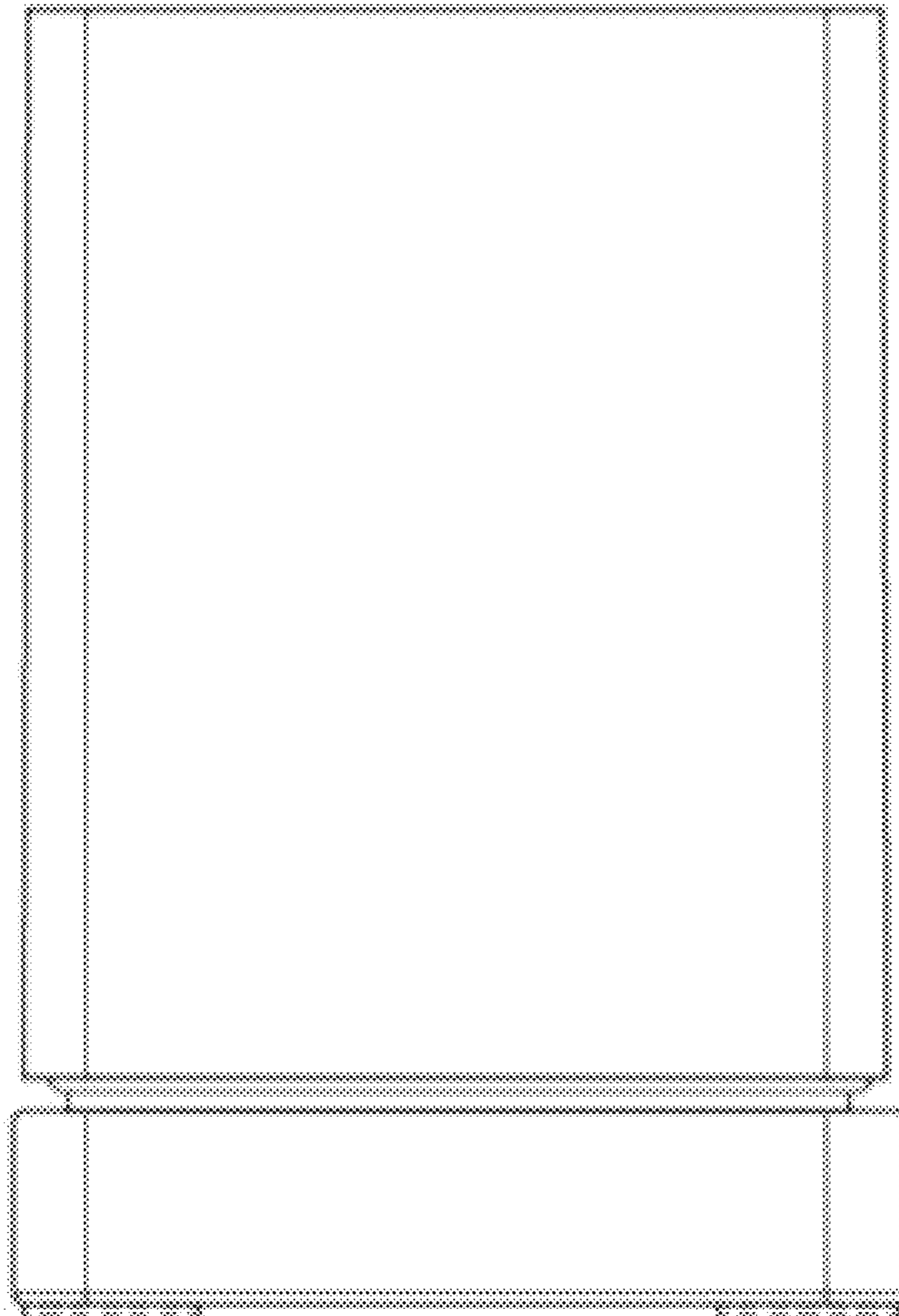

1.6

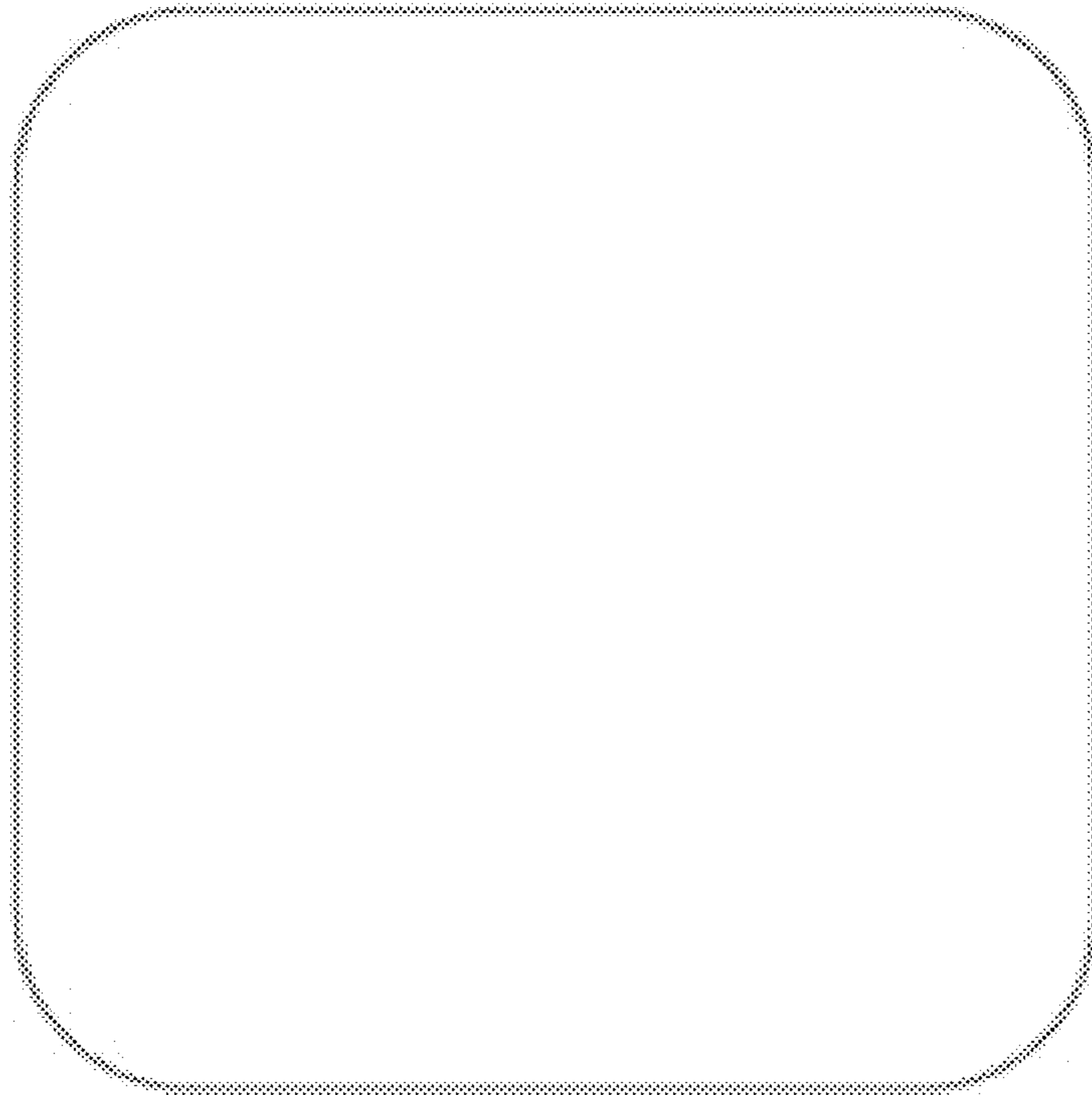

1.7

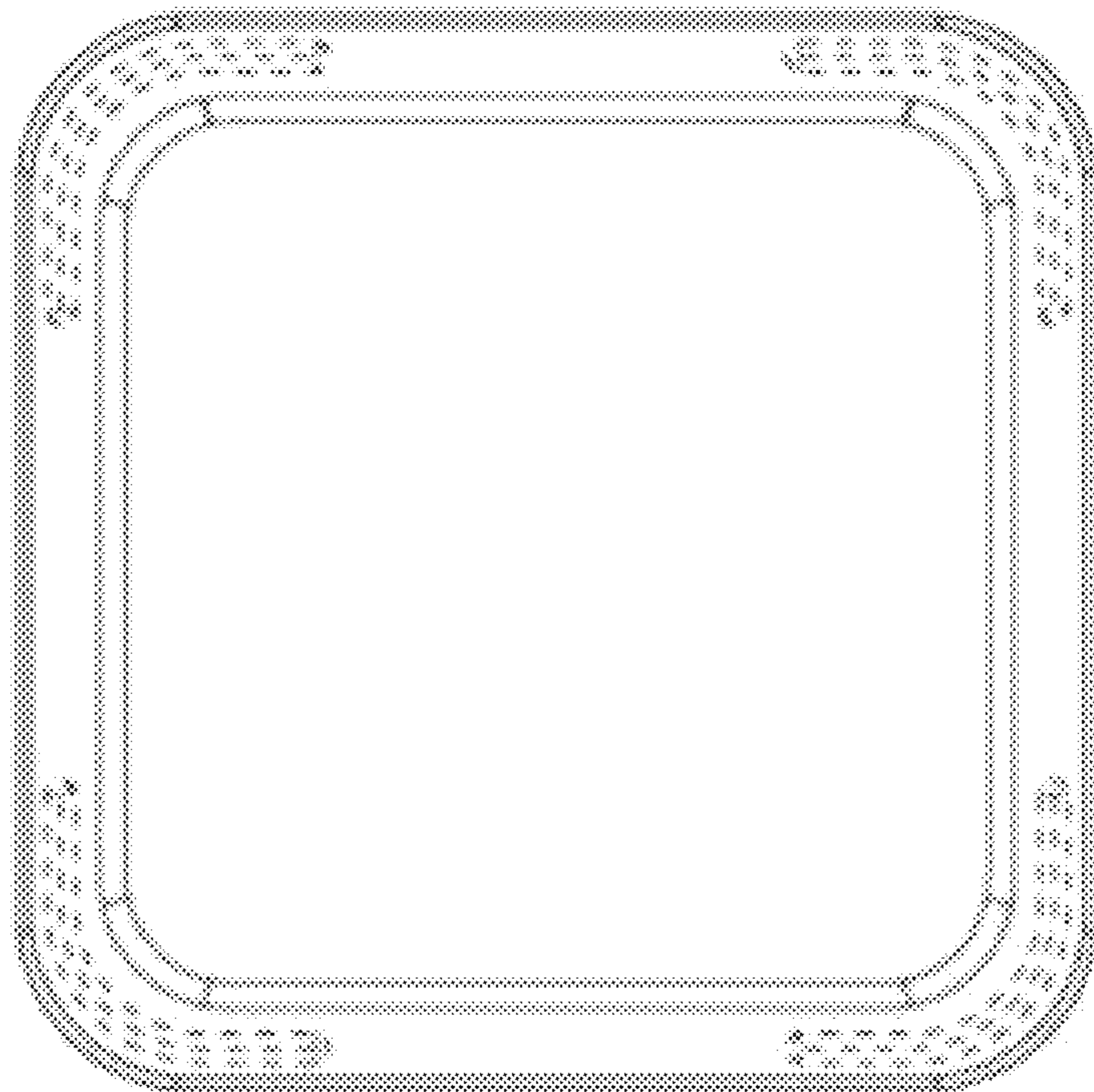

2.1

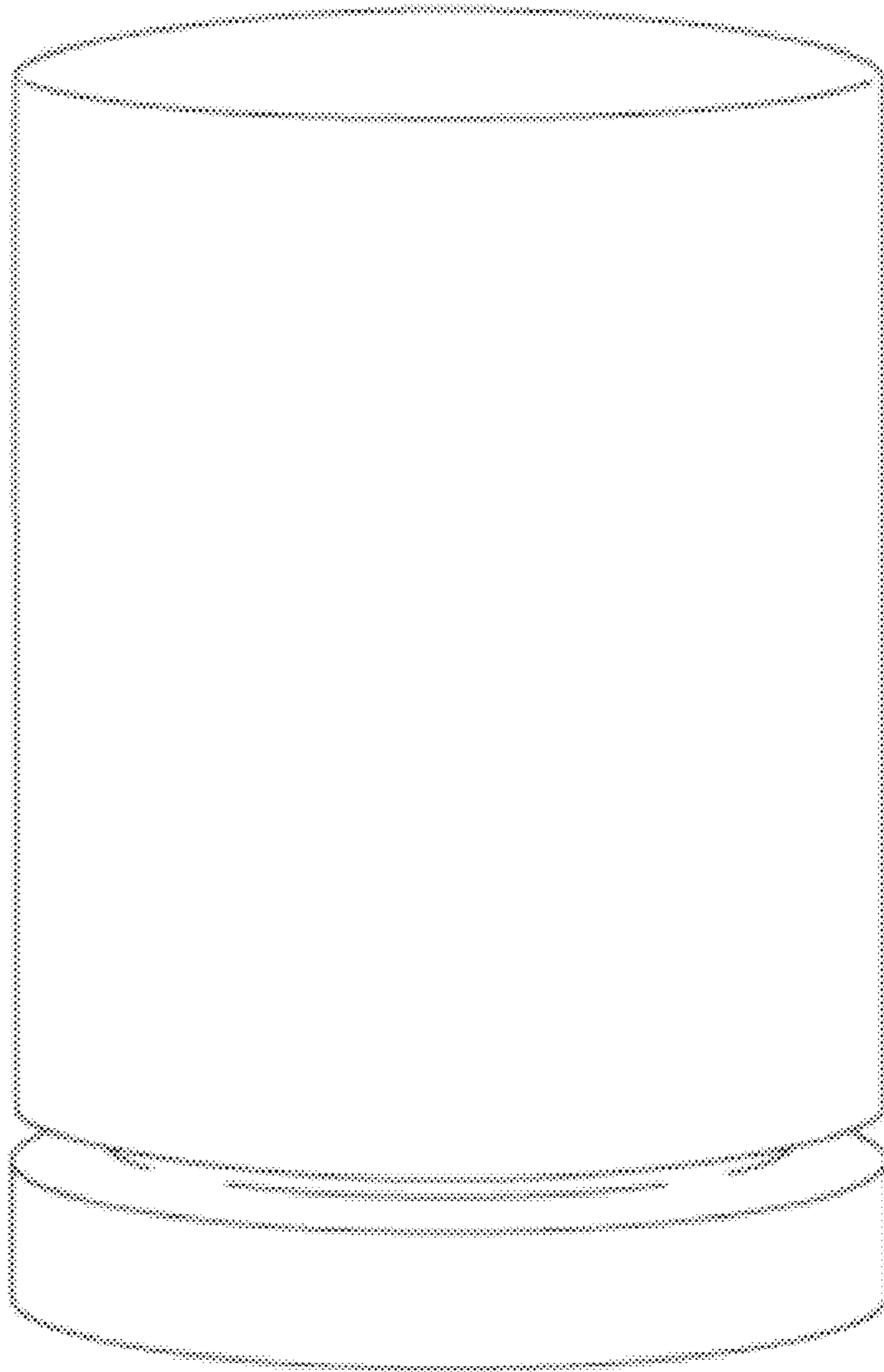

2.2

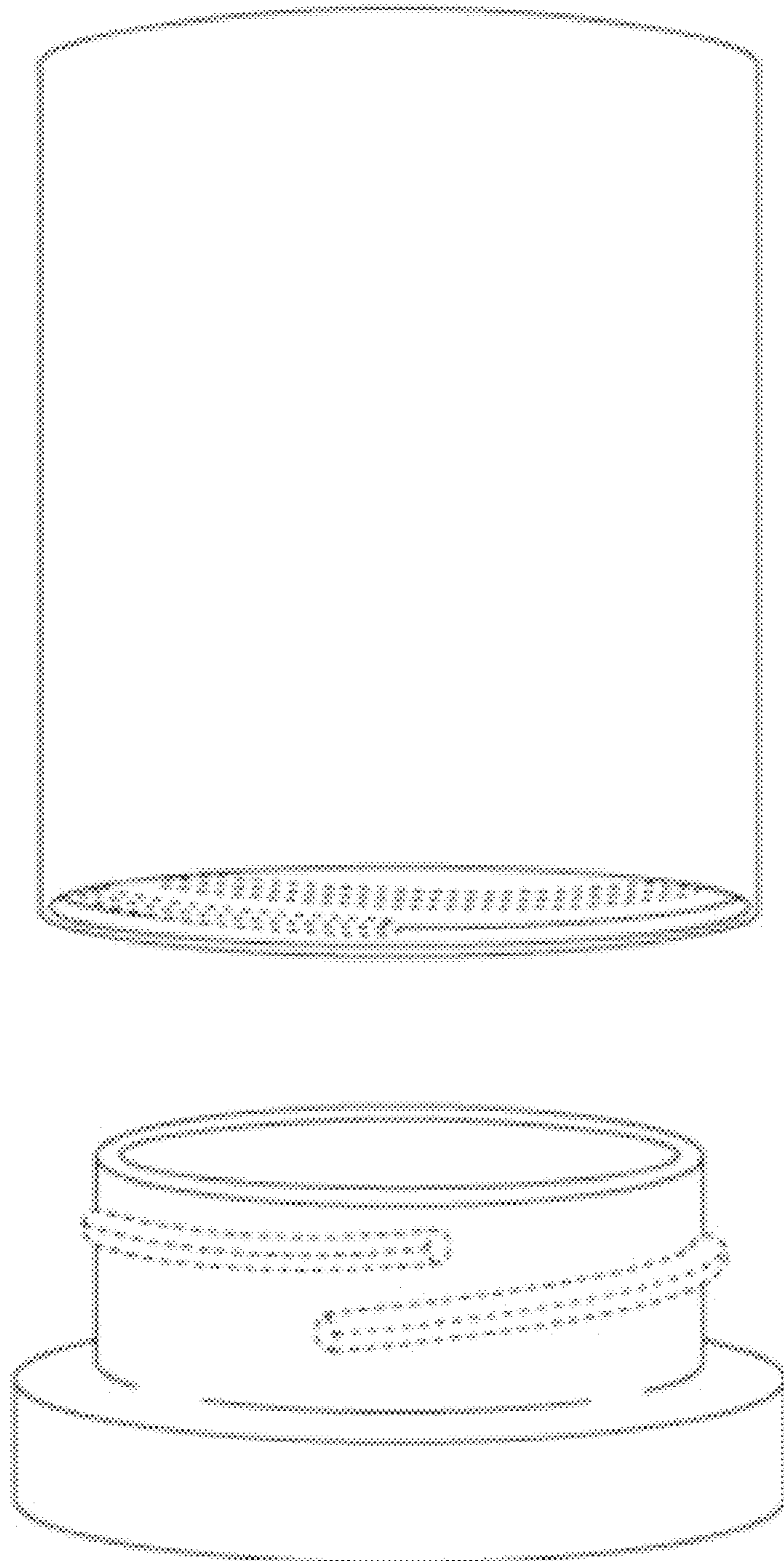

2.3

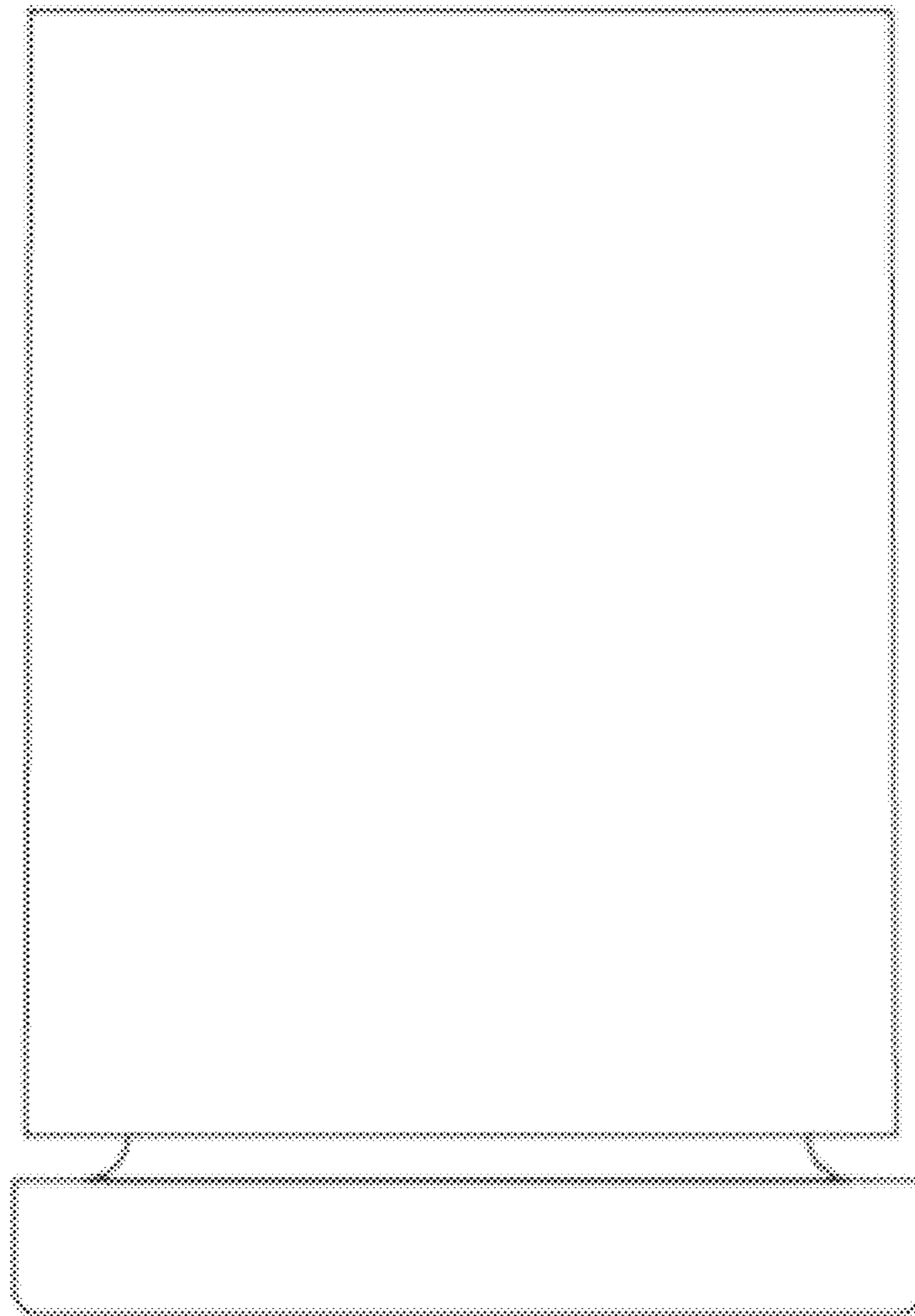

2.4

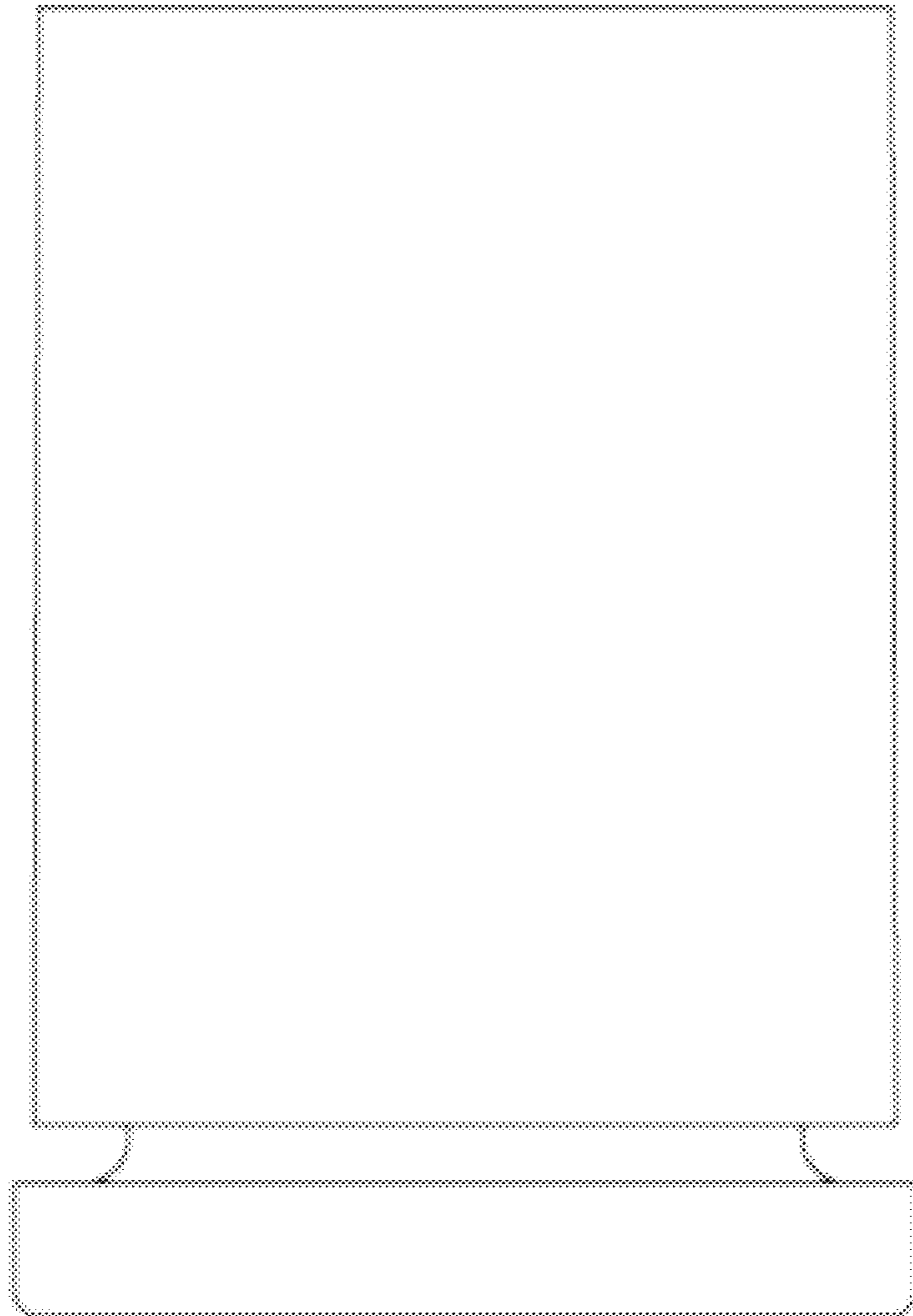

2.5

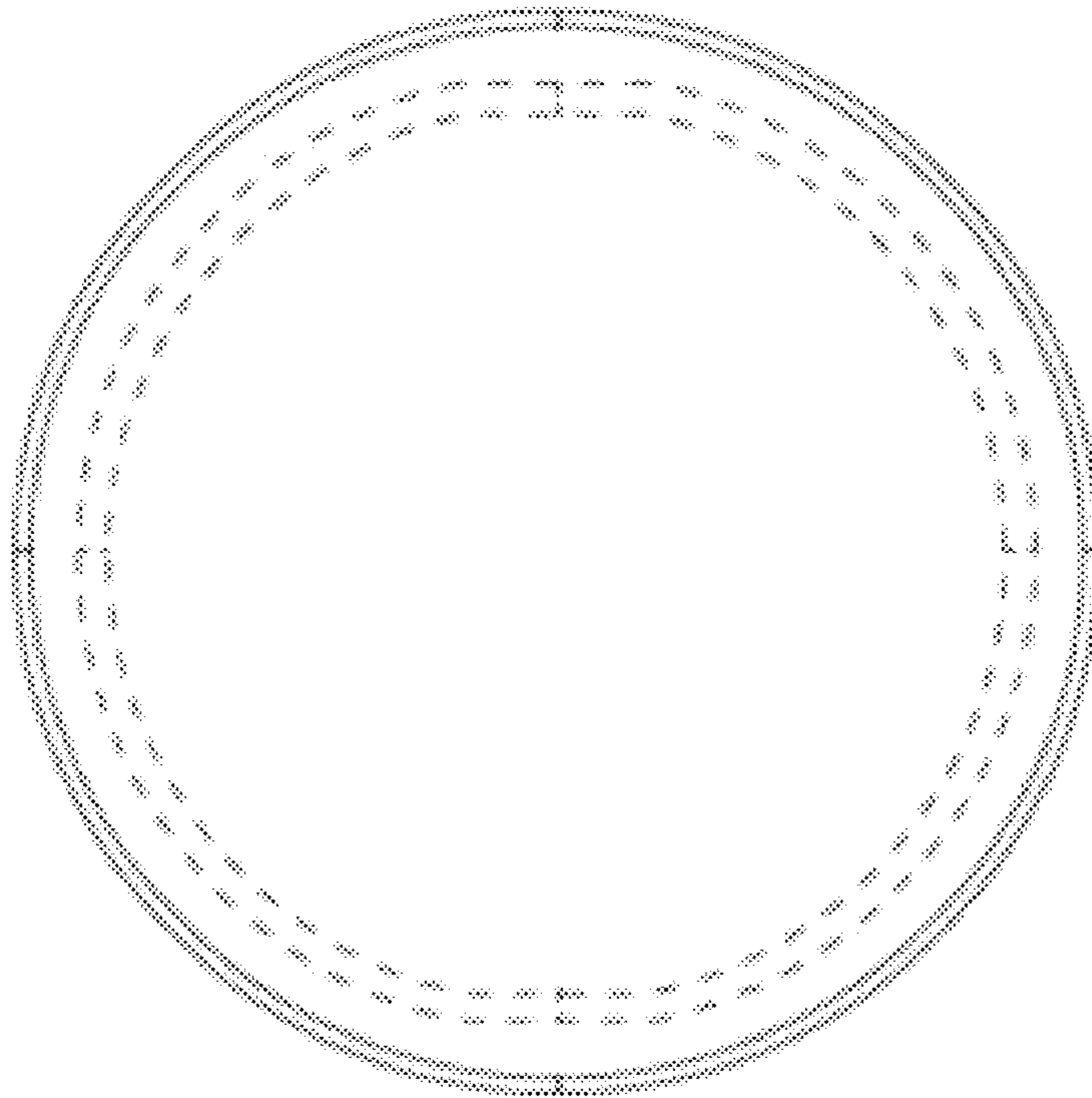

2.6

