



US00D966086S

(12) **United States Design Patent** (10) **Patent No.:** **US D966,086 S**  
**Baldauf et al.** (45) **Date of Patent:** **\*\* Oct. 11, 2022**

(54) **BLISTER PACKAGE**  
(71) Applicant: **3M INNOVATIVE PROPERTIES COMPANY**, St. Paul, MN (US)  
(72) Inventors: **Chelsy E. Baldauf**, Minneapolis, MN (US); **Monica J. Draveling**, Hudson, WI (US); **Alexandra K. Focke**, Charlotte, NC (US); **Margaret M. Bonello**, Minneapolis, MN (US); **Anthony E. Shidla**, Minneapolis, MN (US)  
(73) Assignee: **3M Innovative Properties Company**, St. Paul, MN (US)

D308,485 S \* 6/1990 Yeske ..... D9/415  
D316,669 S \* 5/1991 Young ..... D9/418  
D327,426 S \* 6/1992 Karita ..... D9/415  
D370,174 S \* 5/1996 Bergstedt ..... D9/415  
D373,307 S \* 9/1996 Menaged ..... D9/415  
D421,899 S \* 3/2000 Eneroth ..... D9/732  
D429,149 S \* 8/2000 Humphrey ..... D9/418  
D430,016 S \* 8/2000 Pirro ..... D9/415  
D432,010 S \* 10/2000 Etzel ..... D9/415  
D434,654 S \* 12/2000 McCool ..... D9/415  
D448,284 S \* 9/2001 Stanford ..... D9/415  
D449,780 S \* 10/2001 Corella ..... D9/415  
D451,016 S \* 11/2001 Dittmar ..... D9/415  
D456,249 S \* 4/2002 Pearson ..... D9/415  
D463,978 S \* 10/2002 DiMartino ..... D9/418  
D478,510 S \* 8/2003 Kumakura ..... D9/415  
D479,125 S \* 9/2003 Kumakura ..... D9/415

(Continued)

(\*\*) Term: **15 Years**

FOREIGN PATENT DOCUMENTS

(21) Appl. No.: **29/704,506**  
(22) Filed: **Sep. 5, 2019**  
(51) **LOC (13) Cl.** ..... **09-03**  
(52) **U.S. Cl.** ..... **D9/415**  
USPC .....  
(58) **Field of Classification Search**  
USPC ..... D9/414, 415, 416, 418, 424, 425, 428,  
D9/432, 501, 702, 405, 707, 709, 722,  
D9/732, 742, 753, 756, 759; D3/203.4,  
D3/212  
See application file for complete search history.

JP 783887 3/1990  
JP 796190 9/1990

Primary Examiner — Mehri F Bajoul

(57) **CLAIM**

The ornamental design for a blister package, as shown and described.

**DESCRIPTION**

FIG. 1 is a perspective view of a first embodiment of a blister package of the present disclosure;  
FIG. 2 is a front view thereof;  
FIG. 3 is a right side view thereof, with the left side being a mirror image;  
FIG. 4 is a top view thereof;  
FIG. 5 is a bottom view thereof; and,  
FIG. 6 is a rear view thereof.  
The broken lines in FIGS. 1-6, depict a portion of the blister package that forms no part of the claimed design.

(56) **References Cited**

U.S. PATENT DOCUMENTS

D210,355 S \* 3/1968 Lay ..... D9/415  
3,463,308 A \* 8/1969 Deneke ..... B65D 75/36  
D243,443 S \* 2/1977 Hayashi ..... D9/415  
D253,167 S \* 10/1979 Fournier ..... D9/415  
D253,751 S \* 12/1979 Meierhoefer ..... D9/416  
D296,988 S \* 8/1988 Yamada ..... D9/415

**1 Claim, 2 Drawing Sheets**

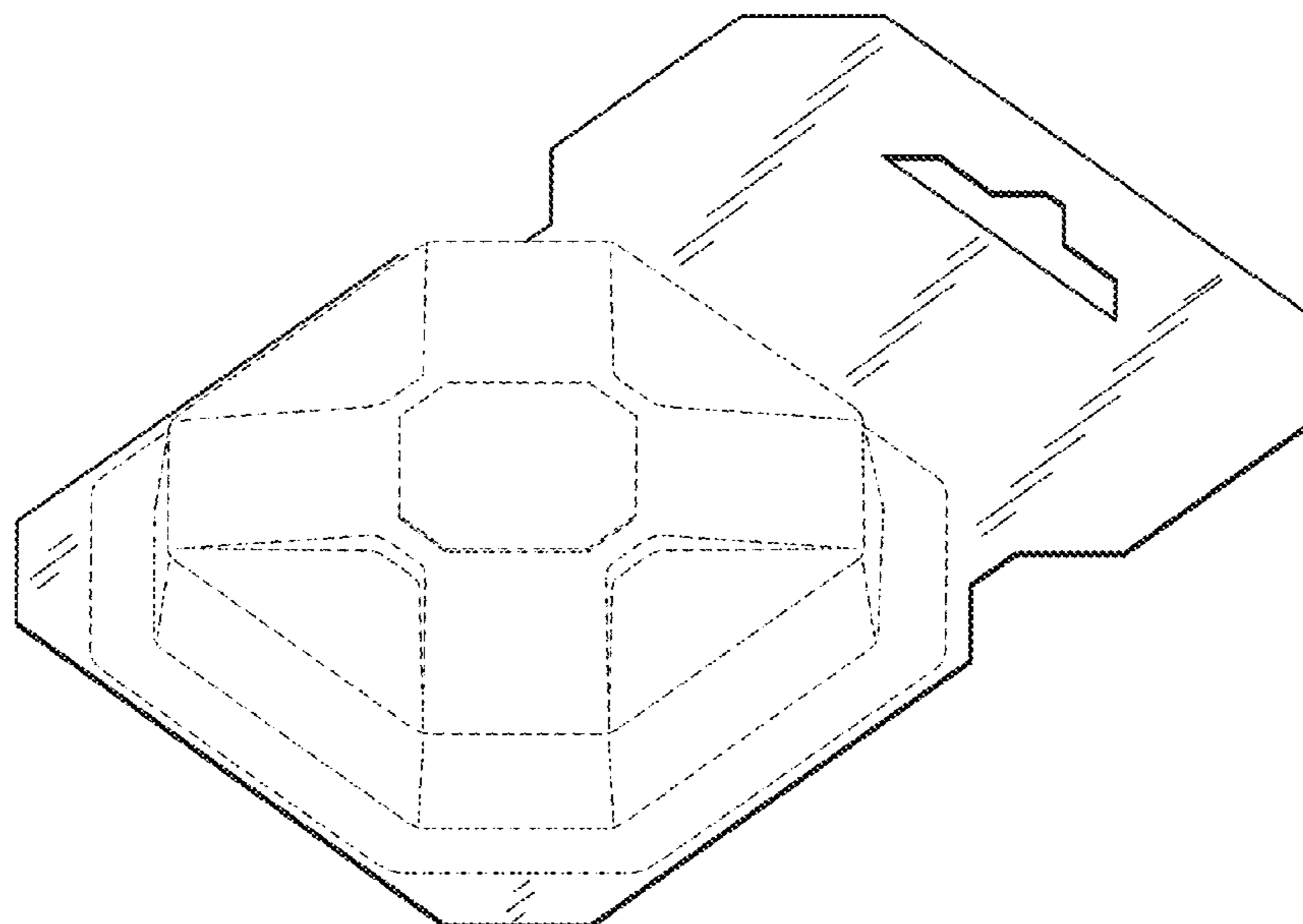

(56)

**References Cited**

U.S. PATENT DOCUMENTS

D479,687	S	*	9/2003	Kumakura	.....	D9/415
D479,688	S	*	9/2003	Kumakura	.....	D9/415
D481,941	S	*	11/2003	Kyne	.....	D9/418
D482,970	S	*	12/2003	Kumakura	.....	D9/415
D484,972	S	*	1/2004	Steele, IV	.....	D9/707
D494,465	S	*	8/2004	Kyne	.....	D9/418
D535,554	S	*	1/2007	Kent	.....	D9/415
D544,788	S	*	6/2007	Brittain	.....	D9/415
D584,138	S	*	1/2009	Lafortezza	.....	D9/415
D608,221	S	*	1/2010	Marchetti	.....	D9/732
D615,402	S	*	5/2010	Doster	.....	D9/415
D628,090	S	*	11/2010	Stuiber	.....	D9/732
D637,073	S	*	5/2011	Morcos	.....	D9/415
D682,084	S	*	5/2013	Pierre	.....	D9/415
D692,295	S	*	10/2013	Whalen, Jr.	.....	D9/415
D695,624	S	*	12/2013	Brillanti Ventura	.....	D9/651
D710,684	S	*	8/2014	Mizuno	.....	D9/415
D711,219	S	*	8/2014	Palsson	.....	D9/415
D716,647	S	*	11/2014	Mizuno	.....	D9/415
D833,861	S	*	11/2018	Stadelmaier	.....	D9/415
D908,478	S	*	1/2021	Nelson	.....	D9/415
D952,162	S	*	5/2022	Hitschmann	.....	D24/189

\* cited by examiner

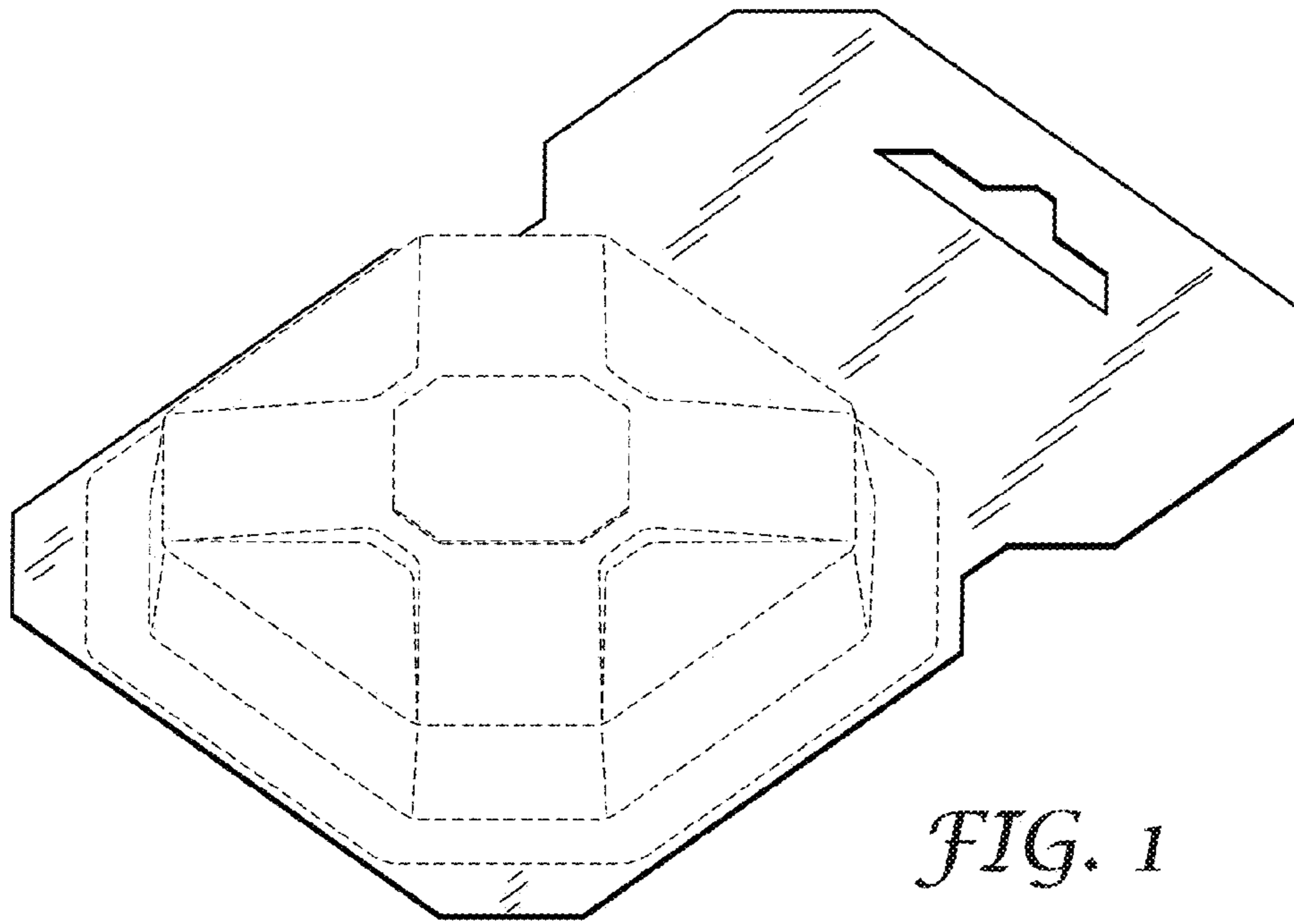

*FIG. 1*

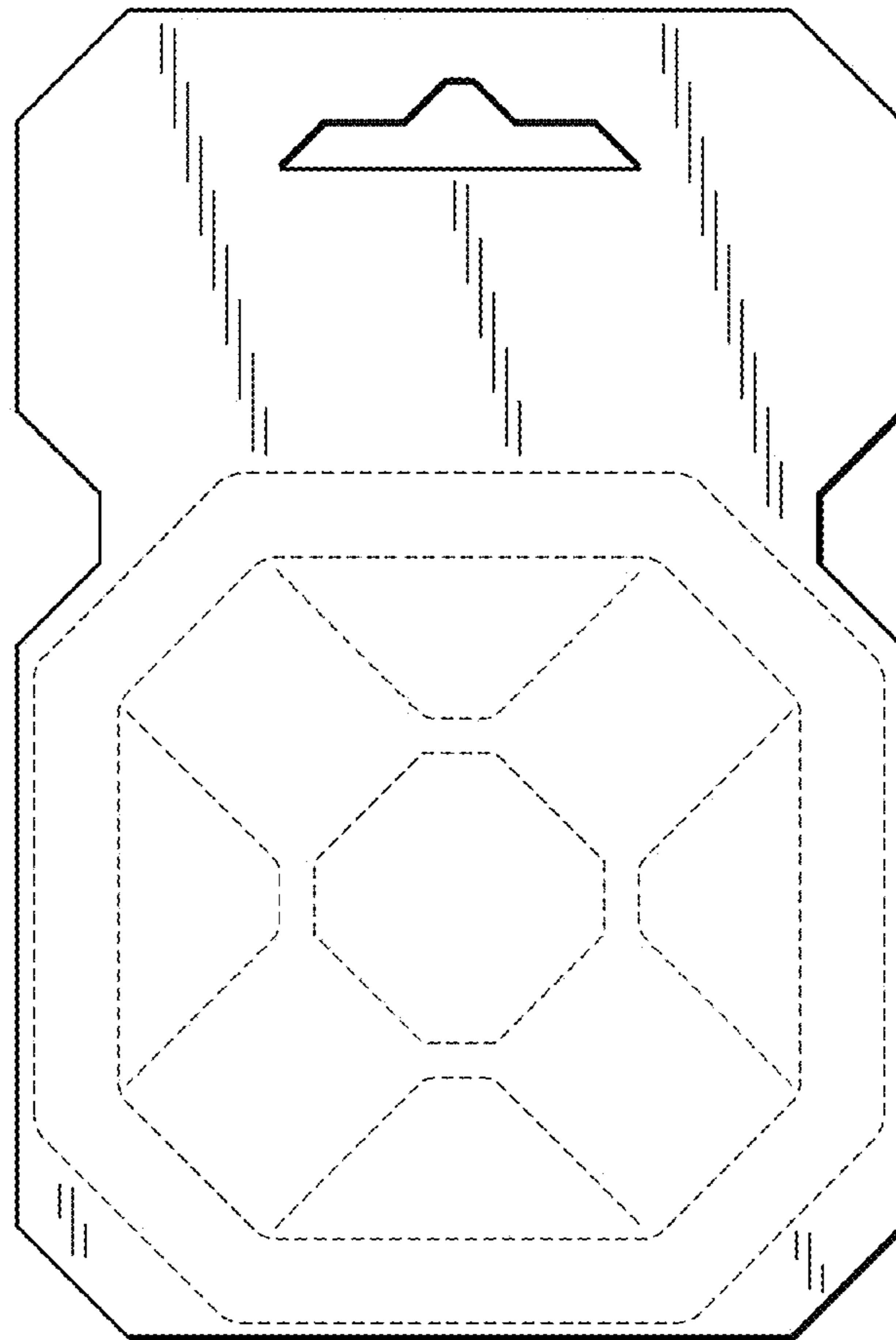

*FIG. 2*

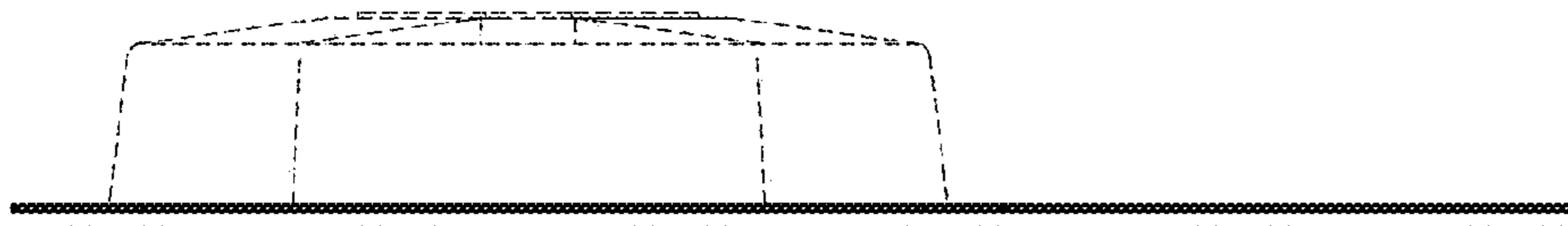

*FIG. 3*

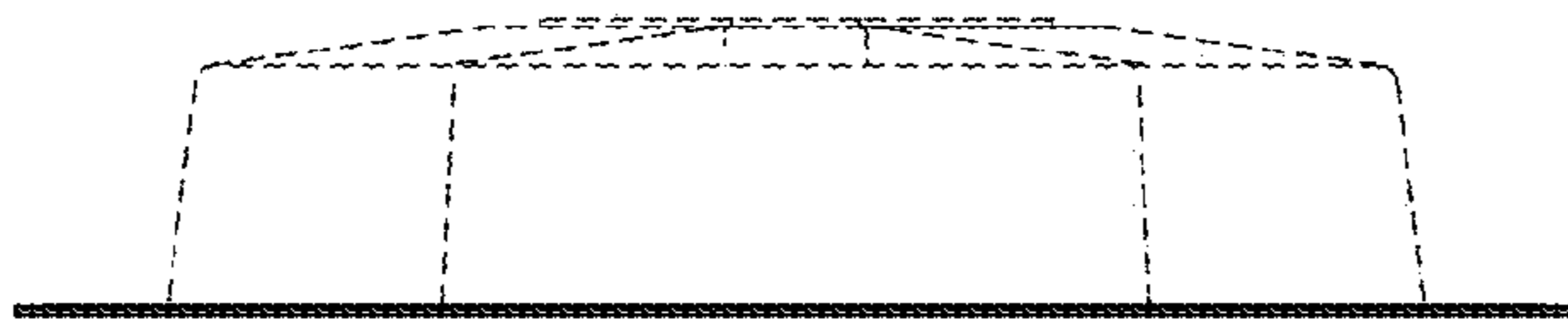

*FIG. 4*

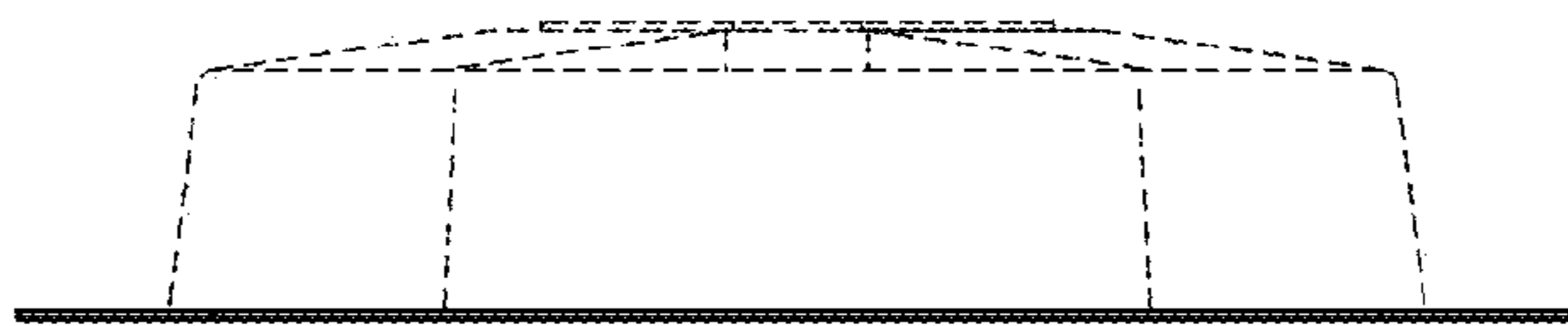

*FIG. 5*

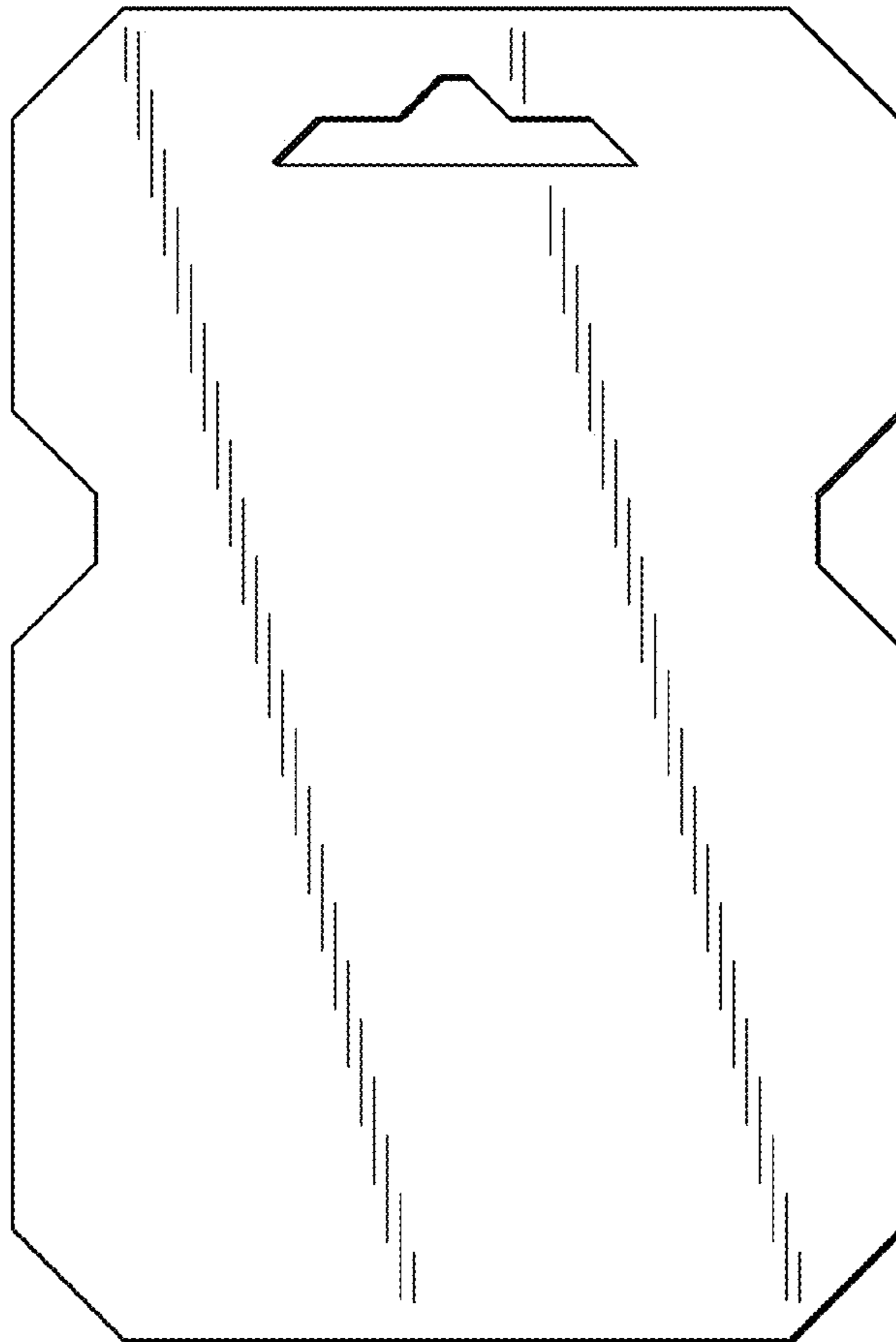

*FIG. 6*