

US00D966053S

(12) **United States Design Patent** (10) **Patent No.:** **US D966,053 S**
Krasnopolskiy et al. (45) **Date of Patent:** **** Oct. 11, 2022**

(54) **GRINDER APPARATUS**

(71) Applicants: **Vadim Krasnopolskiy**, East Brunswick, NJ (US); **German Shestakov**, East Brunswick, NJ (US)

(72) Inventors: **Vadim Krasnopolskiy**, East Brunswick, NJ (US); **German Shestakov**, East Brunswick, NJ (US)

(**) Term: **15 Years**

(21) Appl. No.: **29/752,917**

(22) Filed: **Sep. 29, 2020**

(51) **LOC (13) Cl.** **07-04**

(52) **U.S. Cl.**
USPC **D7/679**

(58) **Field of Classification Search**
USPC D7/372, 373, 374, 401.1, 590, 591, 592, D7/593, 594, 595, 596, 597, 679; D9/442, 445, 449, 450, 454, 455, 499, D9/500, 503, 504, 529, 549, 559, 574, D9/714, 727, 905; D27/161, 186, 187, D27/191, 194, 195; D28/76, 77, 78, 82, D28/85, 86, 87, 88, 91.1

CPC A23F 5/00; A23F 5/08; A24B 7/04; A45D 33/28; A45D 34/00; A45D 34/045; A45D 34/06; A45D 40/00; A45D 40/0025; A45D 40/02; A45D 40/04; A45D 40/06; A45D 2200/05; A47J 42/00; A47J 42/02; A47J 42/04; A47J 42/06; A47J 42/08; A47J 42/10; A47J 42/12; A47J 42/14; A47J 42/16; A47J 42/18; A47J 42/24; A47J 42/34; A47J 42/38; A47J 42/50; A47J 42/52; A61M 11/006; A61M 11/08

See application file for complete search history.

(56) **References Cited**

U.S. PATENT DOCUMENTS

D273,365 S * 4/1984 Lukins D9/454
D281,054 S * 10/1985 Menrad D28/91.1

D285,732 S * 9/1986 Holloway D28/89
D287,339 S * 12/1986 Dominski D9/560
D295,482 S * 5/1988 Bunge D7/608
D302,873 S * 8/1989 Sayn Wittgenstein D9/529
5,000,601 A * 3/1991 Wruck A45D 40/06
401/86
6,405,951 B1 * 6/2002 Wu A47J 42/08
241/169.1
D545,147 S * 6/2007 Marshall D7/679
D553,450 S * 10/2007 Sorensen D7/679
D662,827 S * 7/2012 Watabe D9/453
D695,627 S * 12/2013 Chen D9/687

(Continued)

FOREIGN PATENT DOCUMENTS

CN 305043016 * 2/2019

Primary Examiner — Andrew Kerr

Assistant Examiner — Chariton Alexakis

(74) *Attorney, Agent, or Firm* — Walter J. Tencza, Jr.

(57) **CLAIM**

We claim the ornamental design for the grinder apparatus, as shown and described.

DESCRIPTION

FIG. 1 is a front, top perspective view of a grinder apparatus, showing my design;
FIG. 2 is a front elevational view thereof;
FIG. 3 is a rear elevational view thereof;
FIG. 4 is a left side elevational view thereof;
FIG. 5 is a right side elevational view thereof;
FIG. 6 is a top plan view thereof;
FIG. 7 is a bottom plan view thereof;
FIG. 8 is a front and top perspective view thereof in a disassembled state; and,
FIG. 9 is a top plan view thereof.
The broken lines showing in the drawings depict portions of the grinder apparatus that form no part of the claimed design.

1 Claim, 8 Drawing Sheets

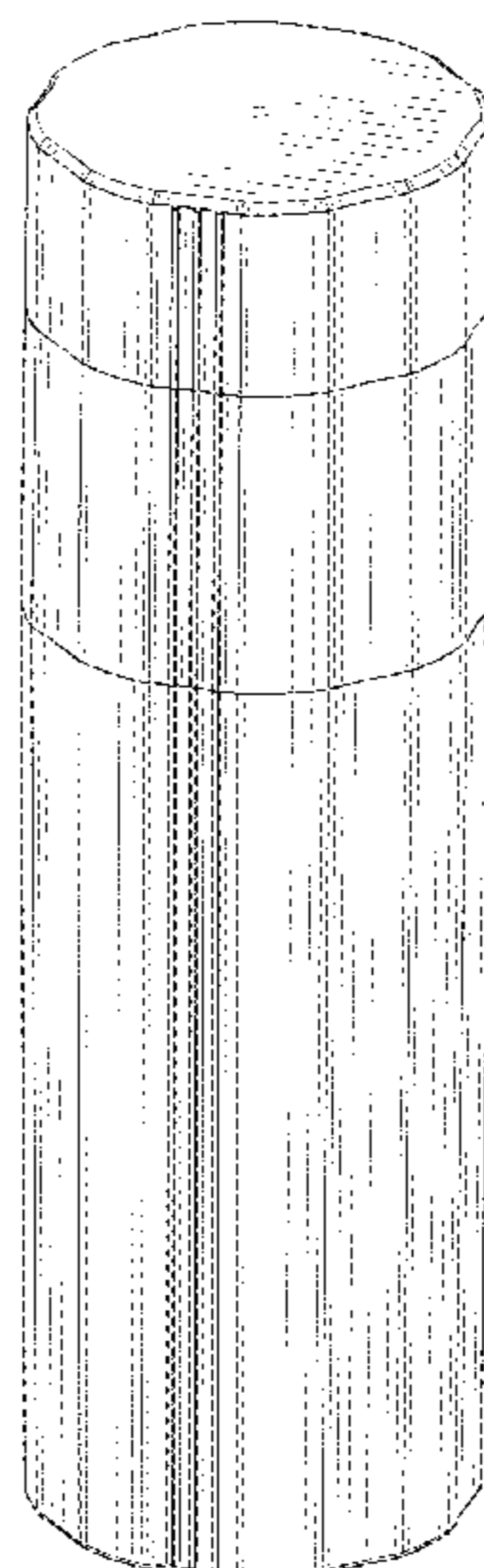

(56)

References Cited

U.S. PATENT DOCUMENTS

D717,653 S * 11/2014 Chur D9/435
D760,087 S * 6/2016 Dittmer D9/569
9,427,020 B2 8/2016 Ruzycky
9,873,125 B1 * 1/2018 LaGuardia, Jr. A47J 42/24
D846,197 S * 4/2019 Apodaca D9/559
D846,995 S * 4/2019 El Beaini D9/504
D849,530 S * 5/2019 Fremgen D9/737
D898,296 S * 10/2020 Min A47J 42/08
D28/85
D920,578 S * 5/2021 Min A47J 42/24
D9/559
D930,906 S * 9/2021 Jung B65D 21/0228
D9/504
2020/0156823 A1 * 5/2020 Hon B65D 21/0228
2021/0106116 A1 * 4/2021 Gim B65D 51/32
2021/0127901 A1 * 5/2021 Krasnopolskiy A47J 42/24

* cited by examiner

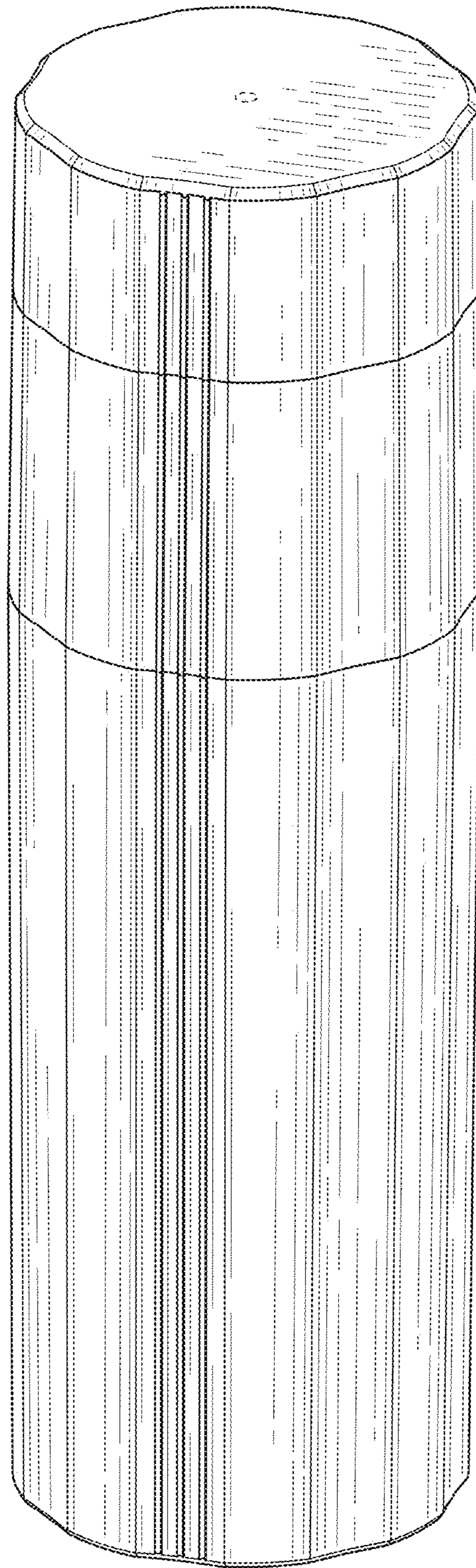

FIG. 1

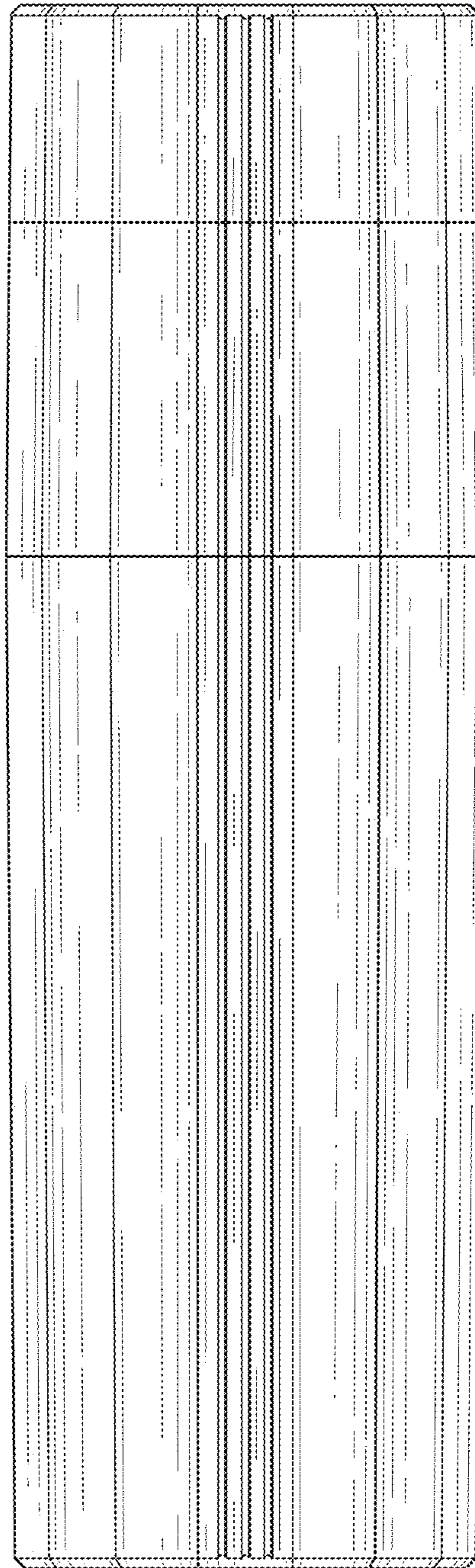

FIG. 2

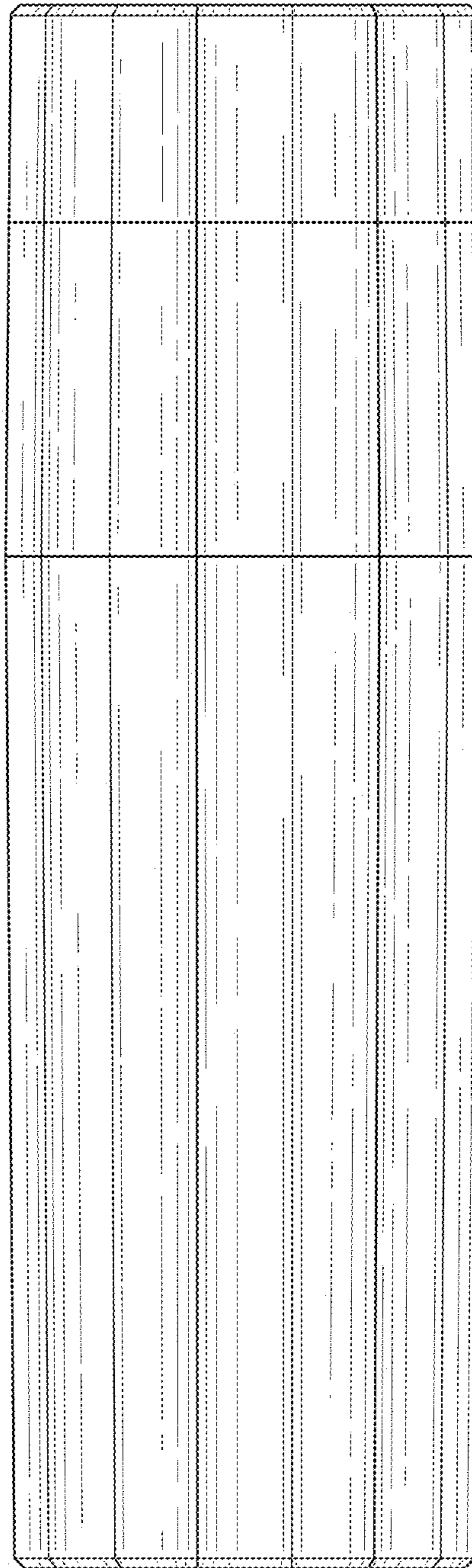

FIG. 3

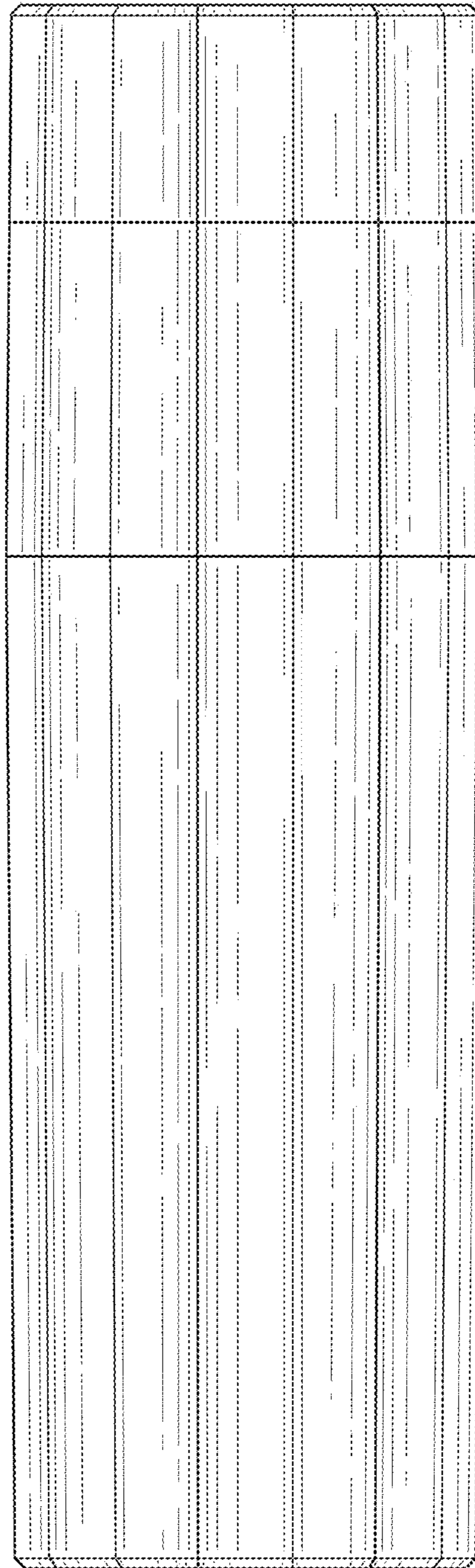

FIG. 4

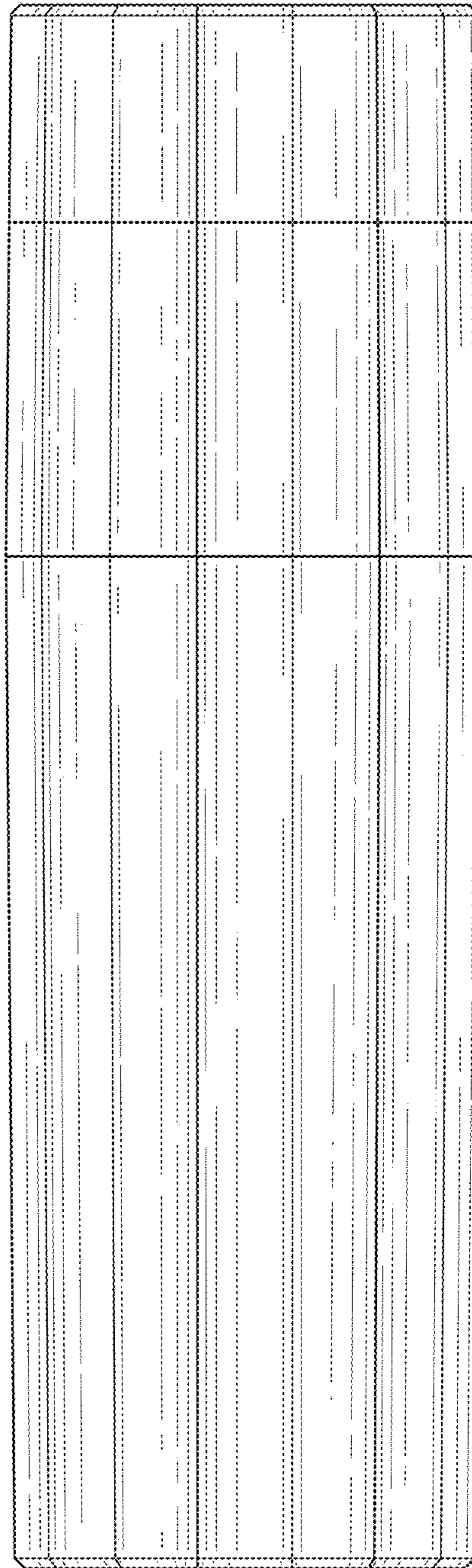

FIG. 5

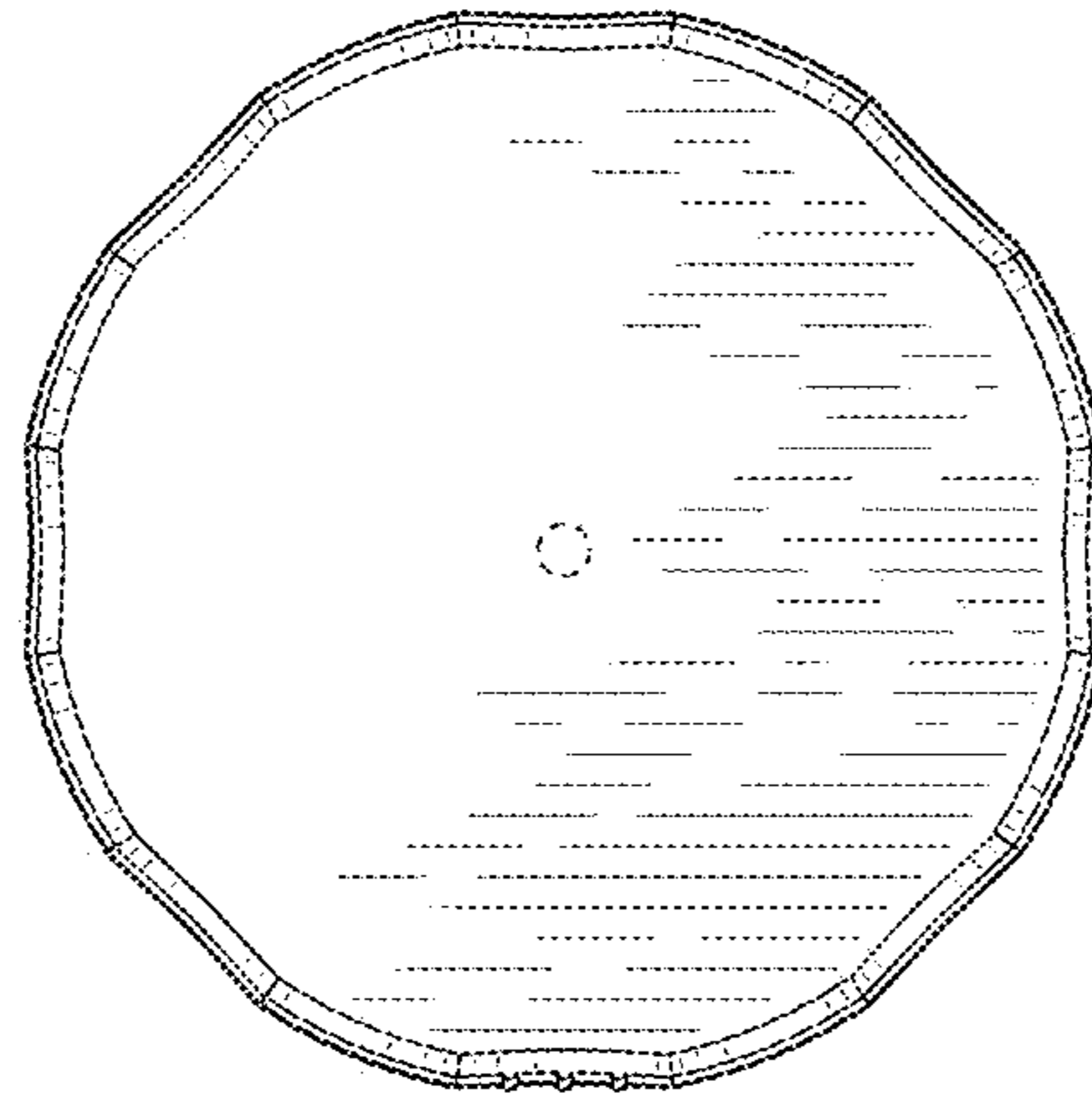

FIG. 6

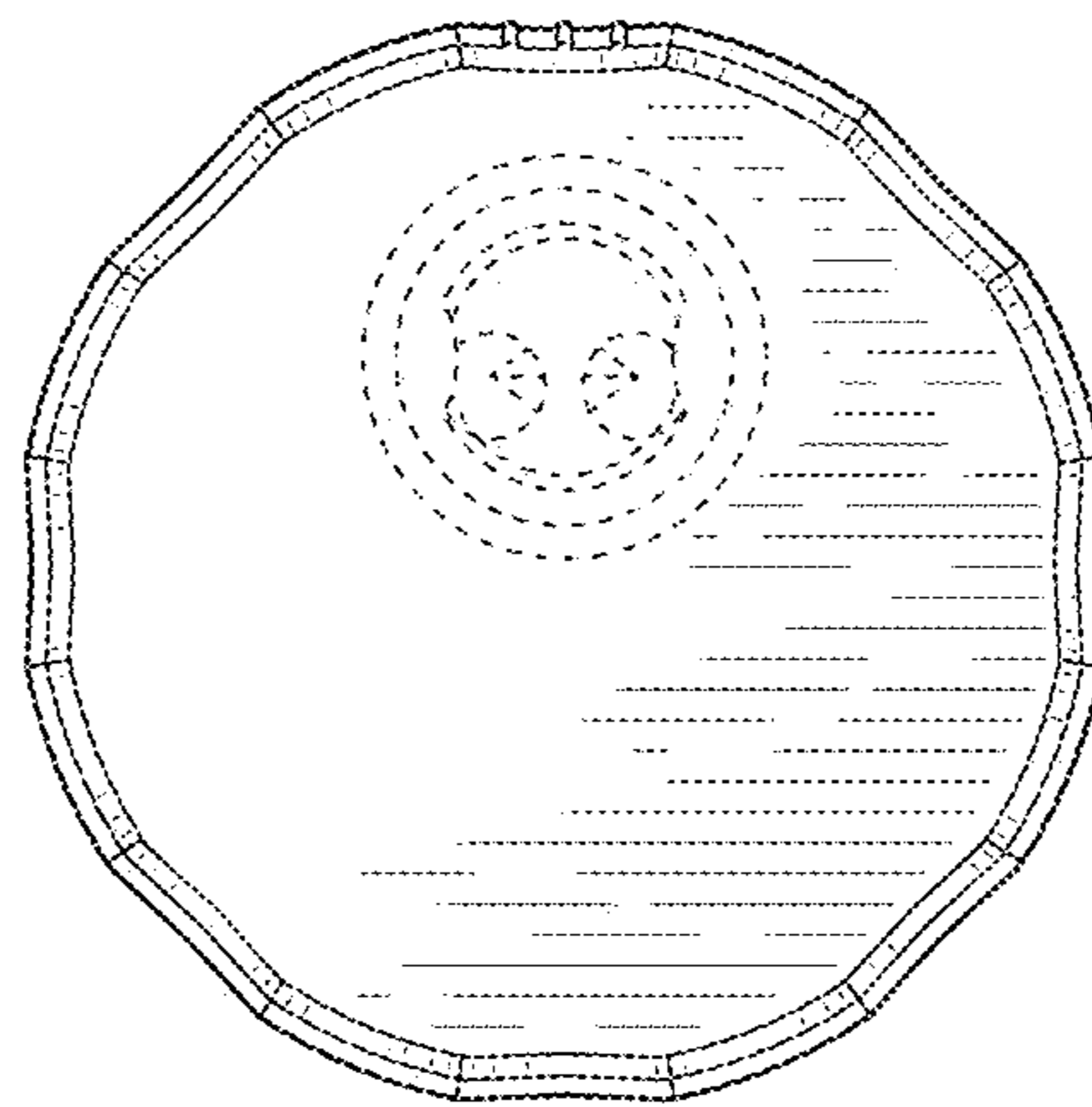

FIG. 7

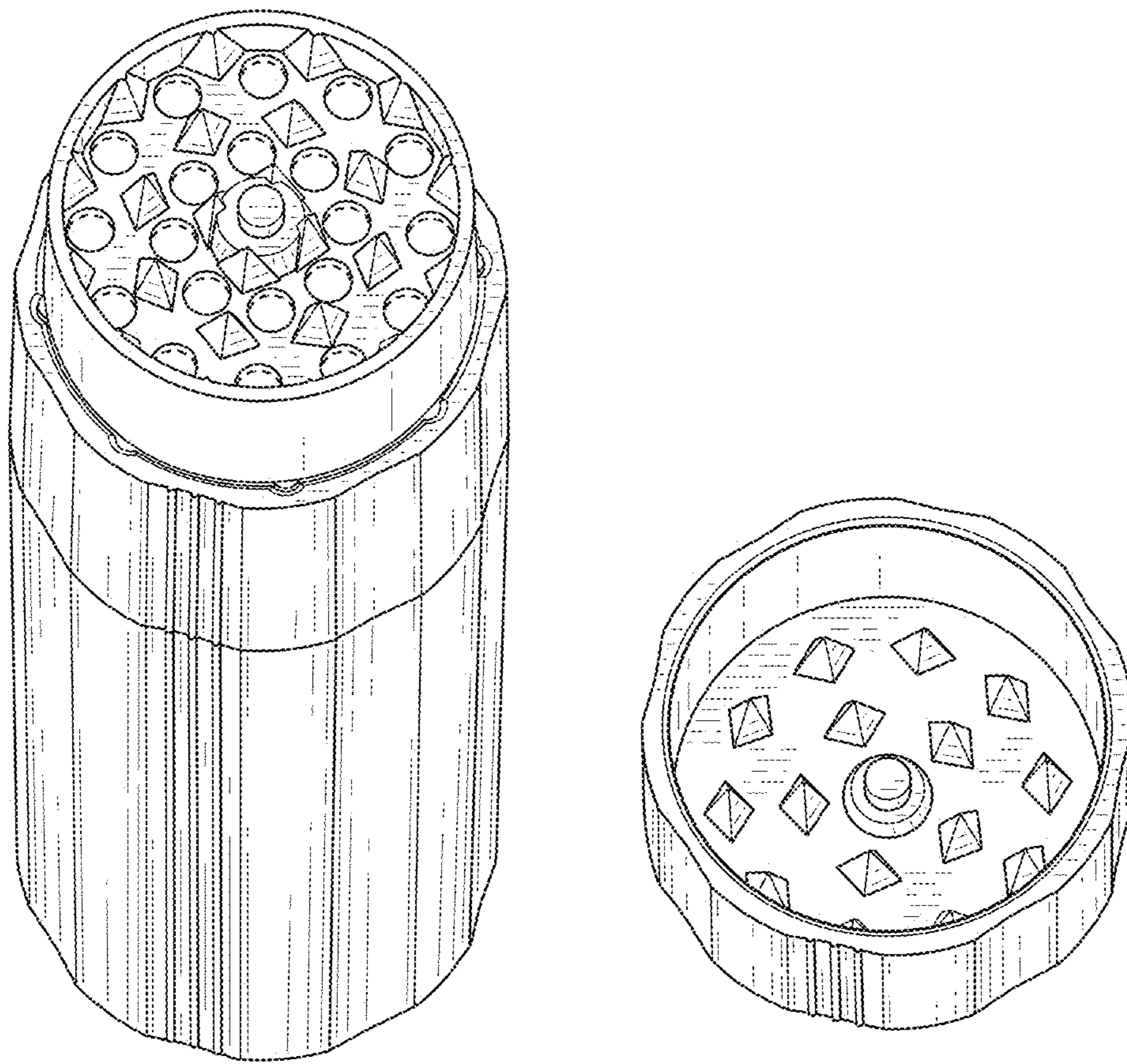

FIG. 8

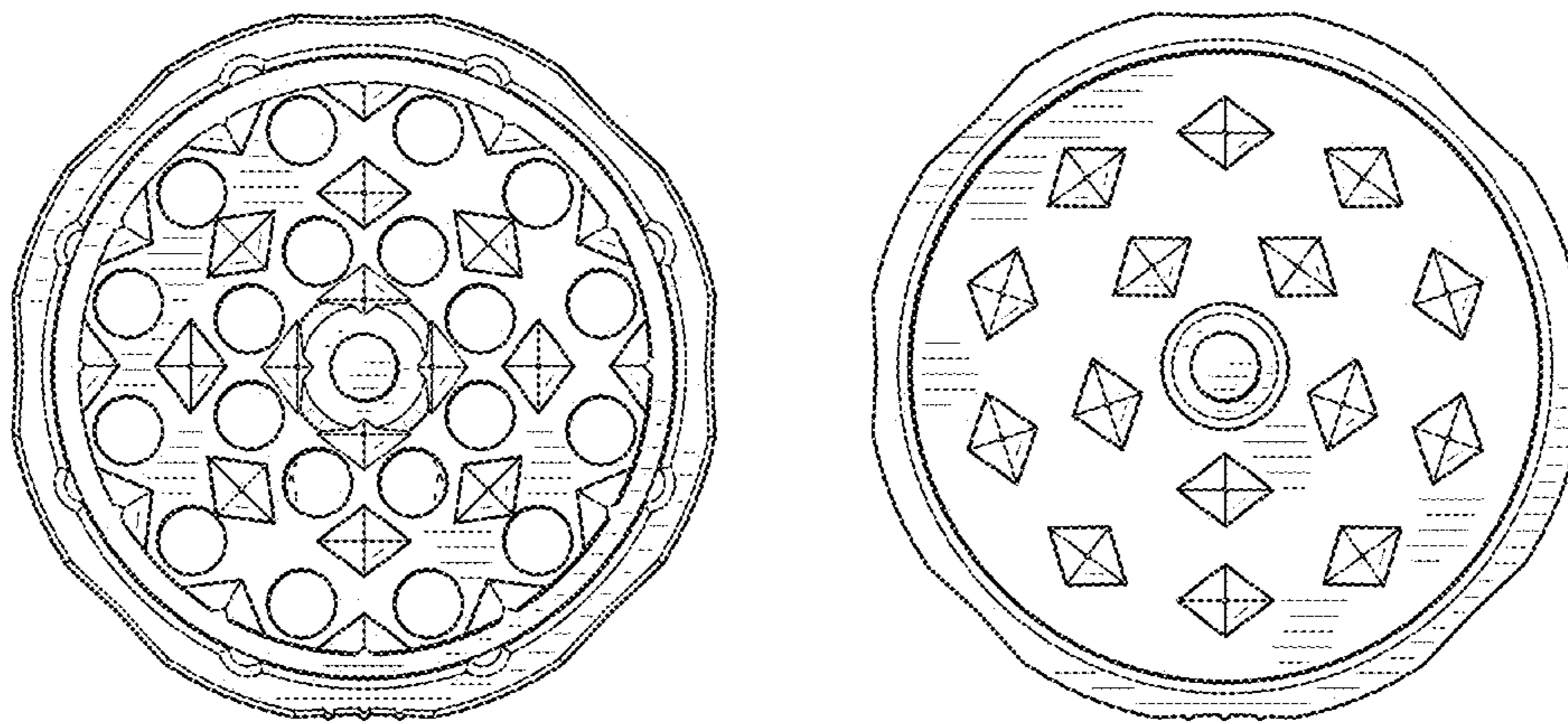

FIG. 9