

US00D966003S

(12) **United States Design Patent** (10) **Patent No.:** **US D966,003 S**  
**Yuglich** (45) **Date of Patent:** **\*\* \*Oct. 11, 2022**

(54) **CHAIR**  
(71) Applicant: **Maximillian Yuglich**, Houston, TX (US)  
(72) Inventor: **Maximillian Yuglich**, Houston, TX (US)  
(\* ) Notice: This patent is subject to a terminal disclaimer.

D547,957 S \* 8/2007 Muller ..... D6/360  
D609,035 S \* 2/2010 Muller ..... D6/716  
D659,424 S \* 5/2012 Gramza ..... D6/380  
D660,028 S \* 5/2012 Rode ..... D6/360  
D660,041 S \* 5/2012 Rode ..... D6/374  
D661,918 S \* 6/2012 Ciani ..... D6/375  
D730,100 S \* 5/2015 Kubryk ..... D6/716  
D736,534 S \* 8/2015 Stania ..... D6/374  
D800,465 S \* 10/2017 Ono ..... D6/360  
D800,466 S \* 10/2017 Ono ..... D6/360

(Continued)

(\*\*) Term: **15 Years**

OTHER PUBLICATIONS

(21) Appl. No.: **29/763,682**  
(22) Filed: **Dec. 23, 2020**  
(51) **LOC (13) Cl.** ..... **06-01**  
(52) **U.S. Cl.**  
USPC ..... **D6/374**  
(58) **Field of Classification Search**  
USPC ..... D6/369, 370, 379, 375, 372, 716.4, 371,  
D6/374, 334, 381, 717, 360, 380, 716  
CPC ..... A47C 1/124; A47C 3/025; A47C 3/18;  
A47C 3/12; A47C 3/34; A47C 4/028;  
A47C 4/02; A47C 5/12; A47C 5/125;  
A47C 5/02; A47C 5/06; A47C 5/08;  
A47C 7/445; A47C 7/443; A47C 7/60;  
A47C 7/506; A47C 9/007; A47C 13/005;  
A47C 13/023; A47C 31/003; A47C  
31/008; A47C 31/113; A47C 31/02; A47B  
85/04; B60R 2/0284; B60R 2/062; B60R  
22/001; B60R 22/24; B60R 22/28; B60R  
22/58; B60R 22/64; B60R 22/68; B60R  
22/80; B60R 22/99; B60R 22/245; B60R  
22/643; B60R 22/646; B60R 22/665;  
B60R 22/686; B60R 22/688; B60R  
22/803; B60R 22/986; B60R 22/914;  
B60R 22/995

“Hassen Side Chair” Feb. 27, 2018, wayfair.com, site visited Feb. 10, 2022 <[https://www.wayfair.com/Wade-Logan%C2%AE--Hassen-Side-Chair-X114576239-L168-K-W003465128.html?refid=GX528897189976-W003465128\\_1123152737&device=c&ptid=946485446812&network=g&targetid=aud-352581794606:pla-946485446812&channel=GooglePLA&ireid=87973725&fdid=1817&PiID%5B%5D=1123152737&gclid=EAIAIqobChMI2-qak6j29QIVQ-DICH0B7wUXEAsYASABEgl2u\\_D\\_BwE](https://www.wayfair.com/Wade-Logan%C2%AE--Hassen-Side-Chair-X114576239-L168-K-W003465128.html?refid=GX528897189976-W003465128_1123152737&device=c&ptid=946485446812&network=g&targetid=aud-352581794606:pla-946485446812&channel=GooglePLA&ireid=87973725&fdid=1817&PiID%5B%5D=1123152737&gclid=EAIAIqobChMI2-qak6j29QIVQ-DICH0B7wUXEAsYASABEgl2u_D_BwE)> (Year: 2018).\*

Primary Examiner — Paul D Bohannon  
(74) Attorney, Agent, or Firm — Bushman Werner, P.C.

(57) **CLAIM**

The ornamental design for a chair, as shown and described.

**DESCRIPTION**

FIG. 1 is a perspective view of the chair showing the claimed design.  
FIG. 2 is a side, elevational view of the chair of FIG. 1. The opposite side is a mirror image and thus is not provided in a separate figure.  
FIG. 3 is a front, elevational view of the chair of FIG. 1.  
FIG. 4 is a rear, elevational view of the chair shown in FIG. 1.  
FIG. 5 is a top plan view of the chair shown in FIG. 1; and, FIG. 6 is a bottom view of the chair shown in FIG. 1.

(Continued)

(56) **References Cited**

U.S. PATENT DOCUMENTS

D158,508 S \* 5/1950 Saarinen ..... D6/374  
D190,955 S \* 7/1961 Galloway ..... D6/374

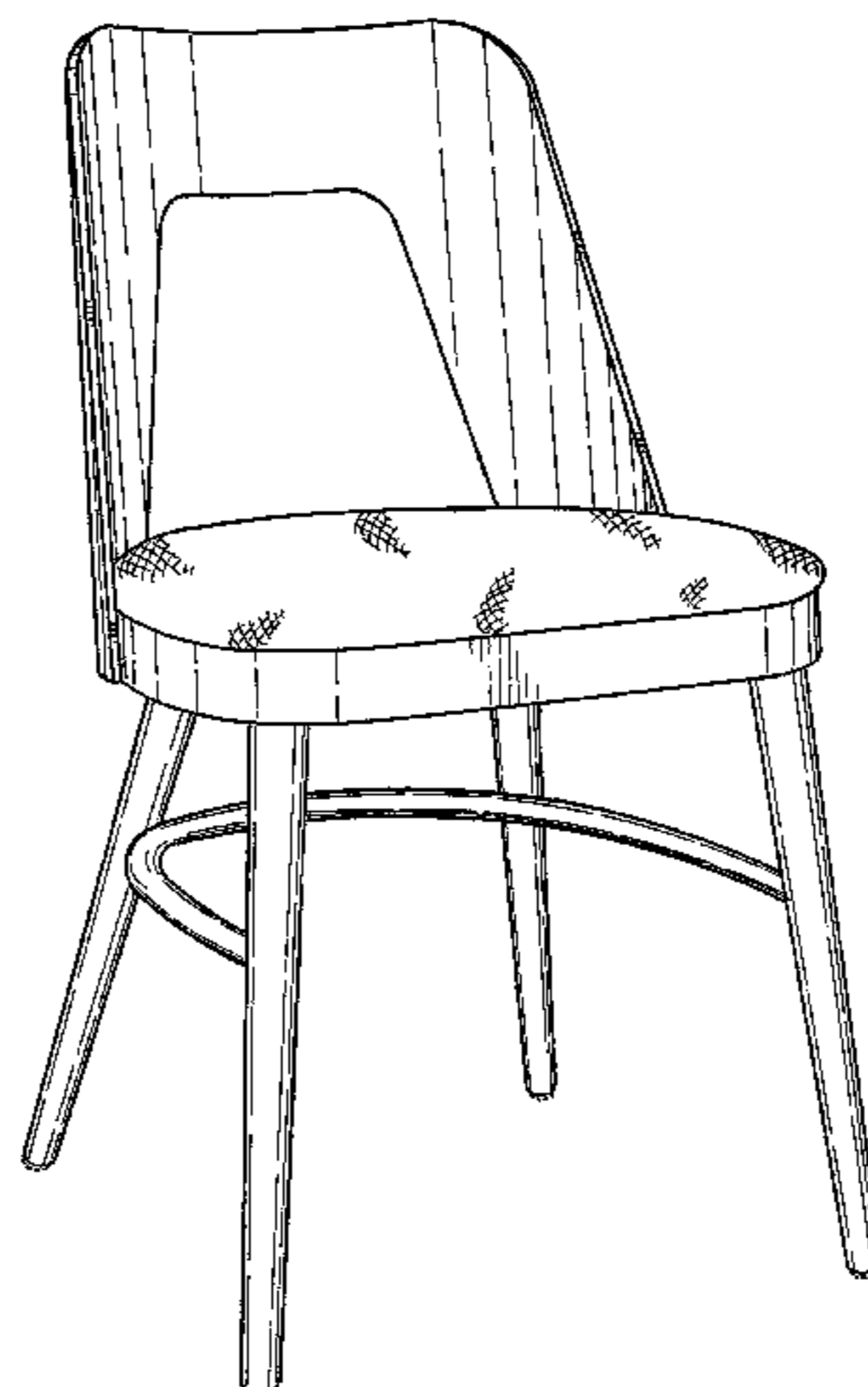

The broken lines shown in the drawings are included for the purpose of illustrating portions of the article that form no part of the claimed design.

**1 Claim, 6 Drawing Sheets**

(56) **References Cited**

U.S. PATENT DOCUMENTS

D805,797	S	*	12/2017	Toffoloni	.....	D6/380
D834,345	S	*	11/2018	Yuglich	.....	D6/374
D834,847	S	*	12/2018	Yuglich	.....	D6/374
D845,021	S	*	4/2019	Bray	.....	D6/375
D850,138	S	*	6/2019	Taraba	.....	D6/380
D879,496	S	*	3/2020	Velez	.....	D6/380
D899,119	S	*	10/2020	Velez	.....	D6/360
D907,389	S	*	1/2021	Morrison	.....	D6/374
D907,390	S	*	1/2021	Morrison	.....	D6/374
2021/0186218	A1	*	6/2021	Guichard	.....	A47C 7/44

\* cited by examiner

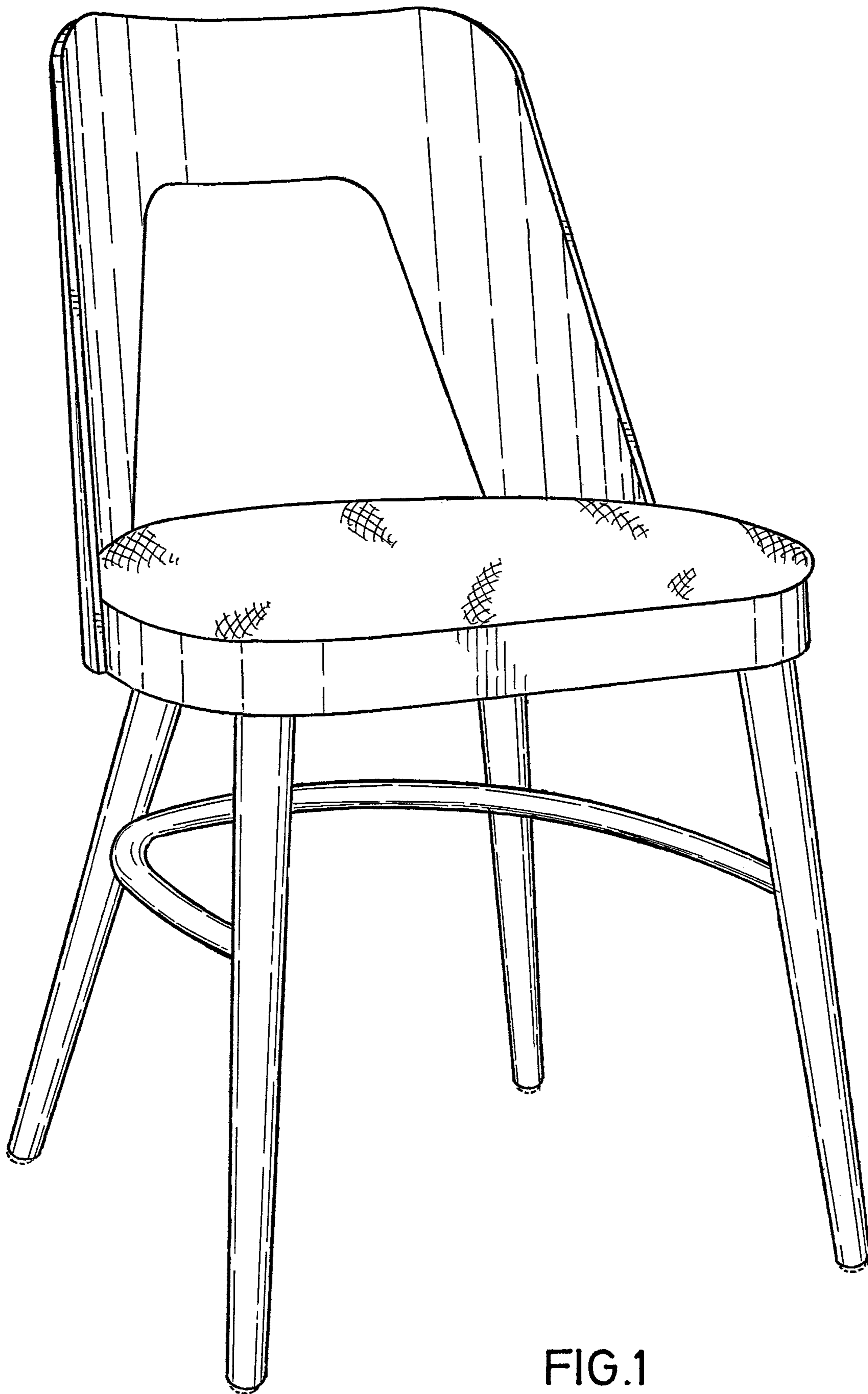
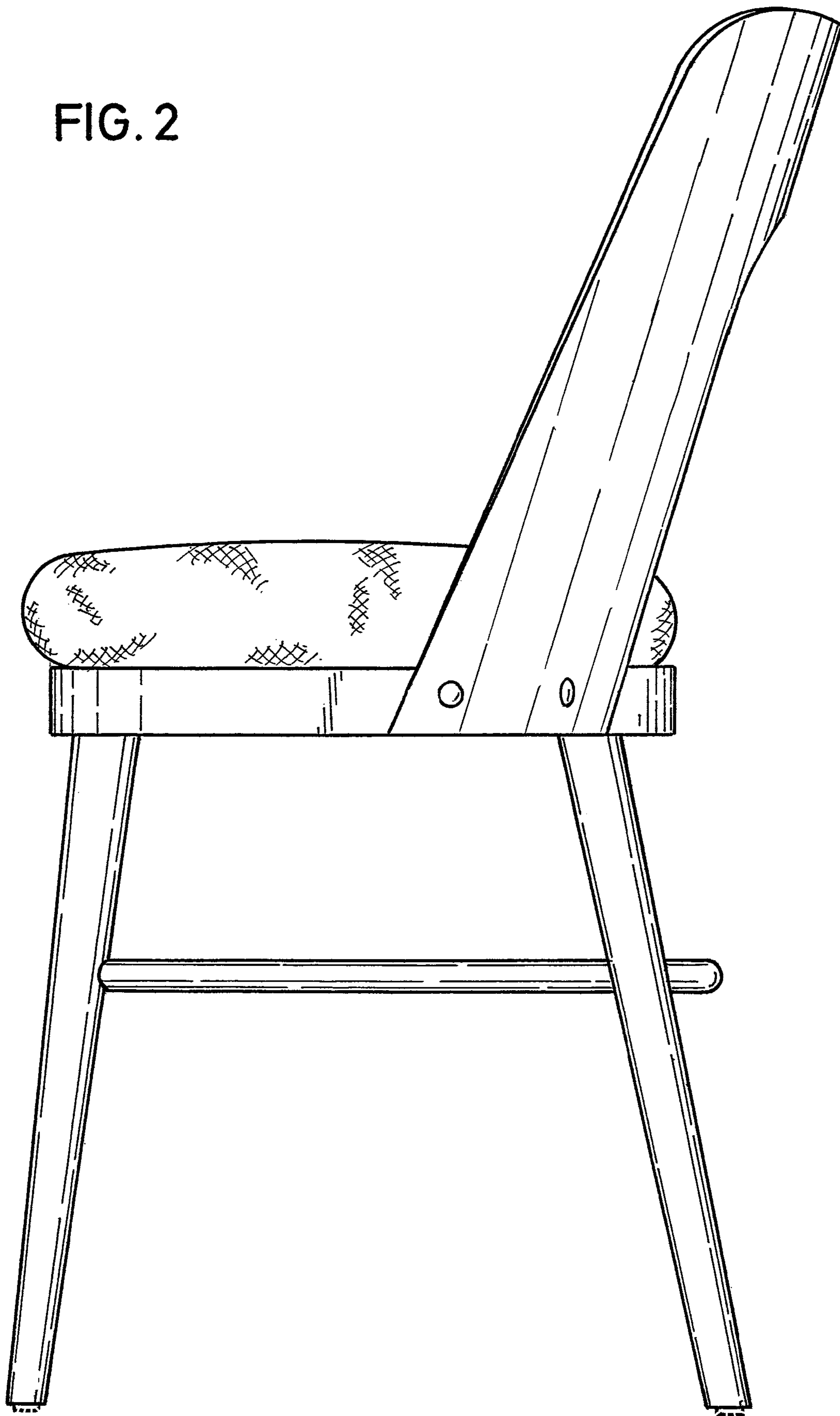

FIG. 1

FIG. 2



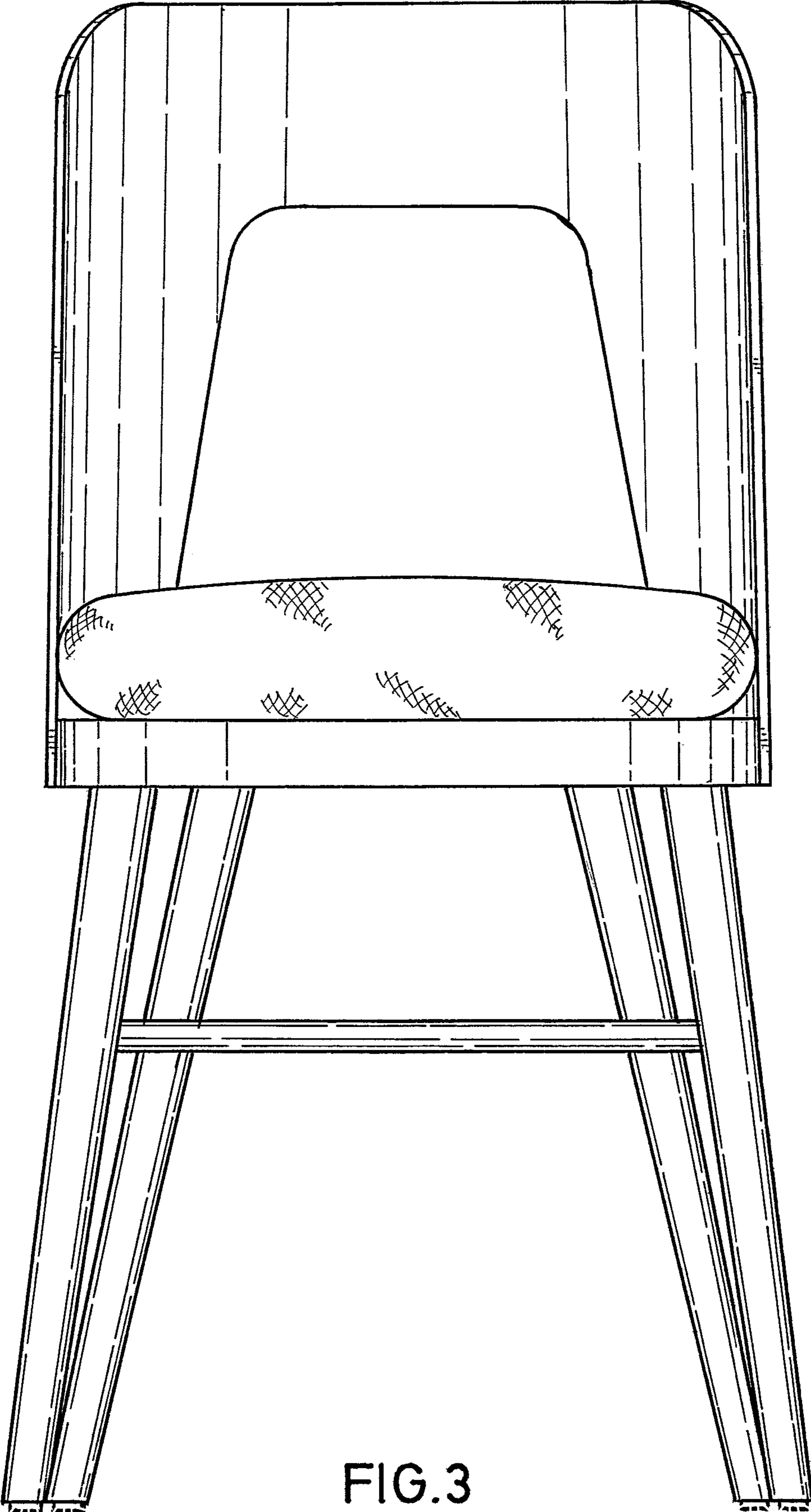

FIG. 3

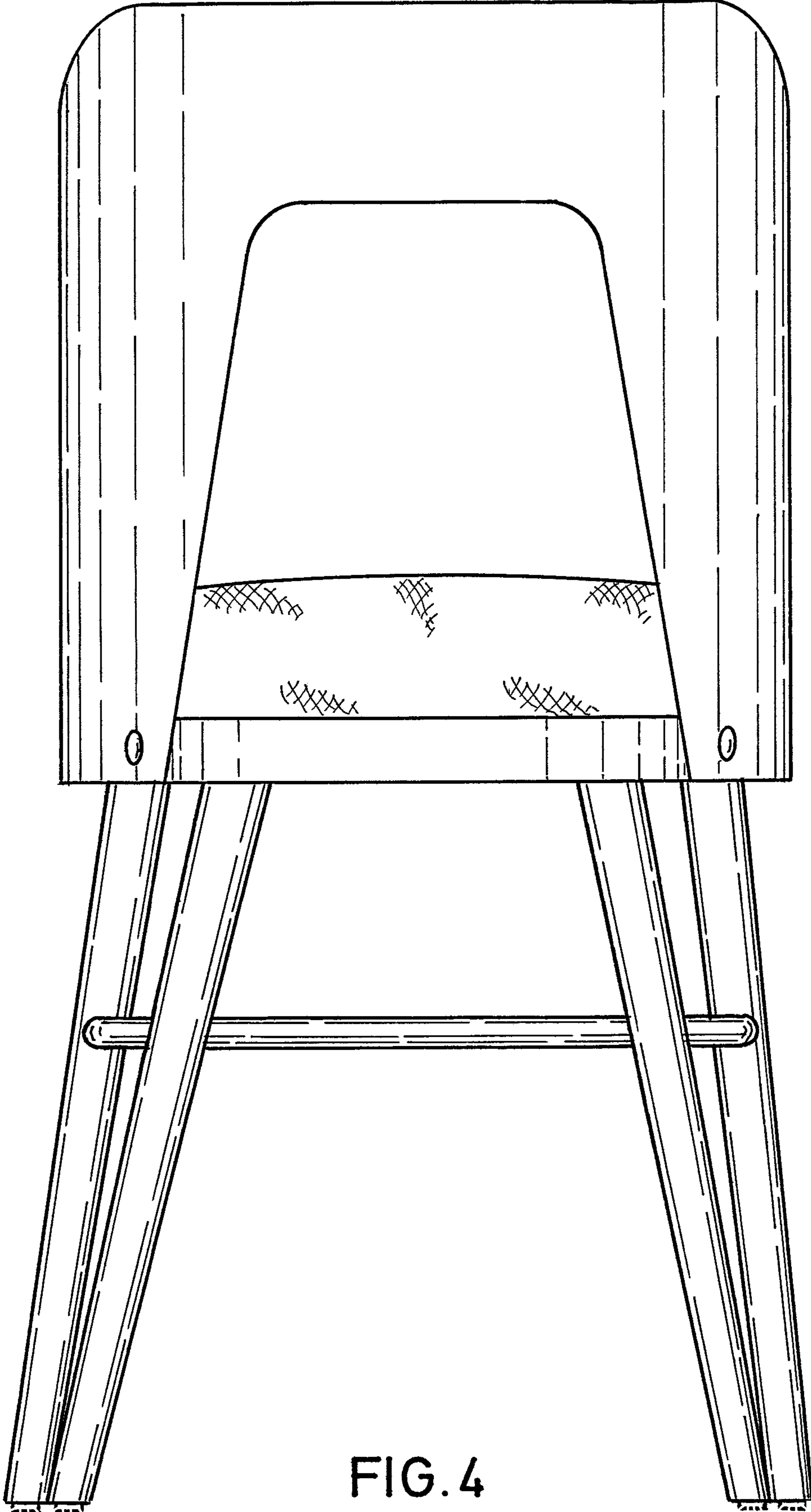

FIG. 4

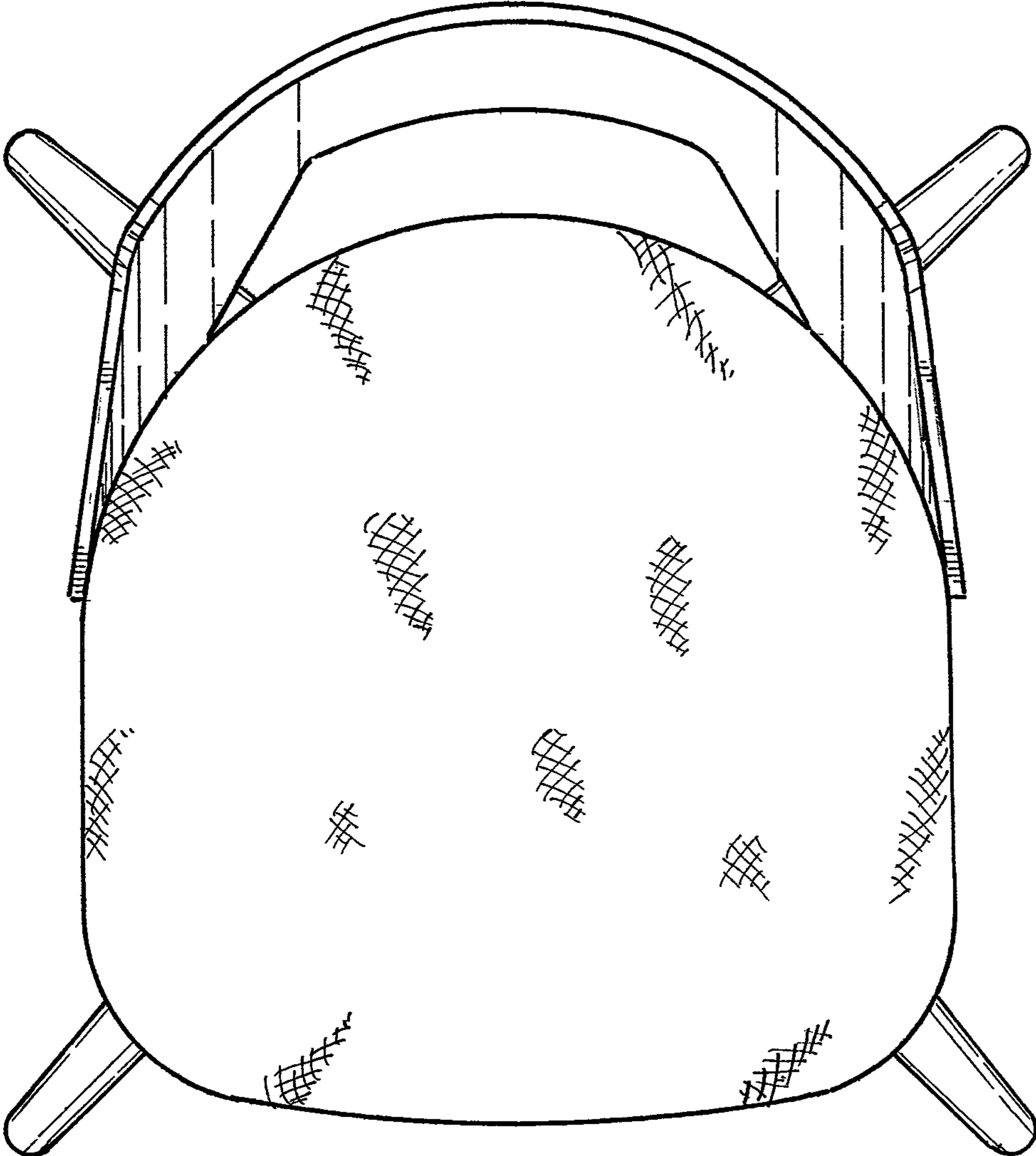

FIG. 5

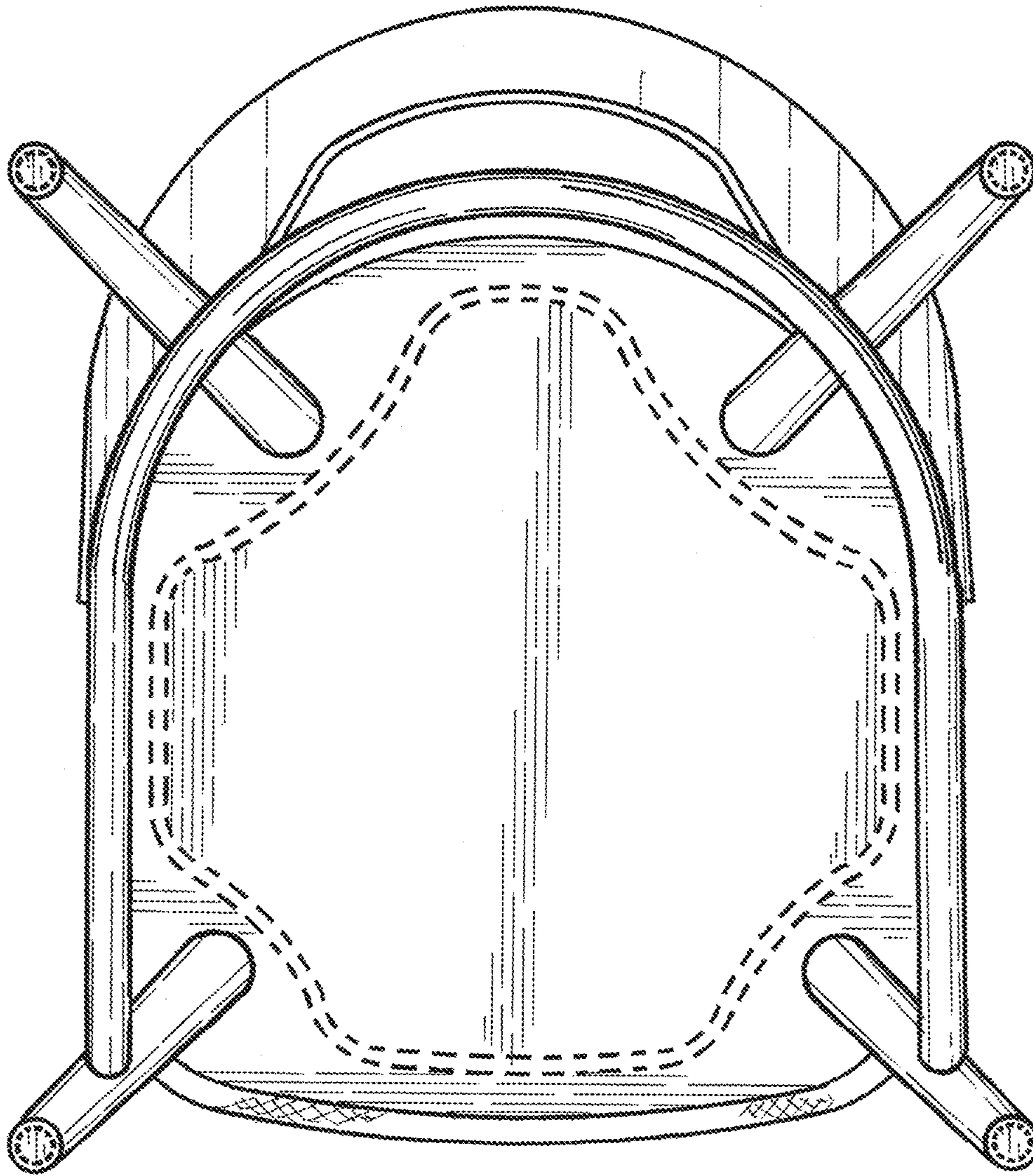

FIG. 6