



US00D965990S

(12) **United States Design Patent**
Gold et al.

(10) **Patent No.:** **US D965,990 S**
(45) **Date of Patent:** **** Oct. 11, 2022**

(54) **PATTERNED REFLECTIVE MATERIAL**

(71) Applicant: **3M Innovative Properties Company**,
Saint Paul, MN (US)

(72) Inventors: **Anne C. Gold**, South St. Paul, MN
(US); **Silvia G. B. Guttmann**, Saint
Paul, MN (US); **Thomas J. Gilbert**,
Saint Paul, MN (US); **Corey D.**
Voelker, Ellsworth, WI (US); **Bernerd**
A. Koch, Saint Paul, MN (US)

(73) Assignee: **3M Innovative Properties Company**,
St. Paul, MN (US)

(**) Term: **15 Years**

(21) Appl. No.: **29/616,100**

(22) Filed: **Sep. 1, 2017**

(51) **LOC (13) Cl.** **05-05**

(52) **U.S. Cl.**
USPC **D5/53; D5/58**

(58) **Field of Classification Search**
USPC D5/1-4, 6, 7, 11, 16, 19, 20, 23, 32, 43,
D5/44, 46-64, 66, 99; D6/578, 582-584;
D19/1, 5; D25/110-112, 138, 140, 149,
D25/151; D32/40; D24/189
CPC ... B31F 1/00; B31F 1/07; B32B 3/266; B32B
5/024; B44F 1/00; B44F 1/02; B44F
1/08; B44F 1/10; B44F 5/00; B44F 7/00;
B44F 9/00; B44F 9/04; B44F 11/00;
B44F 11/02; B44F 11/04; D03D 1/00;
D04H 1/00; D04H 1/02; D10B 2503/04;
D21H 27/02

See application file for complete search history.

(56) **References Cited**

U.S. PATENT DOCUMENTS

D20,107 S * 8/1890 Carr D6/583
D29,459 S * 10/1898 Parker D6/582
D40,194 S * 7/1909 Bright D5/47

980,638 A * 1/1911 Hill B21D 31/043
D5/1
1,372,741 A * 3/1921 Dickinson E04F 13/04
D5/1
1,488,804 A * 4/1924 Brown A47G 27/0412
428/78
1,637,410 A * 8/1927 Coryell E04F 13/04
D5/1
2,025,708 A * 12/1935 Baker B21D 31/04
D5/1
2,325,903 A * 8/1943 Blair B29C 44/28
D5/53
2,408,082 A * 9/1946 Mack E04B 5/10
D5/1
2,446,771 A * 8/1948 Knowland B29C 59/04
D5/53
D185,027 S * 4/1959 McCord D5/53
2,885,749 A * 5/1959 Jureit F16B 15/0046
D5/1
2,958,608 A * 11/1960 Barnard D06C 23/00
428/141
3,040,968 A * 6/1962 Long B65D 29/04
229/87.08
3,065,785 A * 11/1962 Taber A47H 23/04
160/81
3,109,579 A * 11/1963 Crane B65D 29/04
D9/427
D218,597 S * 9/1970 Stone D5/1
3,642,967 A * 2/1972 Doll B31D 5/0065
264/51
3,756,907 A * 9/1973 Heling D04H 1/00
162/114
4,560,372 A * 12/1985 Pieniak A61F 13/532
604/369
4,567,011 A * 1/1986 Nalle, Jr. B29D 28/00
264/147
4,615,671 A * 10/1986 Bernal B26F 1/18
264/146
4,676,784 A * 6/1987 Erdman A61F 13/5323
604/368
4,712,868 A 12/1987 Tung
D314,673 S * 2/1991 Legare D5/59
5,232,533 A * 8/1993 Tani D04H 3/14
156/177
D370,566 S * 6/1996 Koster D5/1
5,667,871 A * 9/1997 Goodrich B31C 5/00
206/521
5,713,881 A * 2/1998 Rezai A61F 13/15203
604/365
5,791,030 A * 8/1998 Aihara B29C 55/08
26/100

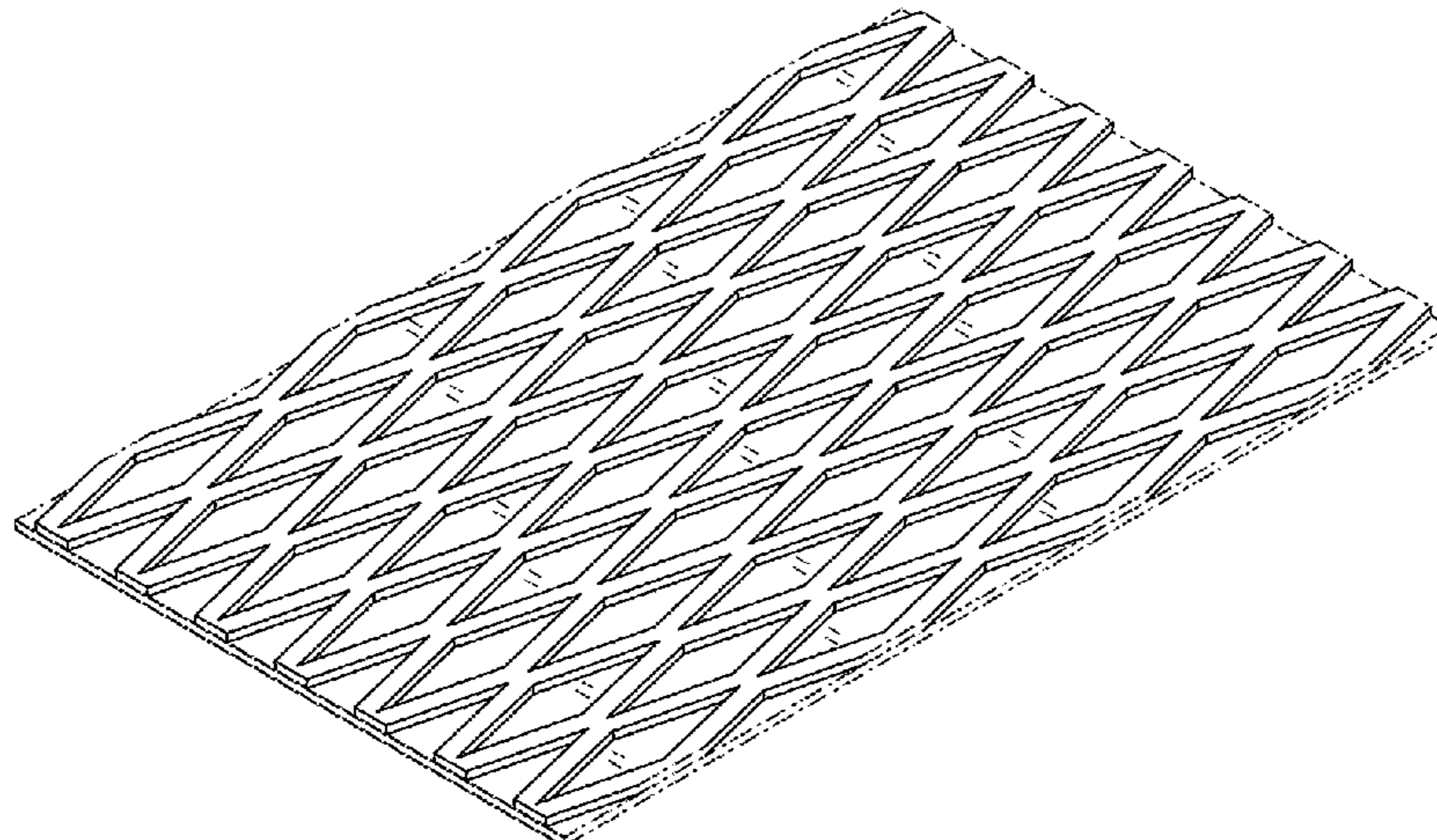

5,868,724	A *	2/1999	Dierckes, Jr.	A61F 13/15658 604/368
6,155,698	A	12/2000	Yoon	
D630,860	S *	1/2011	Sichel	D5/58
D644,441	S	9/2011	Hutchison	
D660,008	S *	5/2012	Carminati Molina	D5/56
D663,126	S	7/2012	Lapinid, Jr.	
D672,154	S	12/2012	Huss	
D681,963	S	5/2013	Lee	
D682,558	S	5/2013	Lee	
8,851,688	B2	10/2014	Huang	
9,234,990	B2	1/2016	Huang	
D792,714	S	7/2017	Delaney	
D793,098	S	8/2017	Collis	
D794,181	S *	8/2017	Gilbert	D24/126
D796,033	S *	8/2017	Gilbert	D24/126
9,820,888	B2 *	11/2017	Greener	A61F 13/00038
10,369,061	B2 *	8/2019	Jonegren	B32B 5/04
10,646,383	B2 *	5/2020	Ronnberg	A61F 13/514
10,722,093	B2 *	7/2020	Tuman	A47L 13/20
2003/0019009	A1	1/2003	Feduzi	
2005/0123720	A1 *	6/2005	Suzuki	B32B 27/06 428/131
2007/0207286	A1 *	9/2007	Craig	A47L 23/266 428/89
2008/0081529	A1 *	4/2008	Gehring, Jr.	D04B 21/12 442/308
2010/0259050	A1	10/2010	Meller	
2010/0269467	A1 *	10/2010	Crabtree	B01D 46/10 55/499
2012/0204383	A1 *	8/2012	Wood	B29C 71/02 24/306
2012/0330266	A1 *	12/2012	Zonneveld	B23P 13/00 604/391
2013/0012898	A1 *	1/2013	Bergendahl	A61F 13/15699 604/365
2014/0295134	A1 *	10/2014	Wood	C08G 18/797 428/135
2014/0332999	A1 *	11/2014	Rothwell	D01D 5/426 264/172.11
2017/0027778	A1 *	2/2017	Stridfeldt	A61F 13/8405
2018/0338869	A1 *	11/2018	Jonegren	A61F 13/537
2019/0187345	A1 *	6/2019	Gold	B32B 5/022
2020/0209442	A1 *	7/2020	Gold	B32B 25/04

FOREIGN PATENT DOCUMENTS

CN	304242521	8/2017
CN	304242555	8/2017
CN	304242663	8/2017
CN	304242875	8/2017
CN	304243350	8/2017
CN	304243399	8/2017
CN	304244048	8/2017
CN	304244620	8/2017
CN	304558807	3/2018
CN	304565469	4/2018
CN	304677475	6/2018
EM	004207009-0001	11/2017
EM	004207009-0002	11/2017
EM	004207009-0003	11/2017
EM	004207009-0004	11/2017
EM	004207009-0005	11/2017
EM	004207009-0006	11/2017
EM	004207009-0007	11/2017
EM	004207009-0008	11/2017
EM	004207009-0009	11/2017
EM	004207009-0010	11/2017
EM	004207009-0011	11/2017
EM	004207009-0012	11/2017
EM	004207009-0013	11/2017
EM	004207009-0014	11/2017
EM	004207504	12/2017
JP	1539013	11/2015
WO	WO 1993-01534	1/1993
WO	WO 2006-055082	5/2006

WO	WO 2007-045011	4/2007
WO	WO 2012-112768	8/2012
WO	WO 2015-089125	6/2015

OTHER PUBLICATIONS

Chinese Application 2017107910586 filed Sep. 1, 2017, to Gold et al.
 Chinese Application 2017211282123 filed Sep. 1, 2017, to Gold et al.
 Taiwan Application 106129954 filed Sep. 1, 2017, to Gold et al.

* cited by examiner

Primary Examiner — Wendy L Arminio
 (74) *Attorney, Agent, or Firm* — Johannes P. M. Kusters

(57) CLAIM

The ornamental design for a patterned reflective material, as shown and described.

DESCRIPTION

FIG. 1 is a front right perspective view of a patterned reflective material in accordance with an embodiment of the claimed design;
 FIG. 2 is a front elevation view of the design of FIG. 1;
 FIG. 3 is a rear elevation view of the design of FIG. 1;
 FIG. 4 is a bottom plan view of the design of FIG. 1;
 FIG. 5 is a right side elevation view of the design of FIG. 1;
 FIG. 6 is a front right perspective view of a patterned reflective material in accordance with another embodiment of the claimed design;
 FIG. 7 is a front elevation view of the design of FIG. 6;
 FIG. 8 is a rear elevation view of the design of FIG. 6;
 FIG. 9 is a bottom plan view of the design of FIG. 6;
 FIG. 10 is a right side elevation view of the design of FIG. 6;
 FIG. 11 is a front right perspective view of a patterned reflective material in accordance with another embodiment of the claimed design;
 FIG. 12 is a front elevation view of the design of FIG. 11;
 FIG. 13 is a rear elevation view of the design of FIG. 11;
 FIG. 14 is a bottom plan view of the design of FIG. 11;
 FIG. 15 is a right side elevation view of the design of FIG. 11;
 FIG. 16 is a front right perspective view of a patterned reflective material in accordance with another embodiment of the claimed design;
 FIG. 17 is a front elevation view of the design of FIG. 16;
 FIG. 18 is a rear elevation view of the design of FIG. 16;
 FIG. 19 is a bottom plan view of the design of FIG. 16;
 FIG. 20 is a right side elevation view of the design of FIG. 16;
 FIG. 21 is a front right perspective view of a patterned reflective material in accordance with another embodiment of the claimed design;
 FIG. 22 is a front elevation view of the design of FIG. 21;
 FIG. 23 is a rear elevation view of the design of FIG. 21;
 FIG. 24 is a bottom plan view of the design of FIG. 21; and,
 FIG. 25 is a right side elevation view of the design of FIG. 21.
 The dot-dash broken lines in the figures immediately adjacent the solid lines illustrate a boundary between claimed and unclaimed subject matter and form no part of the claimed design.

The surfaces between the solid lines and between the solid lines and the dot-dash broken lines are part of the claimed design. These surfaces may not include surface shading, for the purpose of clarity, due to proximity of the lines.

The left side elevation views and the top plan views of each of the embodiments illustrated are not shown and form no part of the claimed design.

1 Claim, 5 Drawing Sheets

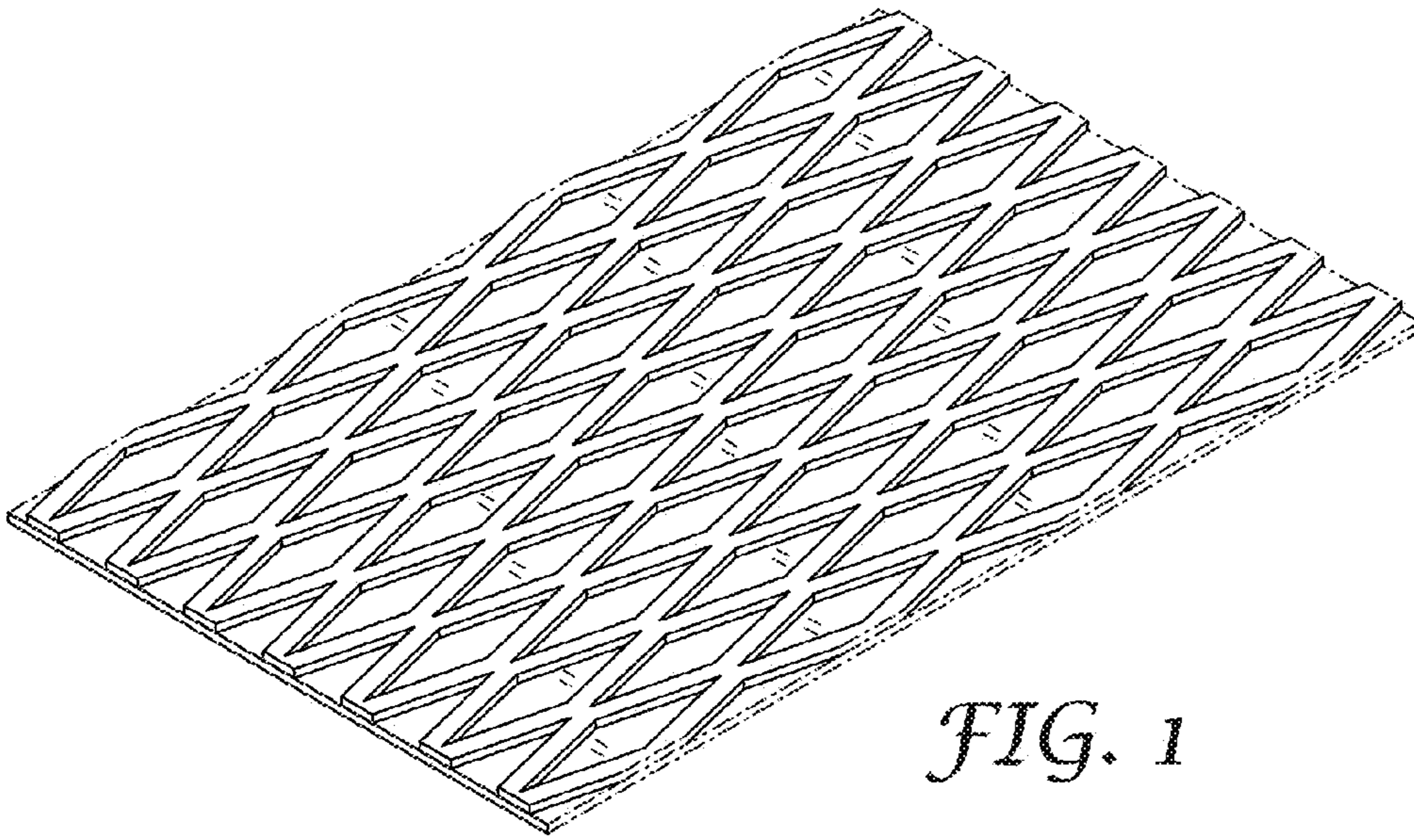

FIG. 1

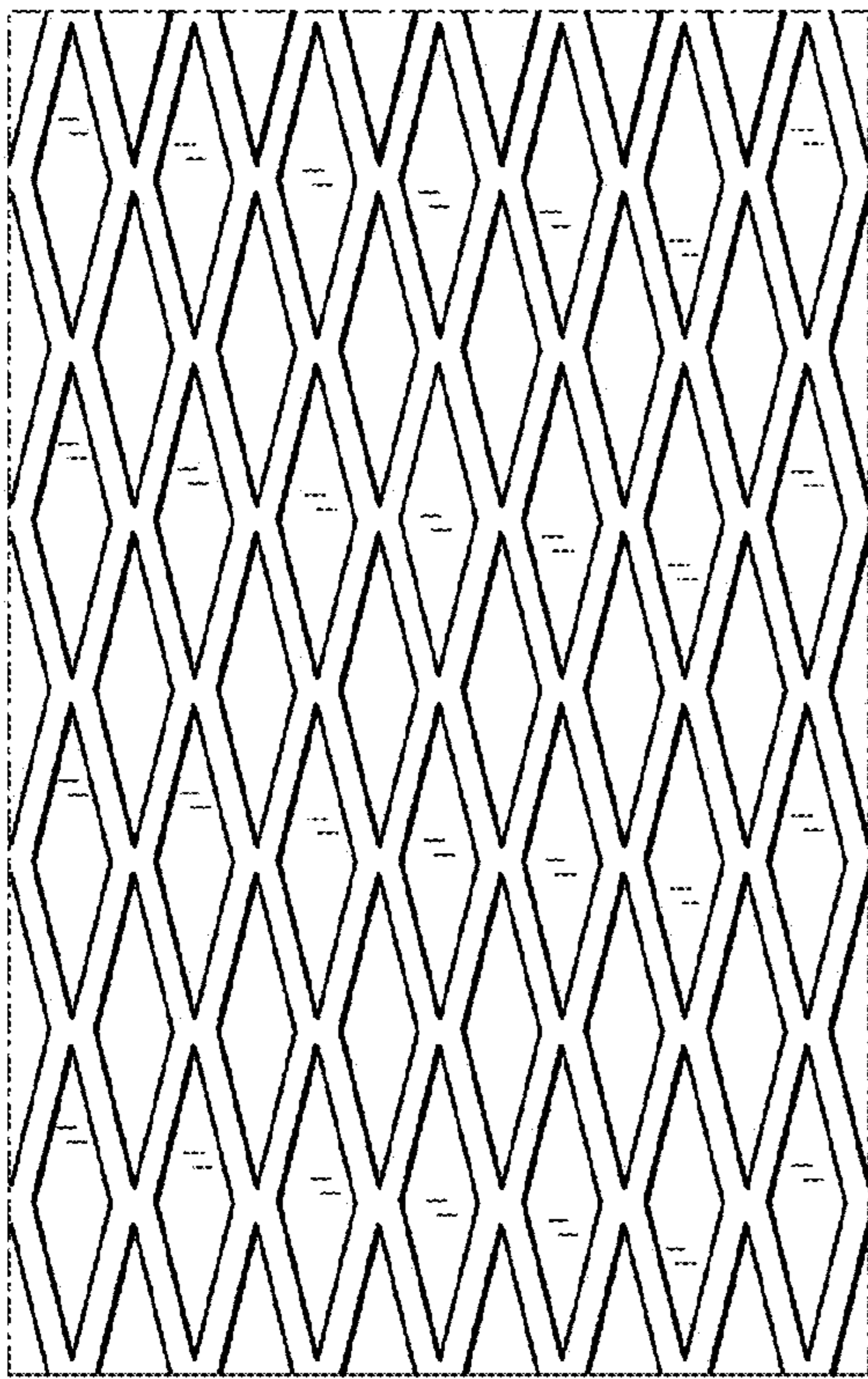

FIG. 2

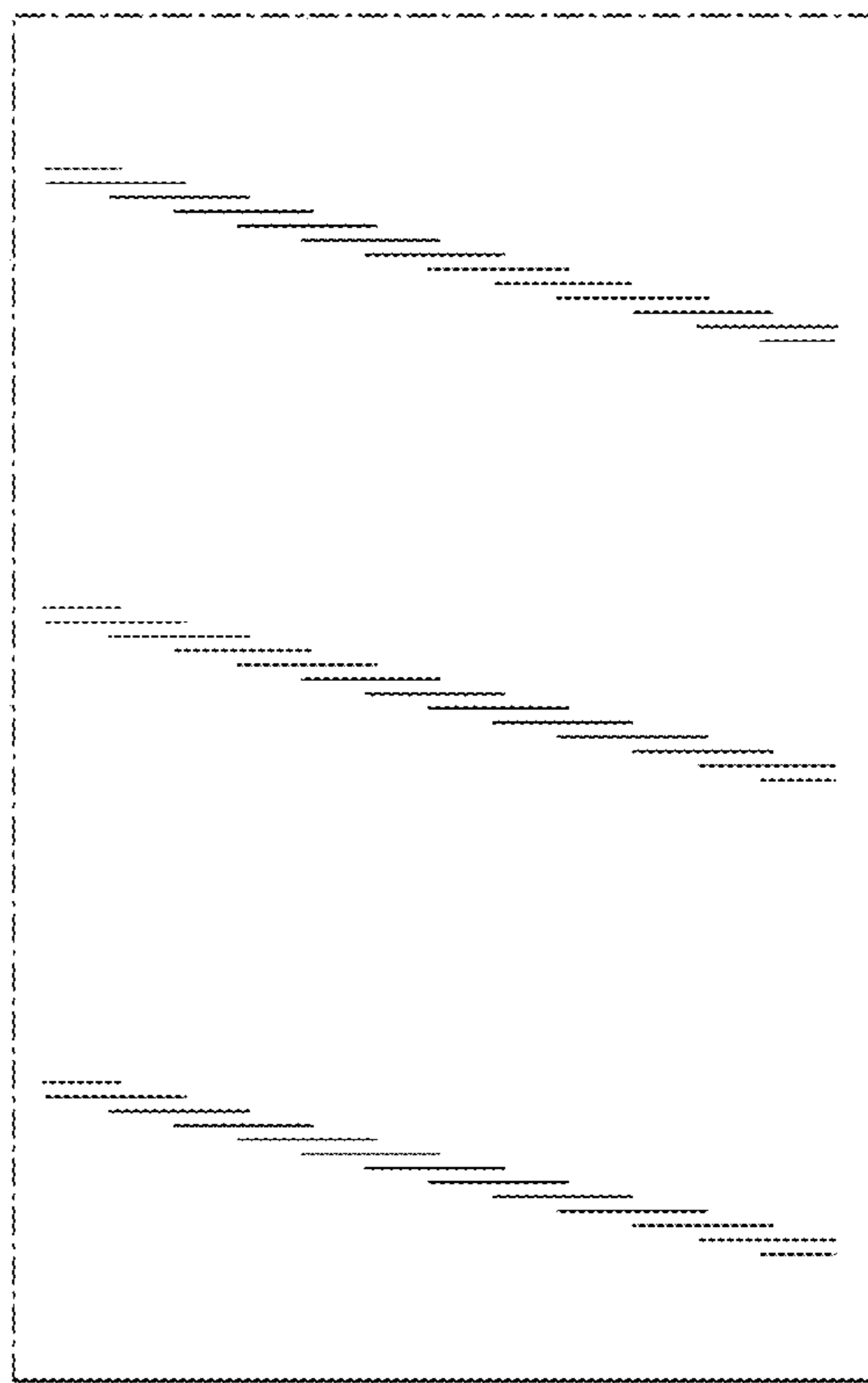

FIG. 3

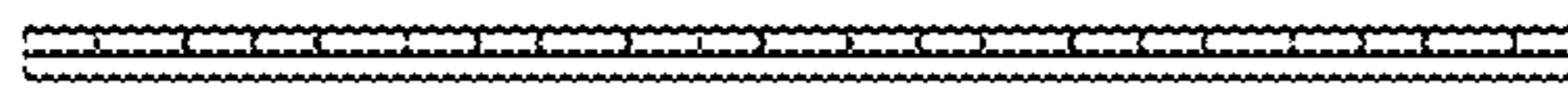

FIG. 4

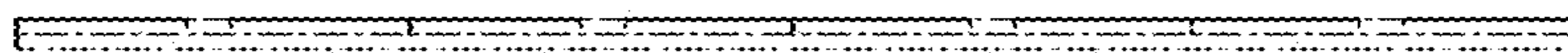

FIG. 5

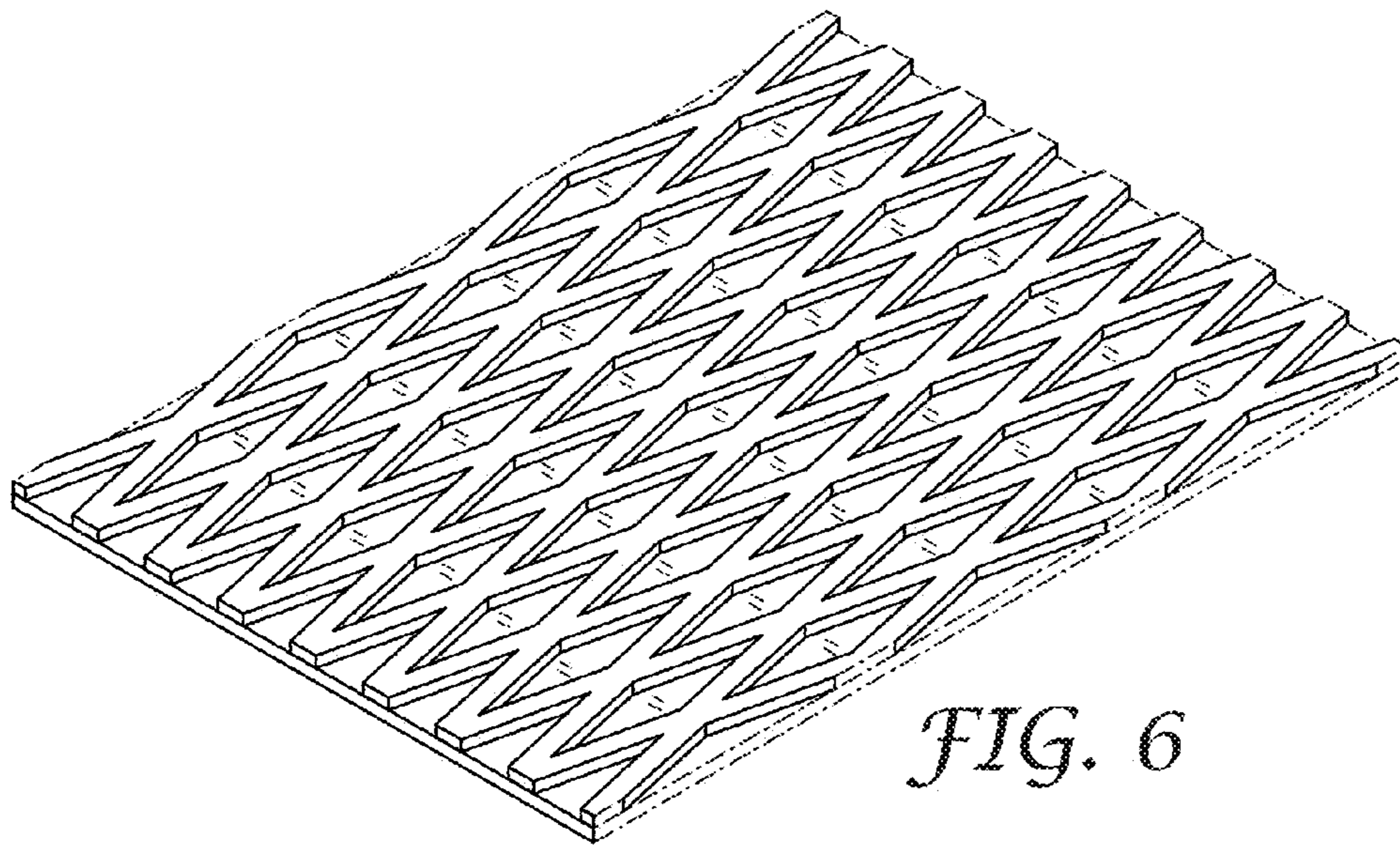

FIG. 6

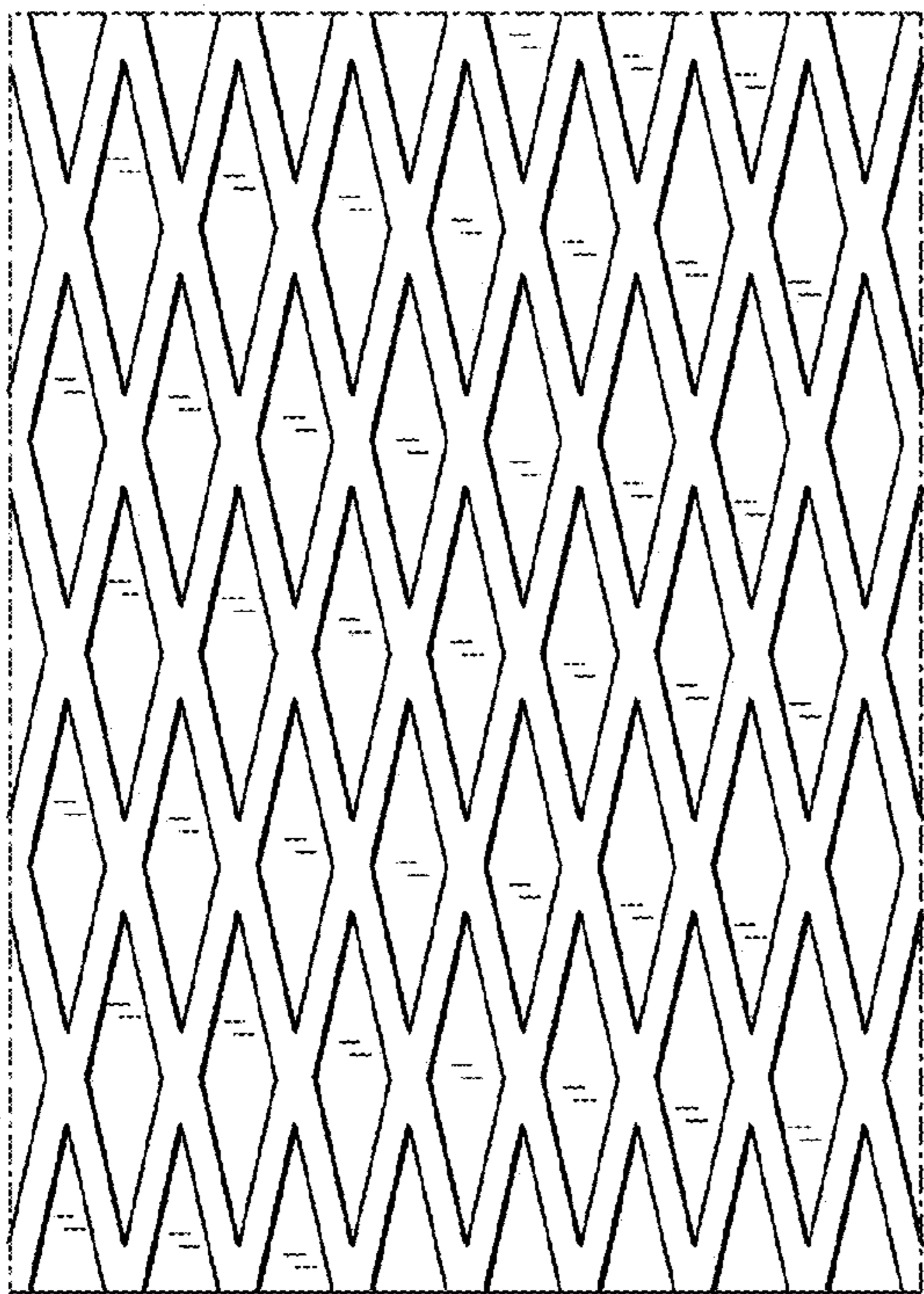

FIG. 7

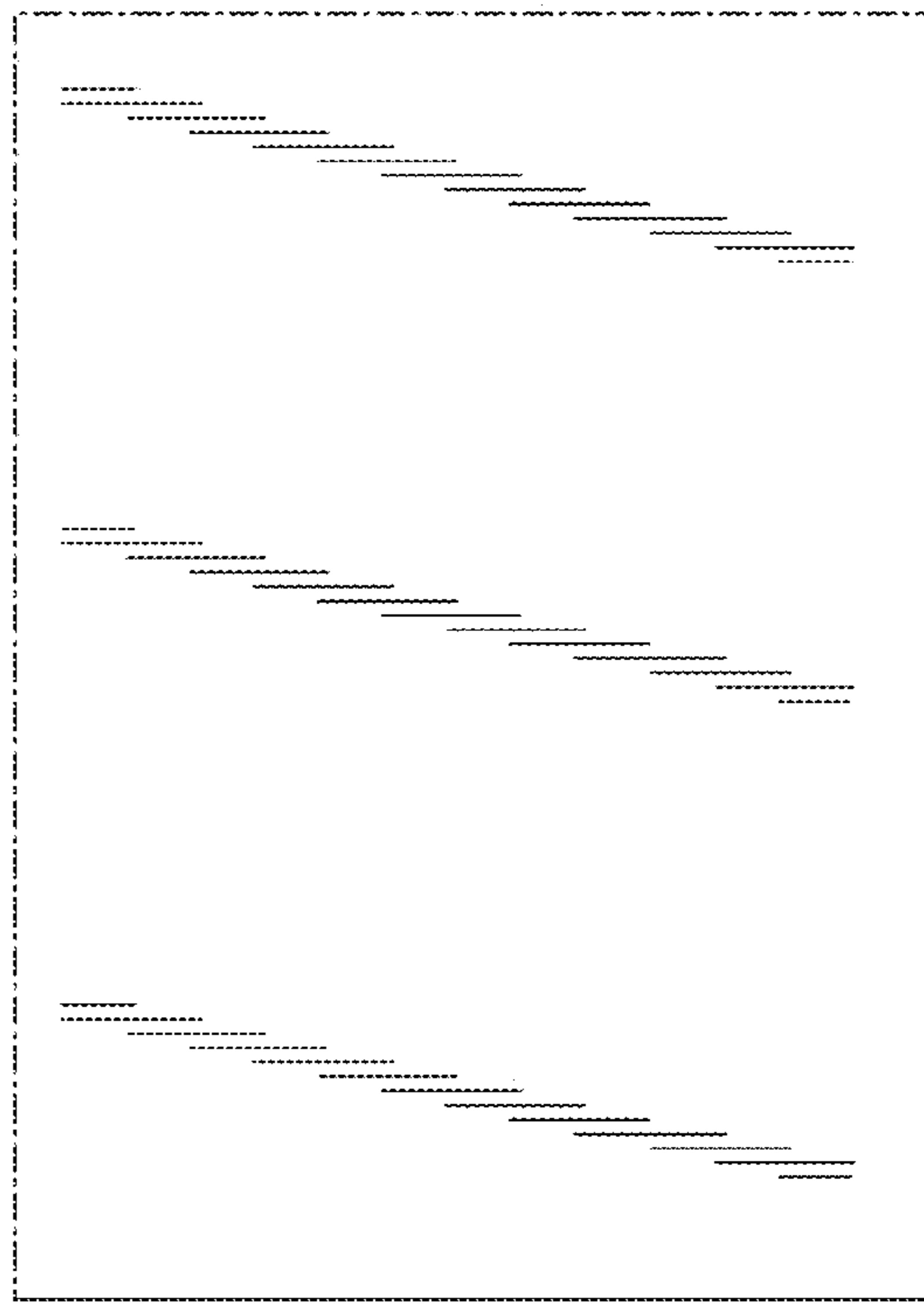

FIG. 8

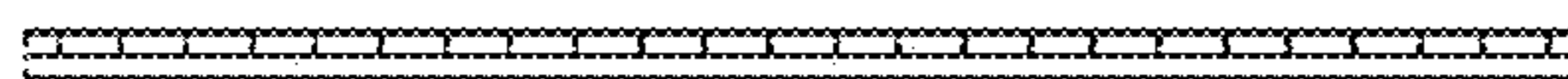

FIG. 9

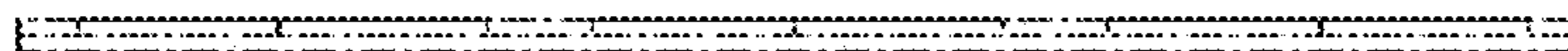

FIG. 10

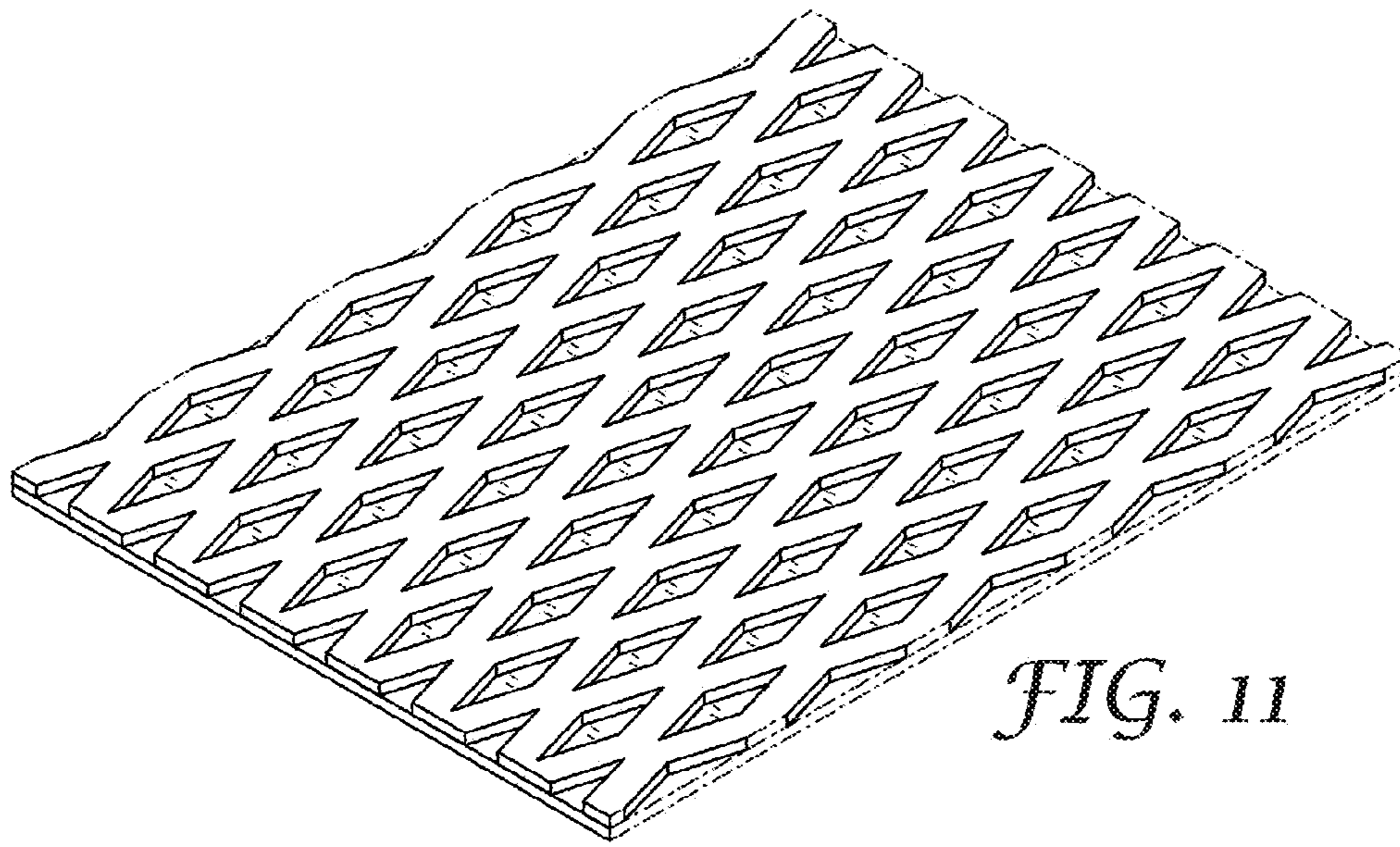

FIG. 11

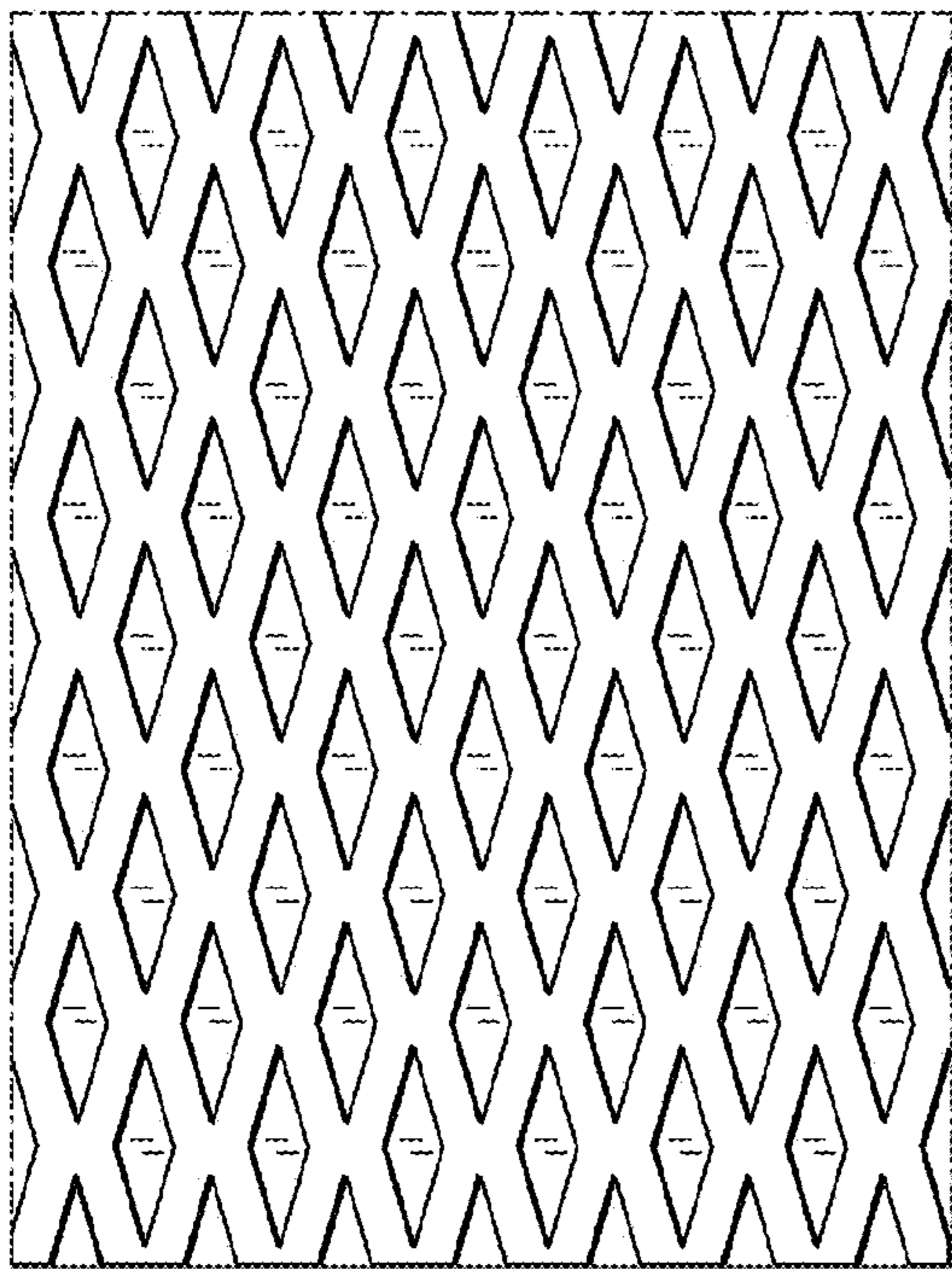

FIG. 12

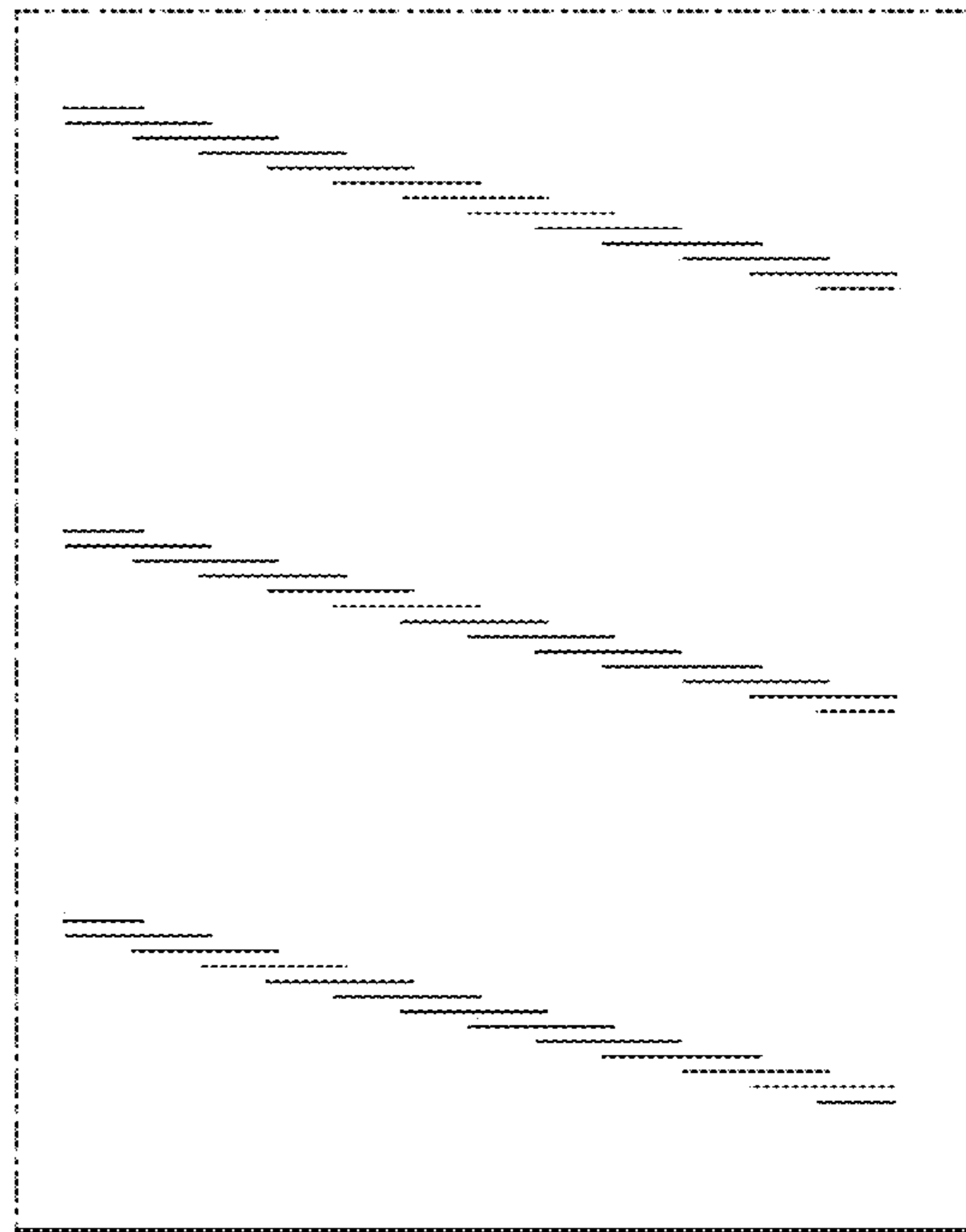

FIG. 13

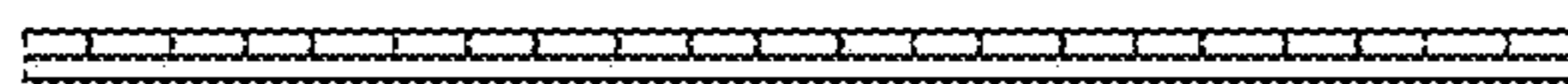

FIG. 14

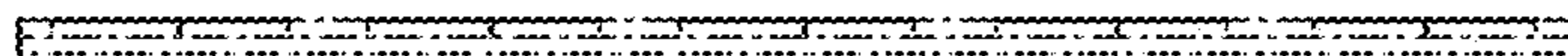

FIG. 15

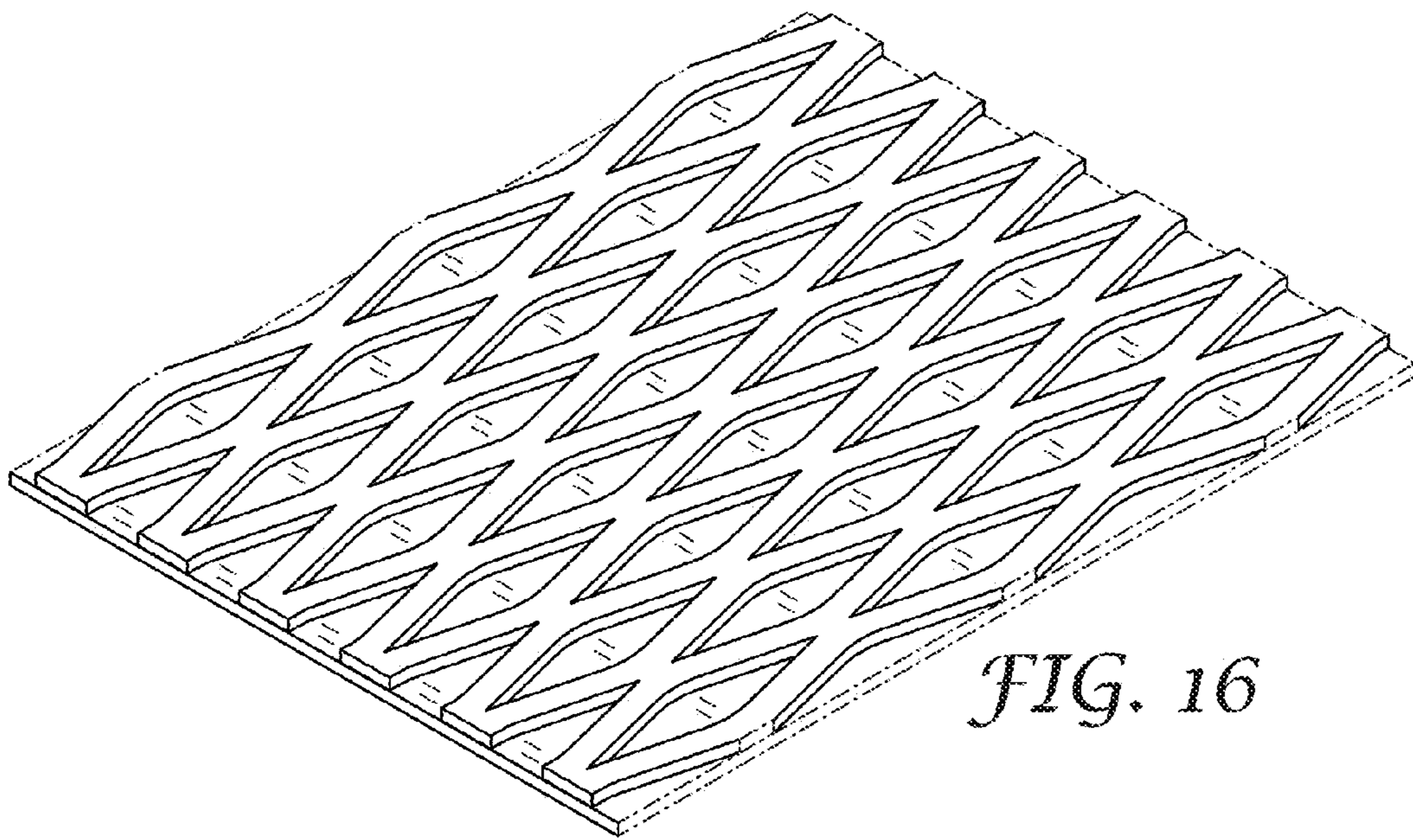

FIG. 16

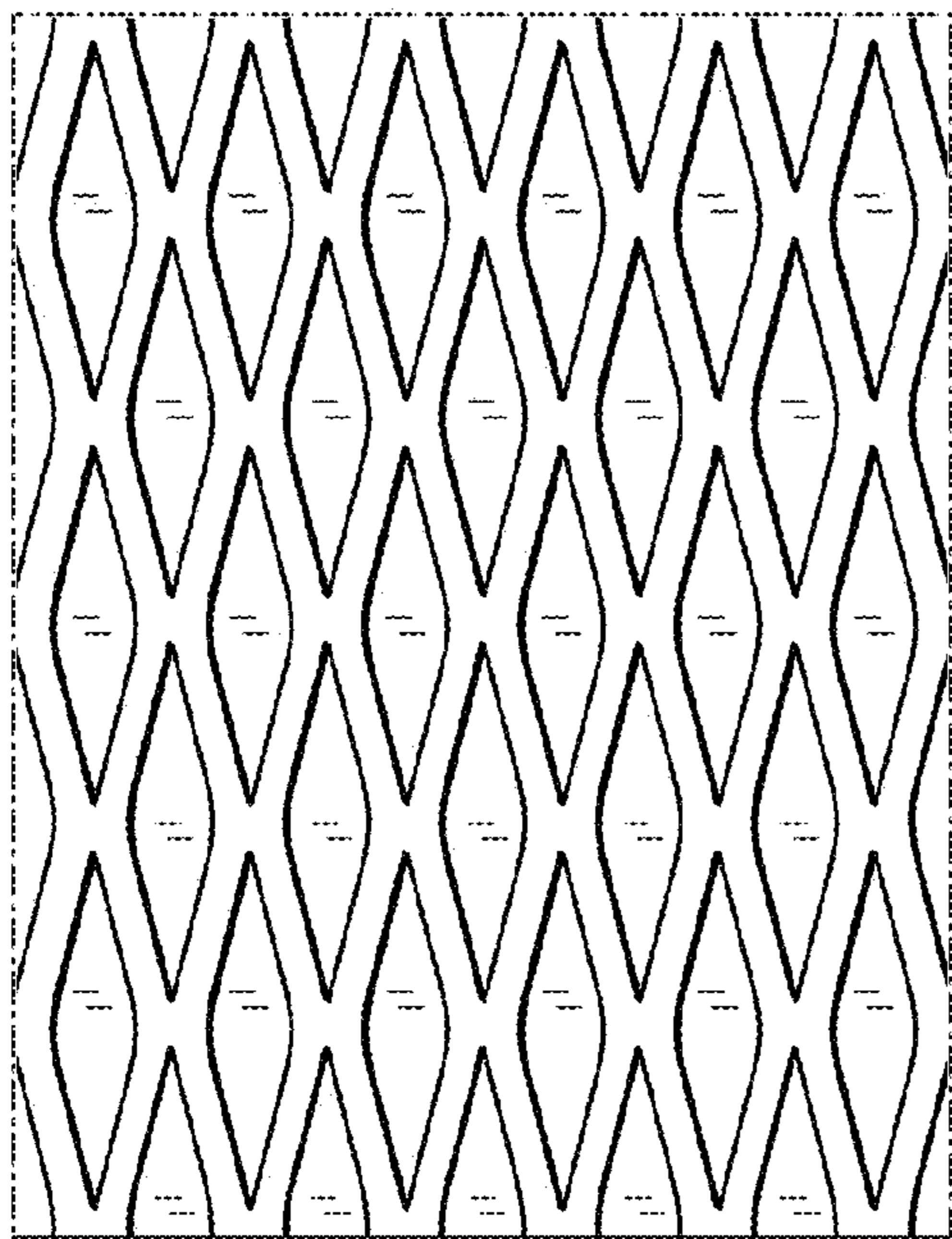

FIG. 17

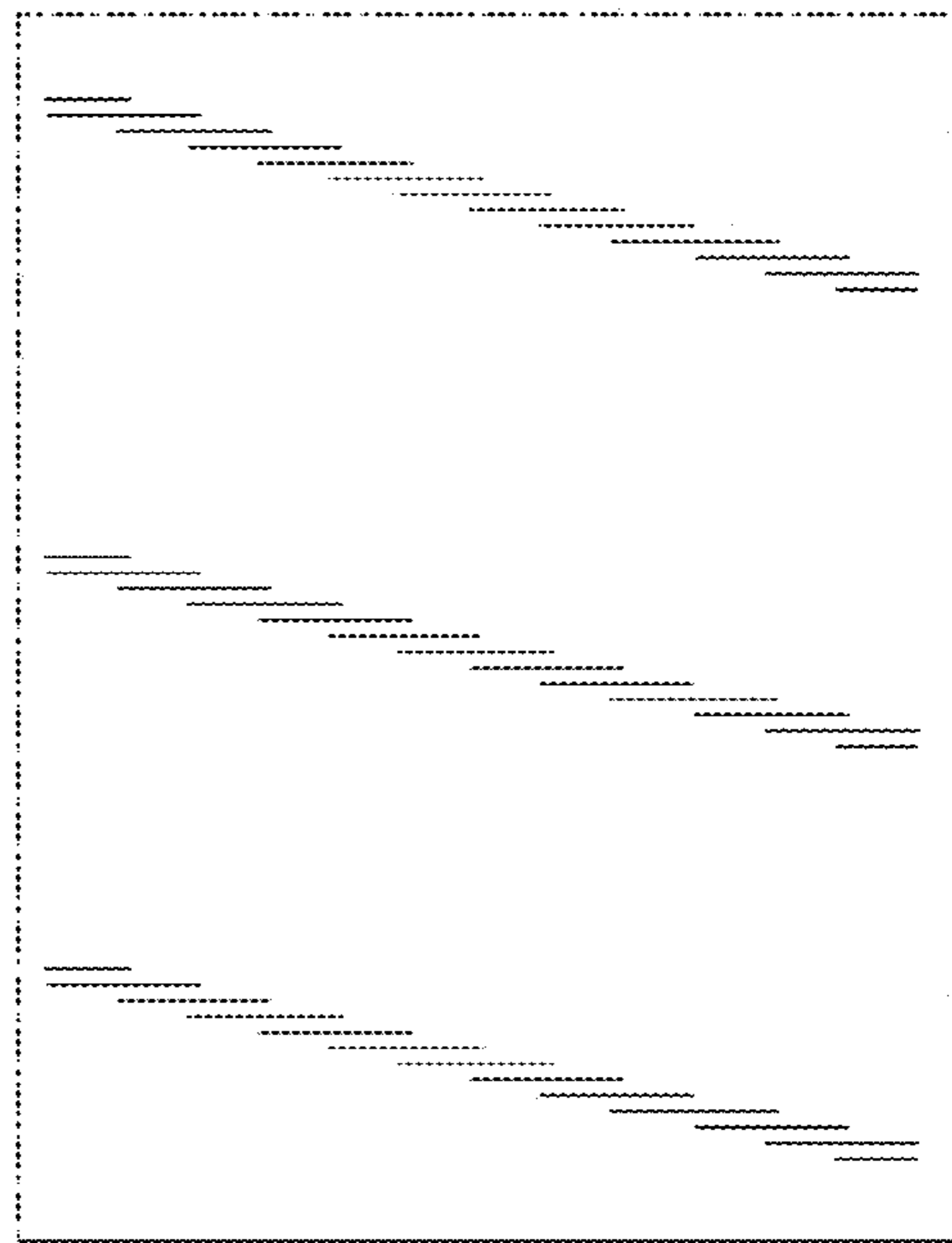

FIG. 18

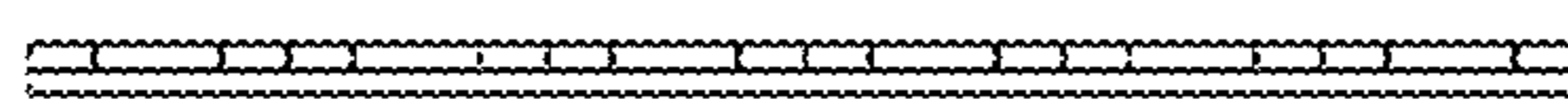

FIG. 19

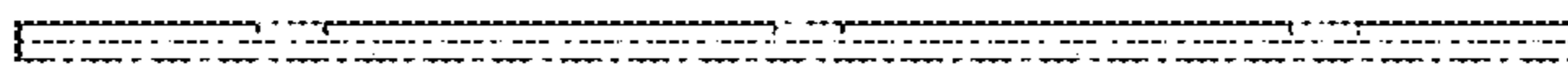

FIG. 20

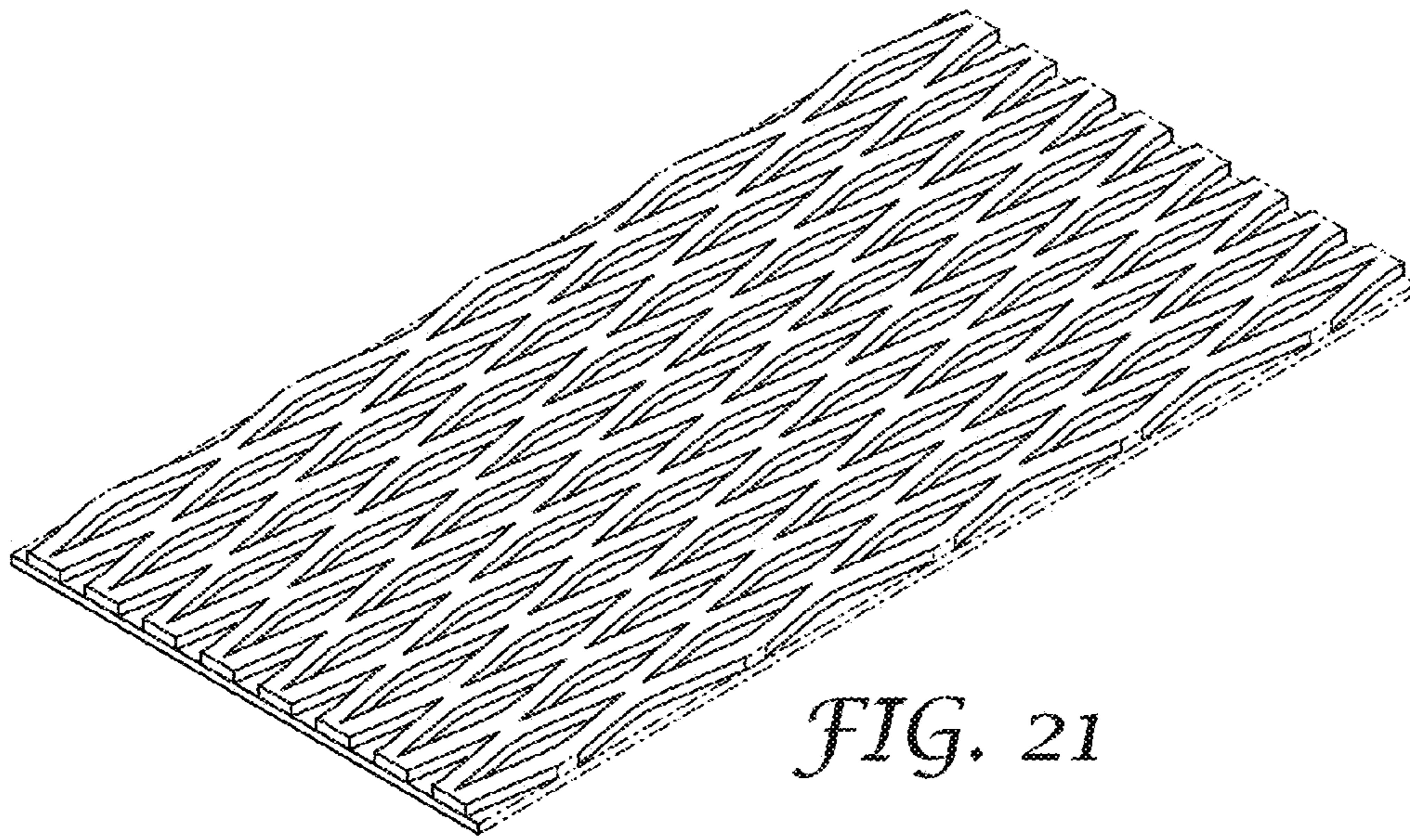

FIG. 21

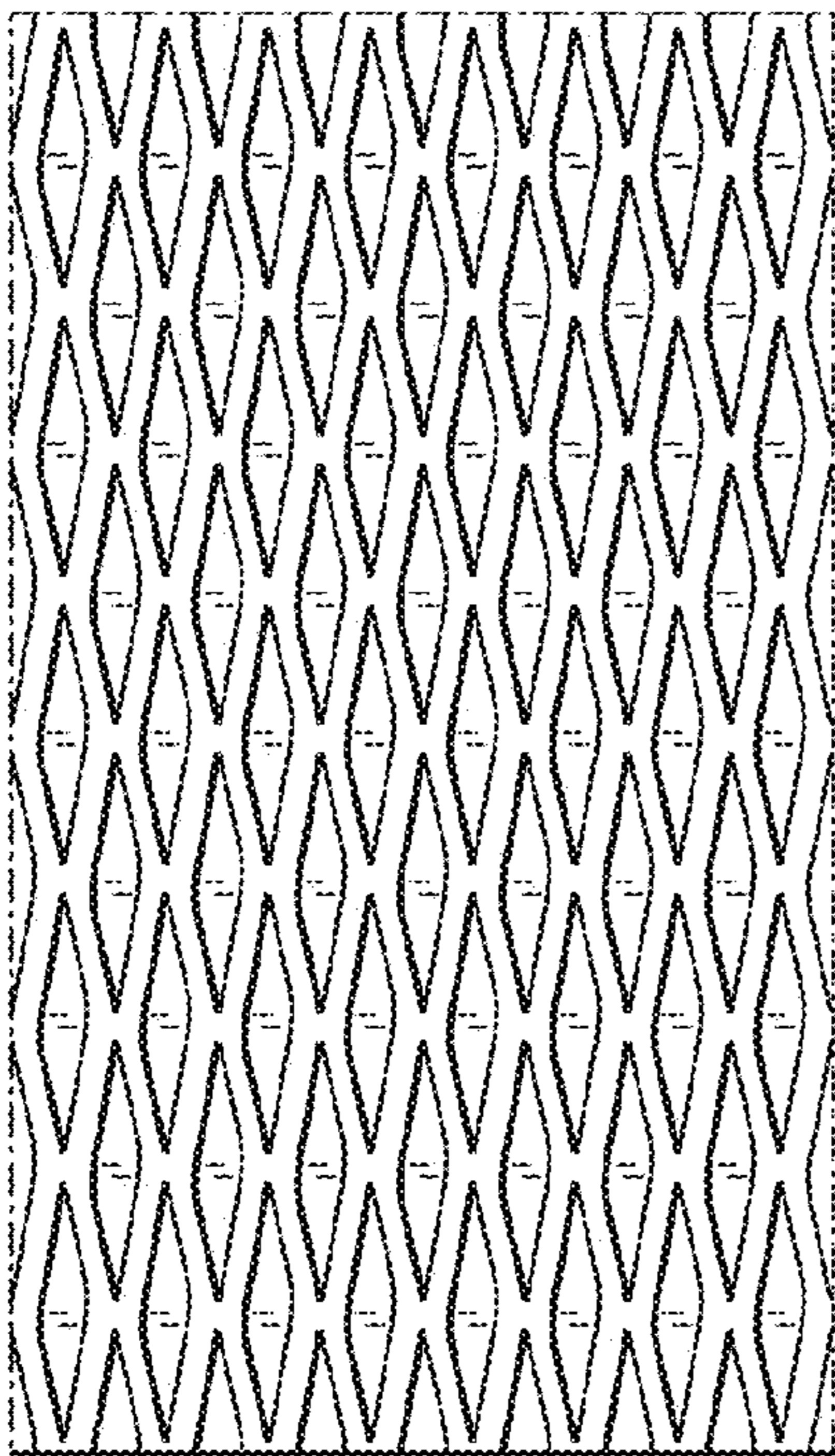

FIG. 22

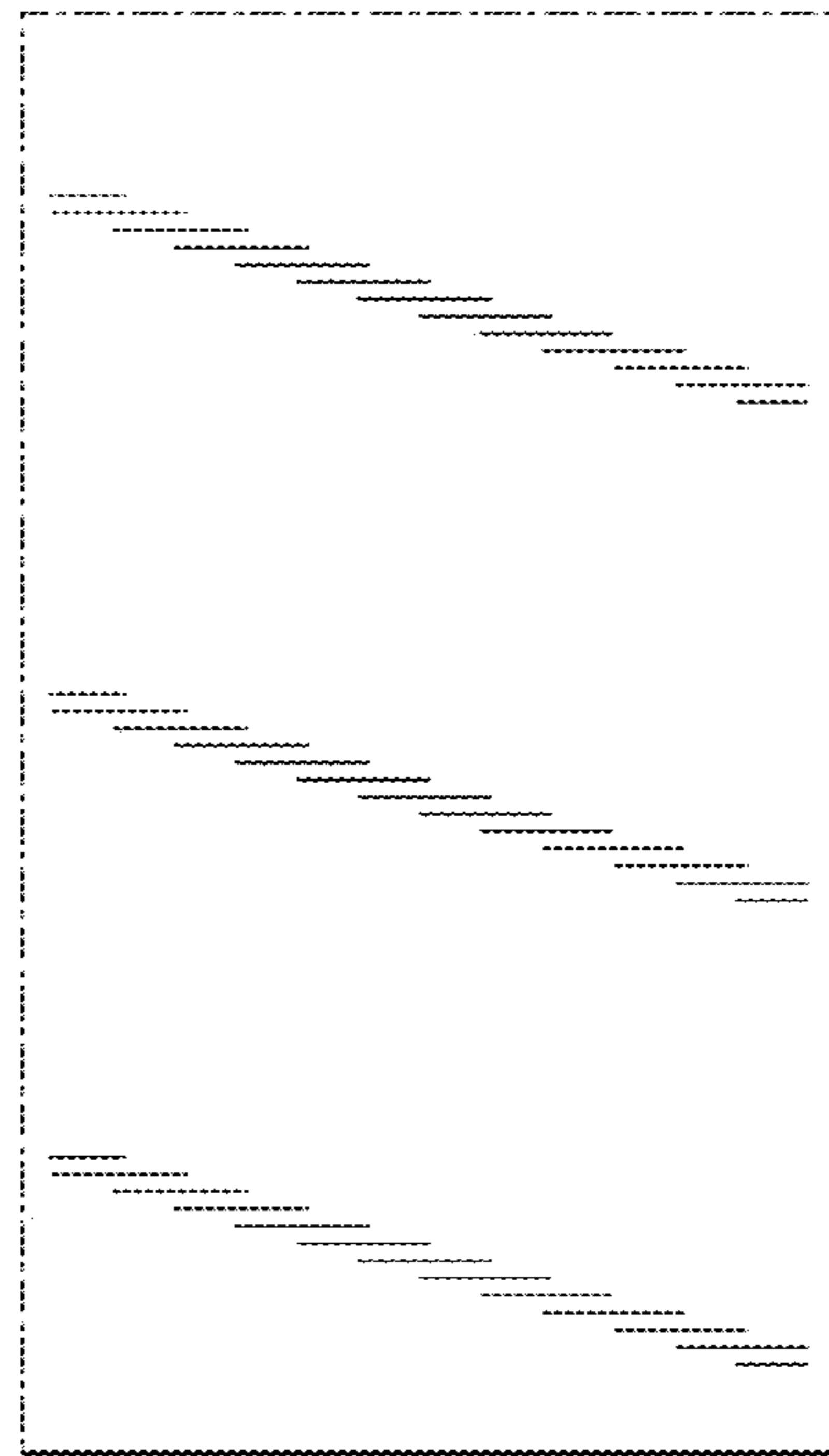

FIG. 23

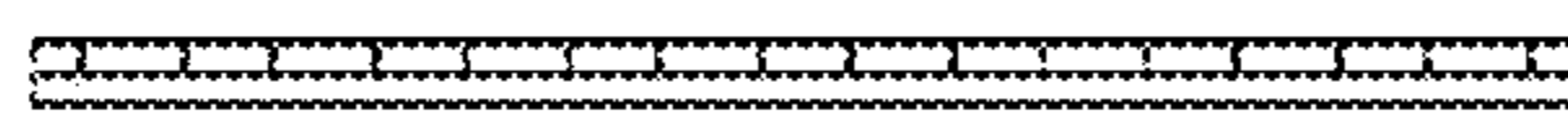

FIG. 24

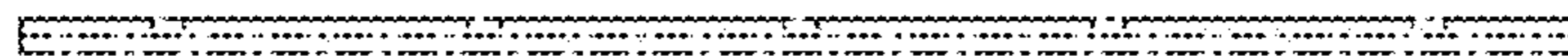

FIG. 25