



US00D965791S

(12) **United States Design Patent**
Zhang

(10) **Patent No.:** **US D965,791 S**

(45) **Date of Patent:** **** Oct. 4, 2022**

(54) **TEETH WHITENING LED LIGHT**

(71) Applicant: **Wei Zhang**, Jiangxi (CN)

(72) Inventor: **Wei Zhang**, Jiangxi (CN)

(73) Assignee: **Jiangxi Zhuichi Technology Co., Ltd.**,
Jiangxi (CN)

(**) Term: **15 Years**

(21) Appl. No.: **29/769,762**

(22) Filed: **Feb. 8, 2021**

(51) **LOC (13) Cl.** **28-03**

(52) **U.S. Cl.**
USPC **D24/176**

(58) **Field of Classification Search**
USPC D24/108, 111, 152, 176, 178, 180–182;
D4/101; D29/108
CPC A61C 19/063; A61C 19/06; A61C 19/066;
A61N 5/06; A61N 2005/0606
See application file for complete search history.

(56) **References Cited**

U.S. PATENT DOCUMENTS

| | | | | |
|-------------------|---------|----------|-------|-------------|
| D713,531 S * | 9/2014 | Way | | A61N 5/0613 |
| | | | | D24/181 |
| D795,440 S * | 8/2017 | Way | | D24/181 |
| D864,399 S * | 10/2019 | Qin | | D24/176 |
| D867,598 S * | 11/2019 | Qin | | D24/176 |
| D869,855 S * | 12/2019 | Khayat | | D4/101 |
| D881,583 S * | 4/2020 | Huang | | D4/101 |
| D887,017 S * | 6/2020 | Liu | | D24/181 |
| D895,808 S * | 9/2020 | Li | | D24/176 |
| D899,600 S * | 10/2020 | Li | | D24/176 |
| D908,890 S * | 1/2021 | Demarest | | D24/176 |
| D912,826 S * | 3/2021 | Bao | | D24/176 |
| D933,839 S * | 10/2021 | Ou | | D24/181 |
| D939,091 S * | 12/2021 | Pai | | D24/181 |
| D940,328 S * | 1/2022 | Demarest | | D24/181 |
| D948,033 S * | 4/2022 | Fang | | D24/111 |
| 2017/0173354 A1 * | 6/2017 | Demarest | | A61N 5/0613 |

| | | | | |
|-------------------|--------|----------|-------|-------------|
| 2019/0151059 A1 * | 5/2019 | Otsuka | | A61C 19/066 |
| 2020/0114167 A1 * | 4/2020 | Bloch | | A61N 5/062 |
| 2021/0100645 A1 * | 4/2021 | Speicher | | A61C 19/06 |

FOREIGN PATENT DOCUMENTS

| | | | |
|----|----------------|---|--------|
| CN | 306386175 | * | 3/2021 |
| EM | 008473383-0001 | * | 3/2021 |

OTHER PUBLICATIONS

[Teeth Whitening Kit with Led Light, RENPHO 16 LED Accelerator Light Teeth Whitening Kit for Sensitive Teeth Whitener, 4x4ml Non-Sensitive Gels, 35% Carbamide Peroxide, Mouth Tray, Smartphone Adapter], ubuy.co.id, Date First Available: Sep. 27, 2020 [online], Customer Review Oldest Date: Aug. 10, 2020 [online], site visited: [May 17, 2022], URL: <https://www.ubuy.co.id/en/product/BRRPLAO-teeth-whitening-kit-with-led-light-renpho-16-led-accelerator-light-teeth-whitening-kit-for-sensitive>. (Year: 2020).*

* cited by examiner

Primary Examiner — Jonathan J Han

Assistant Examiner — Amanda J Berlinski

(57) **CLAIM**

The ornamental design for a teeth whitening LED light, as shown and described.

DESCRIPTION

FIG. 1 is a perspective view of a teeth whitening LED light showing my new design;
FIG. 2 is a front elevation view thereof;
FIG. 3 is a rear elevation view thereof;
FIG. 4 is a left side elevation view thereof;
FIG. 5 is a right side elevation view thereof;
FIG. 6 is a top plan view thereof; and,
FIG. 7 is a bottom plan view thereof.
The broken lines shown in the figures depict portions of the teeth whitening LED light that form no part of the claimed design.

1 Claim, 7 Drawing Sheets

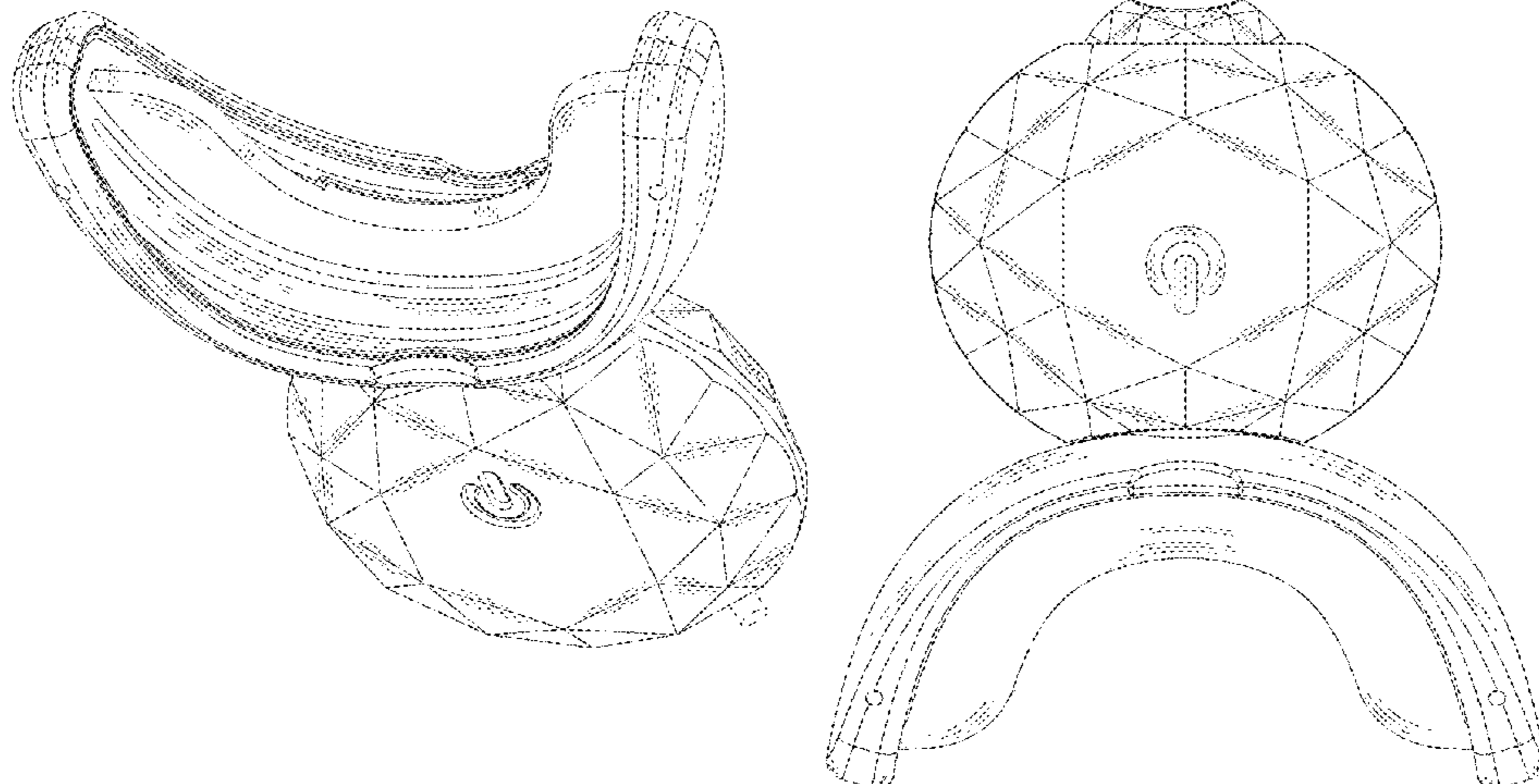

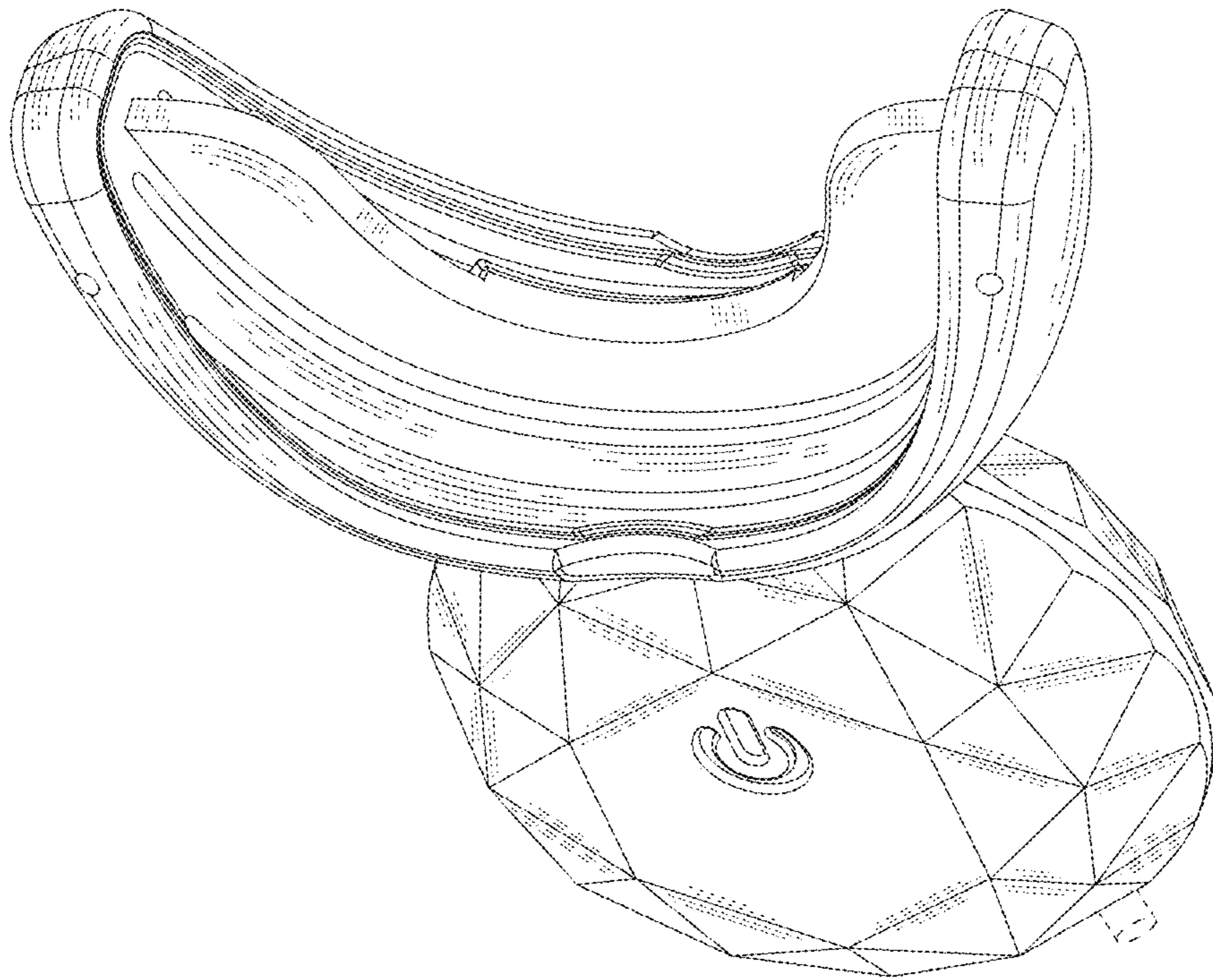

FIG.1

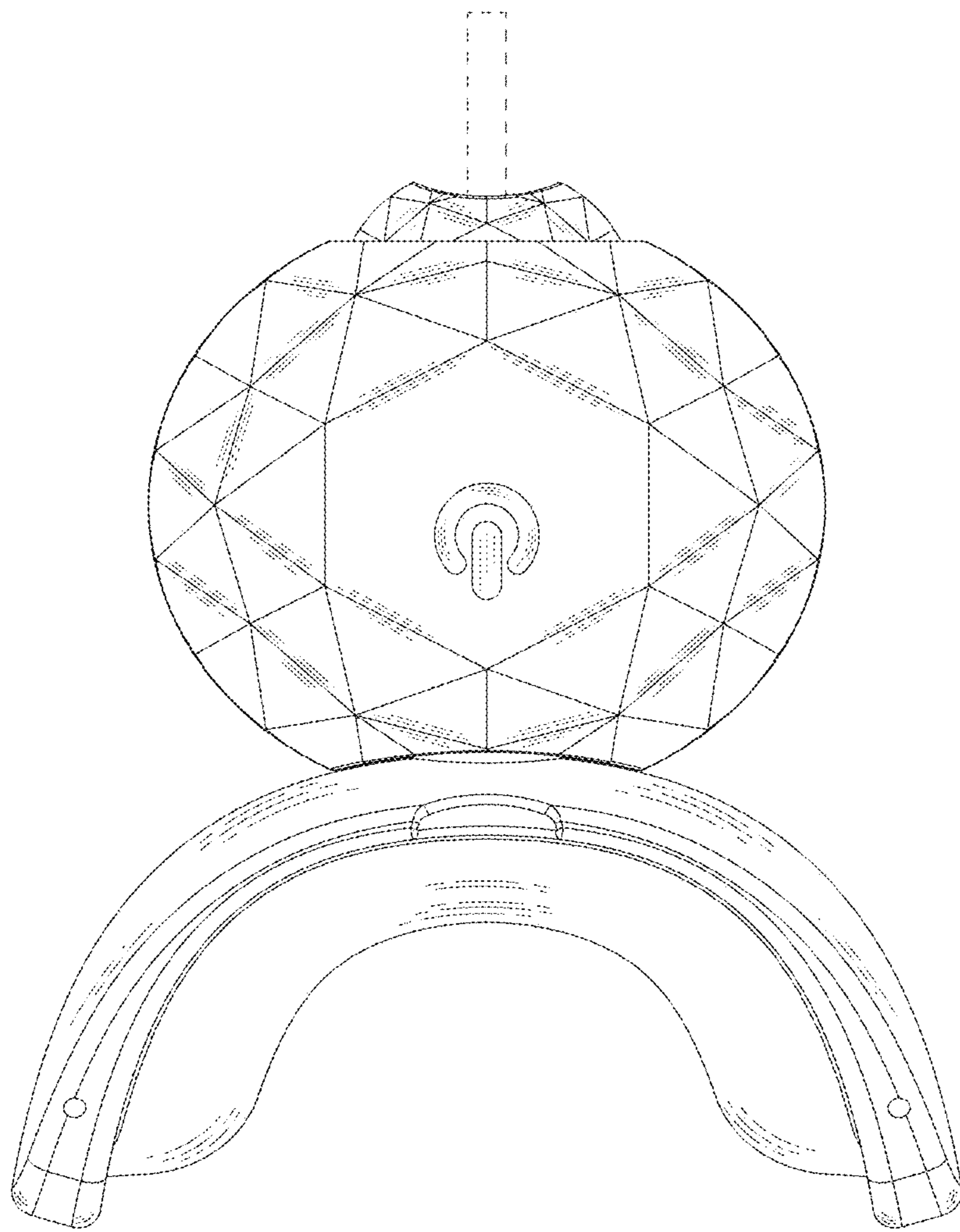

FIG.2

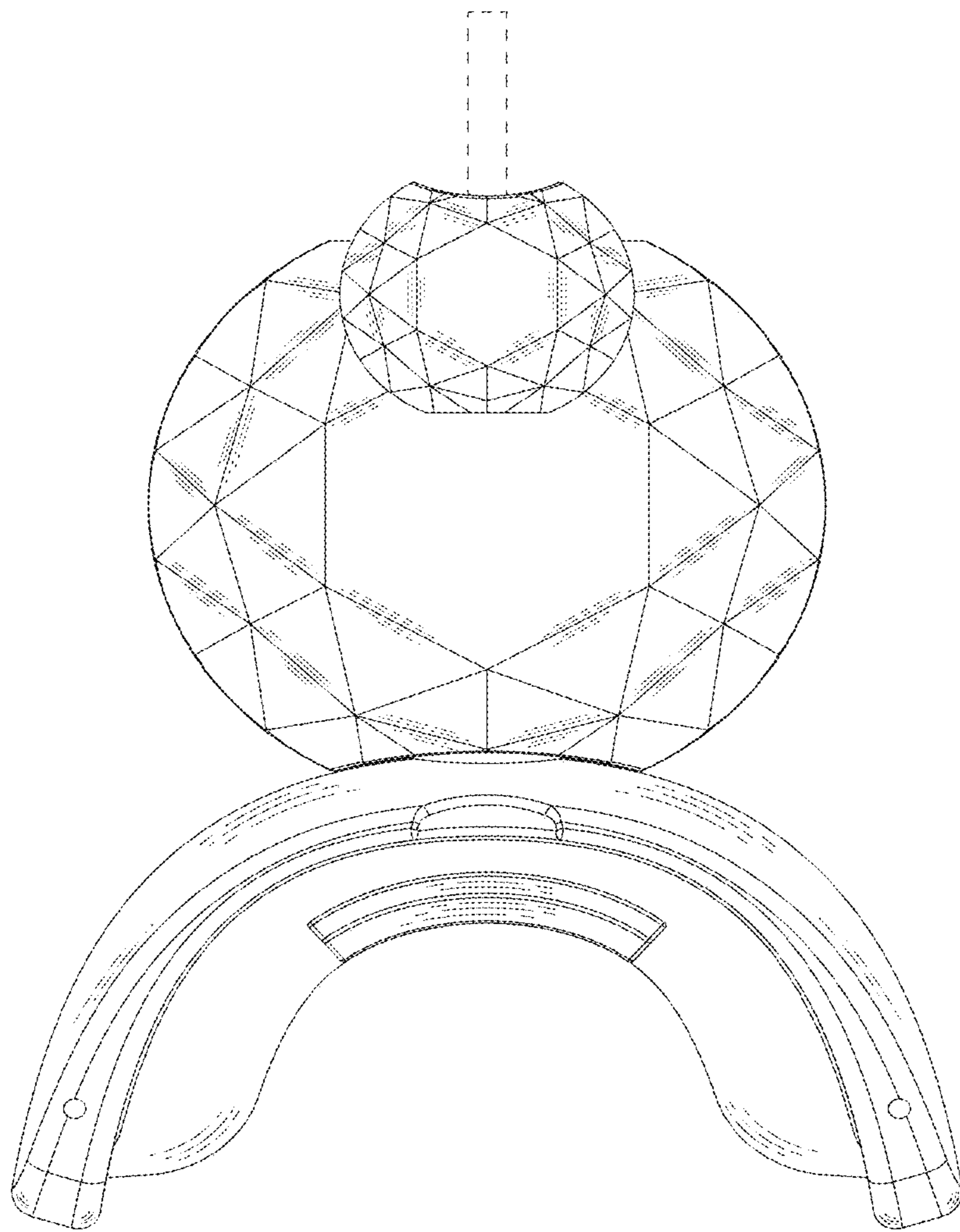

FIG.3

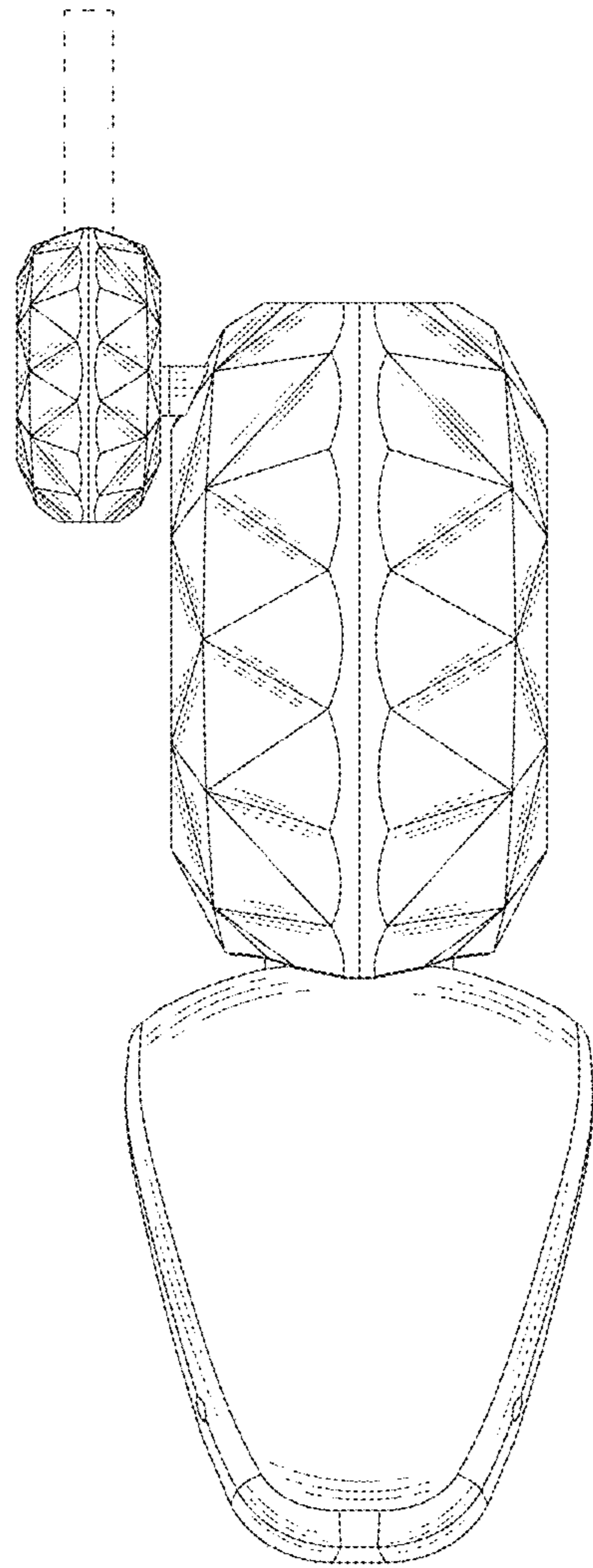

FIG.4

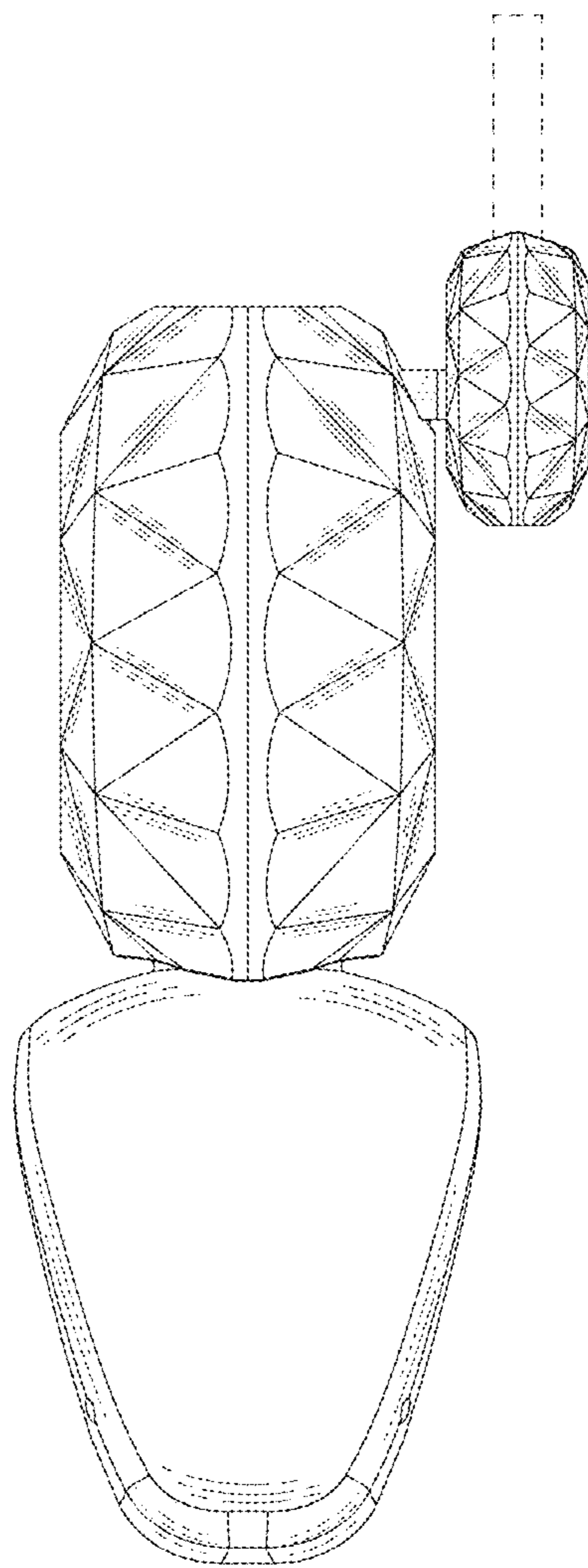

FIG.5

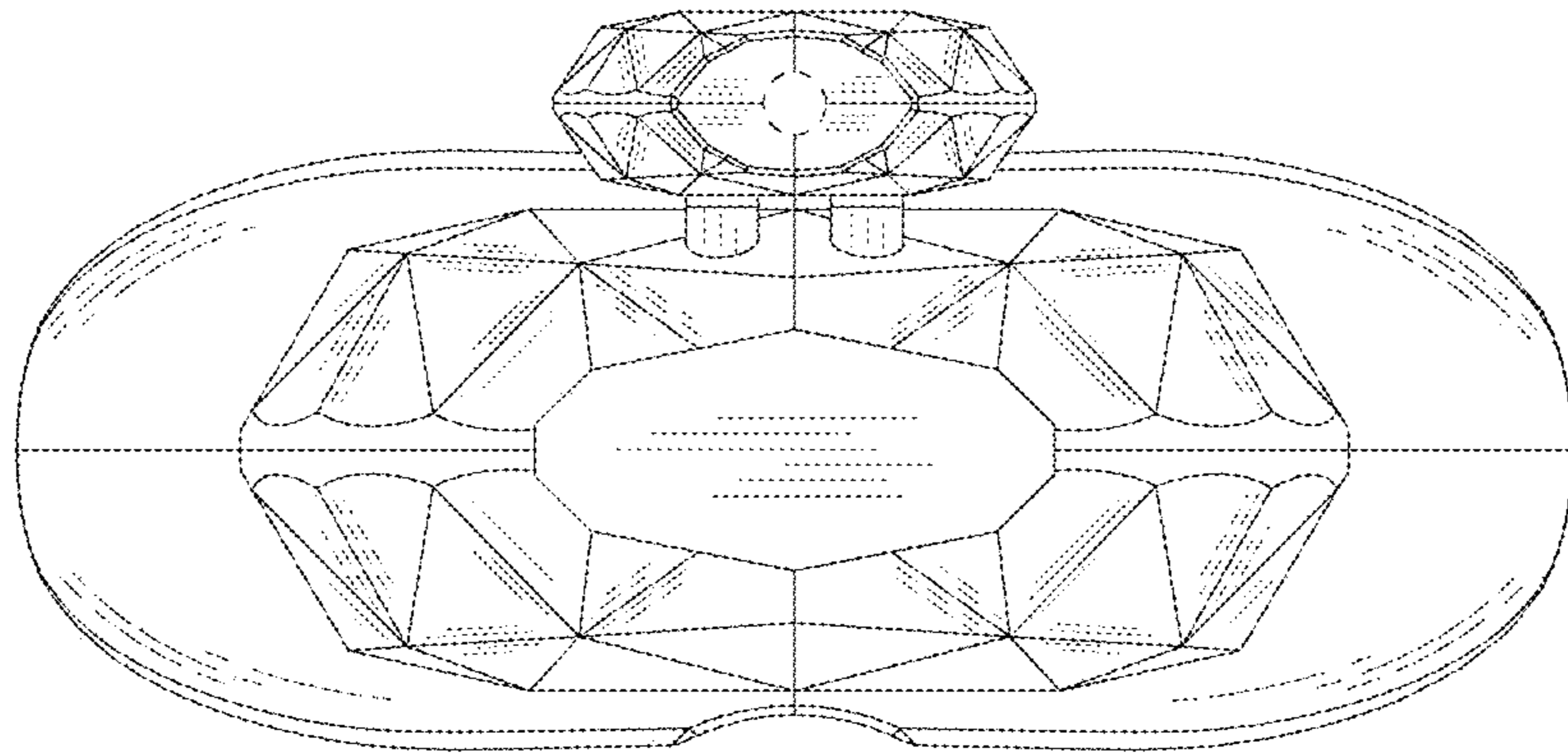

FIG.6

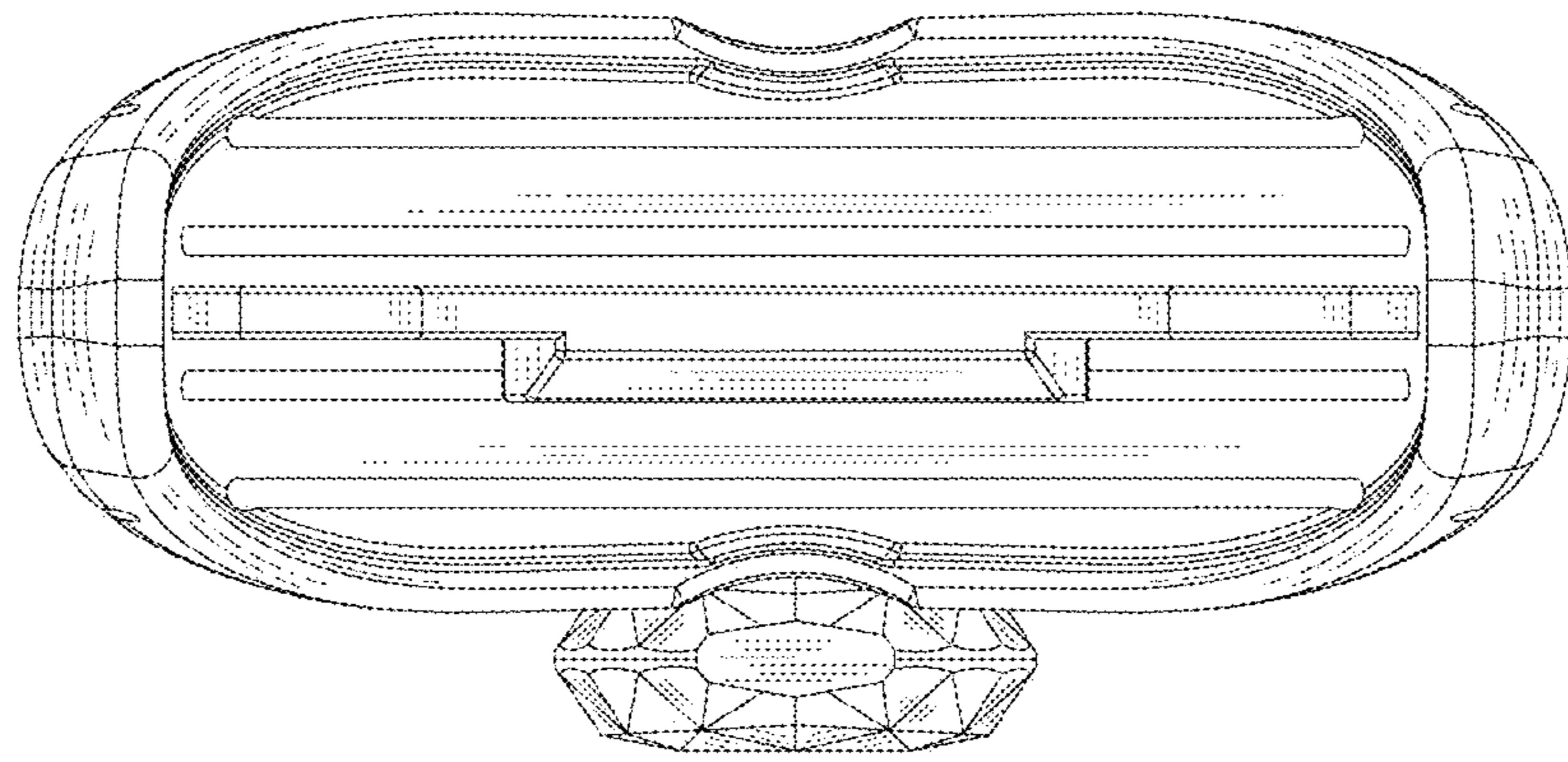

FIG. 7