

US00D965783S

(12) **United States Design Patent** (10) **Patent No.:** **US D965,783 S**  
**Kurihara et al.** (45) **Date of Patent:** **\*\* Oct. 4, 2022**

(54) **KNIFE FOR SURGICAL PURPOSES**

(71) Applicant: **MANI, INC.**, Tochigi (JP)  
 (72) Inventors: **Hideyuki Kurihara**, Saitama (JP);  
**Takafumi Doi**, Tochigi (JP); **Masayuki Watanabe**, Tochigi (JP)

(\*\*) Term: **15 Years**

(21) Appl. No.: **35/512,050**

(22) Filed: **Dec. 21, 2020**

(80) **Hague Agreement Data**

Int. Filing Date: **Dec. 21, 2020**  
 Int. Reg. No.: **DM/212515**  
 Int. Reg. Date: **Dec. 21, 2020**  
 Int. Reg. Pub. Date: **Jun. 25, 2021**

(30) **Foreign Application Priority Data**

Jun. 22, 2020 (JP) ..... 2020-012426  
 Jun. 22, 2020 (JP) ..... 2020-012427

(51) **LOC (13) Cl.** ..... **24-02**

(52) **U.S. Cl.**  
USPC ..... **D24/146**

(58) **Field of Classification Search**  
 USPC ..... D24/144, 146, 147, 152; D22/125, 126;  
 D8/20  
 CPC .. A61B 17/320016; A61B 2017/32113; B65H  
 2701/3918  
 See application file for complete search history.

(56) **References Cited**

**U.S. PATENT DOCUMENTS**

D32,481 S \* 4/1900 Berger ..... D7/693  
 2,070,281 A \* 2/1937 Leggiadro ..... A61B 17/1624  
 606/177  
 D165,958 S \* 2/1952 Black ..... D24/146  
 2,767,703 A \* 10/1956 Nieburgs ..... A61B 10/04  
 600/562

(Continued)

**OTHER PUBLICATIONS**

“Sickle knife, 7 ½”, curved, sharp 10.0mm blade, flat handle”  
 [online]. Ambler Surgical. [Retrieved on Jul. 15, 2022]. Retrieved  
 from the Internet: <<https://amblersurgical.com/39-912-sickle-knife-7-1-2-curved-sharp-10-0mm-blade-flat-handle>>.\*

(Continued)

*Primary Examiner* — Mojtaba Tehrani

(57) **CLAIM**

The ornamental design for a knife for surgical purposes, as shown and described.

**DESCRIPTION**

1. Knife for surgical purposes
2. Knife for surgical purposes
  - 1.1 : Front
  - 1.2 : Top
  - 1.3 : Bottom
  - 1.4 : Left
  - 1.5 : Right
  - 1.6 : Enlarged left view
  - 1.7 : Enlarged right view
  - 2.1 : Front
  - 2.2 : Top
  - 2.3 : Bottom
  - 2.4 : Left
  - 2.5 : Right
  - 2.6 : Enlarged left view
  - 2.7 : Enlarged right view

Designs 1 and 2: broken lines form no part of the claimed designs; rear views are omitted because they are symmetrical to the front views of each design; the knife of each design has the blade bent at a desired angle with respect to the axial direction of the handle thereof; the tip of the blade of design 1 is gently curved so as to match the shape of an eyeball; the blade of design 2 is gently curved as a whole so as to match the shape of an eyeball.

**1 Claim, 14 Drawing Sheets**

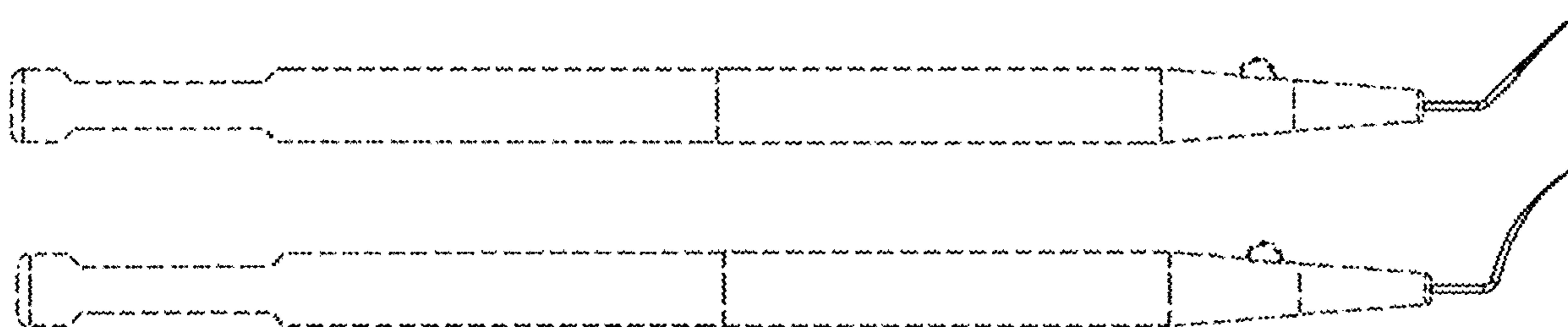

(56)

References Cited

U.S. PATENT DOCUMENTS

3,367,335 A \* 2/1968 Ward ..... A61B 17/3213  
30/329  
3,384,386 A \* 5/1968 Ward ..... A61B 17/3213  
279/93  
D224,672 S \* 8/1972 Geraci ..... D24/151  
D226,735 S \* 4/1973 Navara ..... D7/649  
D232,325 S \* 8/1974 Durden, III ..... D24/170  
D233,077 S \* 10/1974 Heros ..... D24/147  
D233,265 S \* 10/1974 Walchle ..... D24/146  
4,080,737 A \* 3/1978 Fleer ..... A61C 1/088  
D24/146  
D249,062 S \* 8/1978 Crafoord ..... 433/141  
D267,036 S \* 11/1982 Podszus ..... D24/146  
D275,992 S \* 10/1984 Detsch ..... D24/152  
D287,627 S \* 1/1987 Leonard ..... D24/147  
D300,060 S \* 2/1989 Molgaard-Nielsen ..... D24/112  
5,030,228 A \* 7/1991 Wong ..... A61B 17/06066  
606/222  
5,292,330 A \* 3/1994 Shutt ..... A61B 17/320016  
606/167  
5,312,413 A \* 5/1994 Eaton ..... A61F 9/0133  
30/151  
5,443,474 A \* 8/1995 Sfakianos ..... A61B 17/320016  
30/294  
D381,426 S \* 7/1997 Koros ..... D24/147  
D391,361 S \* 2/1998 Evans ..... D24/176  
6,322,581 B1 \* 11/2001 Fukuda ..... A61B 17/06066  
606/222  
D458,682 S \* 6/2002 Szymaitis ..... D24/152  
D463,026 S \* 9/2002 Holms ..... D24/154  
D495,799 S \* 9/2004 Hirsch ..... D24/112  
D535,744 S \* 1/2007 Wright ..... D24/146  
D538,425 S \* 3/2007 Awh ..... D24/146  
D540,945 S \* 4/2007 Darnold ..... D24/146  
D558,346 S \* 12/2007 Darnold ..... D24/152  
D558,347 S \* 12/2007 Darnold ..... D24/152  
D565,733 S \* 4/2008 Andre ..... D24/146  
D571,008 S \* 6/2008 Wu ..... D24/135  
D571,467 S \* 6/2008 Wu ..... D24/135  
D571,468 S \* 6/2008 Wu ..... D24/135  
D571,913 S \* 6/2008 Wu ..... D24/135  
D612,049 S \* 3/2010 Baynham ..... D24/146  
D620,109 S \* 7/2010 Darst Rice ..... D24/146  
D621,940 S \* 8/2010 Kagawa ..... D24/152  
D622,851 S \* 8/2010 Horton ..... D24/147  
D636,490 S \* 4/2011 Koros ..... D24/147  
D637,720 S \* 5/2011 Folwaczny ..... D24/144  
D642,680 S \* 8/2011 Brucker ..... D24/147  
D652,924 S \* 1/2012 Noshiro ..... D24/146  
D660,429 S \* 5/2012 Dauphin ..... D24/146

D660,966 S \* 5/2012 Sheild ..... D24/152  
D669,584 S \* 10/2012 Kawasaki ..... D24/146  
D669,988 S \* 10/2012 Packard ..... D24/147  
D698,922 S \* 2/2014 Kawasaki ..... D24/146  
D715,437 S \* 10/2014 Busch ..... D24/152  
D725,776 S \* 3/2015 Lee ..... D24/147  
D730,519 S \* 5/2015 Arnett ..... D24/146  
D733,298 S \* 6/2015 Mujwid ..... A61F 2/0045  
D24/146  
D736,378 S \* 8/2015 Salehi ..... D24/147  
D745,154 S \* 12/2015 Pace ..... D24/146  
D750,780 S \* 3/2016 Ogane ..... D24/146  
D763,447 S \* 8/2016 Efinger ..... D24/144  
D772,412 S \* 11/2016 Efinger ..... D24/147  
D775,729 S \* 1/2017 Mujwid ..... D24/146  
D782,042 S \* 3/2017 Dexter ..... D24/146  
D785,796 S \* 5/2017 Efinger ..... D24/147  
D802,762 S \* 11/2017 Ogane ..... D24/146  
D820,451 S \* 6/2018 Boge ..... D24/152  
10,568,656 B2 \* 2/2020 Saitoh ..... A61B 17/3211  
D895,114 S \* 9/2020 Cichocki, Jr. .... D24/146  
D895,801 S \* 9/2020 Tanaka ..... D24/152  
D902,404 S \* 11/2020 Patcharakitti ..... D24/146  
D919,807 S \* 5/2021 Javid ..... D24/146  
D921,197 S \* 6/2021 Bravman ..... D24/146  
D922,577 S \* 6/2021 Ayers ..... D24/149  
D922,578 S \* 6/2021 Ayers ..... D24/152  
D938,031 S \* 12/2021 Sivaraman ..... D24/146  
D952,850 S \* 5/2022 Yang ..... D24/147  
D955,577 S \* 6/2022 Sharifi-Mehr ..... D24/146  
2003/0074014 A1 \* 4/2003 Castaneda ..... A61B 17/320016  
606/167  
2010/0023054 A1 \* 1/2010 Matsutani ..... B21J 5/12  
606/223  
2011/0251631 A1 \* 10/2011 Trees ..... A61B 17/3211  
606/167  
2012/0215241 A1 \* 8/2012 Trees ..... A61B 17/3211  
606/167

OTHER PUBLICATIONS

“Arthroscopy surgical knife 1041-1 series” [online]. Endomedium. [Retrieved on Jul. 15, 2022]. Retrieved from the Internet: <<https://www.medicalexpo.com/prod/endomedium/product-128938-956838.html>>.\*  
“Dental Tools, Plaque Remover for Teeth, Professional Dental Hygiene Cleaning Kit, Stainless Steel Tooth Scraper Plaque Tartar Remover Cleaner, Dental Pick Scaler Oral Care Tools Set” [online]. G.CATAACC. [Product first available on Jan. 17, 2018]. Retrieved from the Internet: <<https://www.amazon.com/dp/B078R7ZX1W>>.\*

\* cited by examiner

1.1

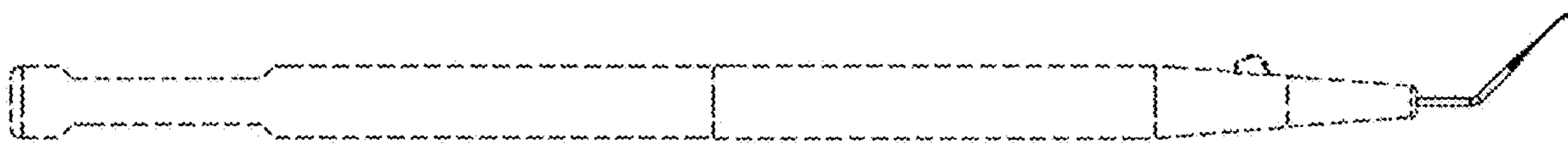

1.2

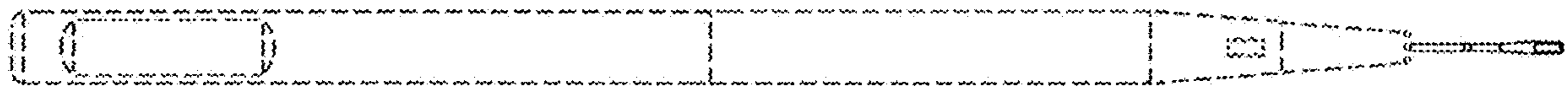

1.3

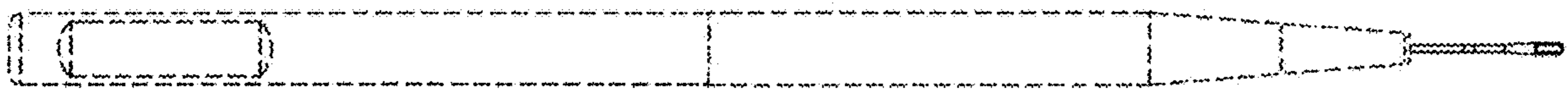

1.4





1.5



1.6

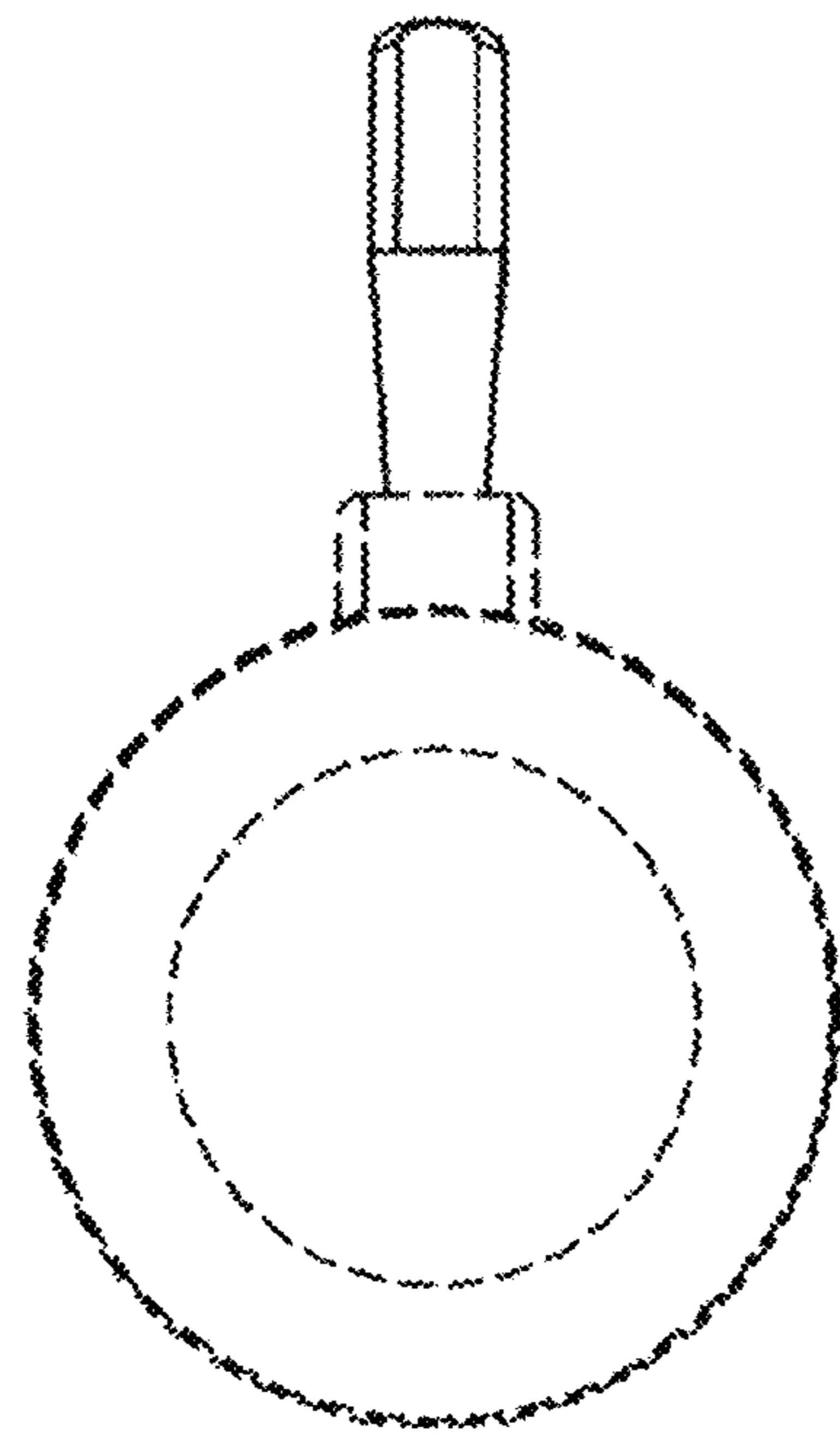



1.7

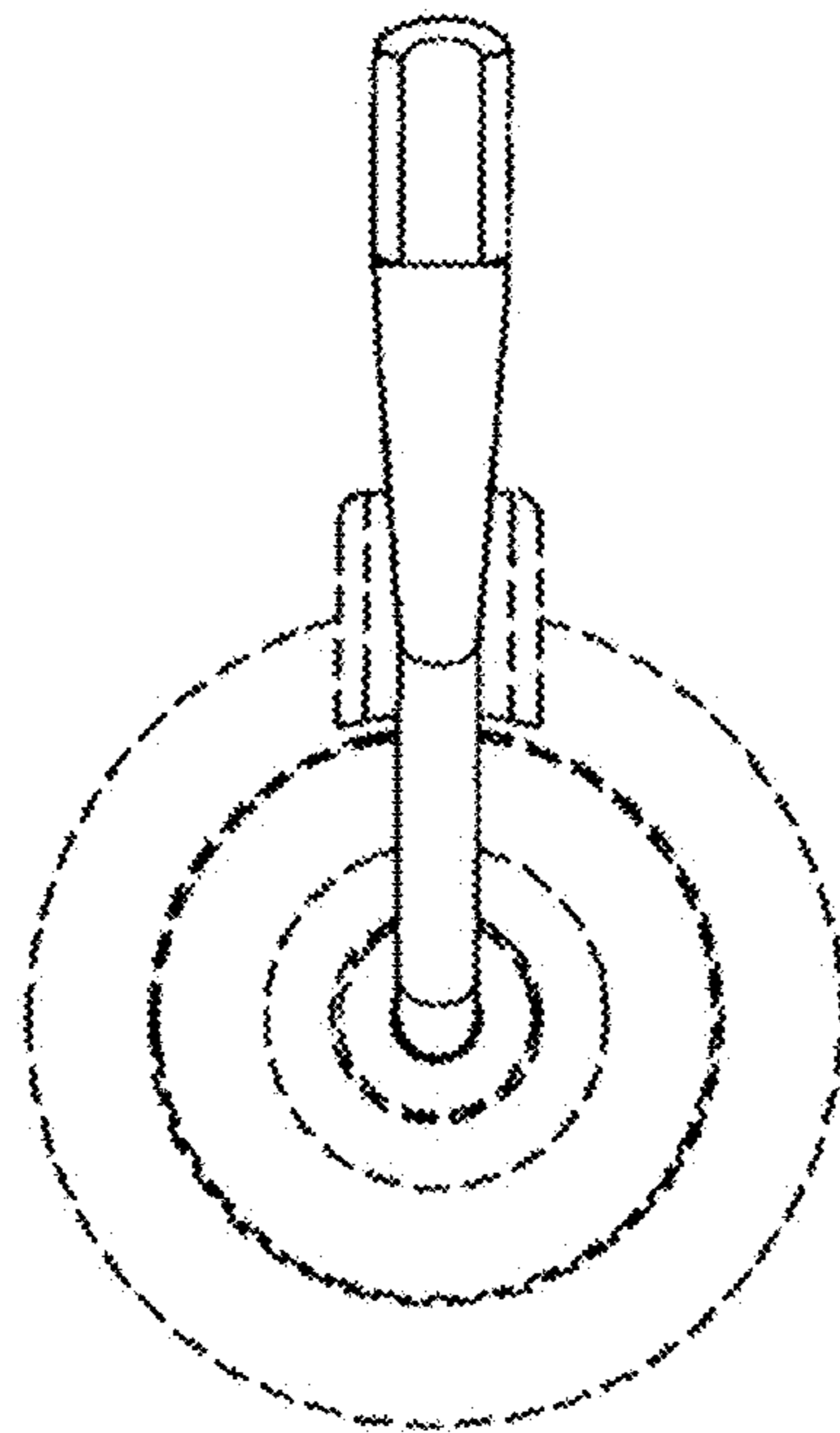

2.1

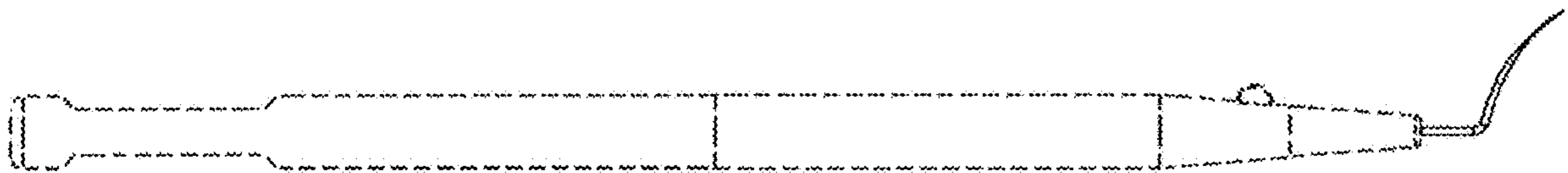

2.2



2.3



2.4



2.5



2.6

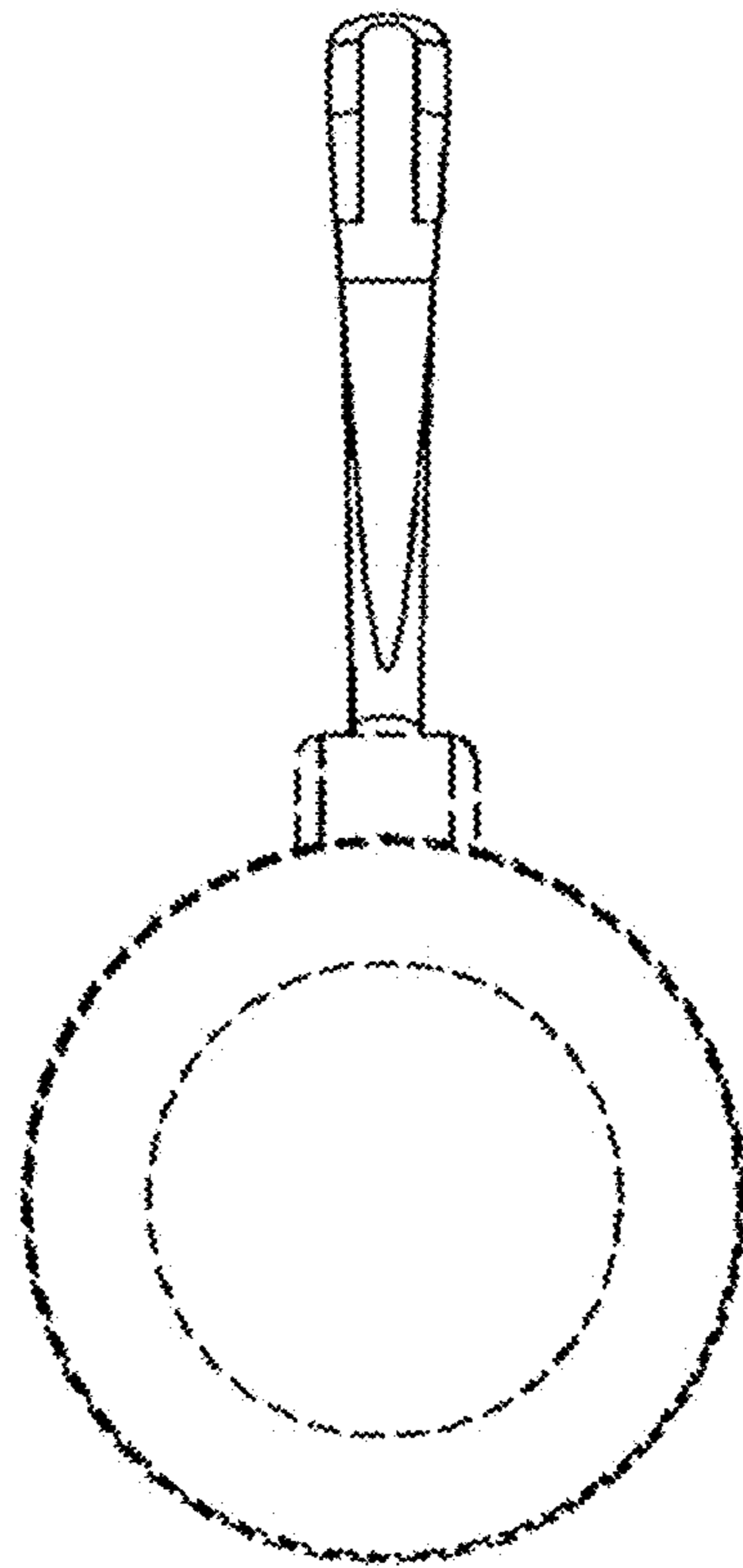



2.7

