



US00D965727S

(12) **United States Design Patent** (10) **Patent No.:** **US D965,727 S**  
**Ribic et al.** (45) **Date of Patent:** **\*\* Oct. 4, 2022**

(54) **SLIDE FOR A FIREARM**  
(71) Applicant: **Shadow Systems LLC**, Plano, TX (US)  
(72) Inventors: **Anthony Joseph Ribic**, Richardson, TX (US); **Richard Trevor Simpson Roe**, Plano, TX (US); **Richard Pederson**, Plano, TX (US)  
(73) Assignee: **Shadow Systems LLC**, Plano, TX (US)  
(\*\*) Term: **15 Years**  
(21) Appl. No.: **29/728,678**  
(22) Filed: **Mar. 20, 2020**  
(51) **LOC (13) Cl.** ..... **22-01**  
(52) **U.S. Cl.**  
USPC ..... **D22/108**  
(58) **Field of Classification Search**  
USPC ..... D22/103, 104, 105, 108; D21/573–575  
CPC .. F41A 9/18; F41A 19/11; F41A 17/54; F41C 3/04; F41C 3/08; F41C 3/16; F41C 7/00; F41C 7/06  
See application file for complete search history.

(56) **References Cited**  
**U.S. PATENT DOCUMENTS**  
D676,094 S \* 2/2013 Hu ..... D22/108  
D681,131 S \* 4/2013 Su ..... D21/574  
D690,374 S \* 9/2013 Lee ..... D21/574  
D758,519 S \* 6/2016 Toner ..... D22/108  
D777,871 S \* 1/2017 Niswander ..... D22/108  
D784,479 S \* 4/2017 Niswander ..... D22/108  
D800,243 S \* 10/2017 Niswander ..... D22/108  
D808,487 S \* 1/2018 Beville ..... D22/104  
D823,969 S \* 7/2018 Seville ..... D22/104  
D828,881 S \* 9/2018 Lee ..... D21/574  
D828,892 S \* 9/2018 Kellgren ..... D22/104  
D830,480 S \* 10/2018 Chu ..... D21/574  
D839,970 S \* 2/2019 Chu ..... D21/574  
D839,971 S \* 2/2019 Chu ..... D21/574

D849,174 S \* 5/2019 Seville ..... D22/104  
D854,642 S \* 7/2019 Shinkle ..... D22/104  
D857,142 S \* 8/2019 Seville ..... D22/104  
D868,923 S \* 12/2019 Toner ..... D22/104  
10,724,814 B2 \* 7/2020 Thomele ..... F41A 11/00  
D894,310 S \* 8/2020 Spine ..... D22/104  
D903,807 S \* 12/2020 Delgado Acarreta ..... D22/108  
D910,796 S \* 2/2021 Jen ..... D22/108  
(Continued)

**OTHER PUBLICATIONS**

Castiglione, Alexander. “Shadow System Releases New Compact Multi-Role Pistol—The MR920” Posted: Jan. 20, 2020 [visited: Dec. 27, 2021] Recoil URL: <https://www.recoilweb.com/shadow-system-releases-new-compact-multi-role-pistol-the-mr920-156693.html> (Year: 2020).\*

(Continued)

*Primary Examiner* — Michael A. Pratt  
(74) *Attorney, Agent, or Firm* — Kim IP Law Group LLC

(57) **CLAIM**

The ornamental design for a slide for a firearm, as shown and described.

**DESCRIPTION**

FIG. 1 is a top perspective view of a slide for a firearm in accordance with the new design;  
FIG. 2 is a left-side view of the slide for a firearm of FIG. 1;  
FIG. 3 is a right-side view of the slide for a firearm of FIG. 1;  
FIG. 4 is a front view of the slide for a firearm of FIG. 1;  
FIG. 5 is a rear view of the slide for a firearm of FIG. 1; and,  
FIG. 6 is a top view of the slide for a firearm of FIG. 1.  
The broken lines in the figures are directed to portions of a firearm that form no part of the claim. The shaded surfaces in the figures form part of the claim.

**1 Claim, 6 Drawing Sheets**

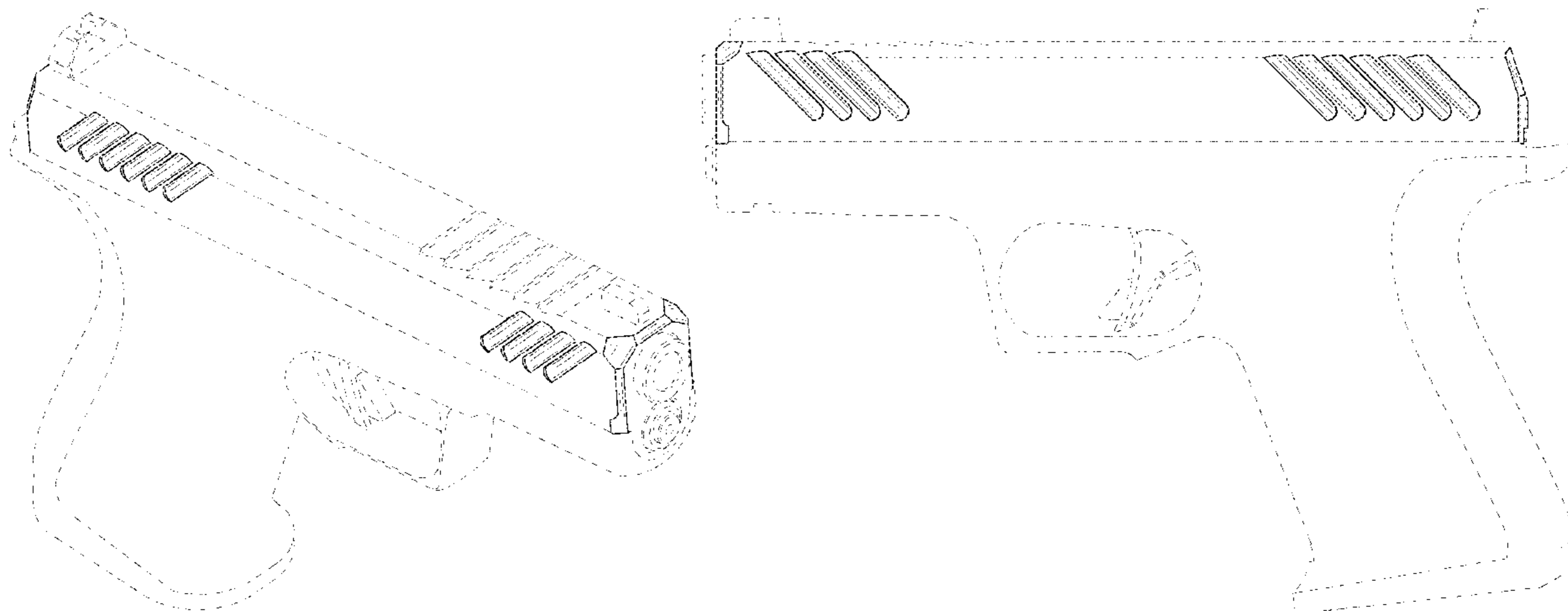

(56)

**References Cited**

U.S. PATENT DOCUMENTS

11,067,348 B1 \* 7/2021 Ribic ..... F41G 1/30  
D933,772 S \* 10/2021 Sroufe ..... D22/104  
2014/0165442 A1 \* 6/2014 Nebeker ..... F41A 3/64  
42/16  
2021/0293500 A1 \* 9/2021 Ribic ..... F41G 1/30

OTHER PUBLICATIONS

Cox, Matthew. "A Truly Shootable Tactical Pistol: Shadow Systems Shows Off Its New Take." Posted: Jan. 22, 2020 [visited: Dec. 27, 2021] Military.com URL: <https://www.military.com/daily-news/2020/01/22/truly-shootable-tactical-pistol-shadow-systems-shows-its-new-take.html> (Year: 2020).\*

Billings, Jacki. "Shadow Systems Releases New MR920 Pistol" Posted: Jan. 28, 2020 [visited: Dec. 20, 2021] Guns URL: <https://www.guns.com/news/2020/01/28/shadow-systems-releases-new-mr920-pistol> (Year: 2020).\*

GLD1980. "Shadow Systems MR920" Posted: Feb. 12, 2020 [visited: Dec. 27, 2021] Glock Talk URL: <https://www.glocktalk.com/threads/shadow-systems-mr920.1810698/> (Year: 2020).\*

\* cited by examiner

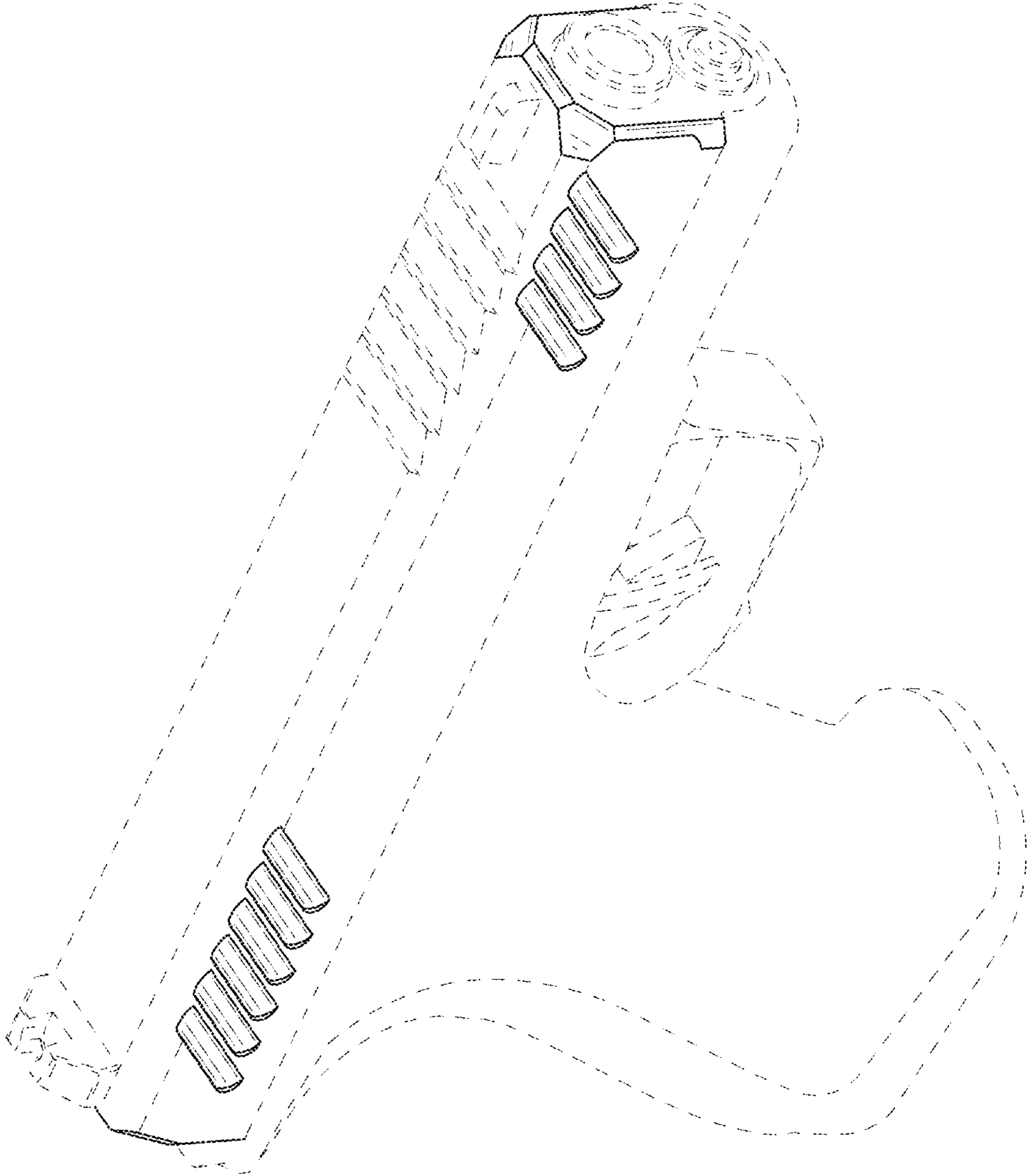

FIG. 1

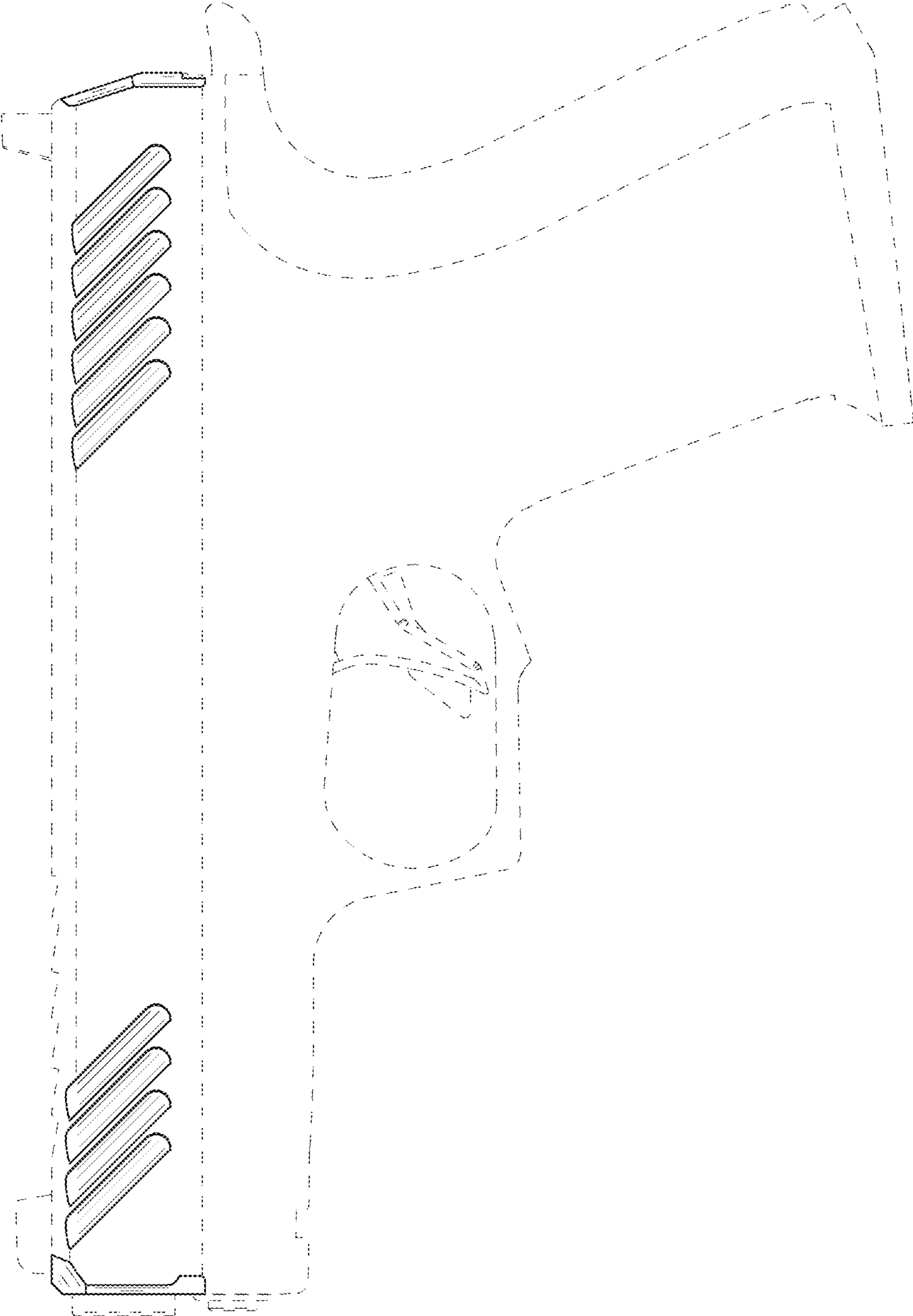

FIG. 2

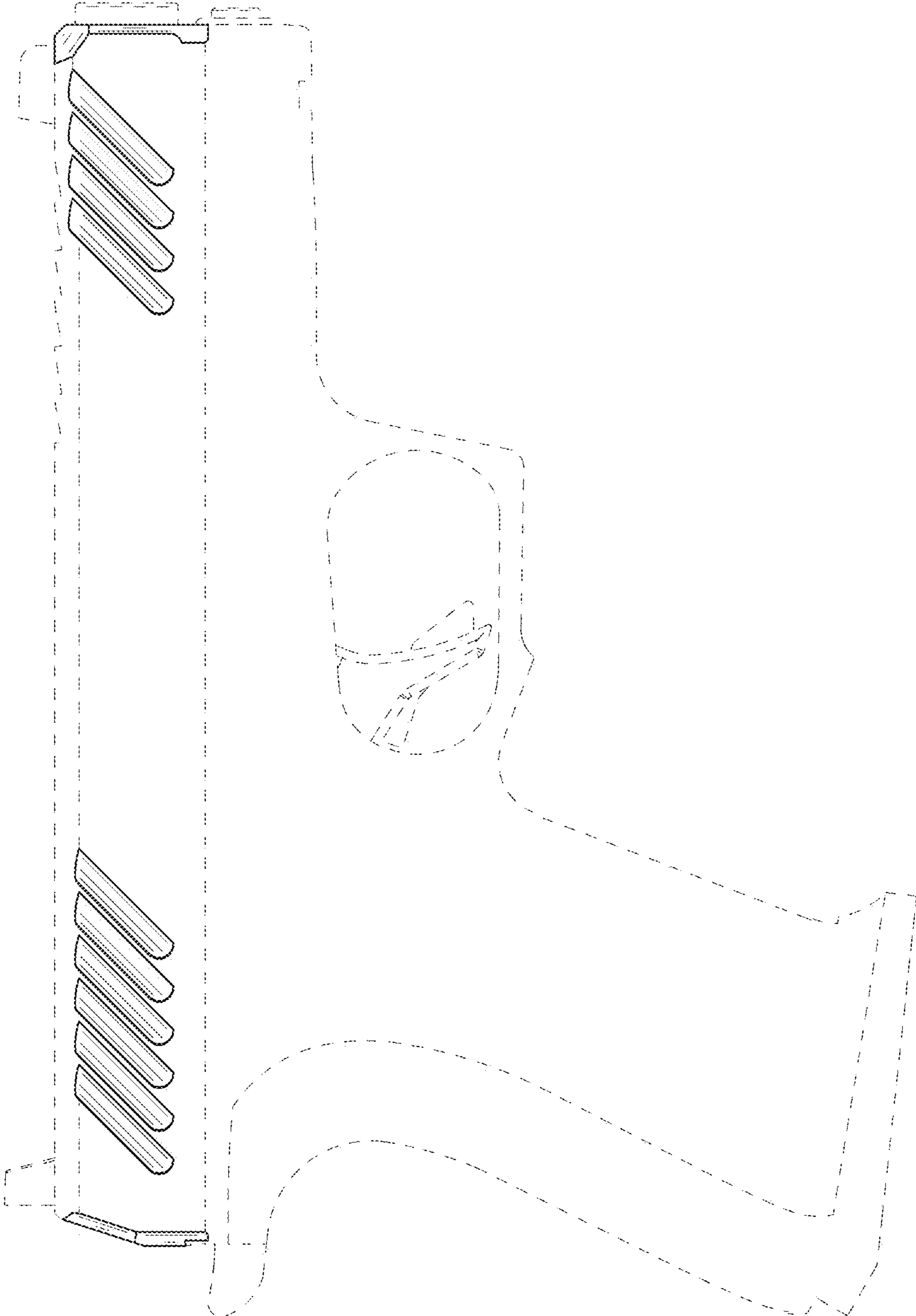

FIG. 3



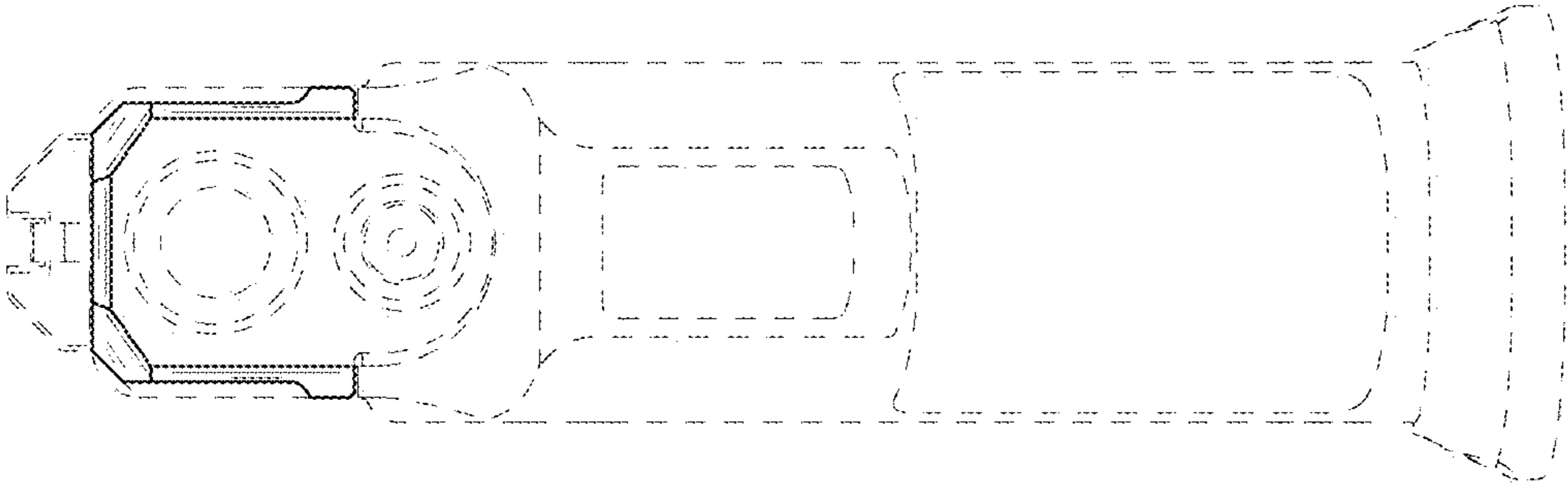

FIG. 4

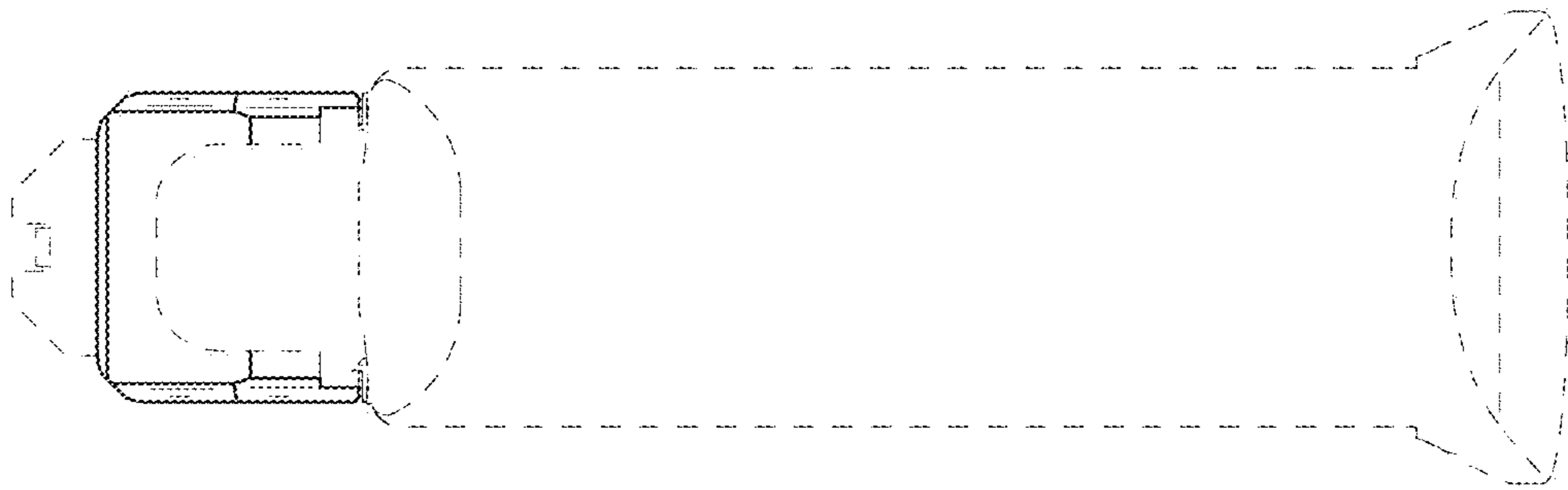

FIG. 5

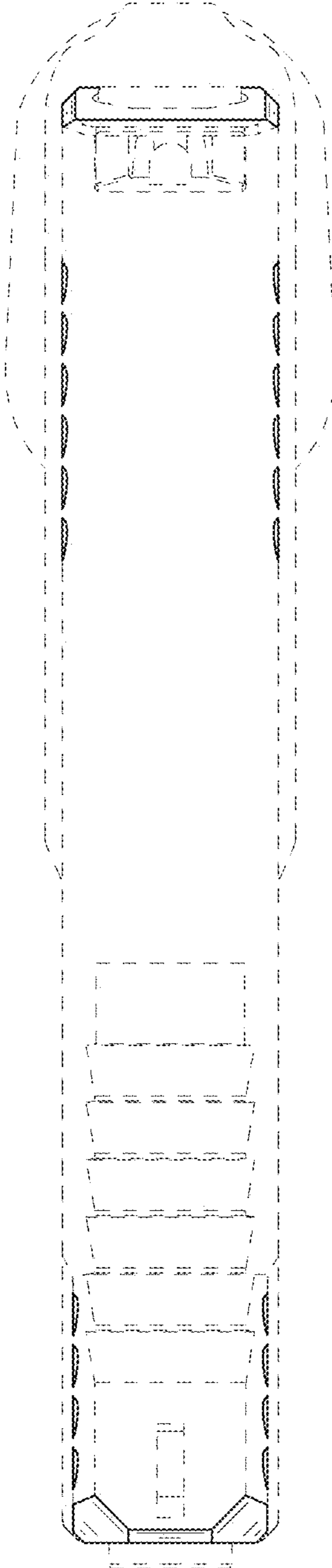

FIG. 6