



US00D965722S

(12) **United States Design Patent** (10) **Patent No.:** **US D965,722 S**
Wen (45) **Date of Patent:** **** Oct. 4, 2022**

(54) **INFLATABLE TOY**
(71) Applicant: **Yajie Wen**, Shenzhen (CN)
(72) Inventor: **Yajie Wen**, Shenzhen (CN)
(**) Term: **15 Years**
(21) Appl. No.: **29/828,240**
(22) Filed: **Feb. 25, 2022**
(51) **LOC (13) Cl.** **21-01**
(52) **U.S. Cl.**
USPC **D21/803**; D6/596
(58) **Field of Classification Search**
USPC D21/803, 804, 807–810; D6/596;
D29/124
CPC A47C 15/006; A47C 15/008
See application file for complete search history.

D840,485 S * 2/2019 Bosacco B63C 9/08
D29/124
D858,674 S 9/2019 Shu
D861,102 S * 9/2019 Sharpe D21/803
D869,589 S * 12/2019 Castro D21/803
D888,177 S * 6/2020 Peterson D21/803
D921,805 S * 6/2021 Katemann D21/803
D934,368 S * 10/2021 Peterson D21/803

* cited by examiner

Primary Examiner — Michael C Stout
Assistant Examiner — Melvin L Davis

(57) **CLAIM**

The ornamental design for an inflatable toy, as shown and described.

DESCRIPTION

FIG. 1 is a perspective view of an inflatable toy showing my new design;
FIG. 2 is another perspective view thereof;
FIG. 3 is a front elevational view thereof;
FIG. 4 is a rear elevational view thereof;
FIG. 5 is a left side elevational view thereof;
FIG. 6 is a right side elevational view thereof;
FIG. 7 is a top plan view thereof;
FIG. 8 is a bottom plan view thereof; and,
FIG. 9 is an enlarged view of portion 9 shown in FIG. 2.
The dot-dash broken lines represent the boundary of the enlarged portion and form no part of the claimed design.

1 Claim, 9 Drawing Sheets

(56) **References Cited**
U.S. PATENT DOCUMENTS
D399,551 S * 10/1998 Peterson D21/803
D559,934 S * 1/2008 Brown D21/803
D736,882 S * 8/2015 Chen D21/803
D798,620 S 10/2017 Liu
D806,196 S * 12/2017 Hoffmann A47C 7/624
D21/803
D820,374 S * 6/2018 Rademacher D21/814
D825,702 S * 8/2018 Glick D21/803
D832,384 S * 10/2018 Frank D21/803
D834,672 S * 11/2018 Hachigian D21/803

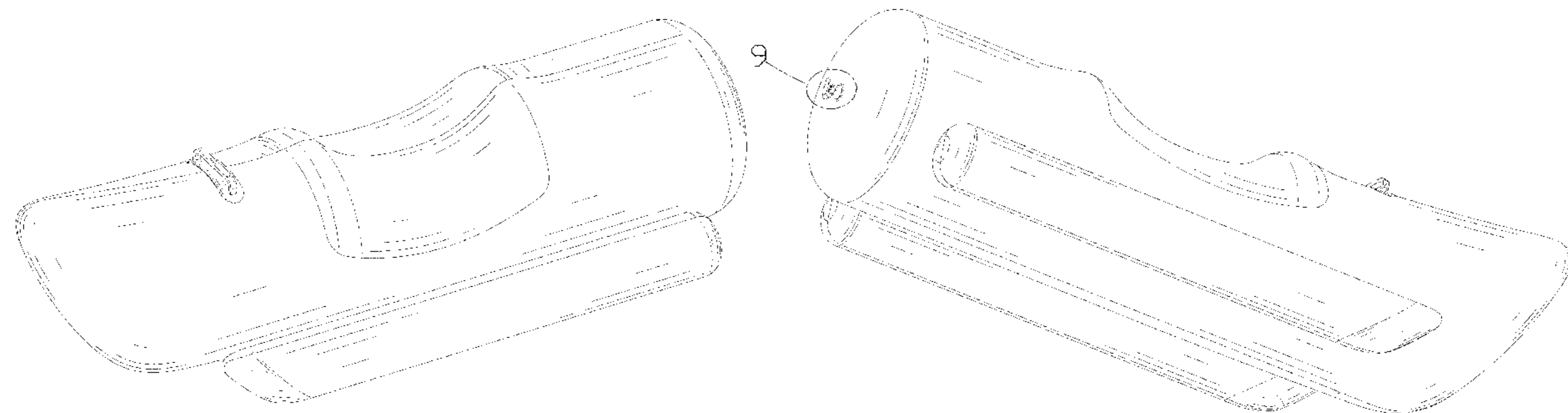

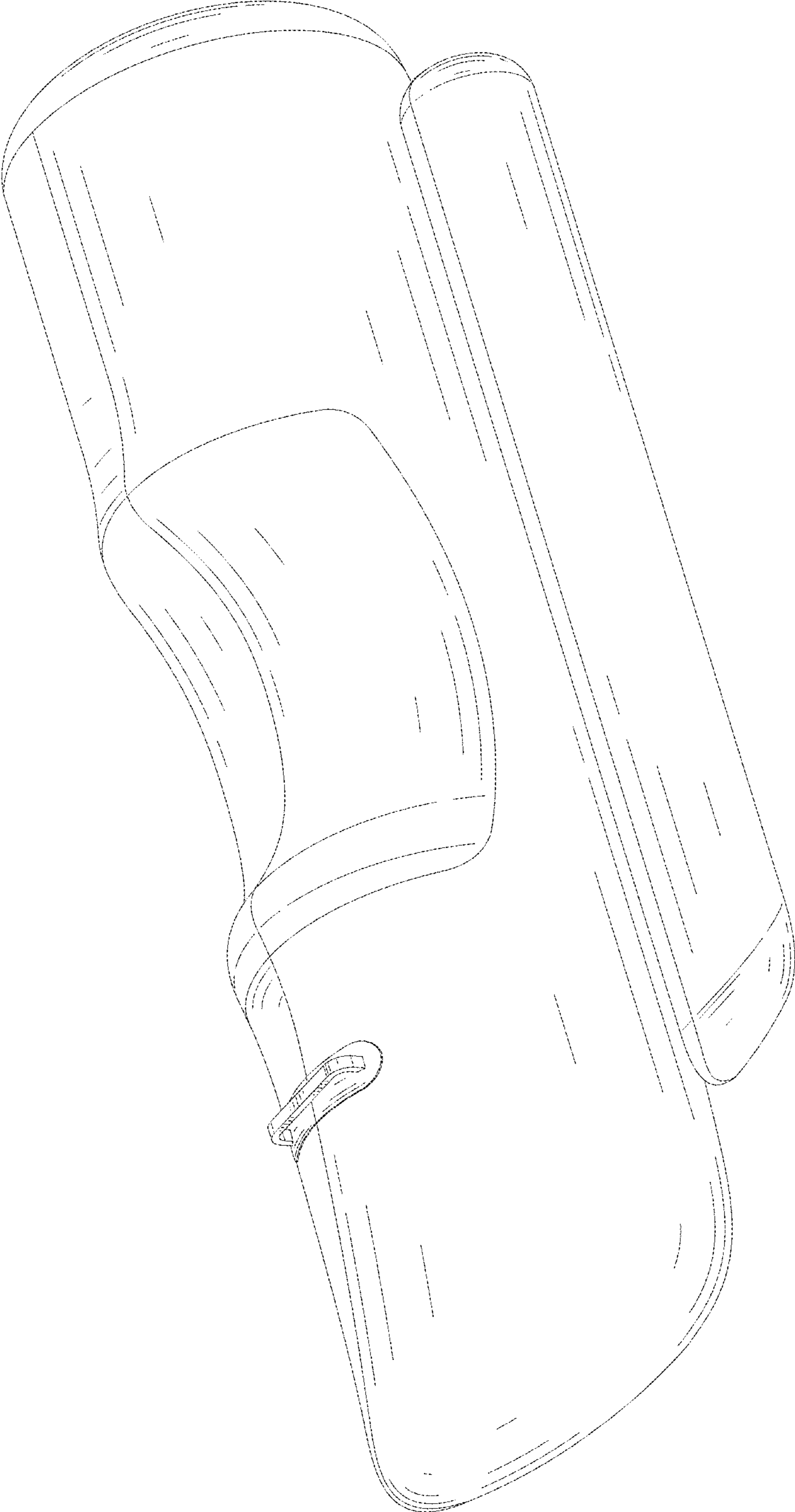

FIG. 1

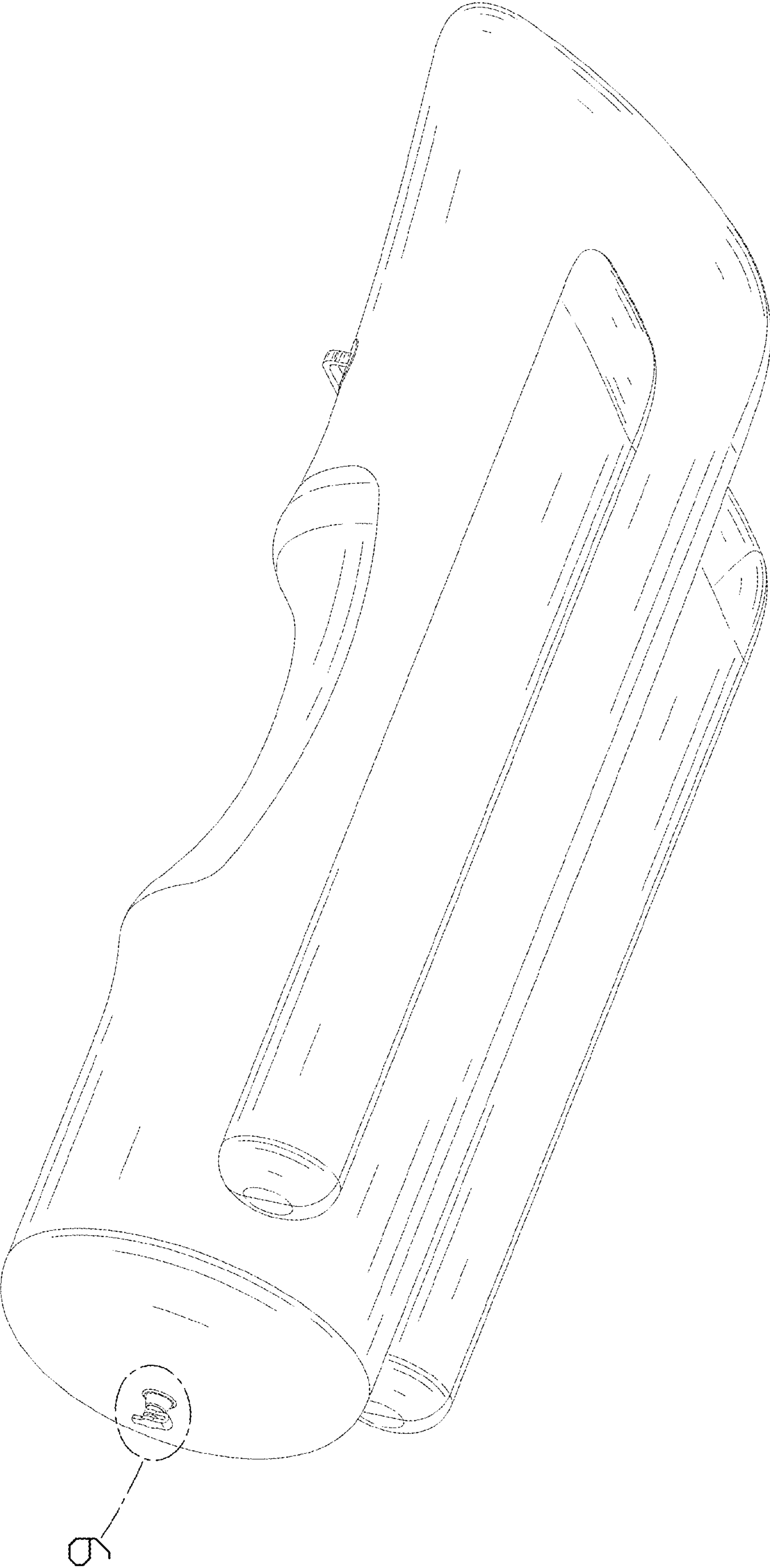

FIG. 2

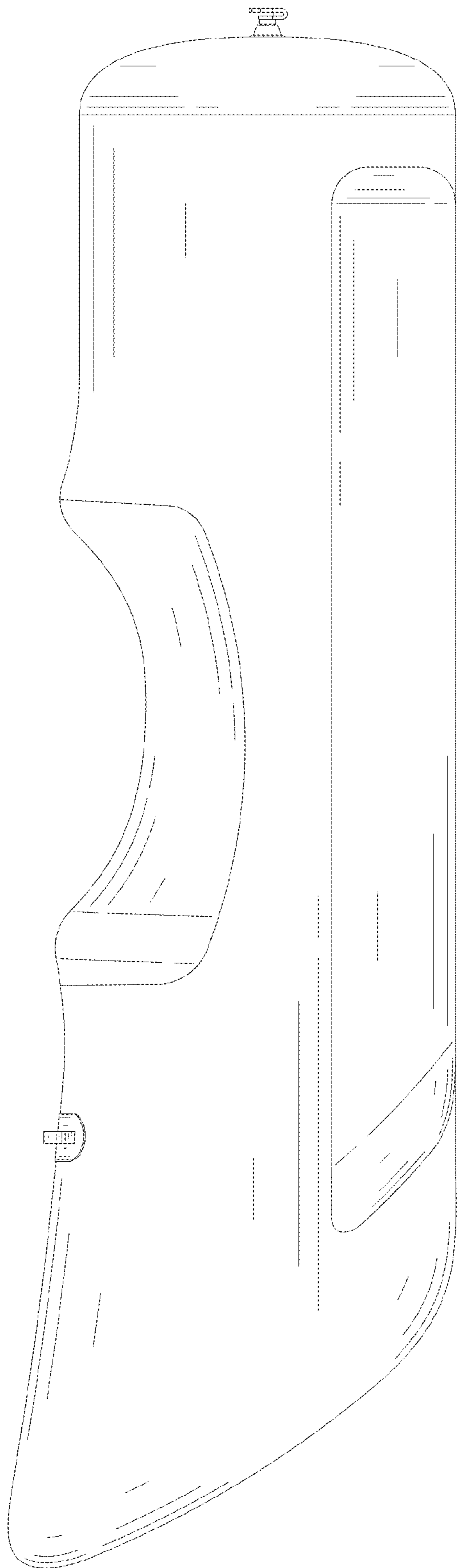

FIG. 3

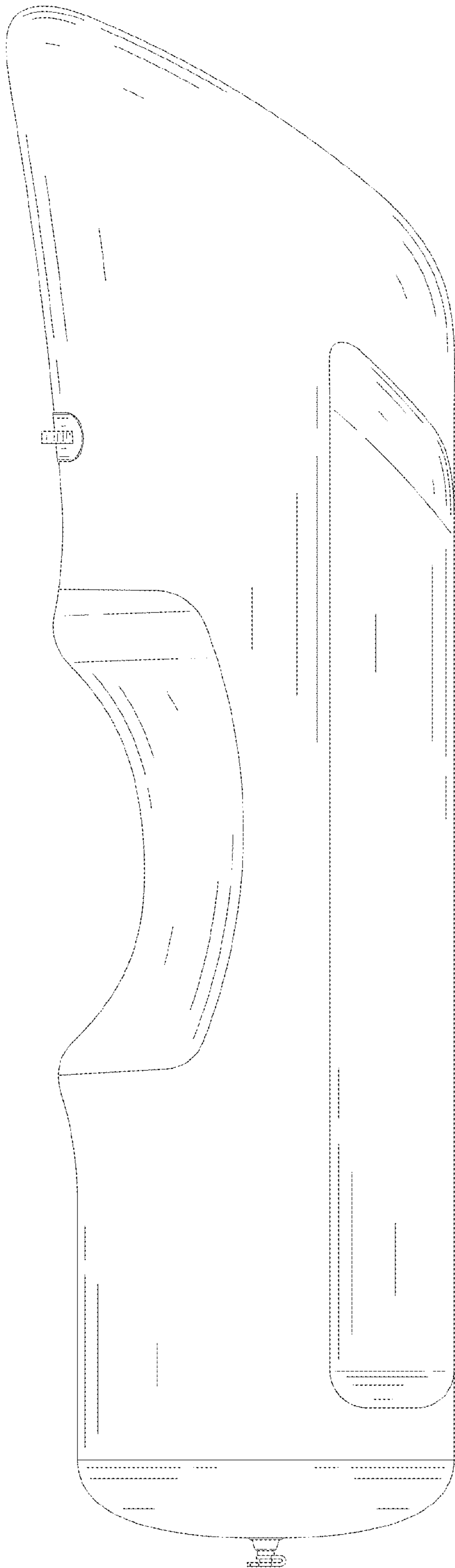

FIG. 4

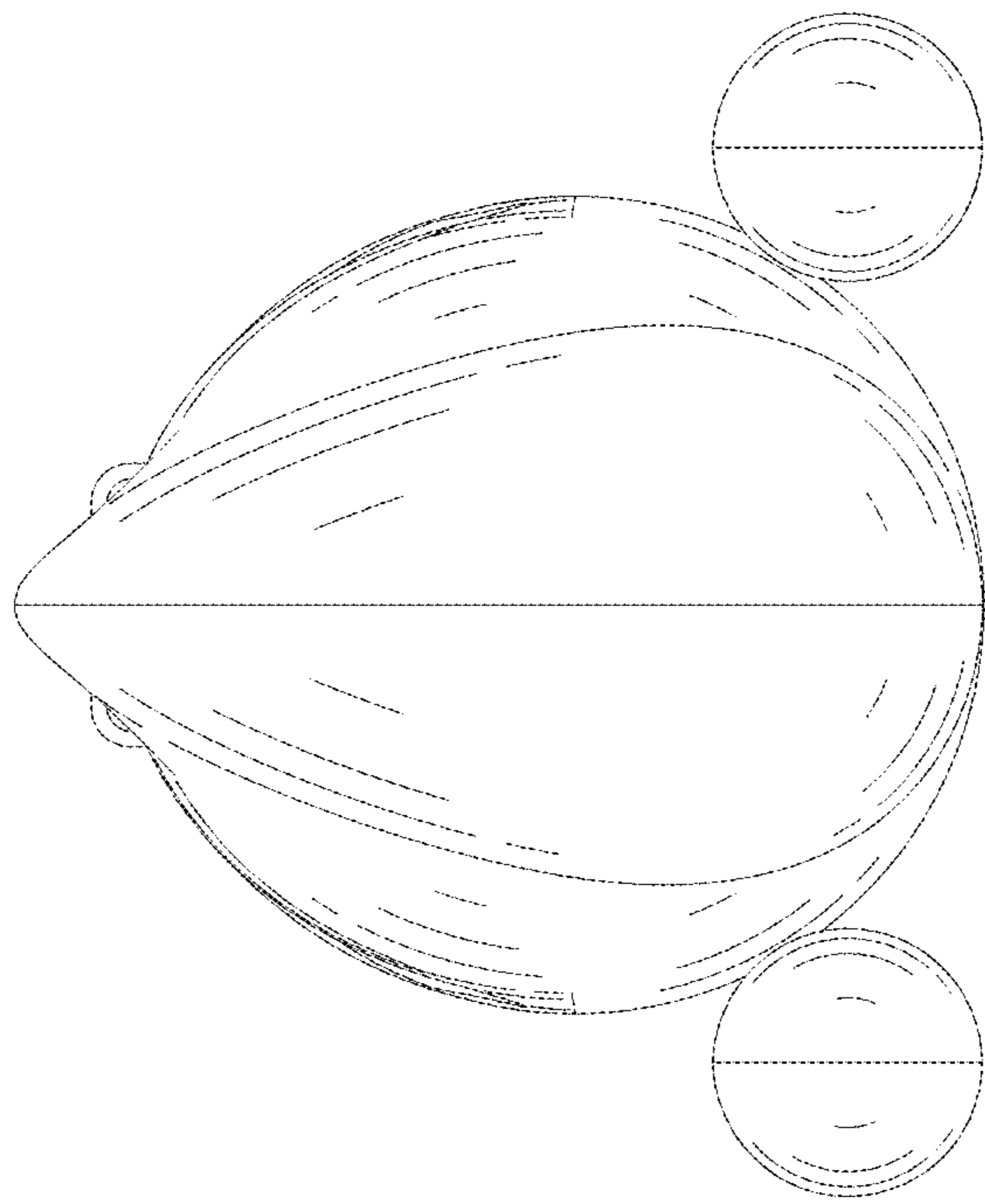

FIG. 5

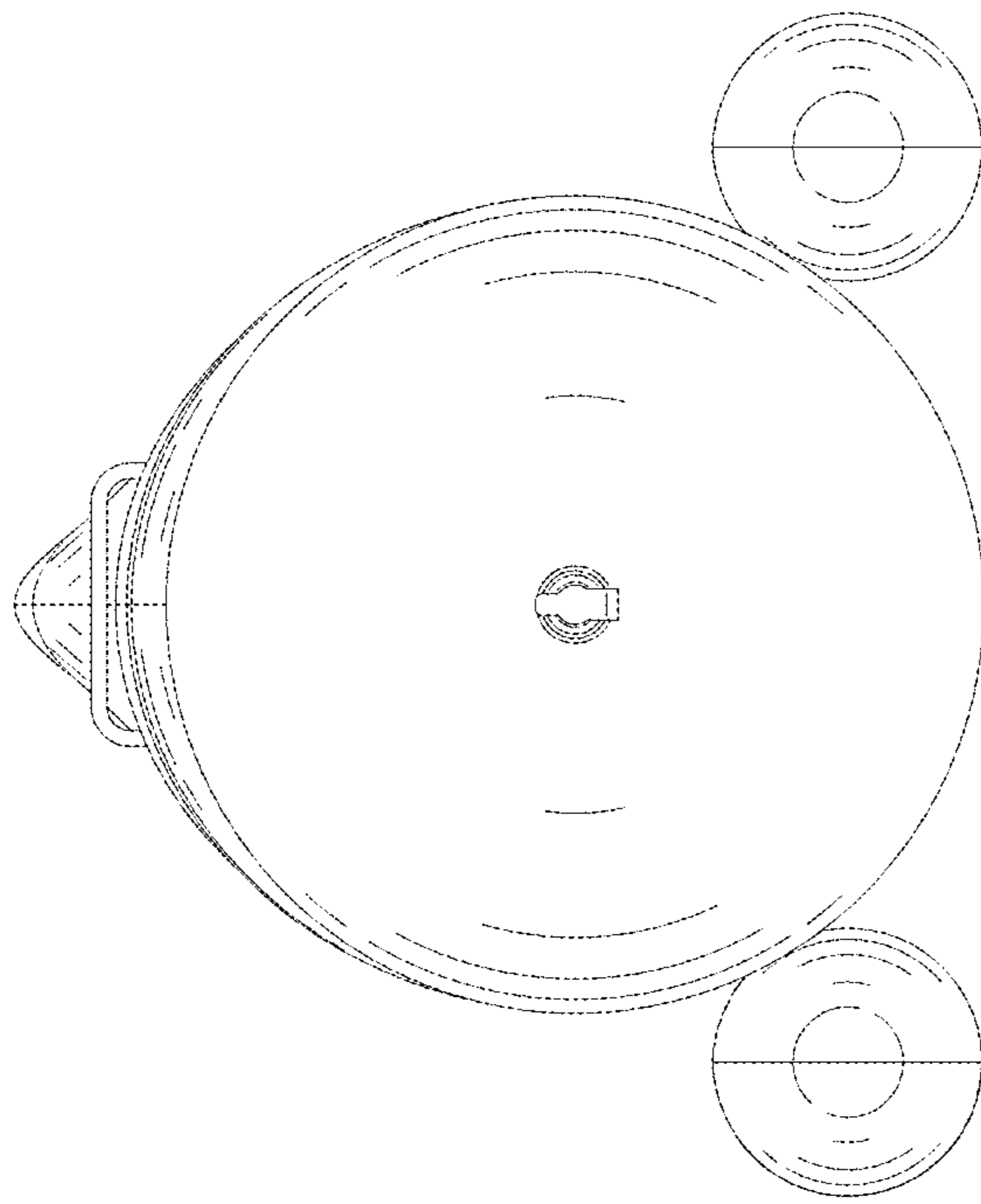

FIG. 6

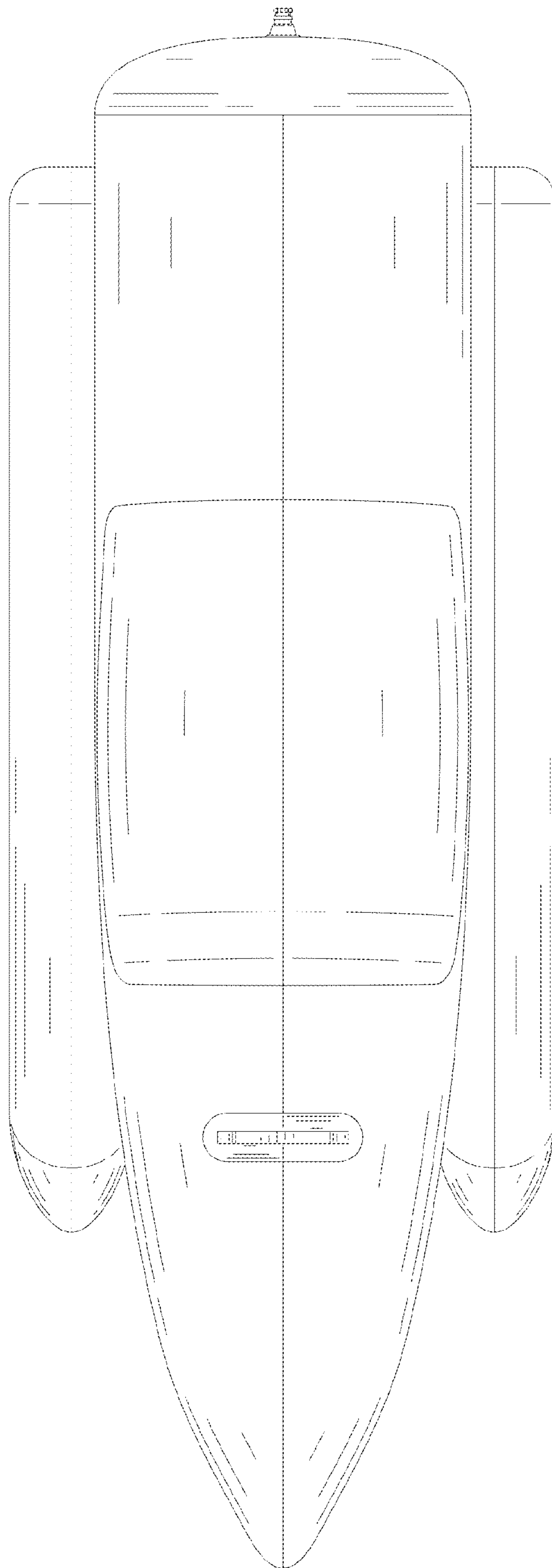

FIG. 7

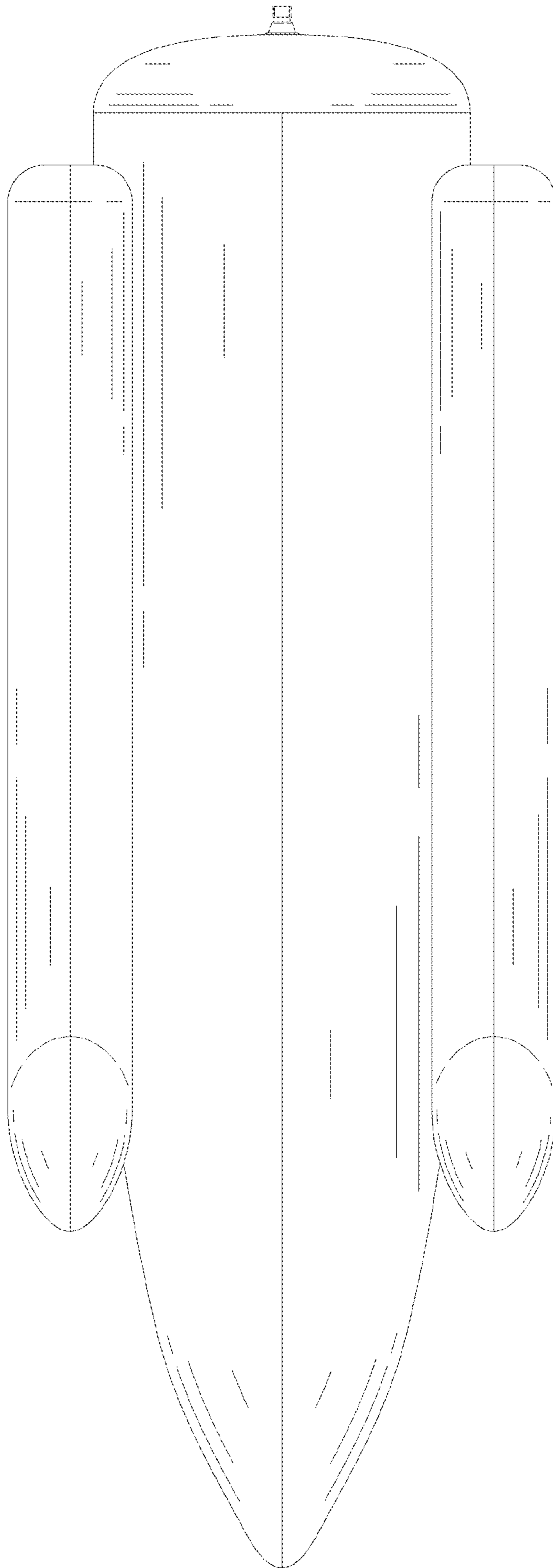

FIG. 8

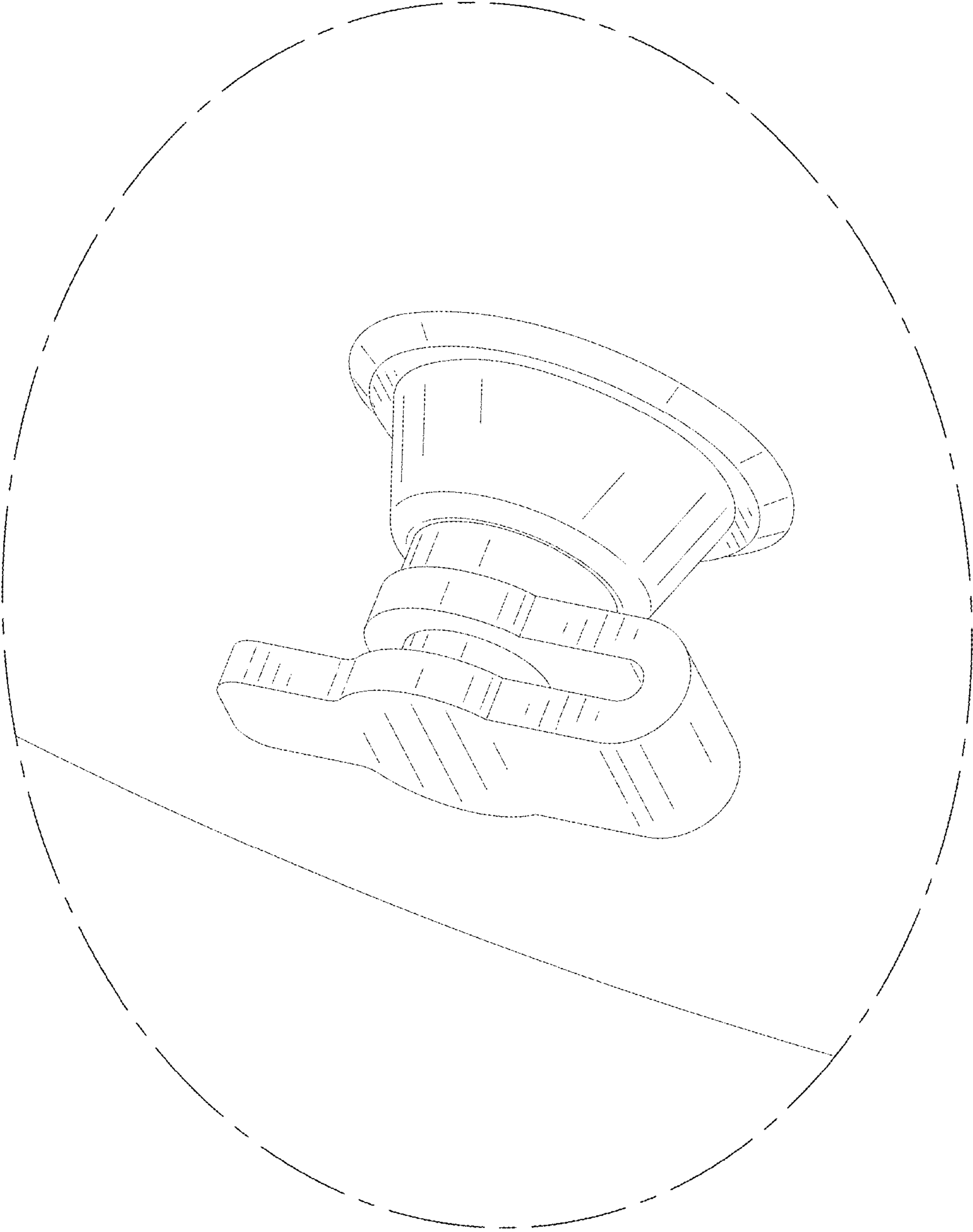

FIG. 9