



US00D965681S

(12) **United States Design Patent**
Yao

(10) **Patent No.:** **US D965,681 S**

(45) **Date of Patent:** **** Oct. 4, 2022**

(54) **MAIL SORTER**

(71) Applicant: **Yujin Yao**, Ganzhou (CN)

(72) Inventor: **Yujin Yao**, Ganzhou (CN)

(**) Term: **15 Years**

(21) Appl. No.: **29/806,935**

(22) Filed: **Sep. 8, 2021**

(51) **LOC (13) Cl.** **19-07**

(52) **U.S. Cl.**
USPC **D19/75**

(58) **Field of Classification Search**
USPC D19/92, 75-91, 99, 135; D3/206, 304,
D3/306, 310, 315; D6/675.5, 683, 683.1;
D7/631, 637-641; D9/427, 432, 611;
D14/253
CPC .. B43M 99/00; B43M 99/001; B43M 99/003;
B43M 99/006; B43M 99/007; B43M
99/008; B43M 99/009; B42D 3/12; B42D
3/16; B42D 3/18; B43K 23/001; B43K
23/002; A47B 55/00; A47B 63/00
See application file for complete search history.

(56) **References Cited**

U.S. PATENT DOCUMENTS

D276,734 S *	12/1984	Landstrom	D19/91
4,577,773 A *	3/1986	Bitel	B25H 3/02 206/561
D298,764 S *	11/1988	Herr	D19/92
D323,855 S *	2/1992	Evenson	D19/86
D330,047 S *	10/1992	Evenson	D19/78
D340,068 S *	10/1993	Chan	D19/86
D353,158 S *	12/1994	Evenson	D19/86
D385,922 S *	11/1997	Tisbo	D19/75
D397,151 S *	8/1998	Schultz	D19/86
D433,251 S *	11/2000	Blazevich	D6/629
D478,354 S *	8/2003	Chen	D19/75
D489,096 S *	4/2004	Chen	D19/75
D502,741 S *	3/2005	Bain	D19/86

D509,540 S	9/2005	DeBruyne	
D691,659 S	10/2013	Hu	
D716,870 S *	11/2014	Jungst D19/91
D720,166 S *	12/2014	Trindall D6/683.1
D865,867 S *	11/2019	Muri D10/65

(Continued)

FOREIGN PATENT DOCUMENTS

CN	304073862 S	3/2017
CN	306303529 S	1/2021
CN	306709009 *	7/2021

(Continued)

OTHER PUBLICATIONS

Bamboo Desk File Mail Organizer posted by Stahala posted date Apr. 4, 2021, © Amazon, [online], [site visited Jul. 15, 2022]. Available from Internet, <https://www.amazon.com/Organizer-Countertop-Stahala-Documen-Envelope/> (Year: 2021).*

(Continued)

Primary Examiner — Garth Rademaker
Assistant Examiner — Laura H Yu

(57) **CLAIM**

The ornamental design for mail sorter, substantially as shown and described.

DESCRIPTION

FIG. 1 is a top, front, and right side perspective view of a mail sorter, showing my new design;
FIG. 2 is a right side elevational view thereof;
FIG. 3 is a left side elevational view thereof;
FIG. 4 is a front elevational view thereof;
FIG. 5 is a rear elevational view thereof;
FIG. 6 is a top plan view thereof;
FIG. 7 is a bottom plan view thereof; and,
FIG. 8 is an exploded view thereof.

1 Claim, 8 Drawing Sheets

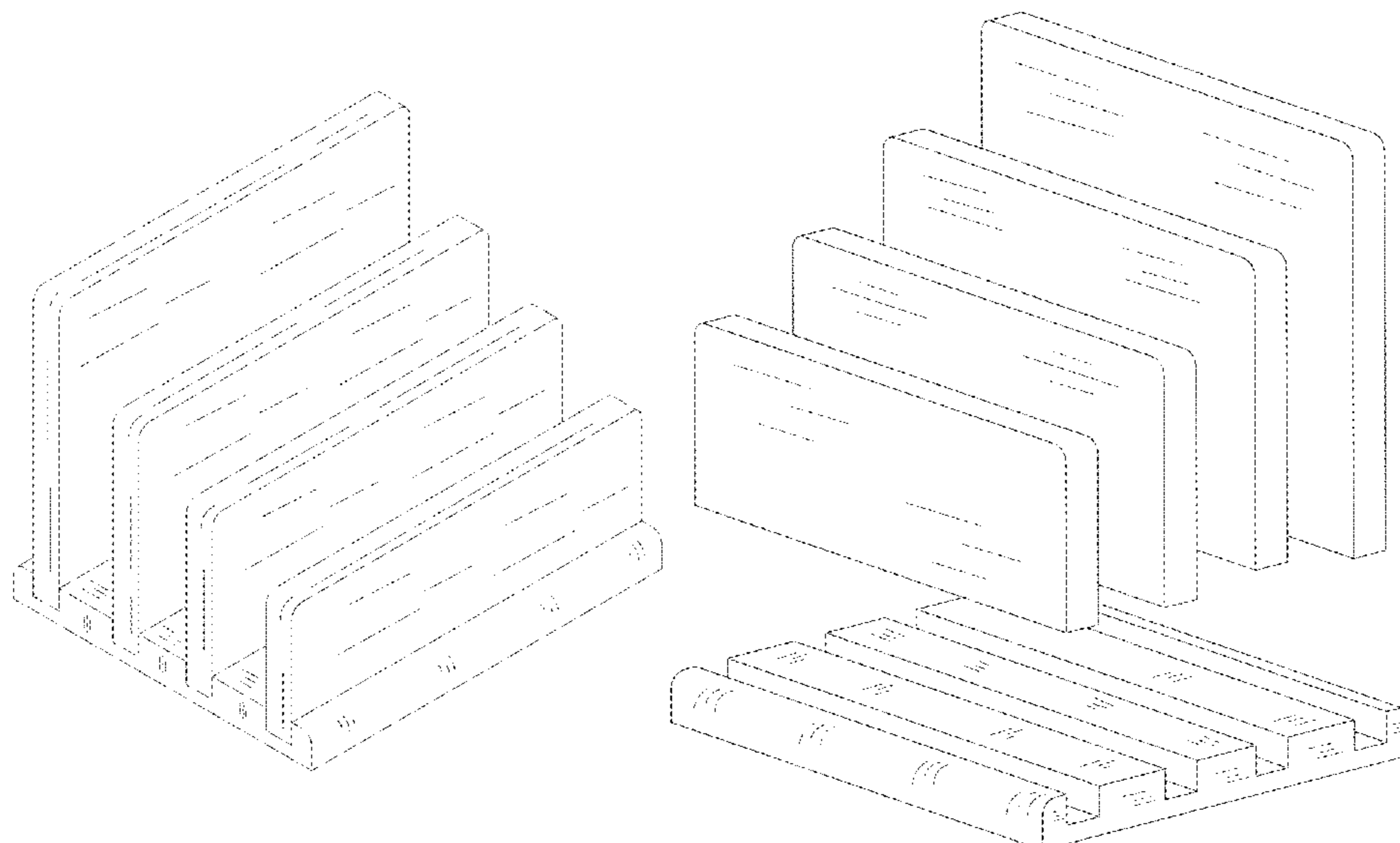

(56)

References Cited

U.S. PATENT DOCUMENTS

D898,116 S * 10/2020 Snell D19/90

FOREIGN PATENT DOCUMENTS

CN 306735343 * 8/2021
CN 306828681 * 9/2021

OTHER PUBLICATIONS

Bamboo Mail Organizer posted by Tand L Fashions posted date unknown, © Etsy, [online], [site visited Jul. 15, 2022]. Available from Internet, <https://www.etsy.com/listing/1222709437/bamboo-mail-organizer-with-rubber-feets> (Year: 2022).*

Bamboo Mail Organizer posted by WISHACC posted review date Nov. 1, 2021, © UBUY, [online], [site visited Jul. 15, 2022]. Available from Internet, <https://www.u-buy.jp/en/product/40SGCXPGG-bamboo-mail-organizer-wishacc> (Year: 2021).*

* cited by examiner

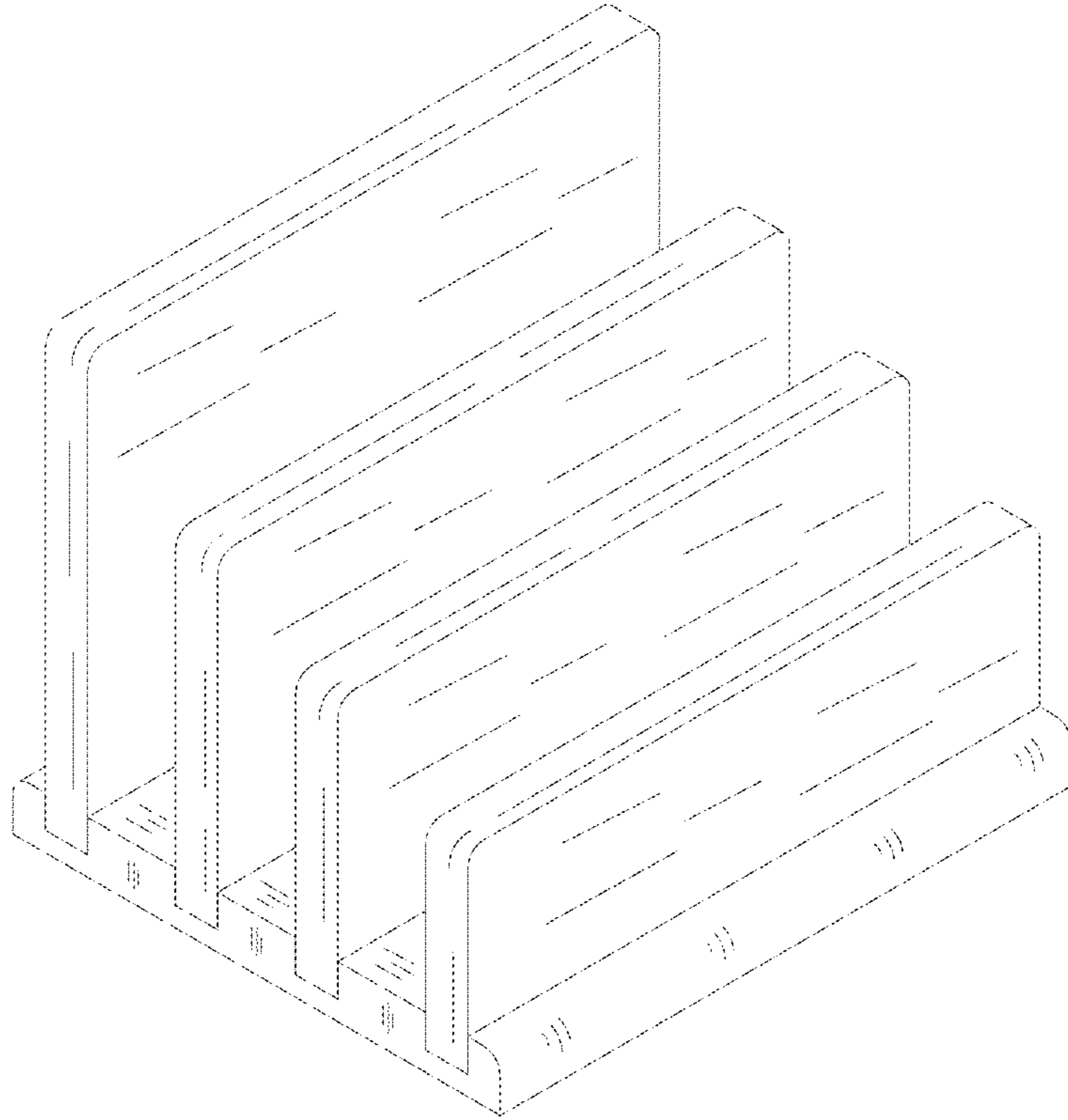

FIG. 1

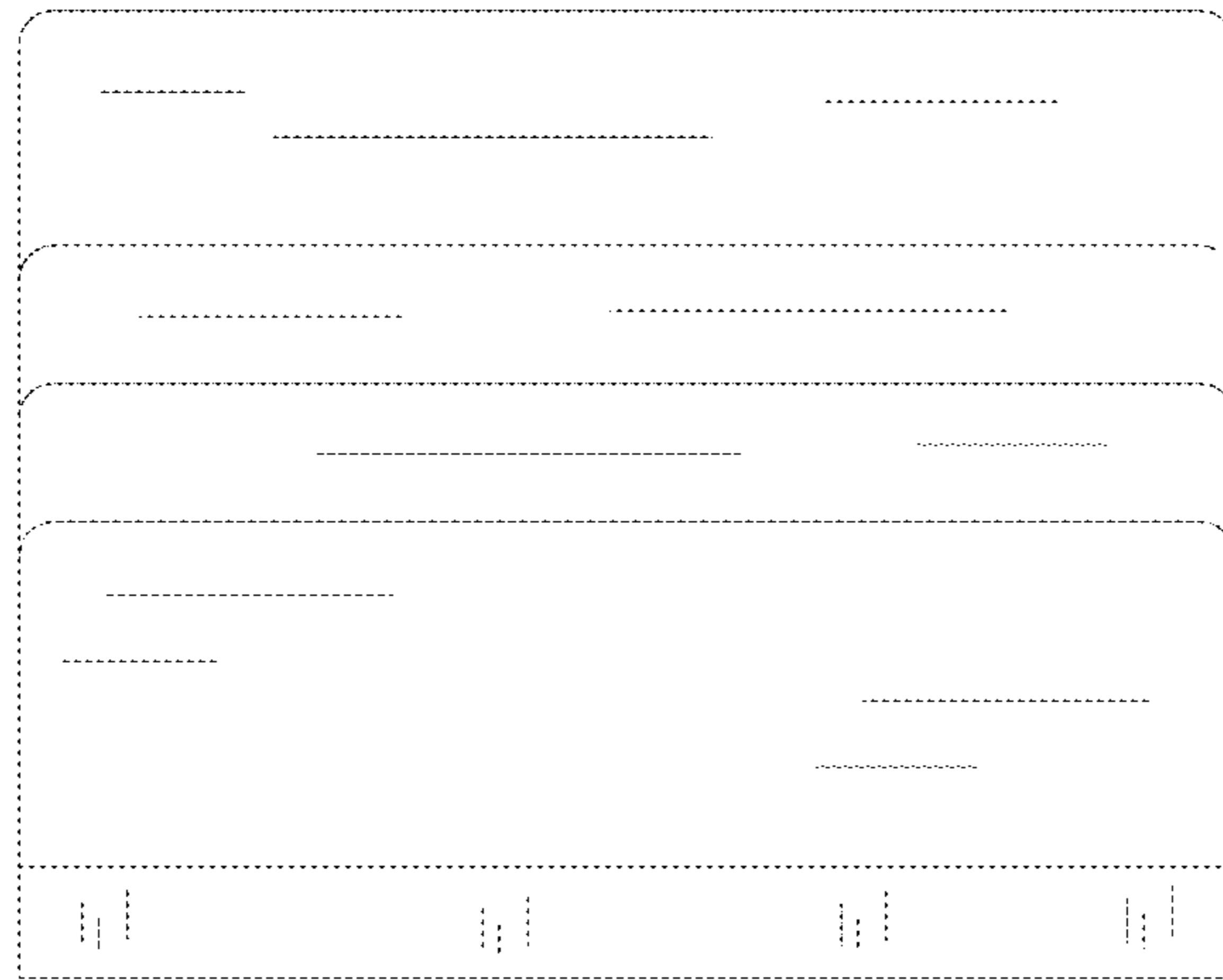

FIG. 2

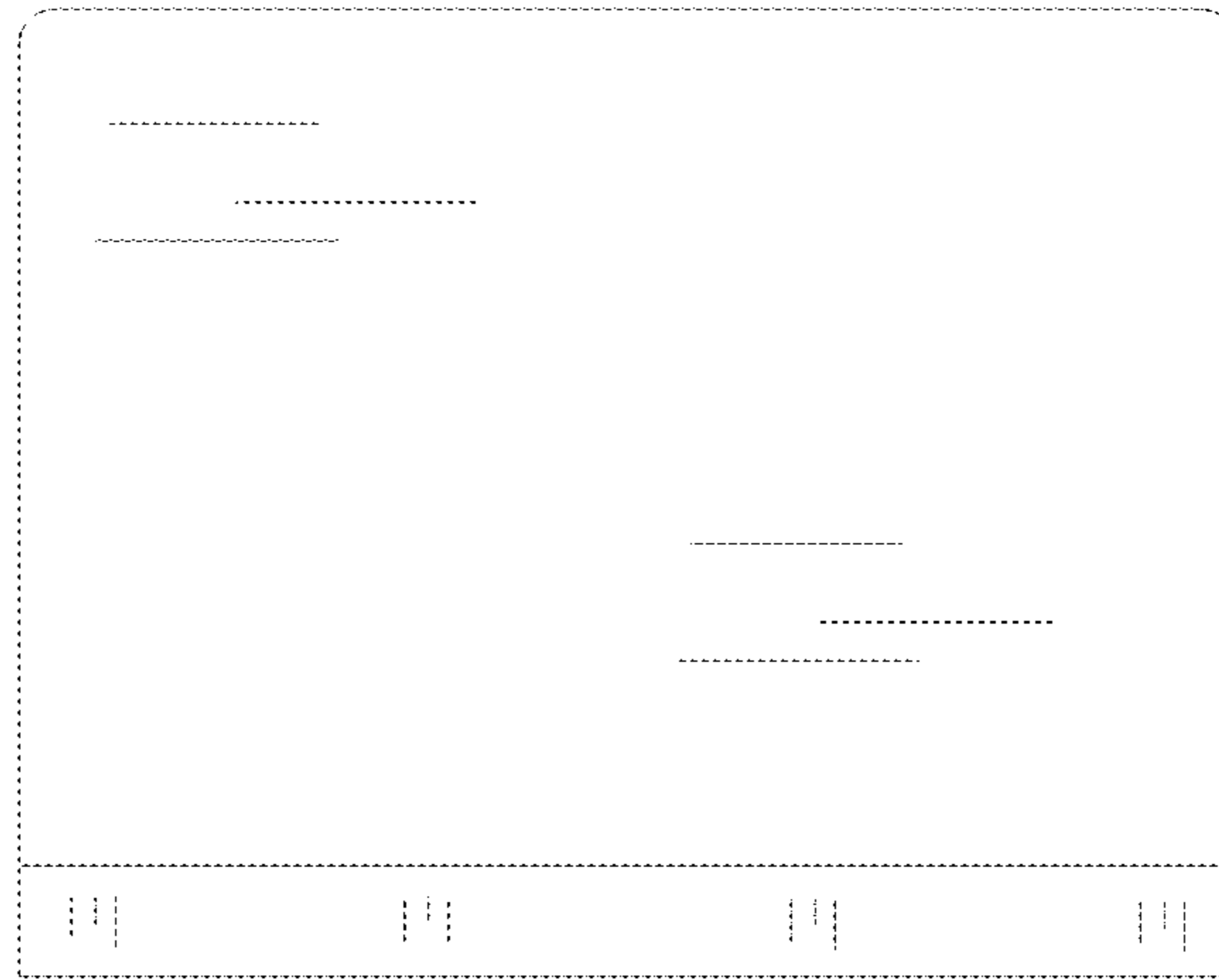

FIG. 3

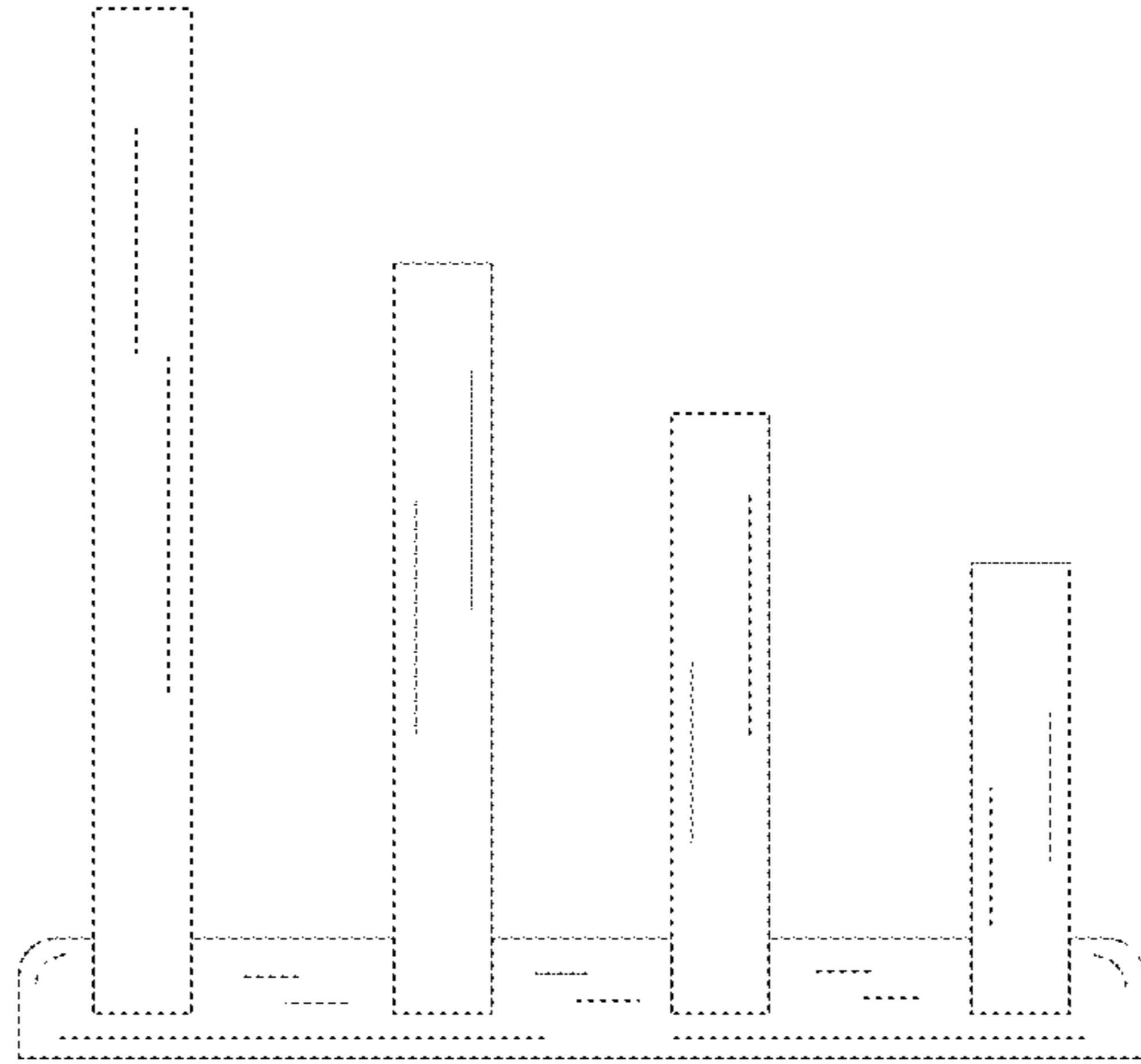

FIG. 4

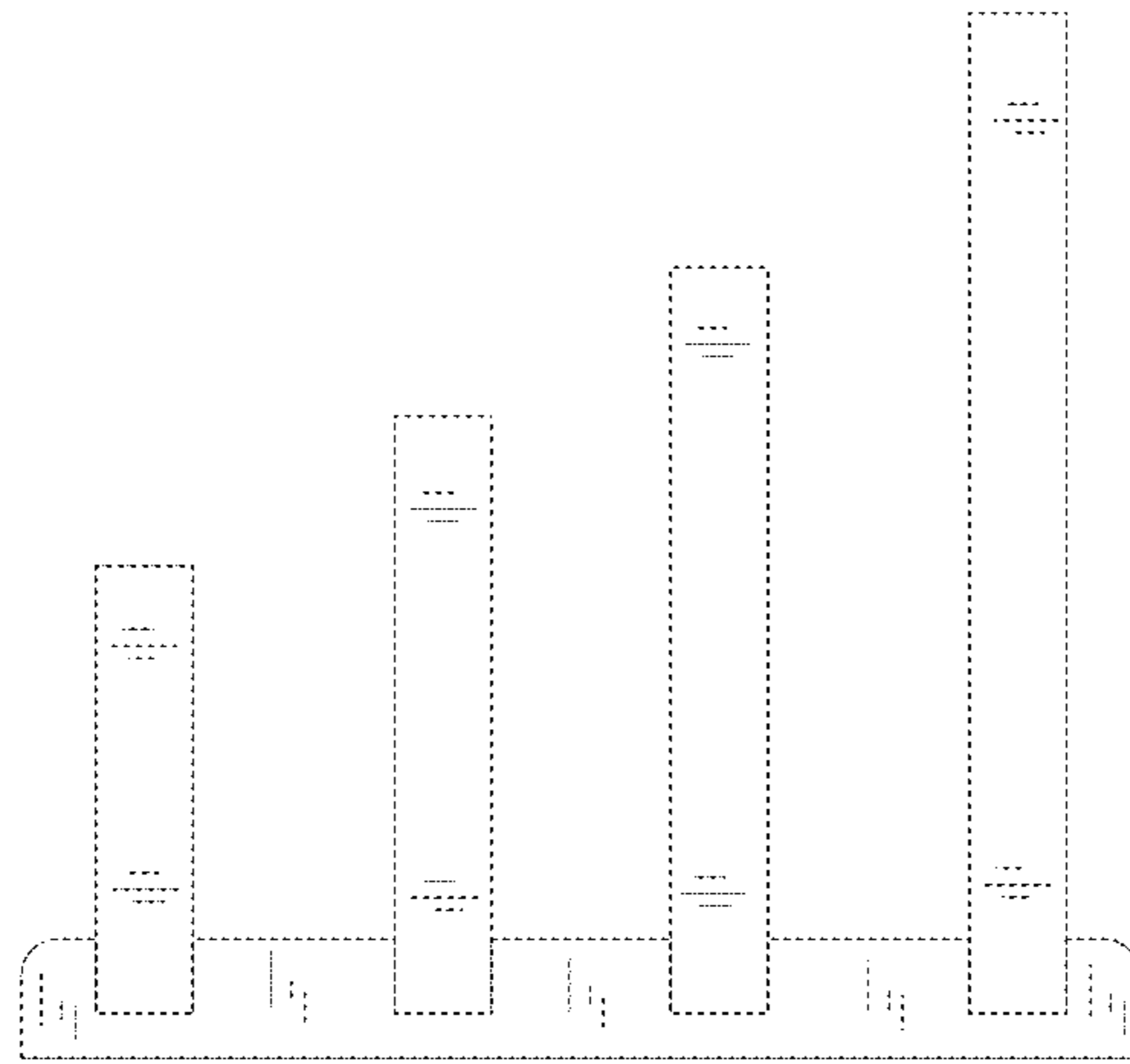

FIG. 5

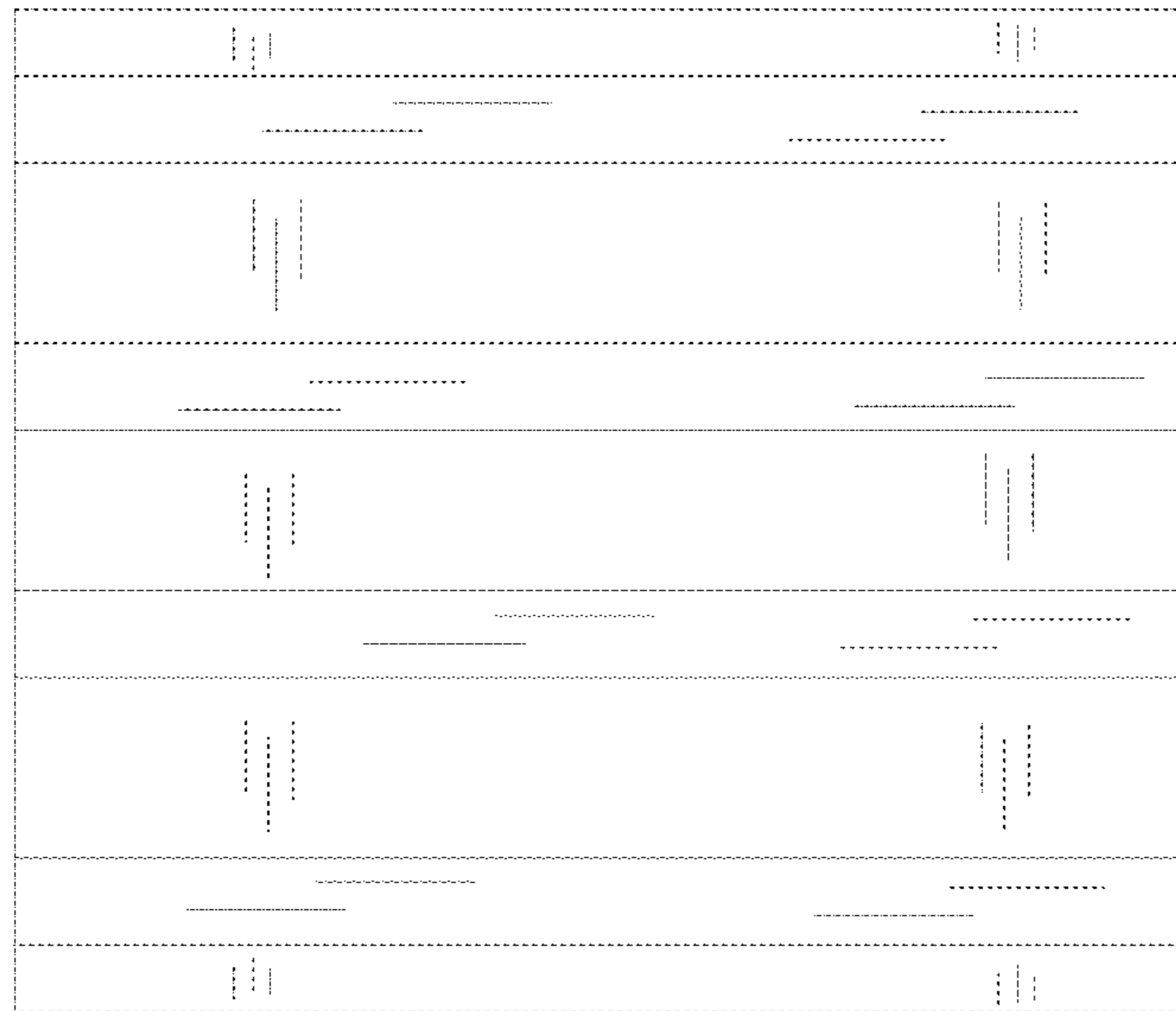

FIG. 6

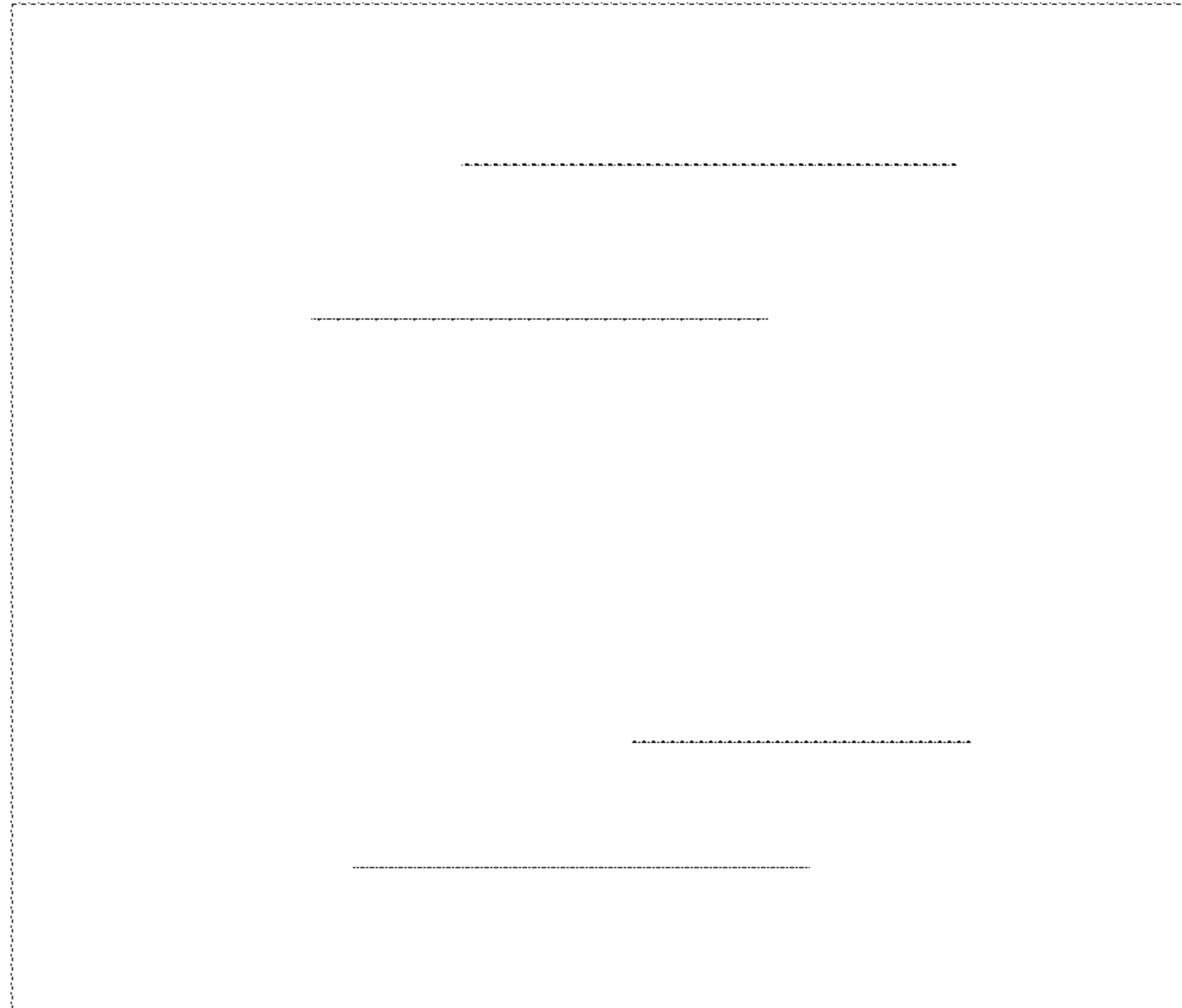

FIG. 7

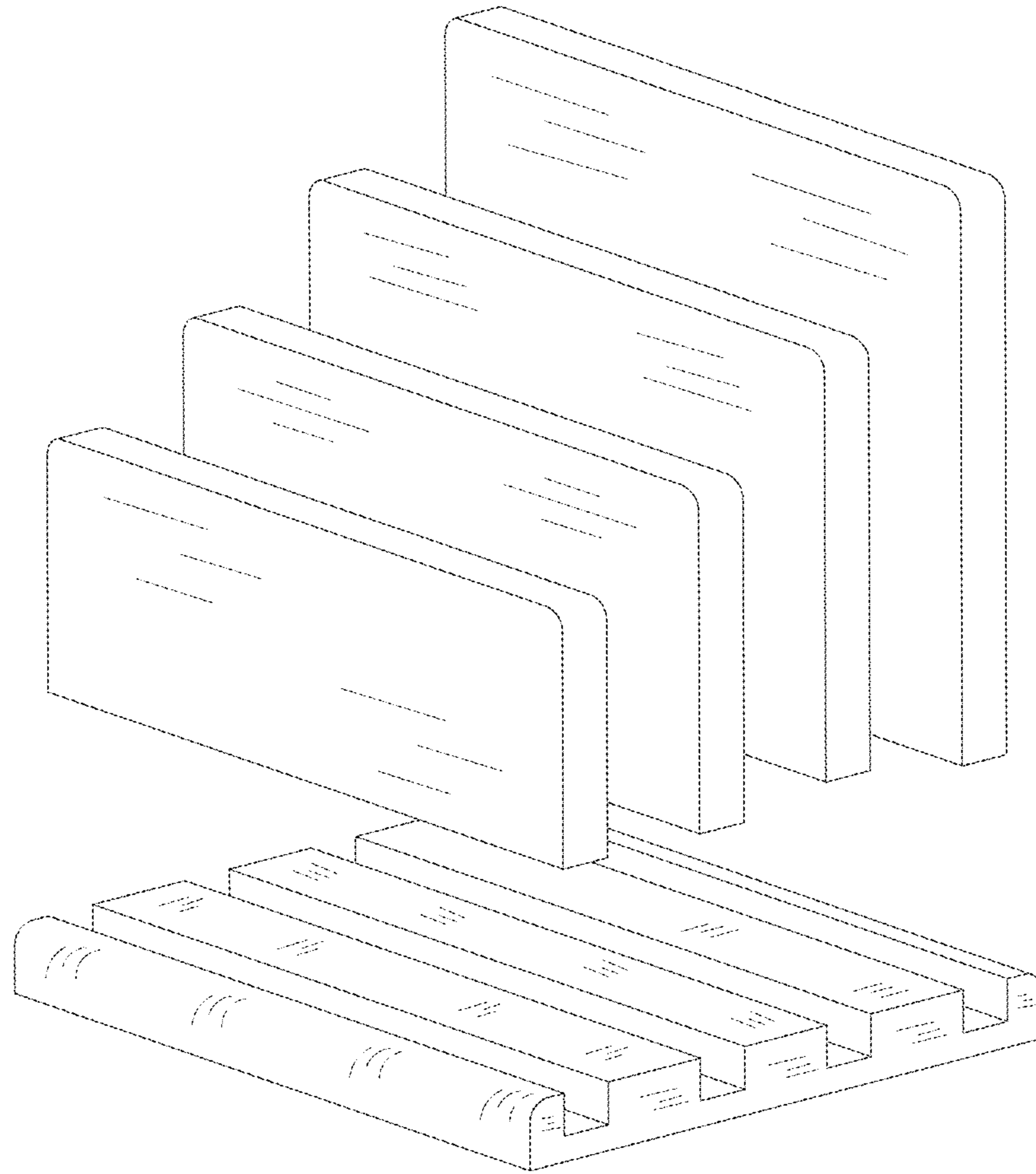

FIG. 8