



US00D965647S

(12) **United States Design Patent**
Yao

(10) **Patent No.:** **US D965,647 S**

(45) **Date of Patent:** **** Oct. 4, 2022**

- (54) **MINI MIRROR REFRIGERATOR**
- (71) Applicant: **Shenzhen Sanjutou Network Technology Co., Ltd., Shenzhen (CN)**
- (72) Inventor: **Zhihao Yao, Shenzhen (CN)**
- (**) Term: **15 Years**
- (21) Appl. No.: **29/822,452**
- (22) Filed: **Jan. 10, 2022**
- (51) **LOC (13) Cl.** **15-07**
- (52) **U.S. Cl.**
USPC **D15/81**
- (58) **Field of Classification Search**
USPC D15/79-91
CPC F25D 17/065; F25D 2317/061; F25D 2323/023; F25D 23/028; F25D 23/126; F25D 11/02; F25D 2201/126; F25D 2201/1262; F25D 2201/14; F25D 2323/021; F25D 23/02; F25D 23/025; F25D 23/04; F25D 23/062; F25D 23/064; F25D 23/065; F25D 23/067; F25D 2400/361; F25D 25/025; F25D 25/04; F25D 29/005; F25D 29/006; F25D 31/005; F25D 3/06
See application file for complete search history.

D896,856 S *	9/2020	Zhou	D15/81
D898,083 S *	10/2020	Yao	D15/79
D905,129 S *	12/2020	Deng	D15/81
D919,678 S *	5/2021	Yang	D15/81
D924,946 S *	7/2021	Xu	D15/81
D927,562 S	8/2021	Kong	
D930,716 S	9/2021	Huang	
D937,910 S	12/2021	Huang	
D940,209 S	1/2022	Kong	
D944,300 S *	2/2022	Zhu	D15/88
D946,636 S *	3/2022	Xu	D15/81
D947,905 S *	4/2022	Xu	D15/81
D950,612 S *	5/2022	Choi	D15/79
D957,478 S *	7/2022	Choi	D15/79
D958,850 S *	7/2022	Kim	D15/88

* cited by examiner

Primary Examiner — Khawaja Anwar

(74) *Attorney, Agent, or Firm* — Rumit Ranjit Kanakia

(57) **CLAIM**

The ornamental design for a mini mirror refrigerator, as shown and described.

DESCRIPTION

FIG. 1 is a perspective view of a mini mirror refrigerator showing my new design;
 FIG. 2 is another perspective view thereof;
 FIG. 3 is a front view thereof;
 FIG. 4 is a rear view thereof;
 FIG. 5 is a left side view thereof;
 FIG. 6 is a right side view thereof;
 FIG. 7 is a top view thereof;
 FIG. 8 is a bottom view thereof; and,
 FIG. 9 is a perspective view of the mini mirror refrigerator in an open state.
 The broken lines in the figures are for the purposes of illustrating portions of the mini mirror refrigerator, which form no part of the claimed design.

1 Claim, 9 Drawing Sheets

(56) **References Cited**

U.S. PATENT DOCUMENTS

D491,585 S	6/2004	Schmidt	
D502,471 S	3/2005	Yuen	
D508,503 S	8/2005	Schmidt	
D639,316 S	6/2011	Roberson	
D654,098 S	2/2012	Piffl	
D752,660 S	3/2016	Chen	
D826,291 S *	8/2018	Lim	D15/81
D826,996 S *	8/2018	Feng	D15/91
D886,163 S *	6/2020	Yao	D15/81

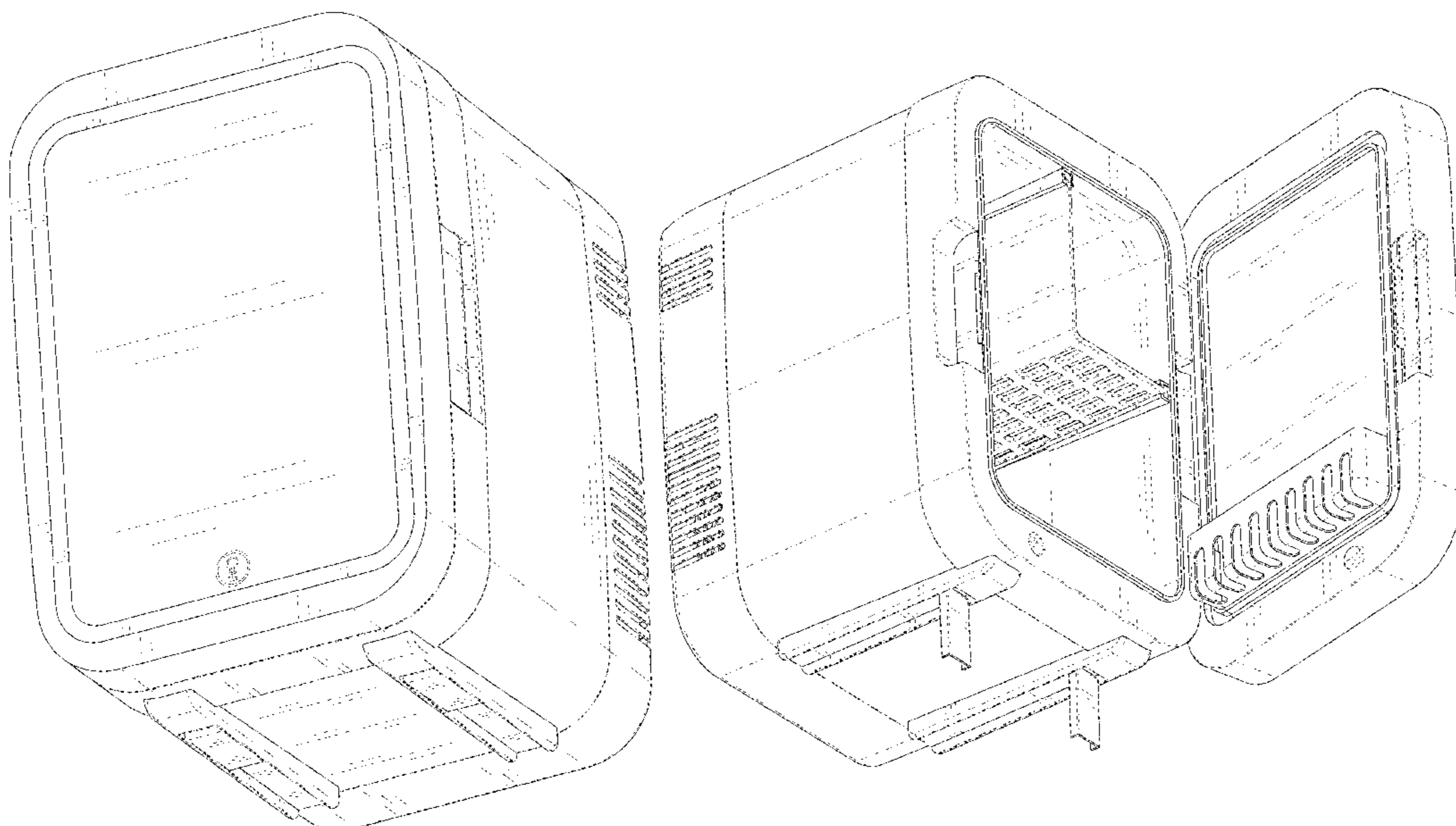

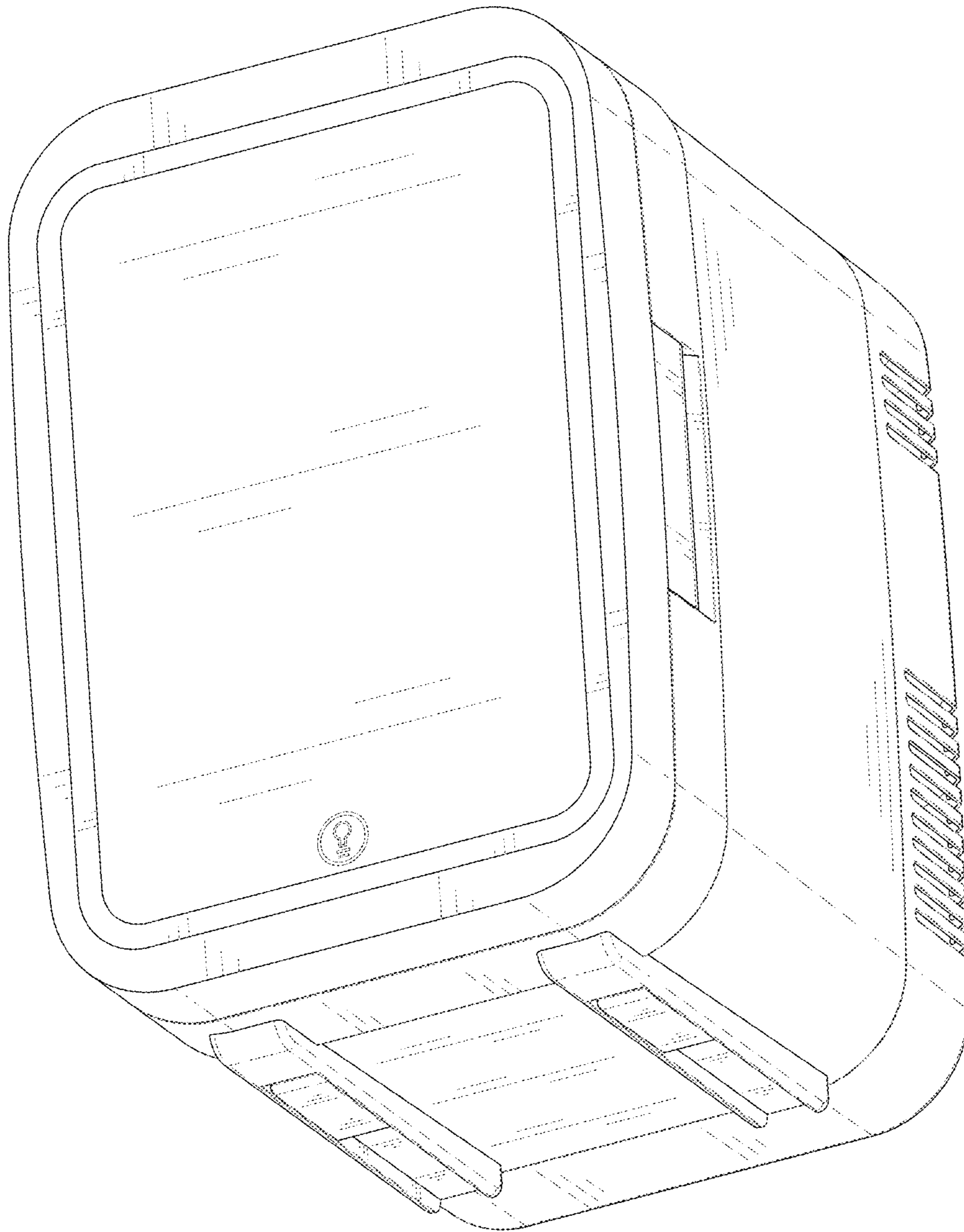

FIG. 1

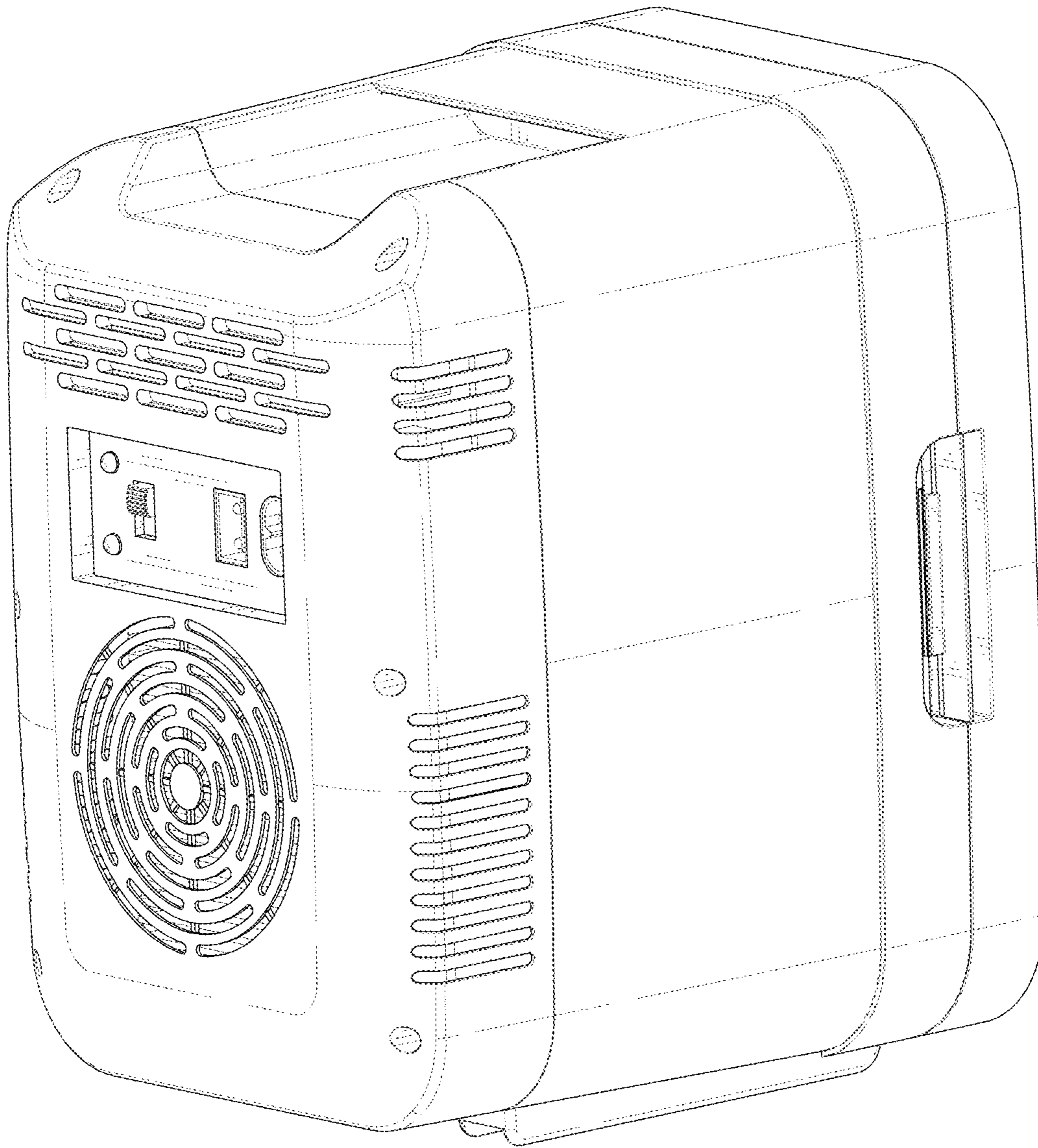

FIG. 2

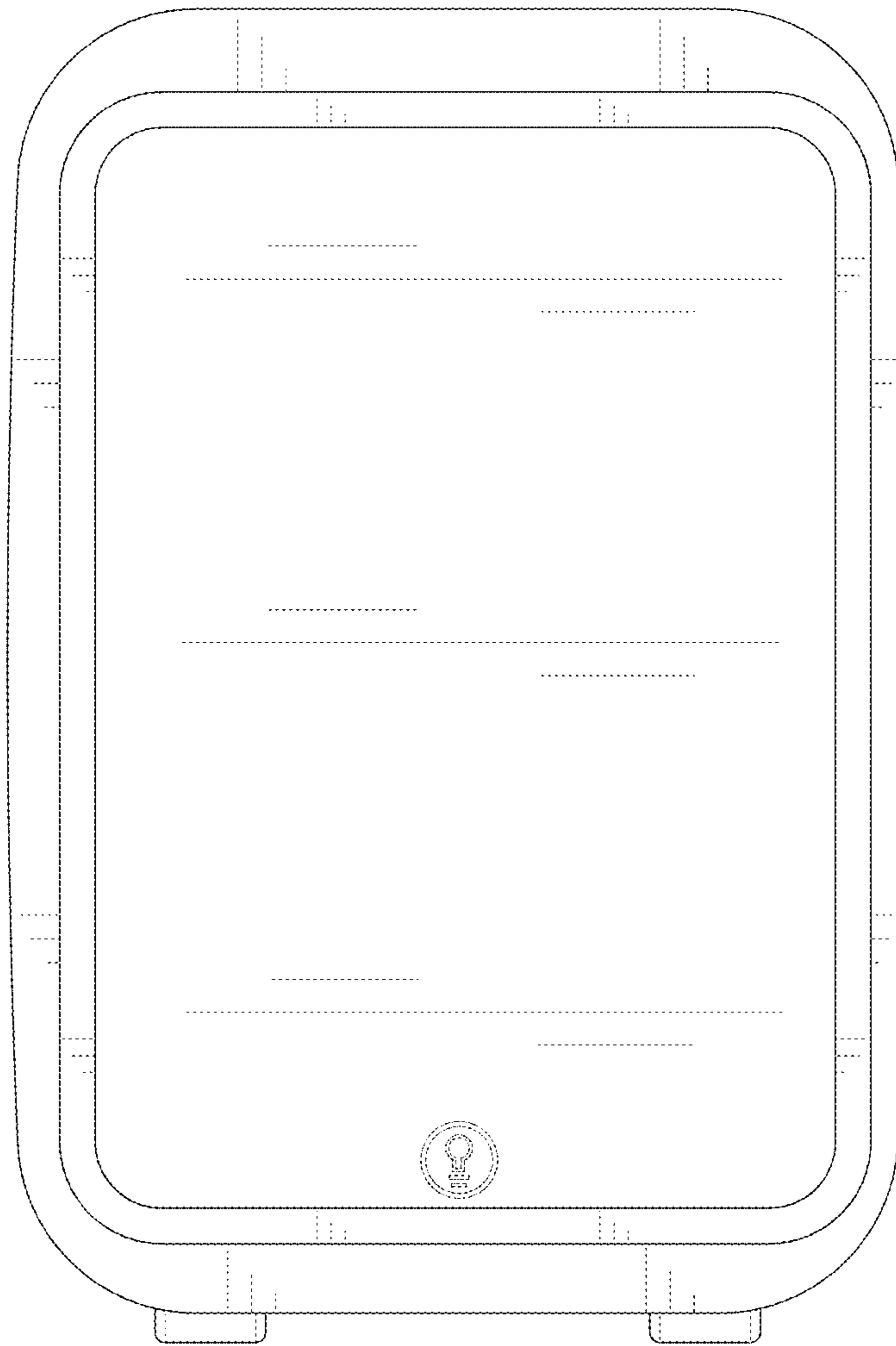

FIG. 3

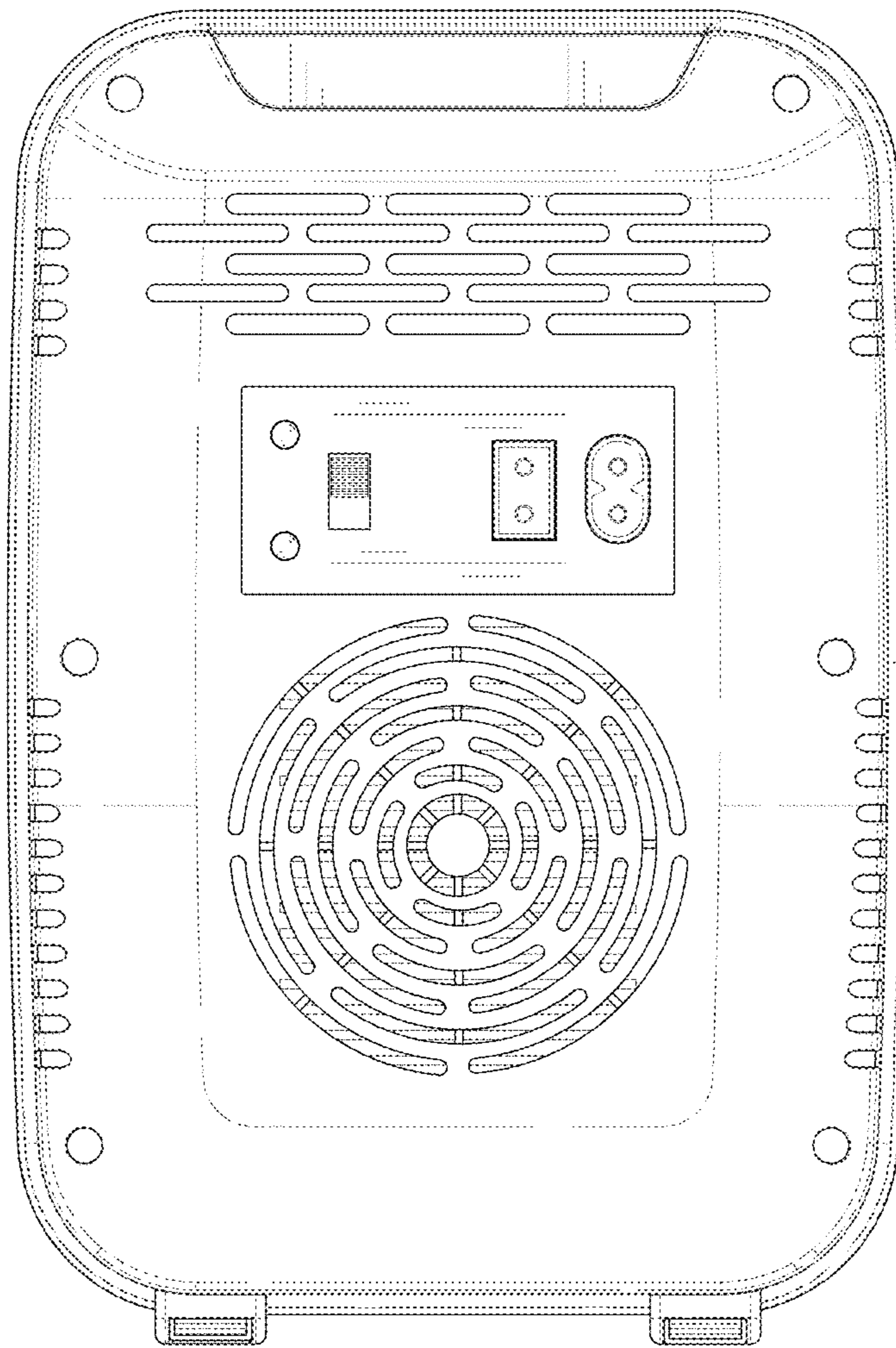

FIG. 4

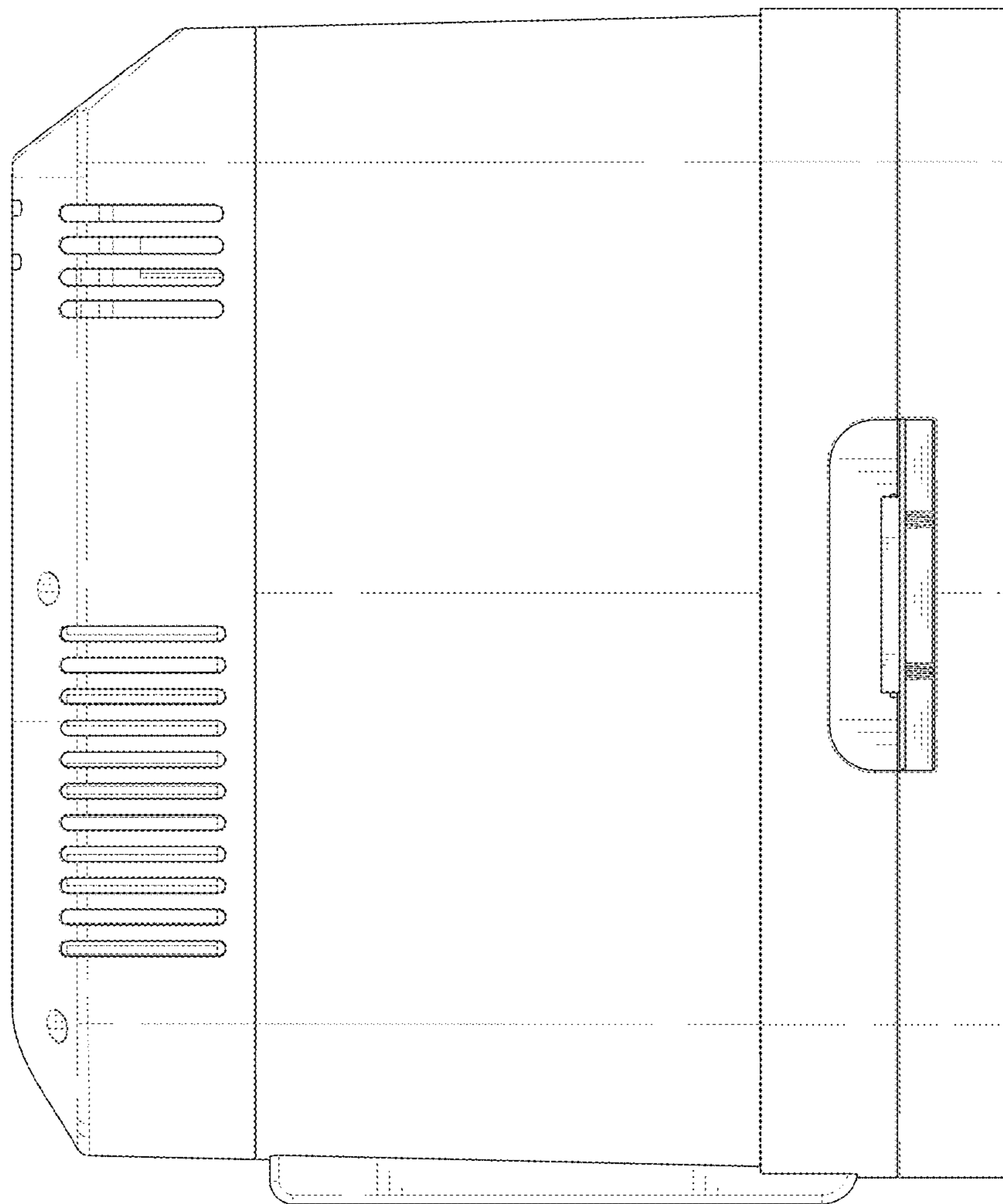

FIG. 5

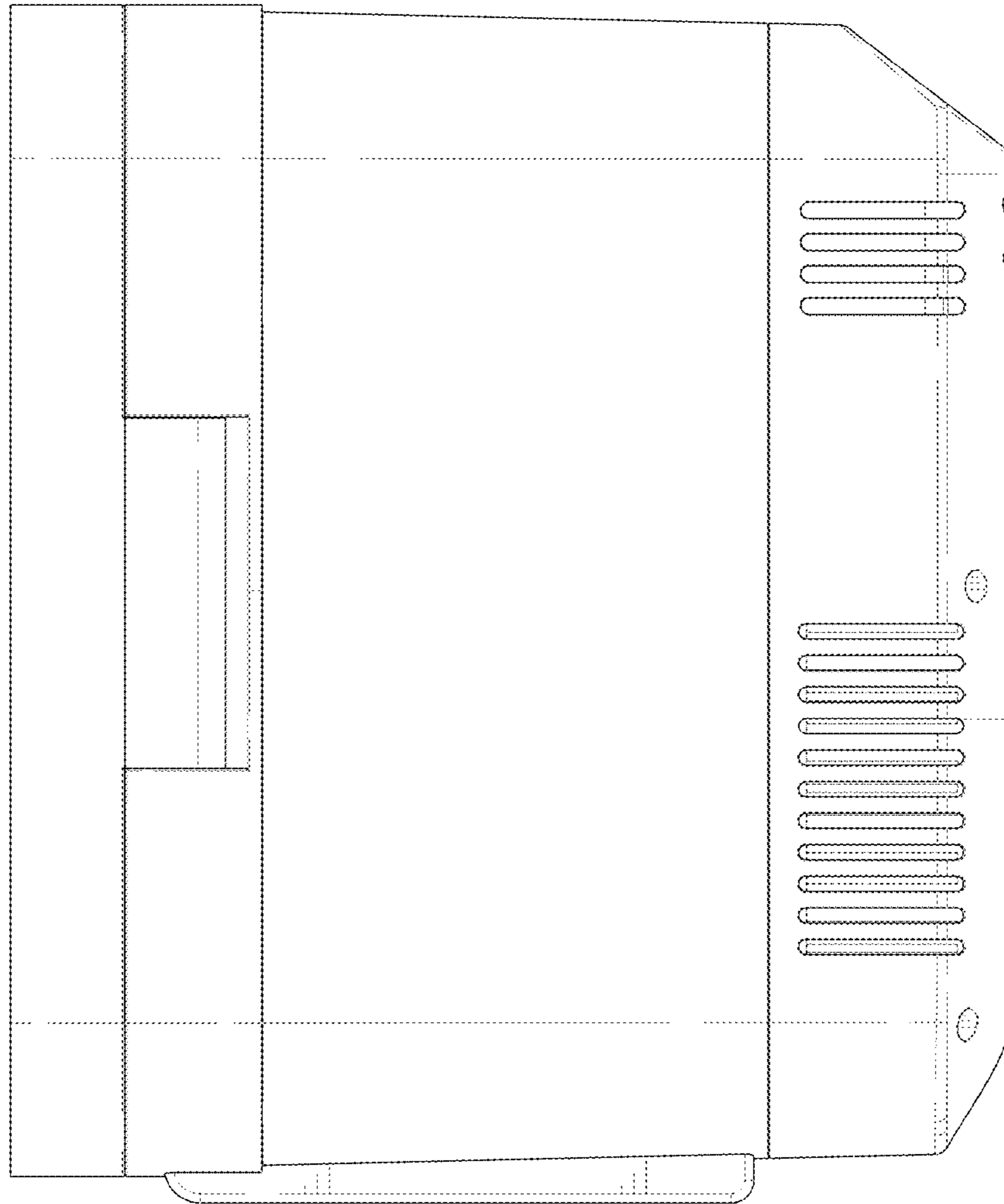

FIG. 6

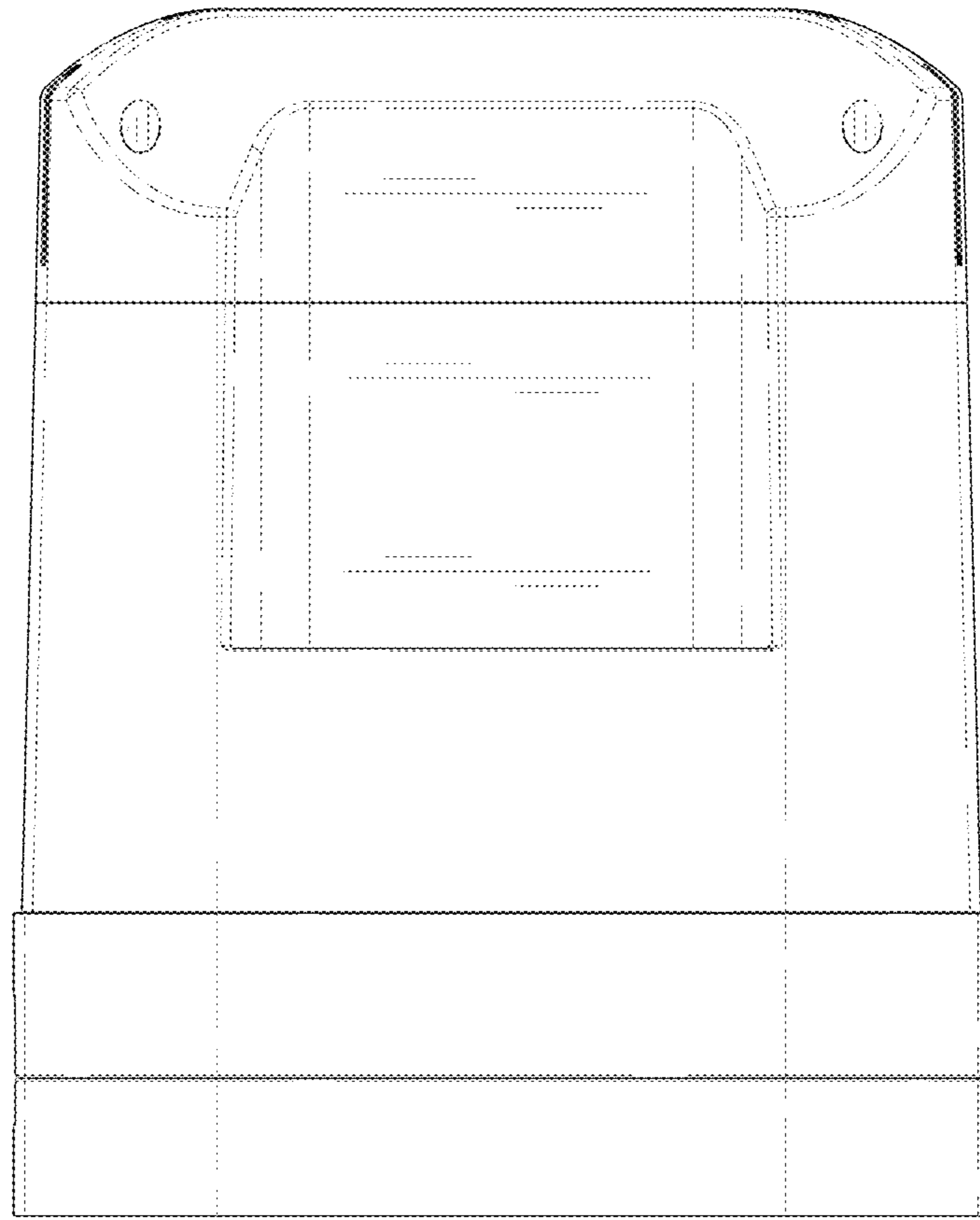

FIG. 7

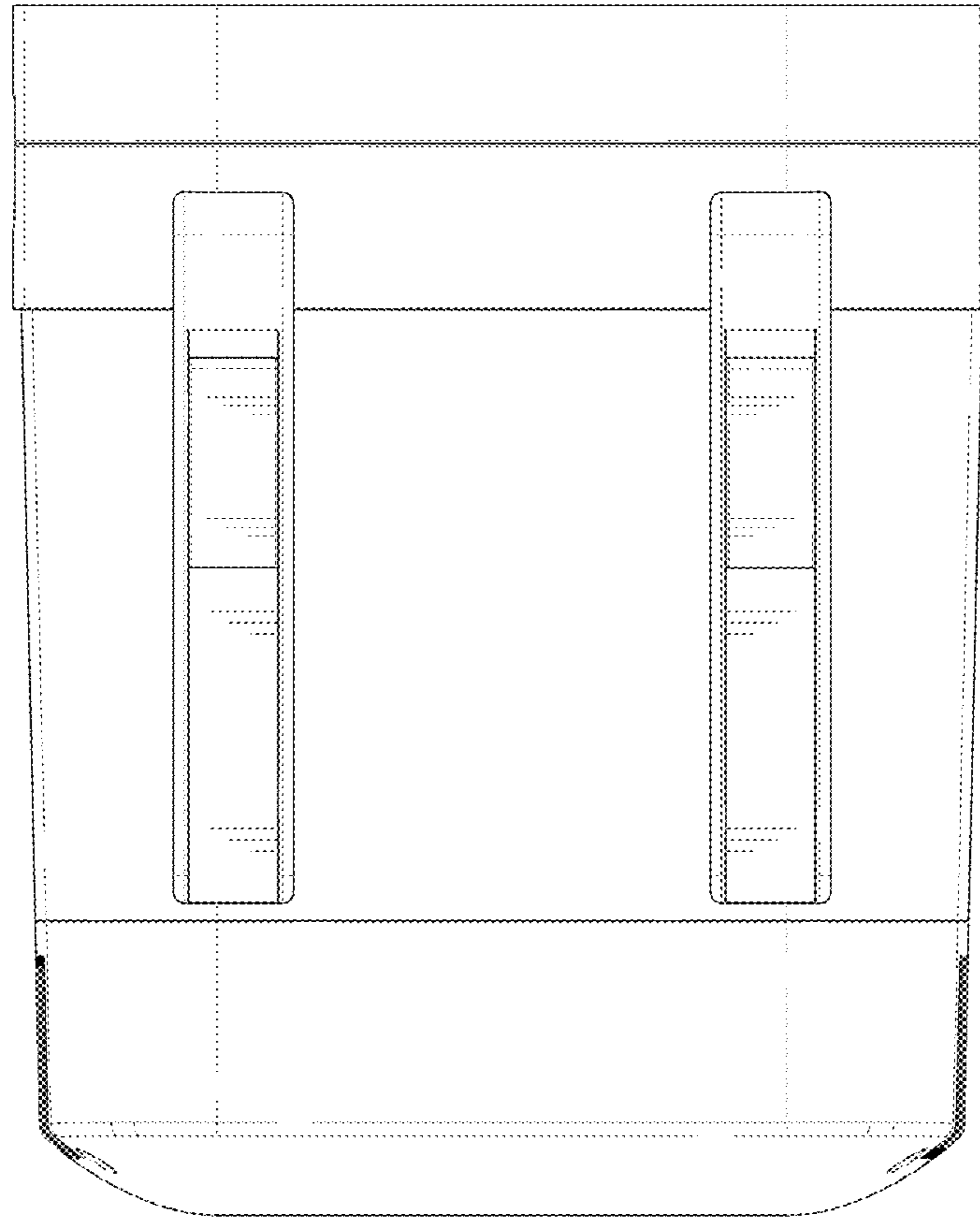

FIG. 8

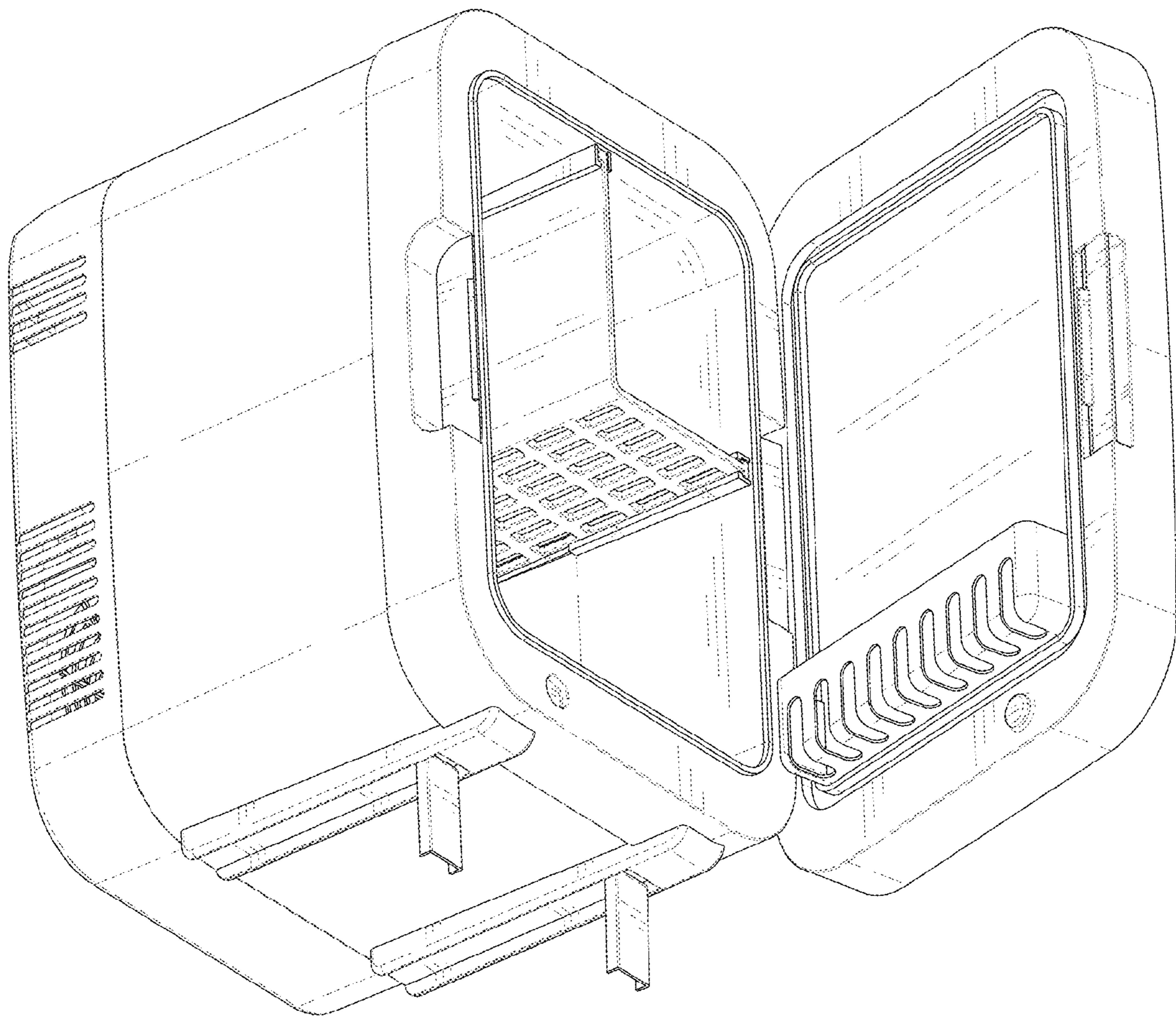

FIG. 9