



US00D965595S

(12) **United States Design Patent**  
**Zhu**

(10) **Patent No.:** **US D965,595 S**

(45) **Date of Patent:** **\*\* Oct. 4, 2022**

(54) **MOUSE**

(71) Applicant: **Shenzhen Qihang international network business Co., Ltd, Shenzhen (CN)**

(72) Inventor: **Jingfeng Zhu, Shenzhen (CN)**

(73) Assignee: **Shenzhen Qihang international network business Co., Ltd, Shenzhen (CN)**

(\*\*) Term: **15 Years**

(21) Appl. No.: **29/773,501**

(22) Filed: **Mar. 10, 2021**

(51) **LOC (13) Cl.** ..... **14-03**

(52) **U.S. Cl.**  
USPC ..... **D14/410; D14/402**

(58) **Field of Classification Search**  
USPC ..... D14/402-411, 356, 388, 389, 383-385, D14/417, 426; 345/156-167; 463/36-38; 358/471, 473; 273/148 B  
CPC ..... G06F 3/03543; G06F 2203/0333; G06F 3/039; G06F 3/038; G06F 2203/0384  
See application file for complete search history.

(56) **References Cited**

**U.S. PATENT DOCUMENTS**

D354,484 S \* 1/1995 Skaggs ..... D14/410  
D424,550 S \* 5/2000 Su ..... D14/410

D464,352 S \* 10/2002 Kerestegian ..... D14/408  
D464,651 S \* 10/2002 Kerestegian ..... D14/408  
D489,723 S \* 5/2004 Fisher ..... D14/408  
D665,806 S \* 8/2012 Lee ..... D14/408  
D844,000 S \* 3/2019 Lee ..... D14/410  
D852,193 S \* 6/2019 Chou ..... D14/410  
D903,679 S \* 12/2020 Xu ..... D14/410  
D904,409 S \* 12/2020 Xu ..... D14/410  
D908,700 S \* 1/2021 Chan ..... D14/402  
D925,537 S \* 7/2021 Carey ..... D14/409  
D925,538 S \* 7/2021 Twohig ..... D14/410

\* cited by examiner

*Primary Examiner* — Austin Murphy

(74) *Attorney, Agent, or Firm* — True Shepherd LLC; Andrew C. Cheng

(57) **CLAIM**

The ornamental design for a mouse, as shown and described.

**DESCRIPTION**

FIG. 1 is a front and top perspective view of a mouse, showing my new design;  
FIG. 2 is a rear and bottom perspective view thereof;  
FIG. 3 is a front elevation view thereof;  
FIG. 4 is a rear elevation view thereof;  
FIG. 5 is a left side elevation view thereof;  
FIG. 6 is a right side elevation view thereof;  
FIG. 7 is a top plan view thereof; and,  
FIG. 8 is a bottom plan view thereof.  
The broken lines in the figures illustrate portions of the mouse that form no part of the claimed design.

**1 Claim, 8 Drawing Sheets**

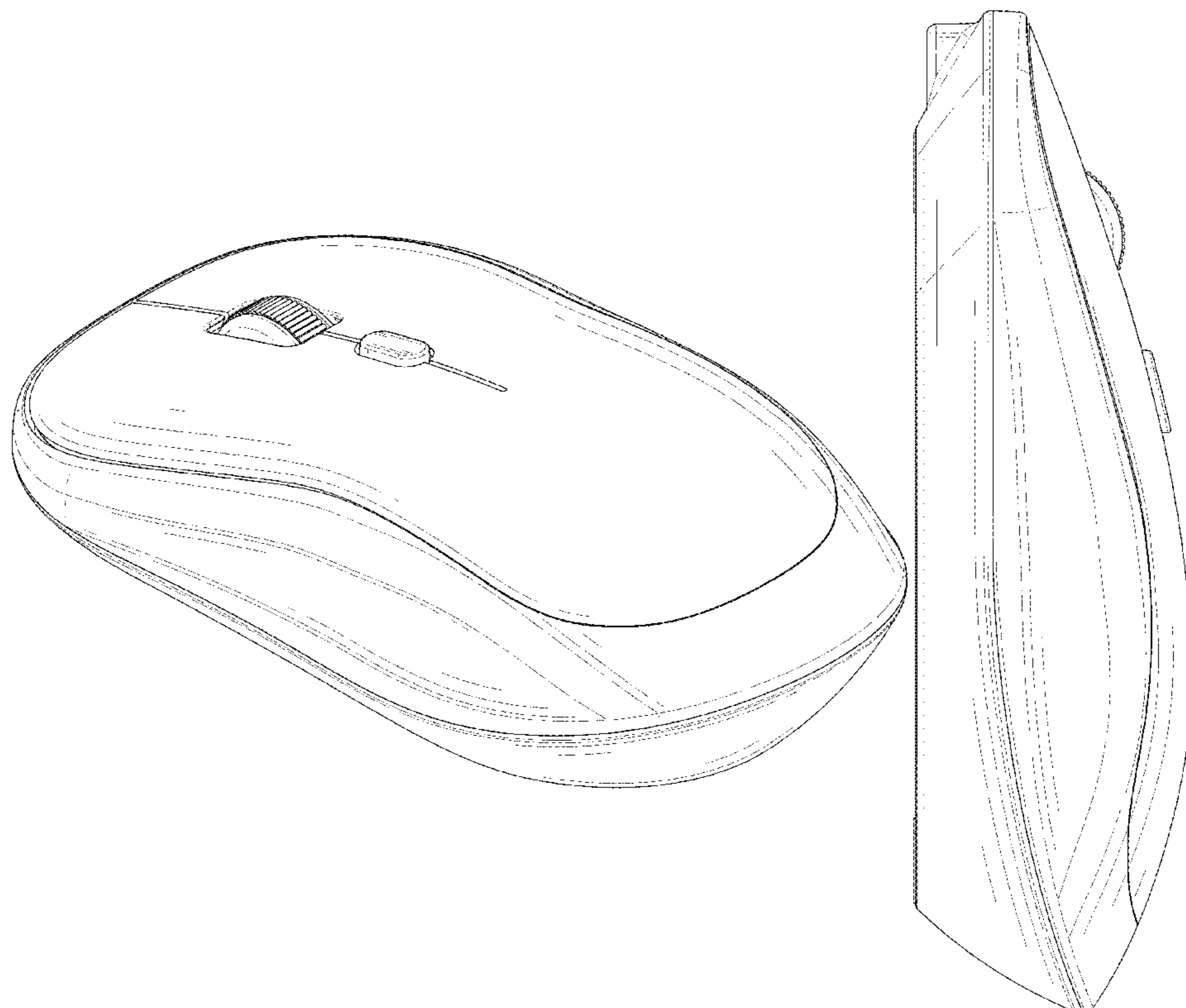

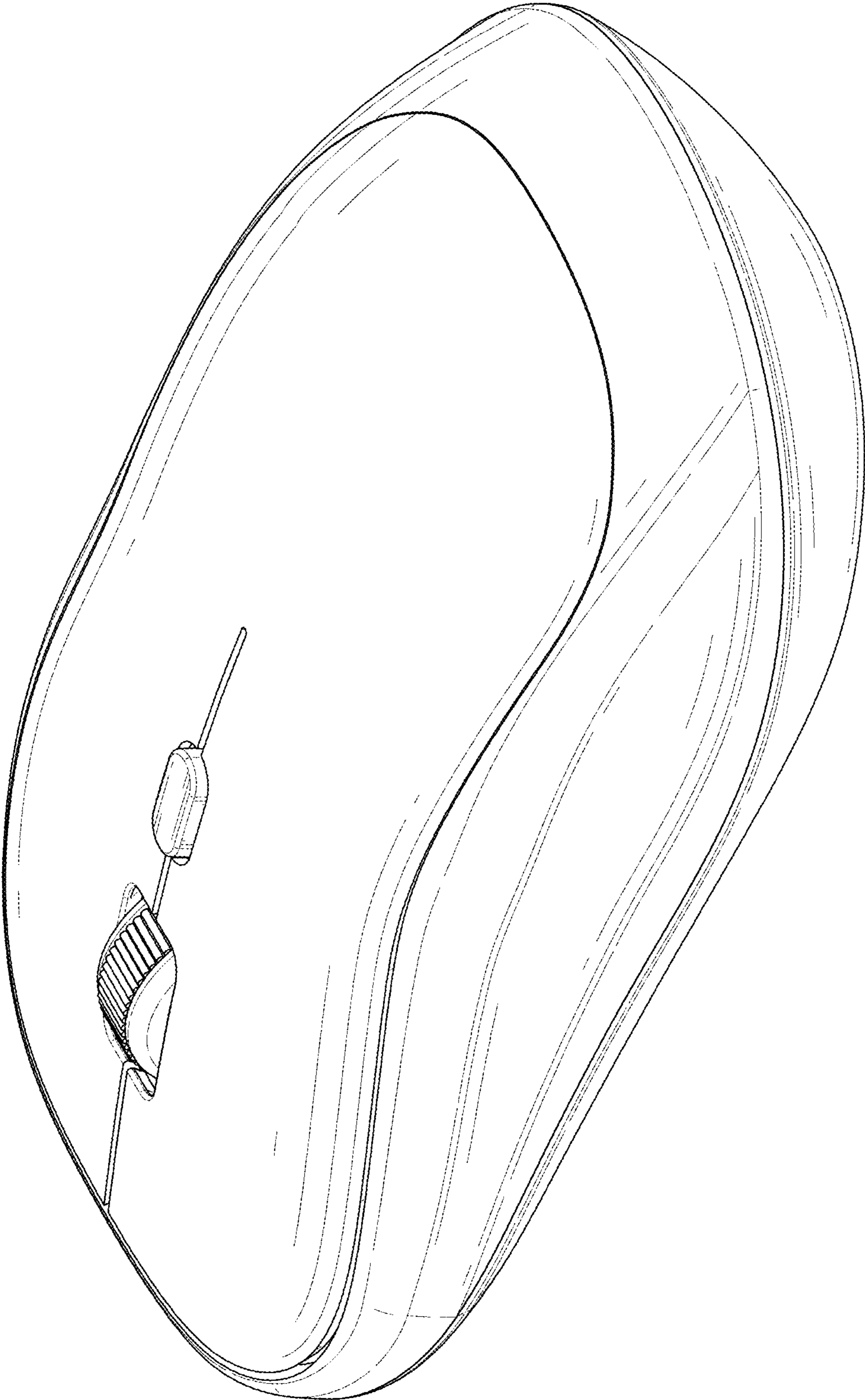

FIG. 1

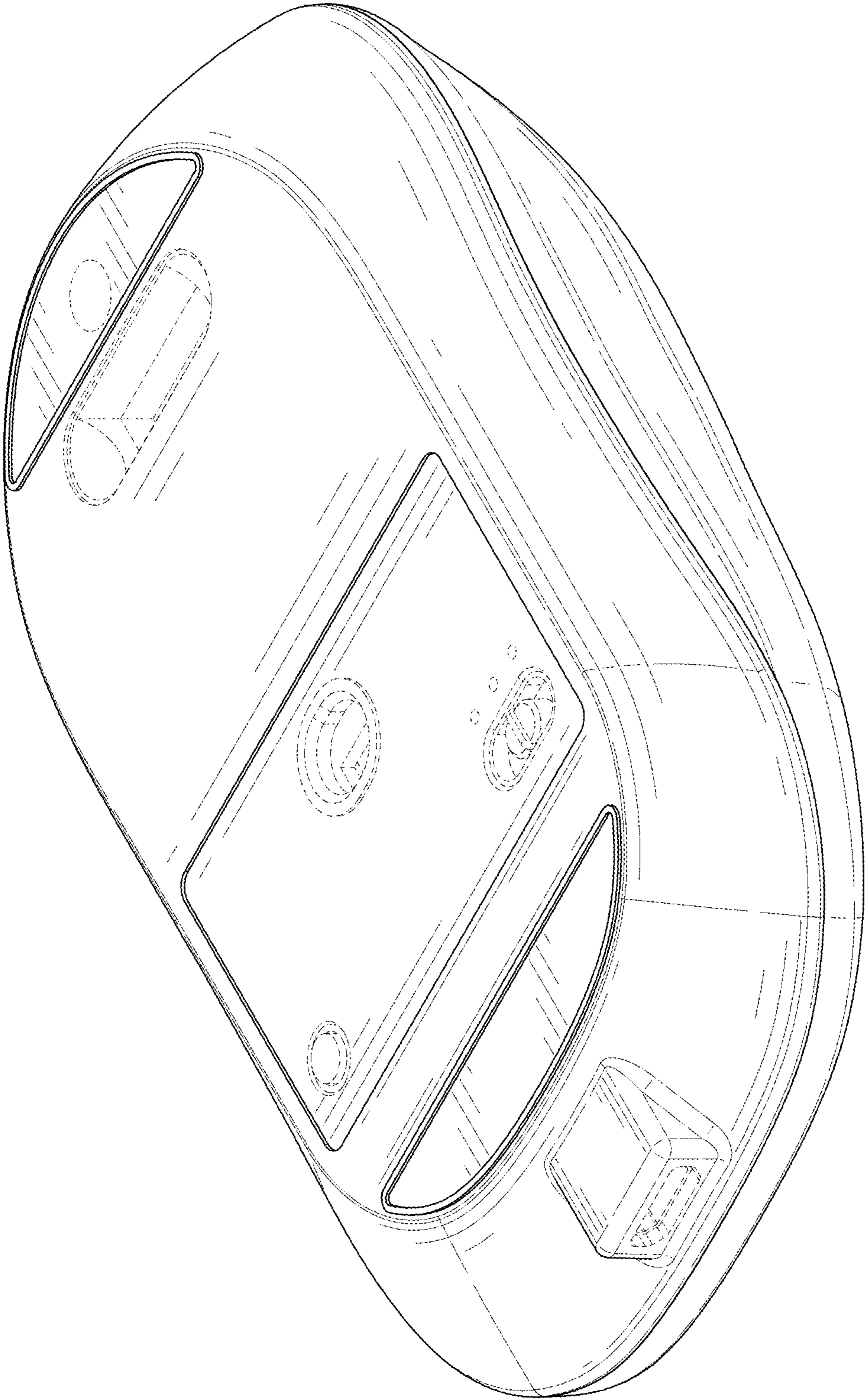

FIG. 2

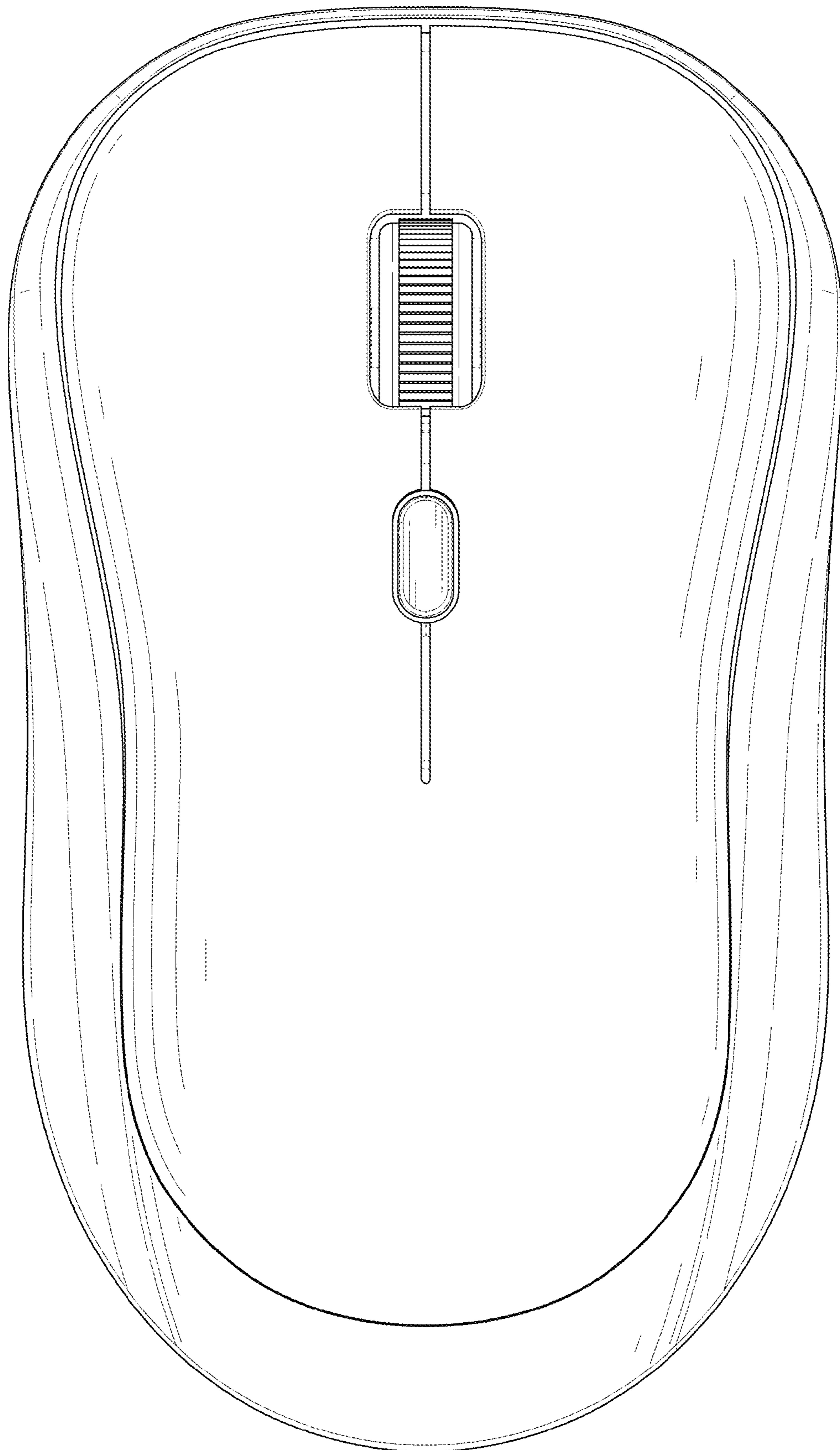

FIG. 3

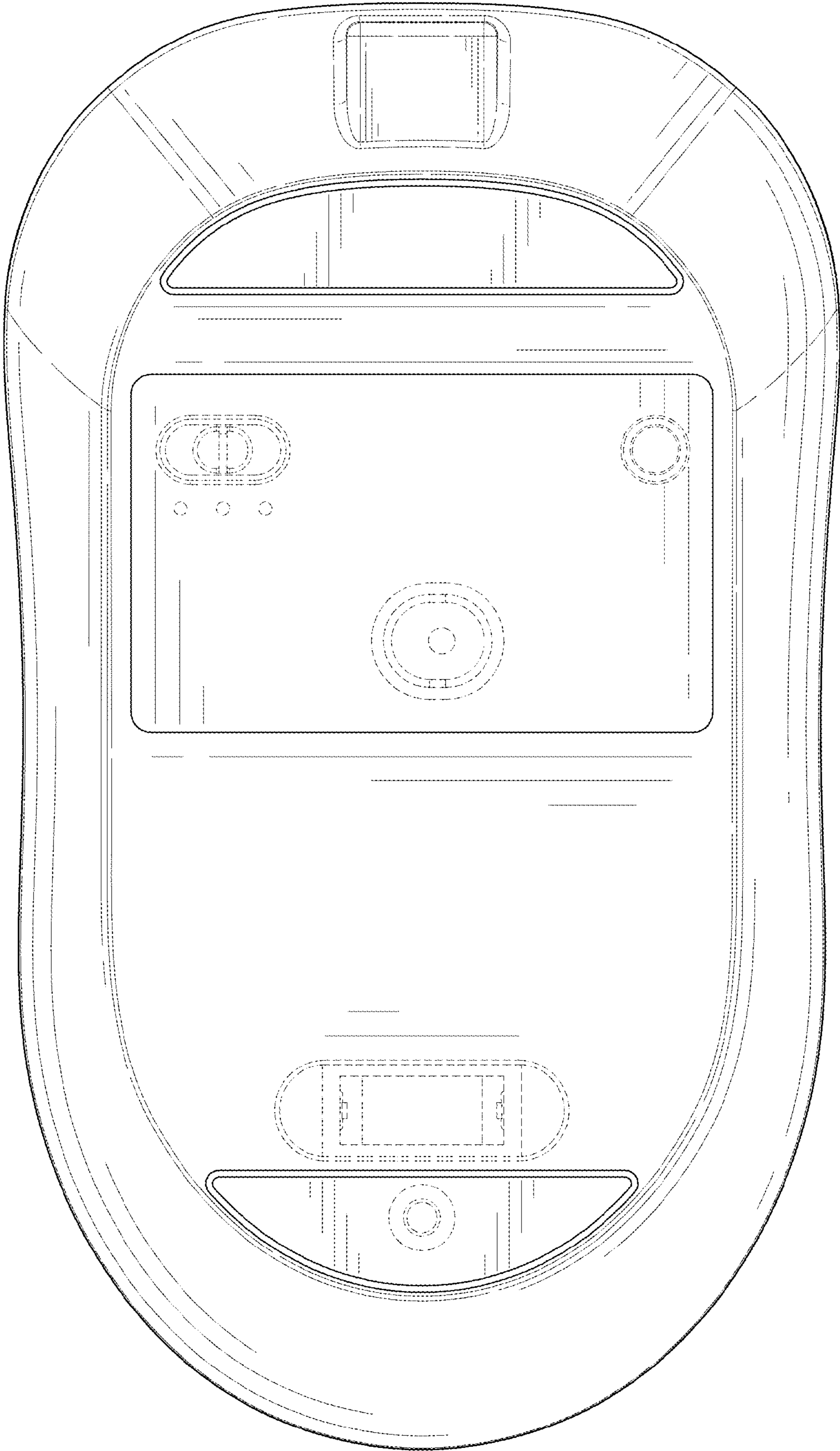

FIG. 4

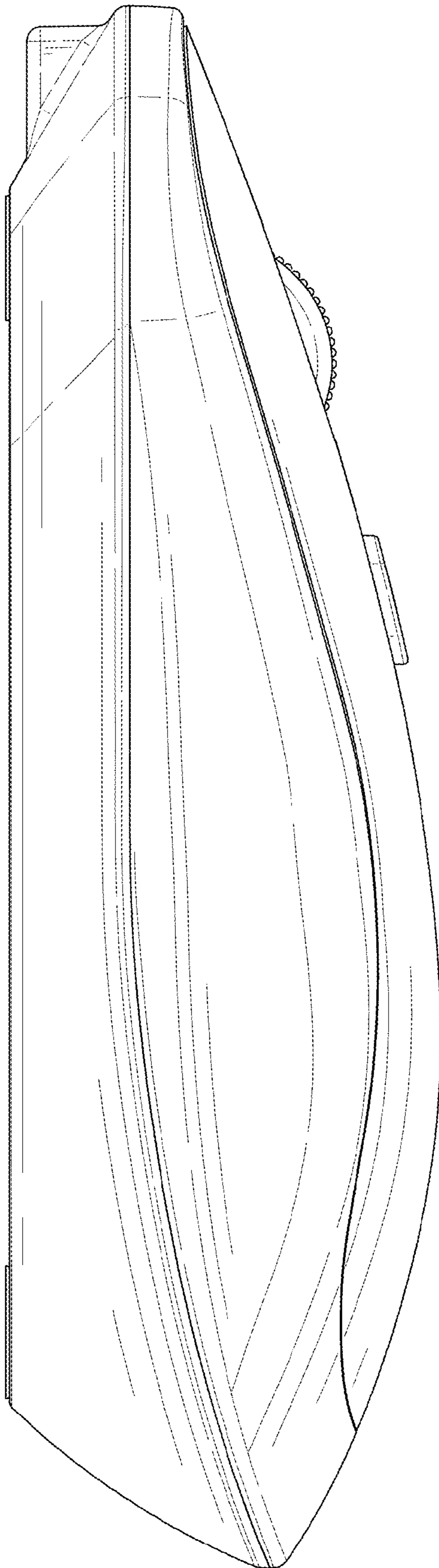

FIG. 5

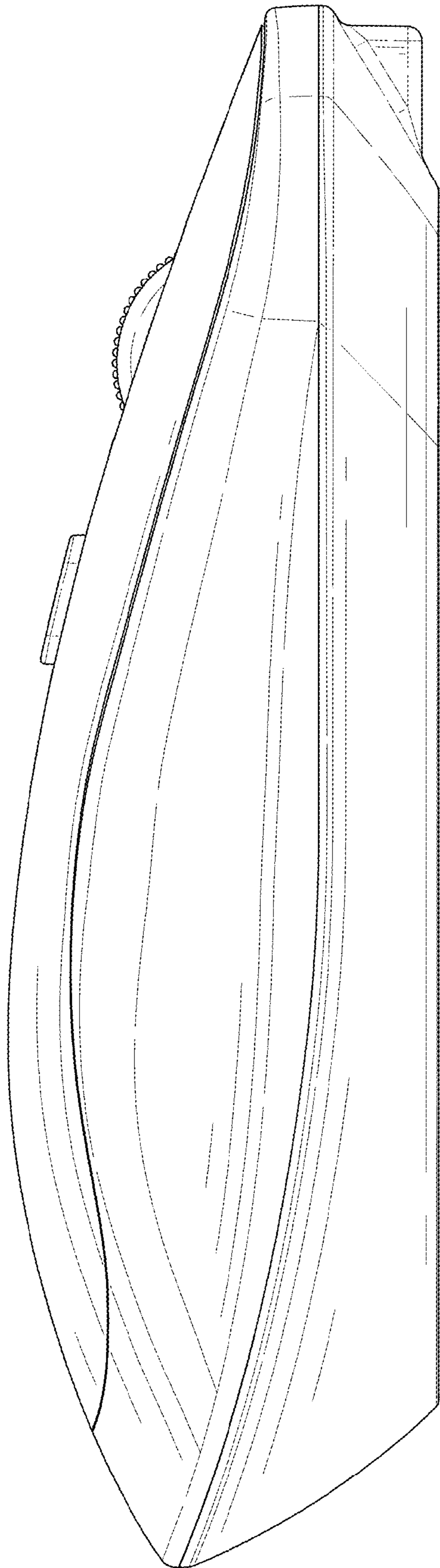

FIG. 6

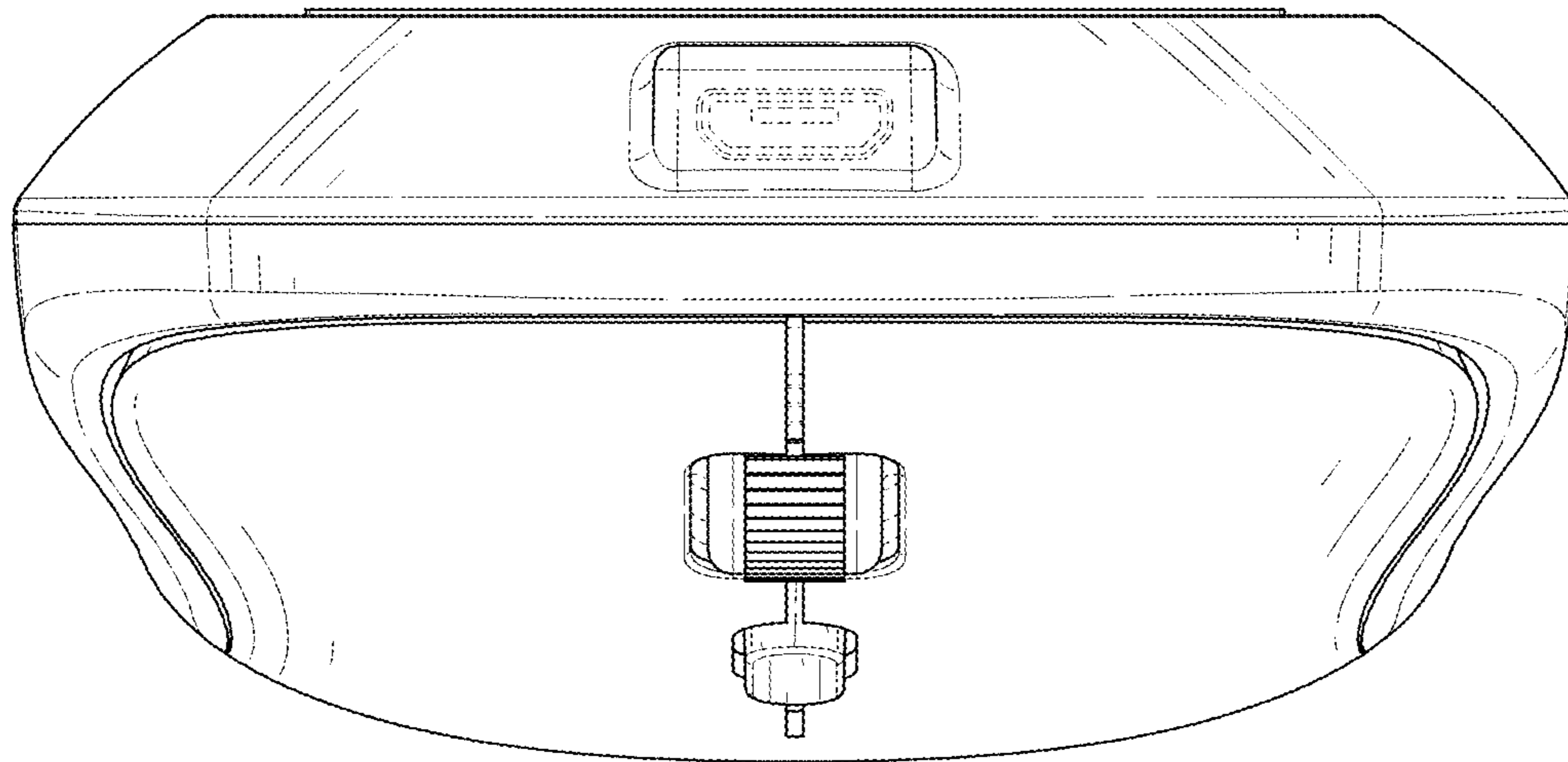

FIG. 7



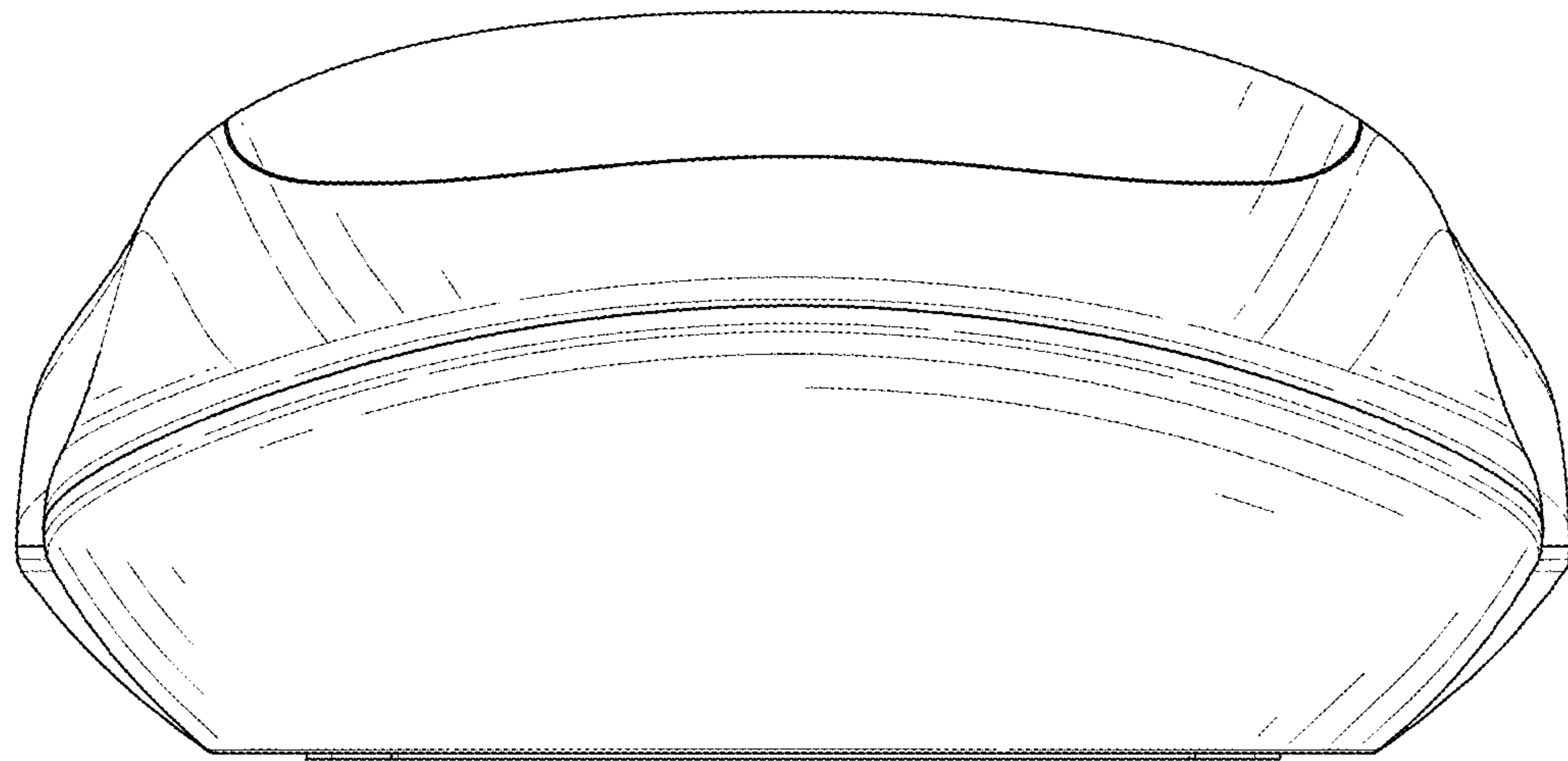

FIG. 8