



US00D96551S

(12) **United States Design Patent**
Liu

(10) **Patent No.:** **US D965,551 S**
(45) **Date of Patent:** **** Oct. 4, 2022**

(54) **WIRELESS HEADBAND**

DESCRIPTION

(71) Applicant: **Lei Liu**, Pingxiang (CN)
(72) Inventor: **Lei Liu**, Pingxiang (CN)
(**) Term: **15 Years**
(21) Appl. No.: **29/825,184**
(22) Filed: **Jan. 29, 2022**
(51) **LOC (13) Cl.** **14-03**
(52) **U.S. Cl.**
USPC **D14/192**
(58) **Field of Classification Search**
USPC D2/865, 867, 875, 877; D6/601;
D14/192, 205, 217, 223, 372
CPC F21V 21/084; A61F 9/027
See application file for complete search history.

(56) **References Cited**

U.S. PATENT DOCUMENTS

D284,080 S * 6/1986 Swezey D2/866
4,727,599 A * 2/1988 Rappaport H04R 5/0335
455/352
D315,812 S * 3/1991 Cionni D29/112
D384,790 S * 10/1997 Juergens D2/866

(Continued)

OTHER PUBLICATIONS

[Sleep Headphones Bluetooth Sleeping Headband:], available in Amazon.com, date first available Mar. 24, 2022 [online], [site visited Aug. 4, 2022], Available from the internet URL: https://www.amazon.com/Sleep-Headphones-Bluetooth-Sleeping-Headband/dp/B09WDKTWWR/ref=sr_1_42 (Year: 2022).*

Primary Examiner — Khawaja Anwar
Assistant Examiner — Megan Tiana Rakos

(57) **CLAIM**

The ornamental design for a wireless headband, as shown and described.

FIG. 1 is a perspective view of a first embodiment of a wireless headband showing my new design;
FIG. 2 is another perspective view thereof;
FIG. 3 is a front elevational view thereof;
FIG. 4 is a rear elevational view thereof;
FIG. 5 is a left side elevational view thereof;
FIG. 6 is a right side elevational view thereof;
FIG. 7 is a top plan view thereof;
FIG. 8 is a bottom plan view thereof;
FIG. 9 is a perspective view of a second embodiment of the wireless headband;
FIG. 10 is another perspective view thereof;
FIG. 11 is a front elevational view thereof;
FIG. 12 is a rear elevational view thereof;
FIG. 13 is a left side elevational view thereof;
FIG. 14 is a right side elevational view thereof;
FIG. 15 is a top plan view thereof;
FIG. 16 is a bottom plan view thereof;
FIG. 17 is a perspective view of a third embodiment of the wireless headband;
FIG. 18 is another perspective view thereof;
FIG. 19 is a front elevational view thereof;
FIG. 20 is a rear elevational view thereof;
FIG. 21 is a left side elevational view thereof;
FIG. 22 is a right side elevational view thereof;
FIG. 23 is a top plan view thereof;
FIG. 24 is a bottom plan view thereof;
FIG. 25 is a perspective view of a fourth embodiment of the wireless headband;
FIG. 26 is another perspective view thereof;
FIG. 27 is a front elevational view thereof;
FIG. 28 is a rear elevational view thereof;
FIG. 29 is a left side elevational view thereof;
FIG. 30 is a right side elevational view thereof;
FIG. 31 is a top plan view thereof; and,
FIG. 32 is a bottom plan view thereof.
The broken lines in the drawings depict portions of the wireless headband that form no part of the claimed design.

1 Claim, 32 Drawing Sheets

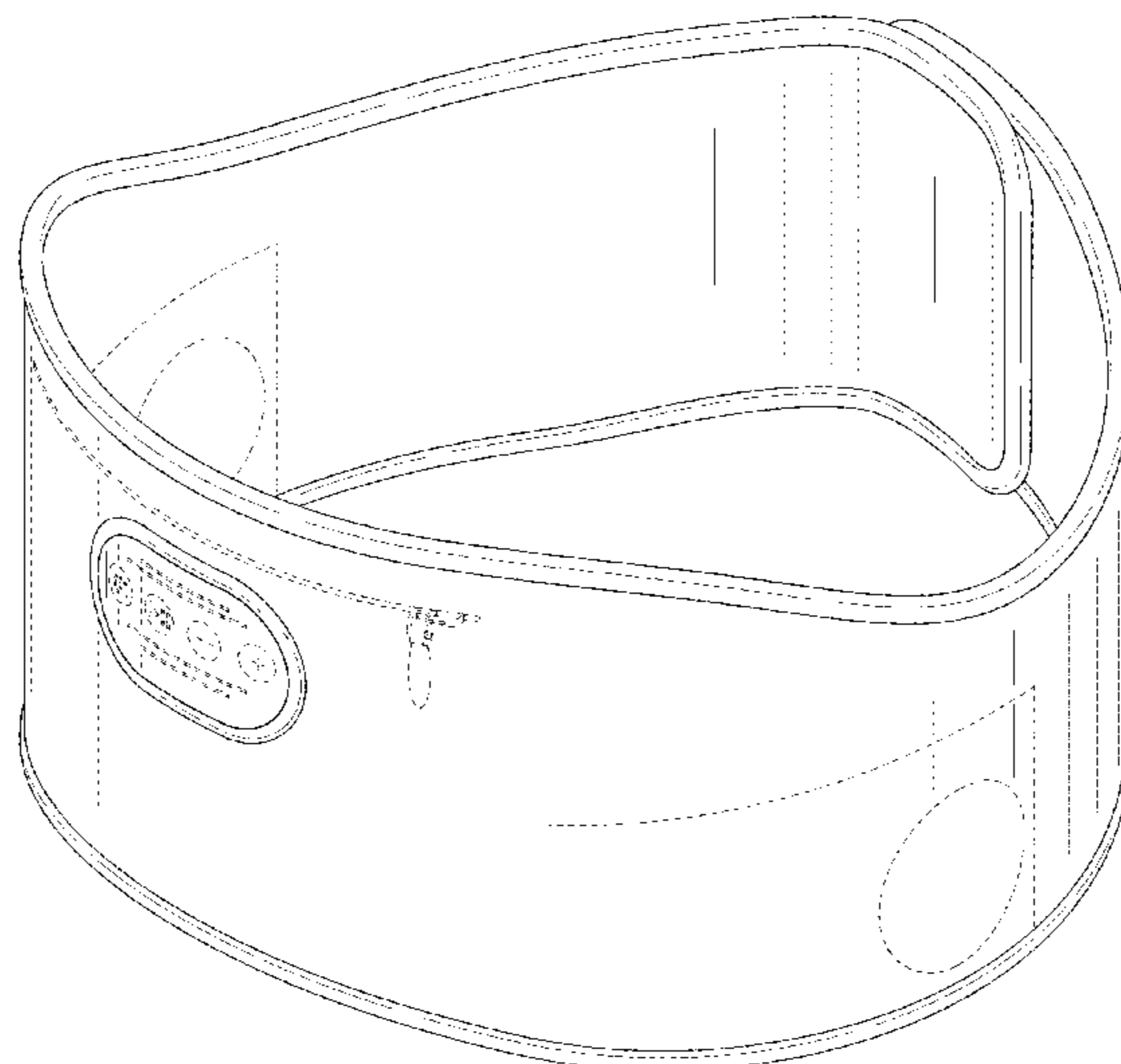

(56)

References Cited

U.S. PATENT DOCUMENTS

D547,500 S * 7/2007 Karrman A61F 11/14
D29/112
8,111,859 B2 2/2012 Phillips
8,213,670 B2 * 7/2012 Lai H04R 5/0335
381/376
D712,880 S * 9/2014 Lin D14/223
D815,806 S * 4/2018 Zundel D2/867
D832,558 S * 11/2018 Hawes D2/875
D870,062 S * 12/2019 Peng D2/866
D913,984 S * 3/2021 Li D14/192
D926,442 S * 8/2021 Lopes D29/102
D932,459 S * 10/2021 Liu D14/205
D944,494 S * 3/2022 Peng D2/875
D946,549 S * 3/2022 Wang D14/205
D949,355 S * 4/2022 Steingold A61N 5/0622
D24/209
D959,403 S * 8/2022 Li D14/205
D959,404 S * 8/2022 Li D14/205
2008/0144872 A1 * 6/2008 Phillips H04R 5/0335
381/301
2014/0321661 A1 * 10/2014 Alao H04R 1/105
381/74
2017/0238078 A1 * 8/2017 Kimble H04B 1/3888
381/74
2019/0132663 A1 * 5/2019 Lu H04R 1/1008

* cited by examiner

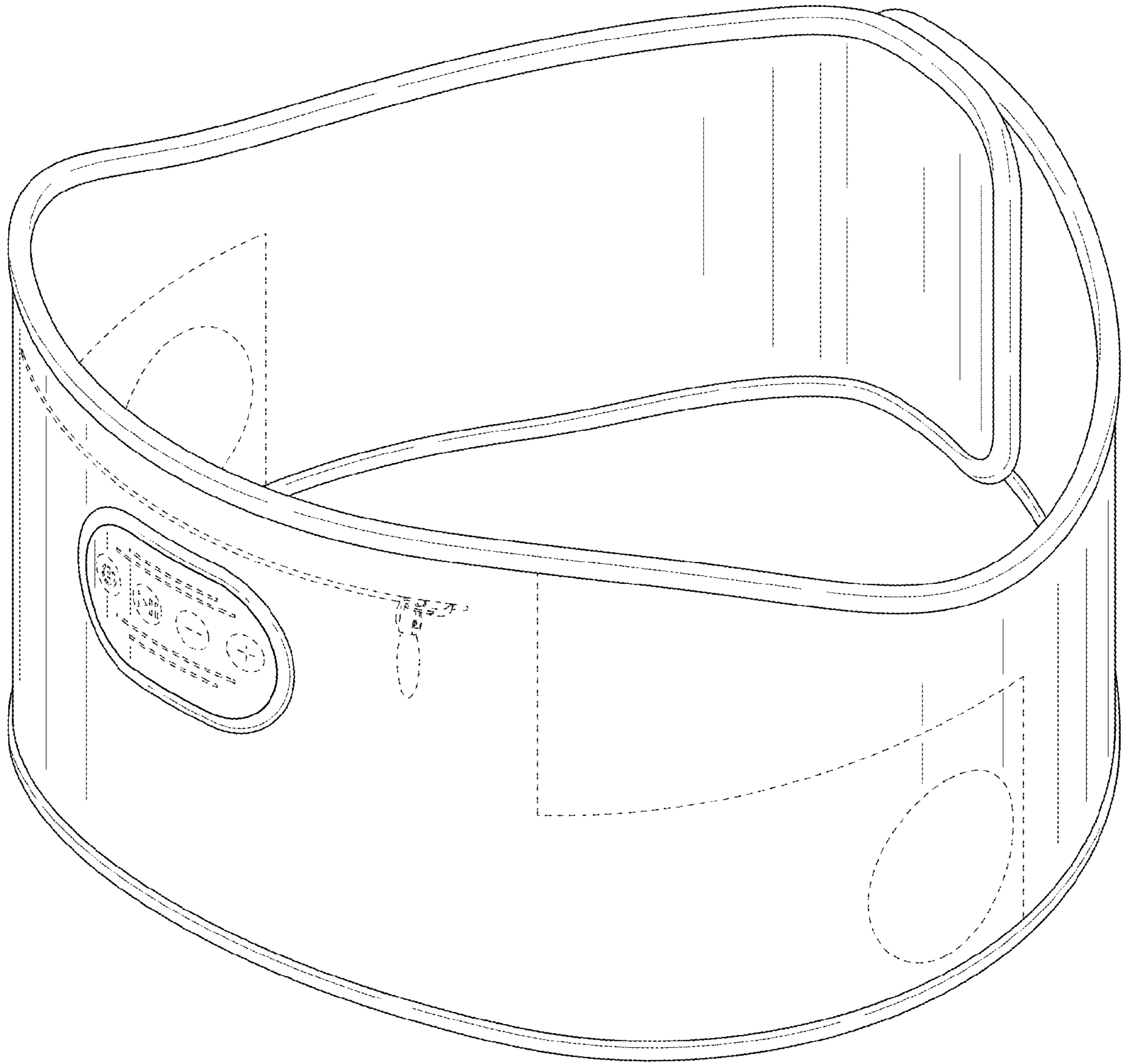

FIG. 1

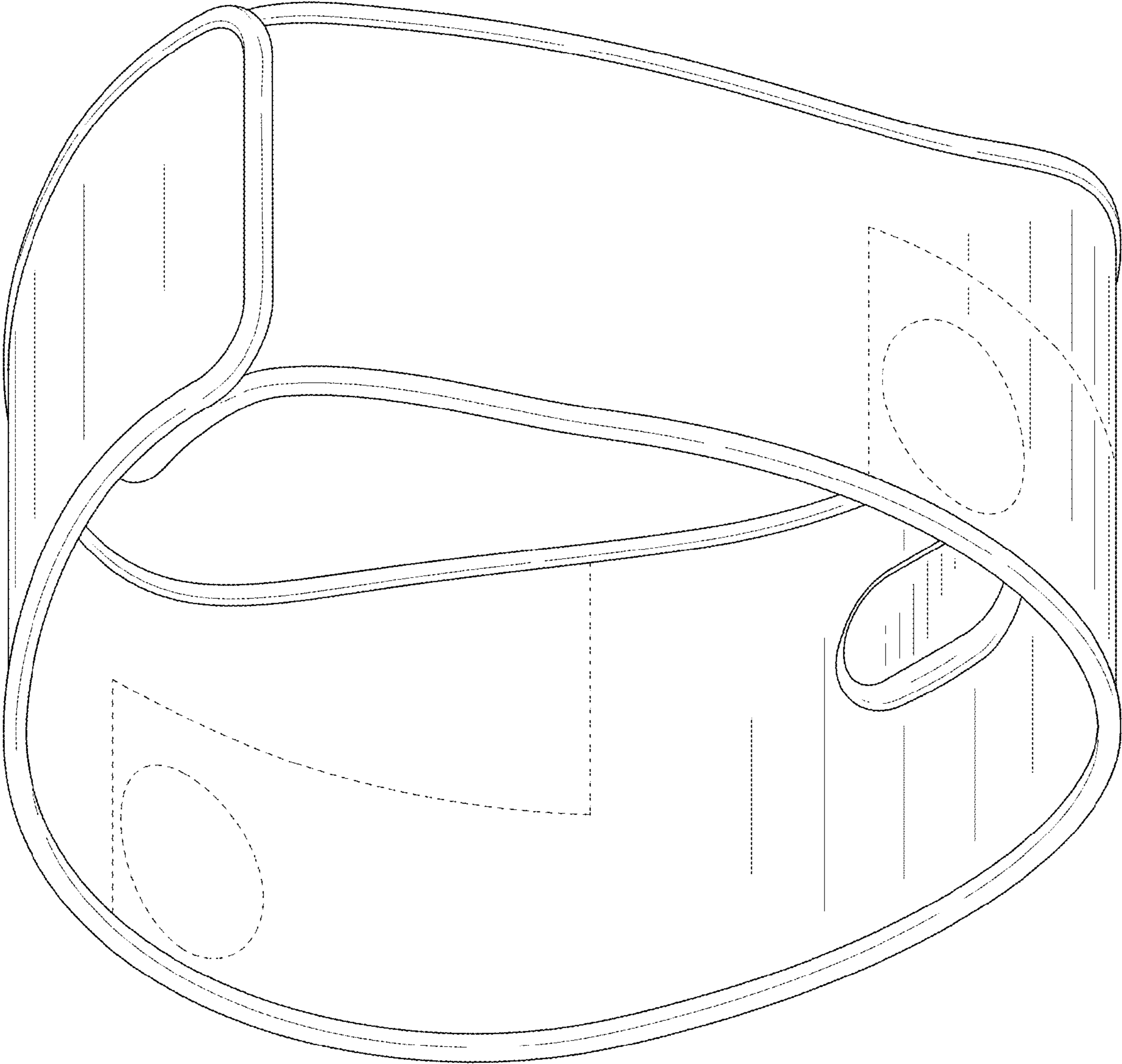

FIG. 2

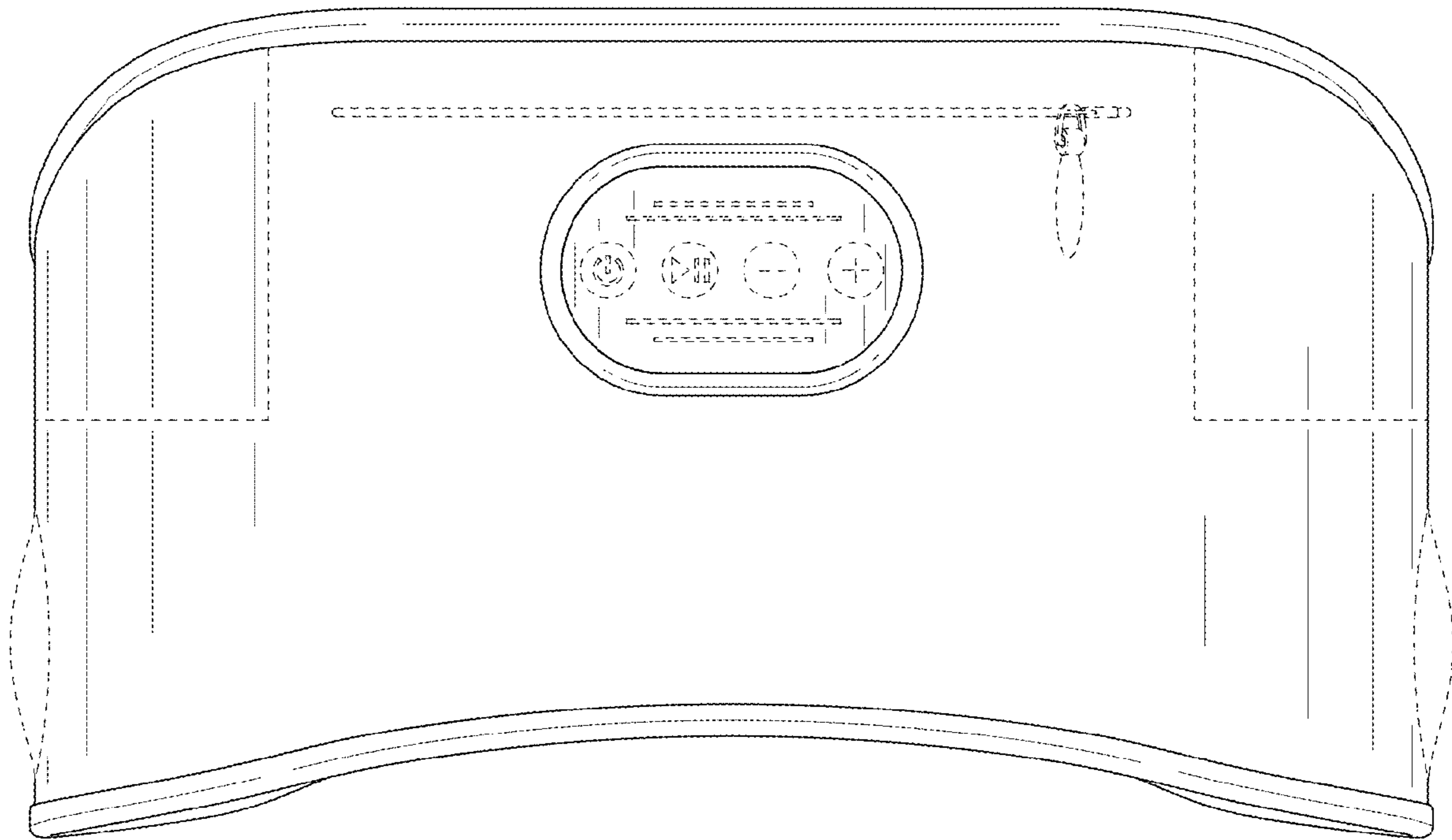

FIG. 3

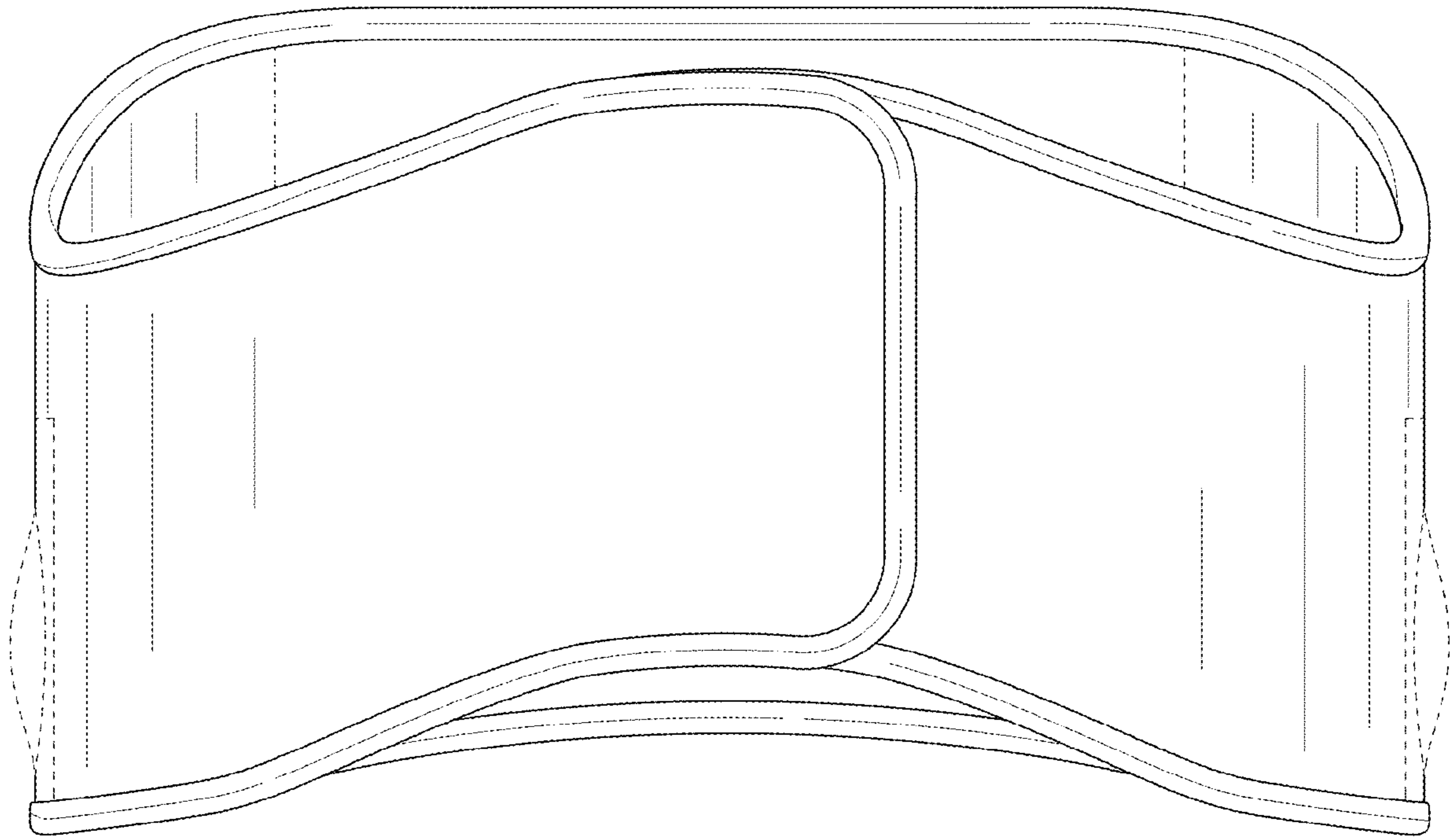

FIG. 4

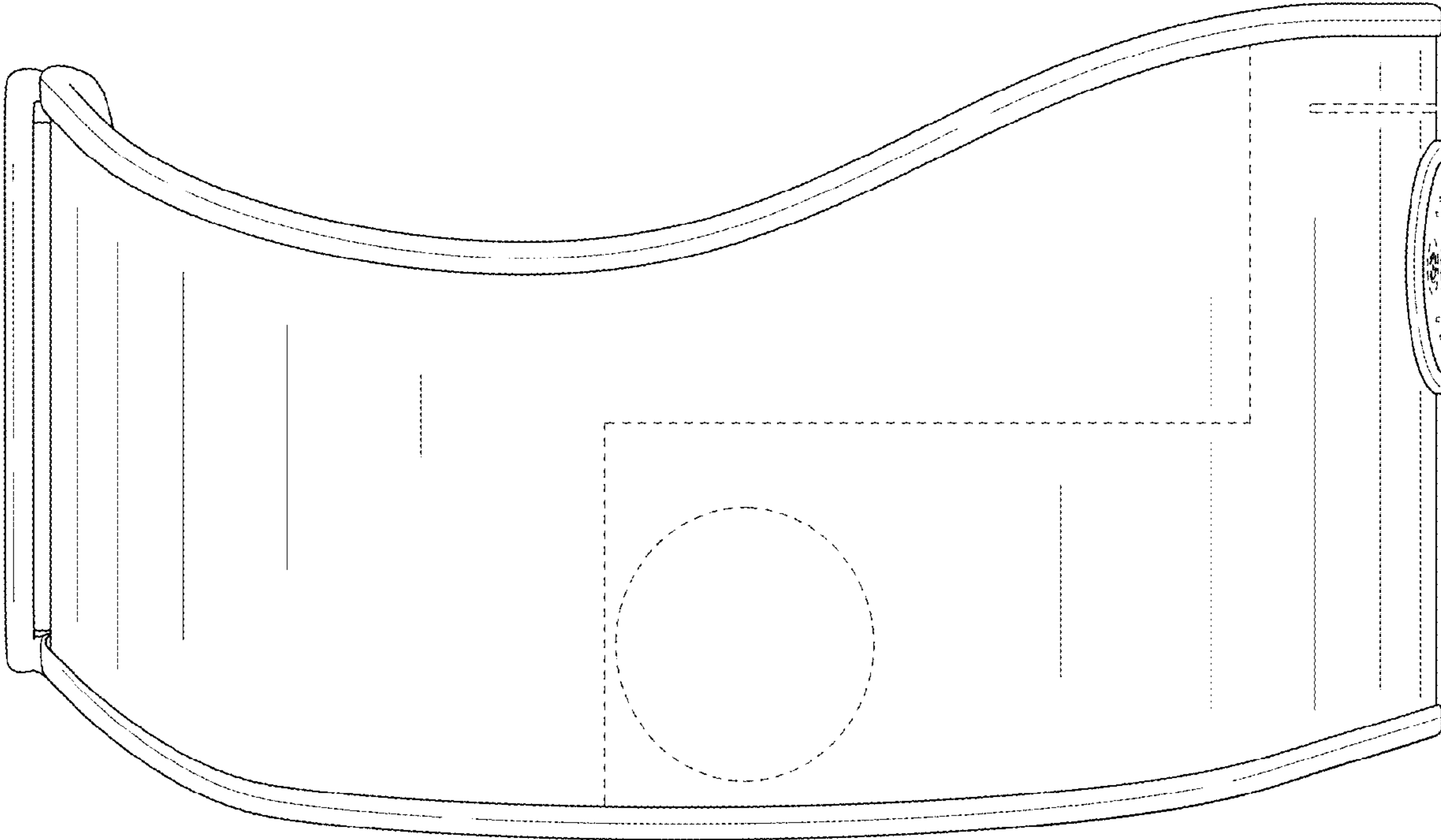

FIG. 5

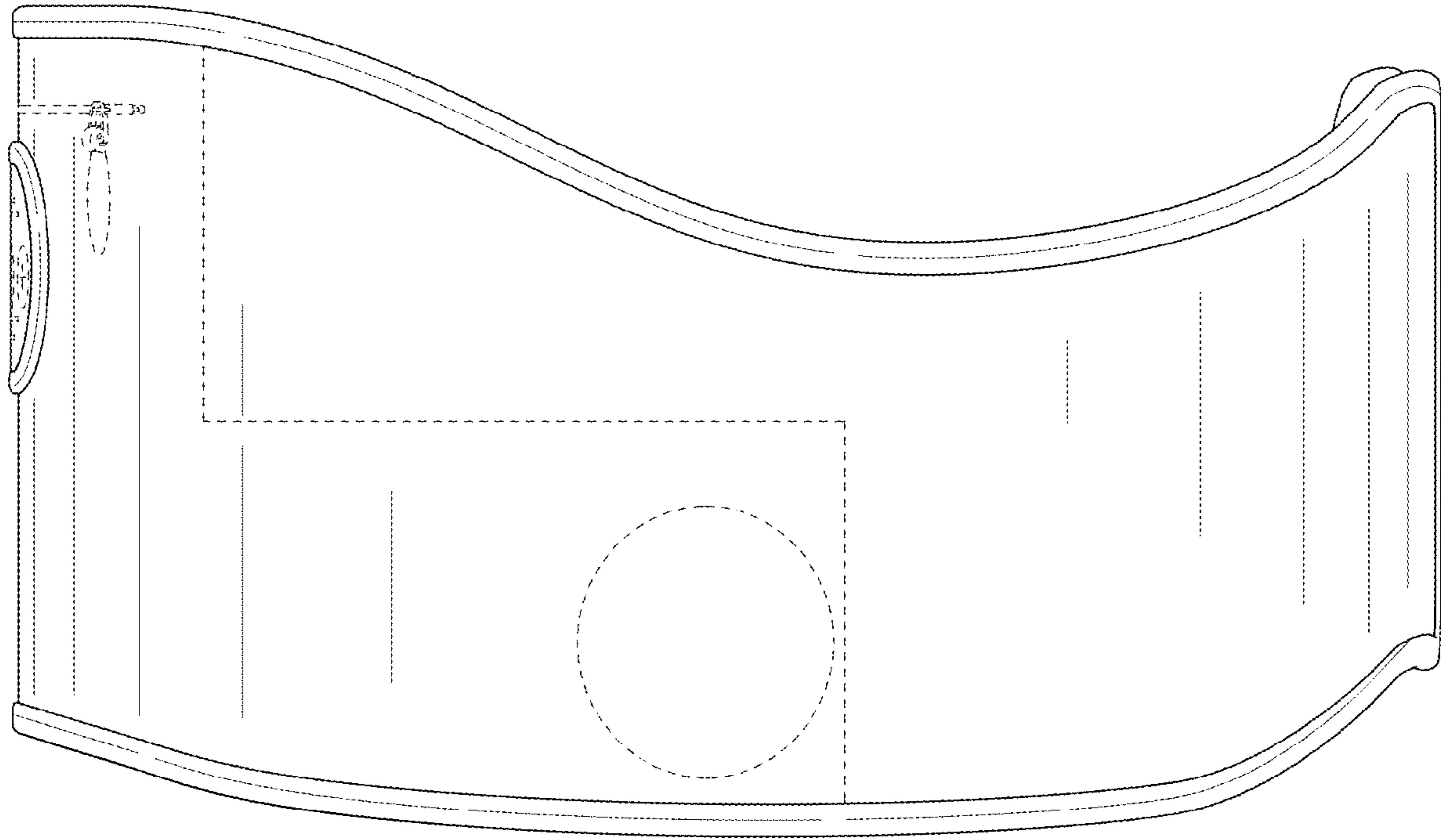

FIG. 6

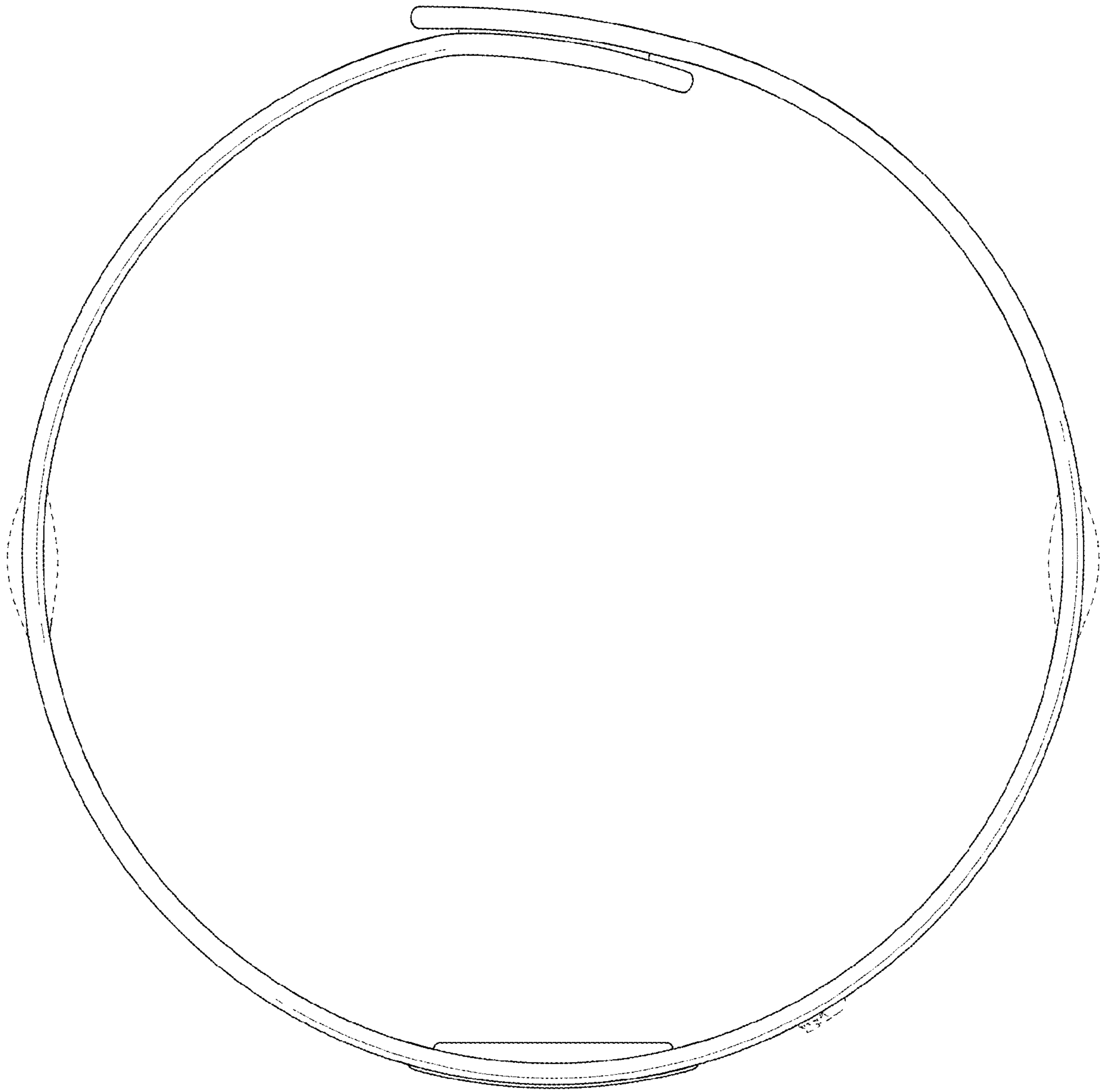

FIG. 7

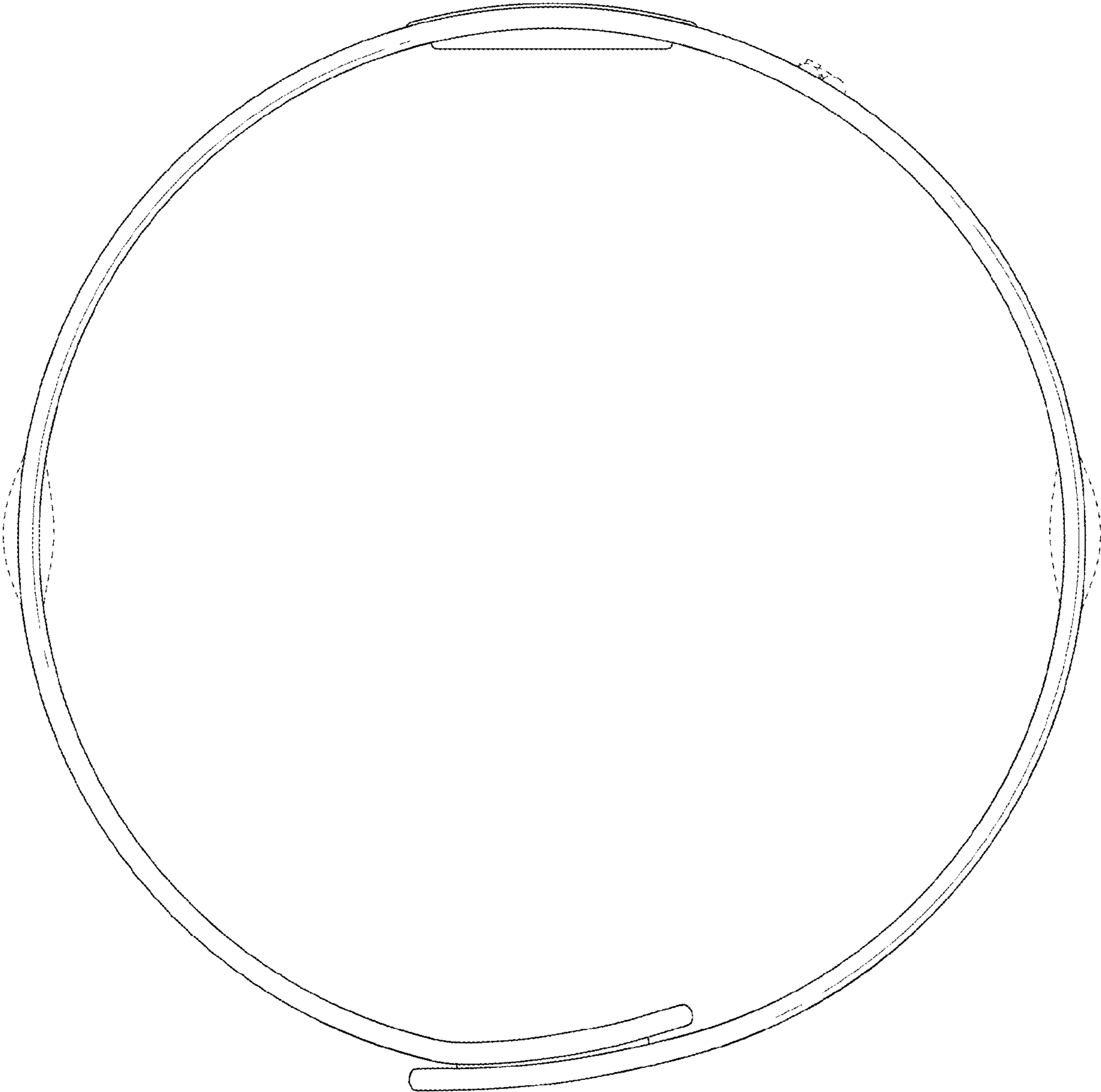

FIG. 8

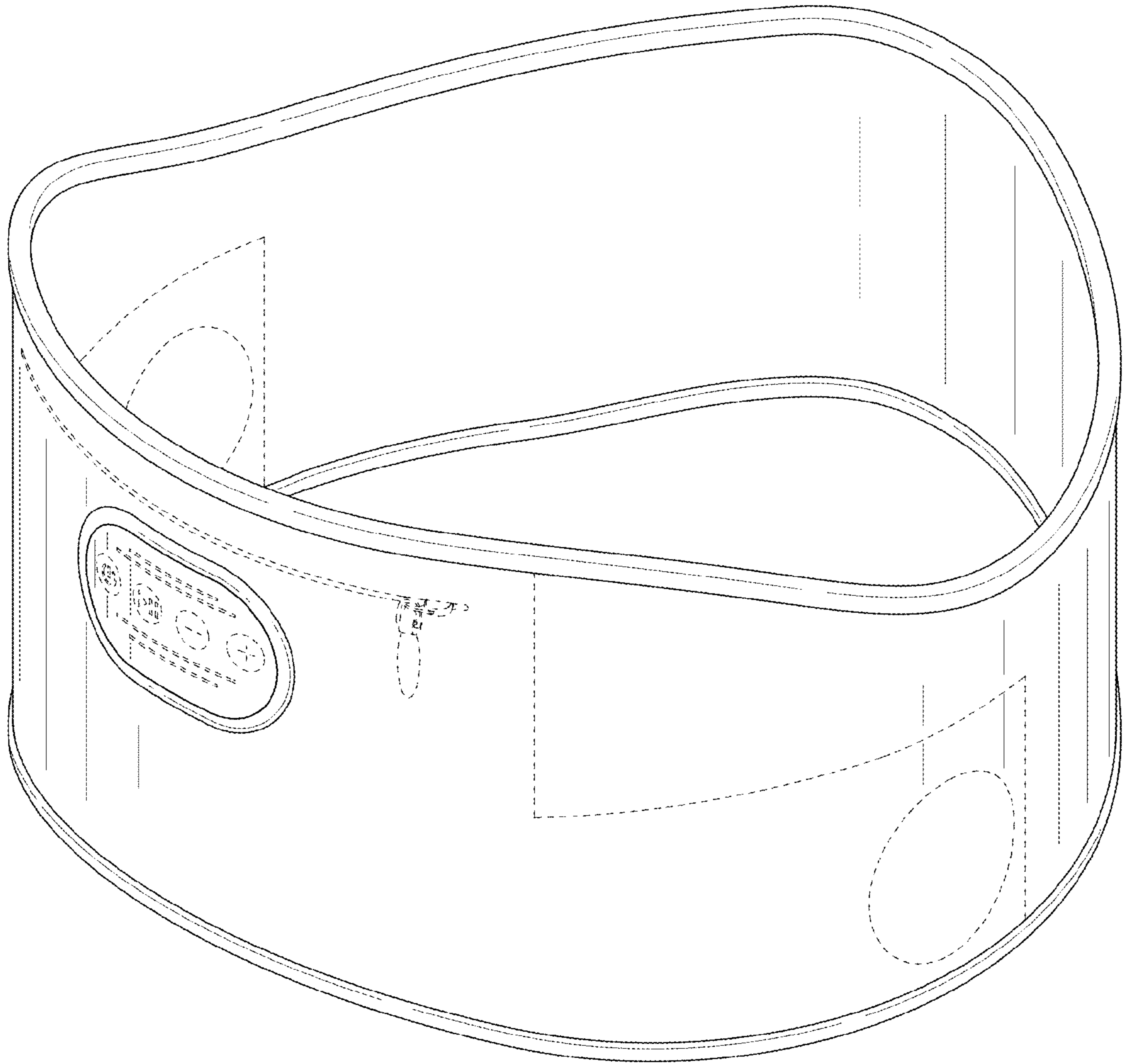

FIG. 9

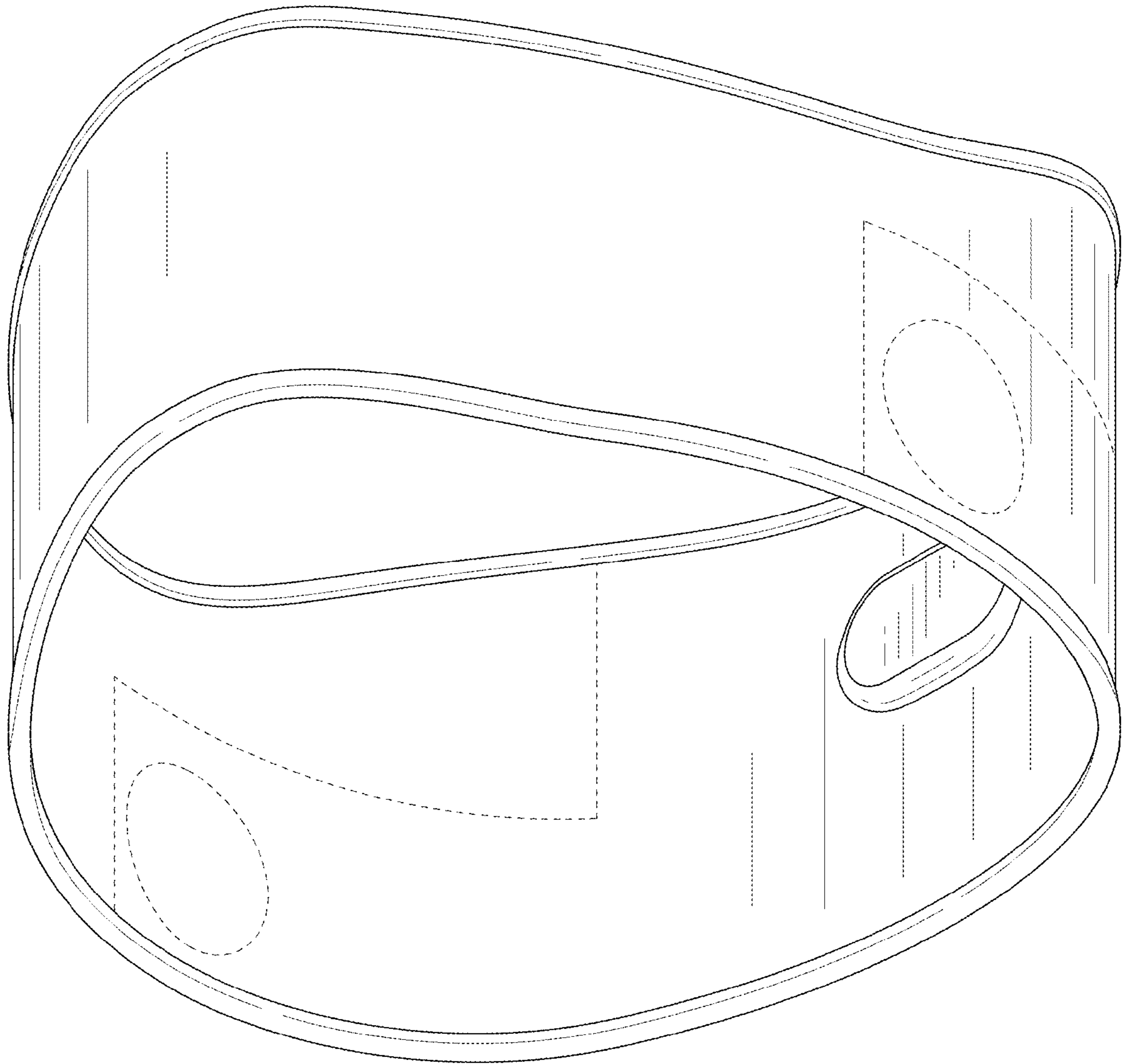

FIG. 10

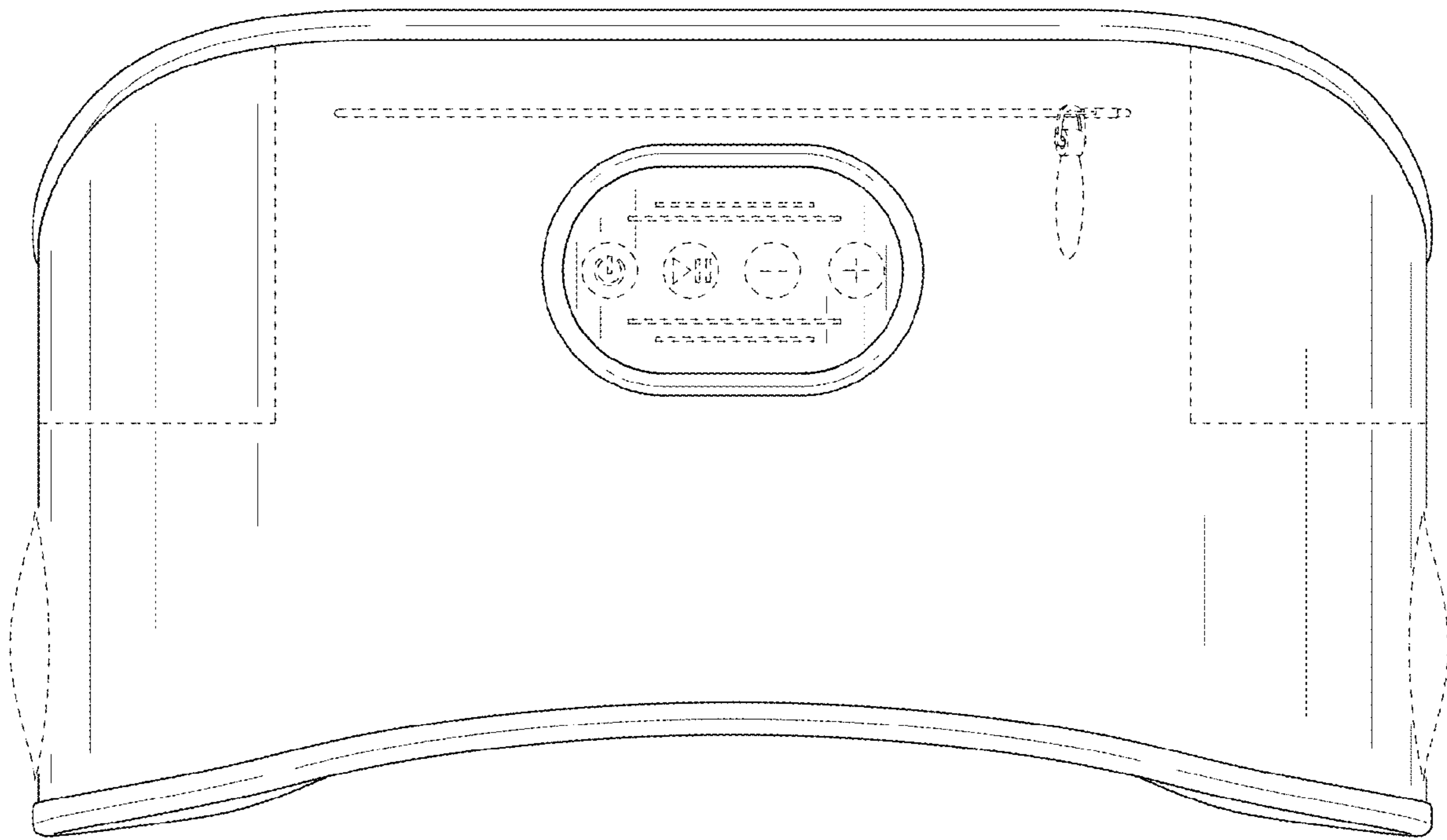

FIG. 11

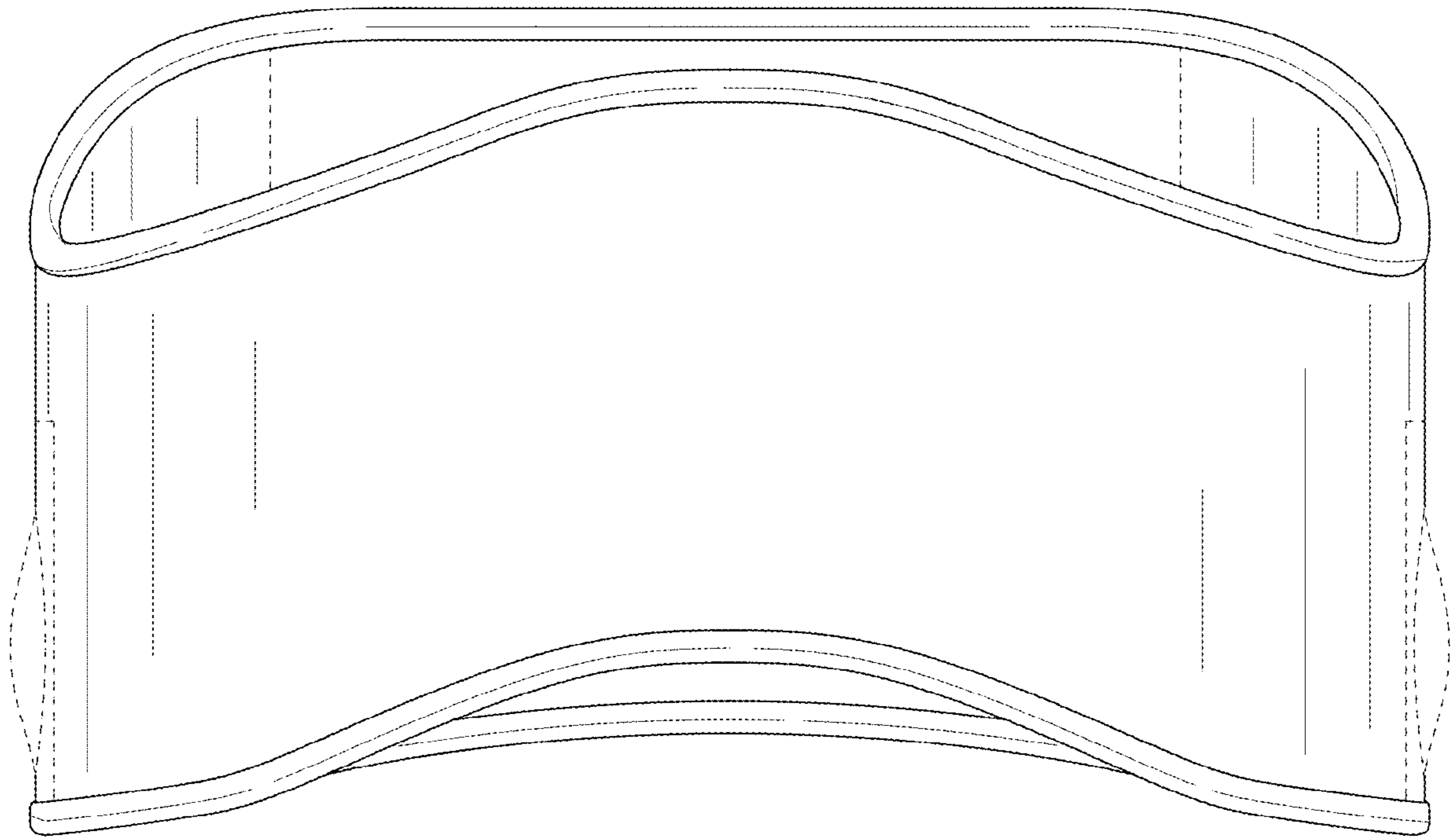

FIG. 12

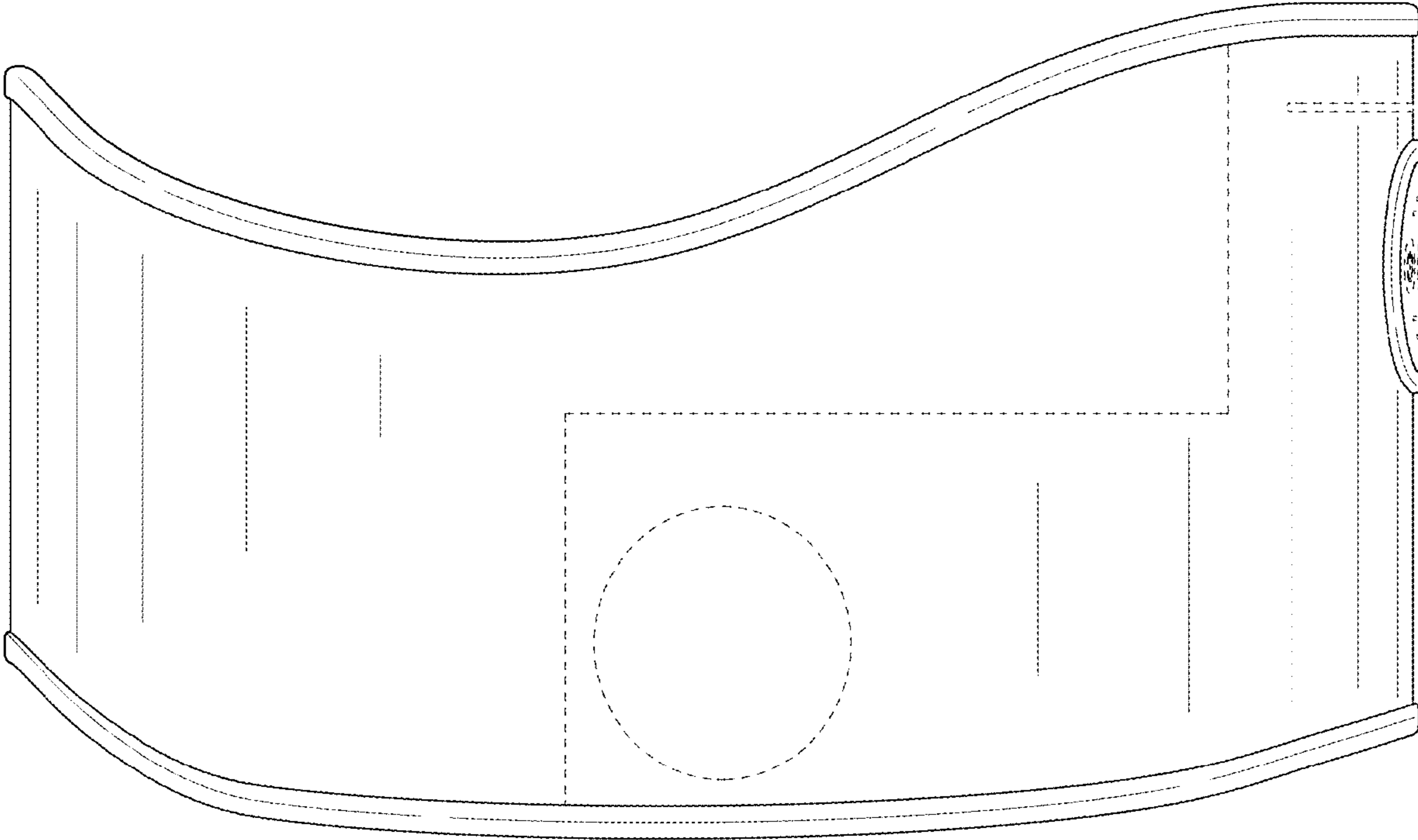

FIG. 13

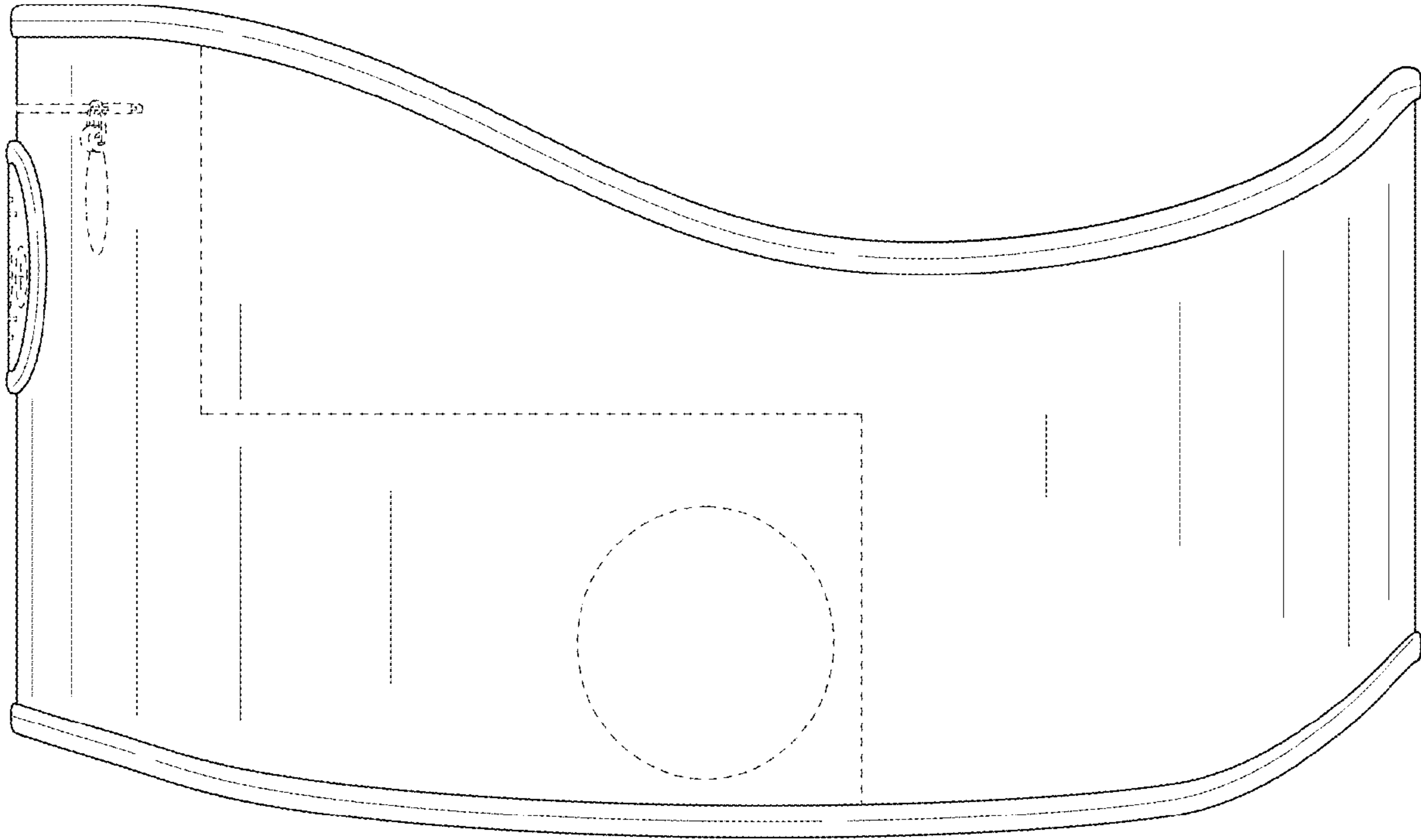

FIG. 14

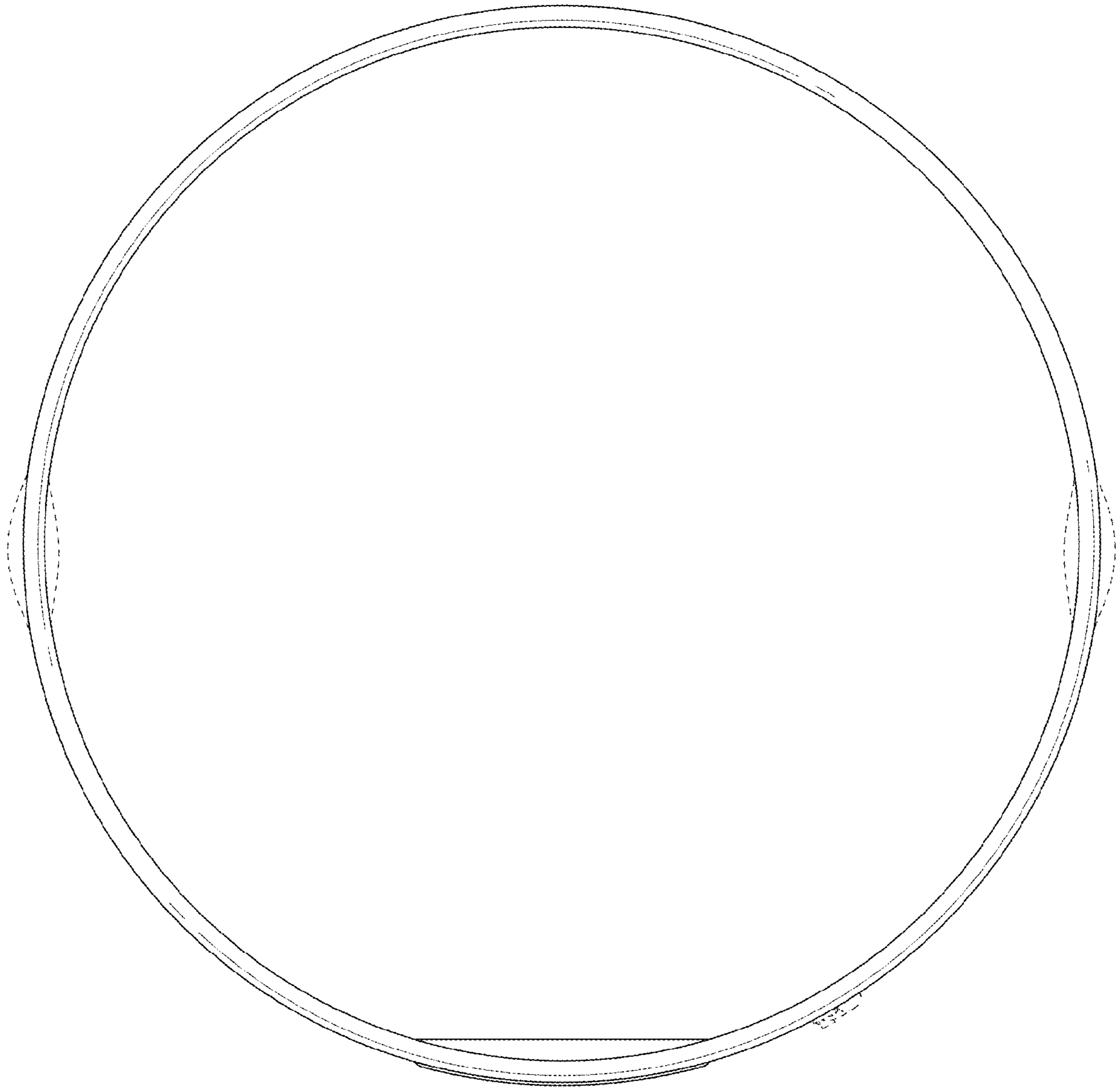

FIG. 15

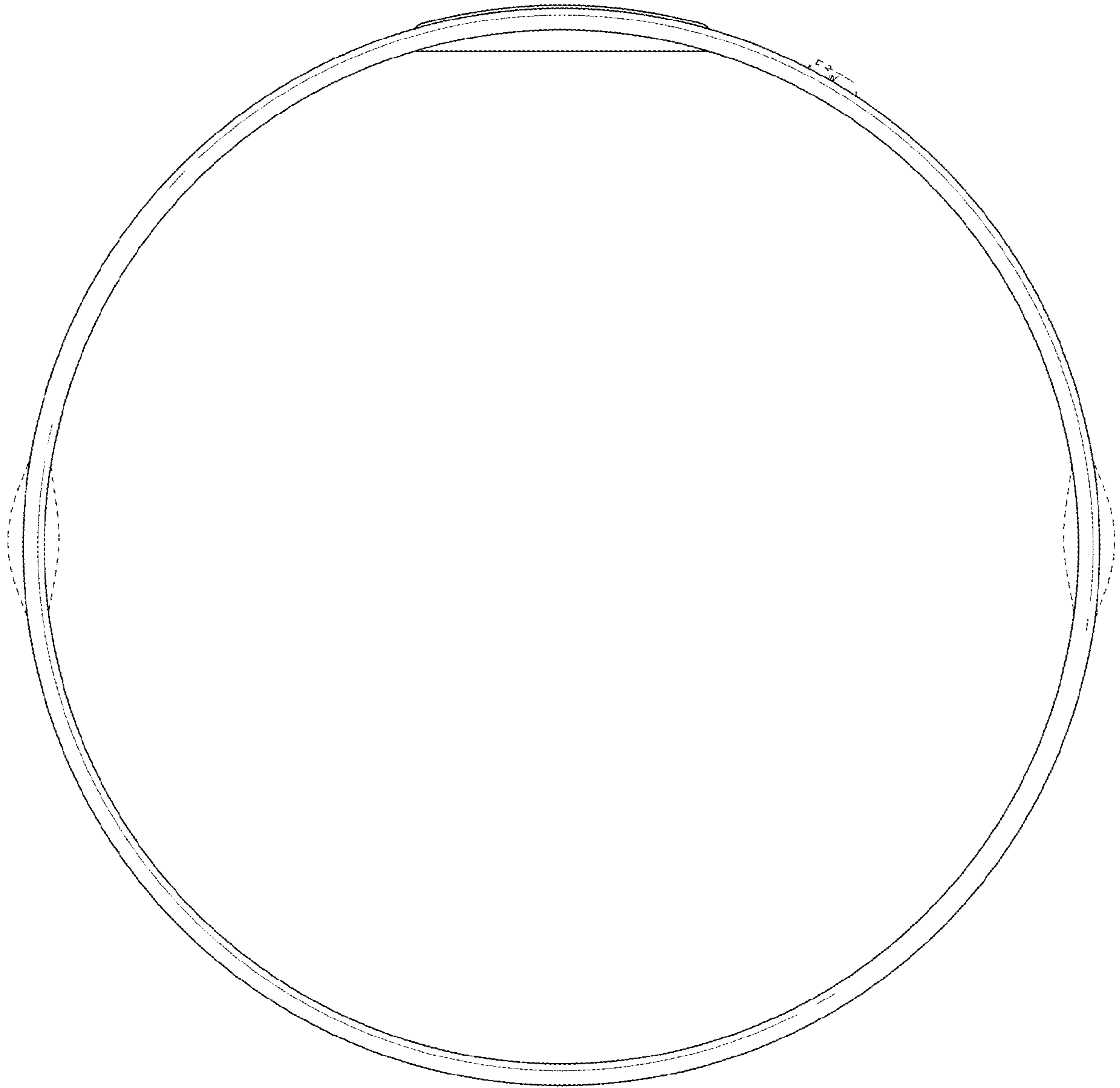

FIG. 16

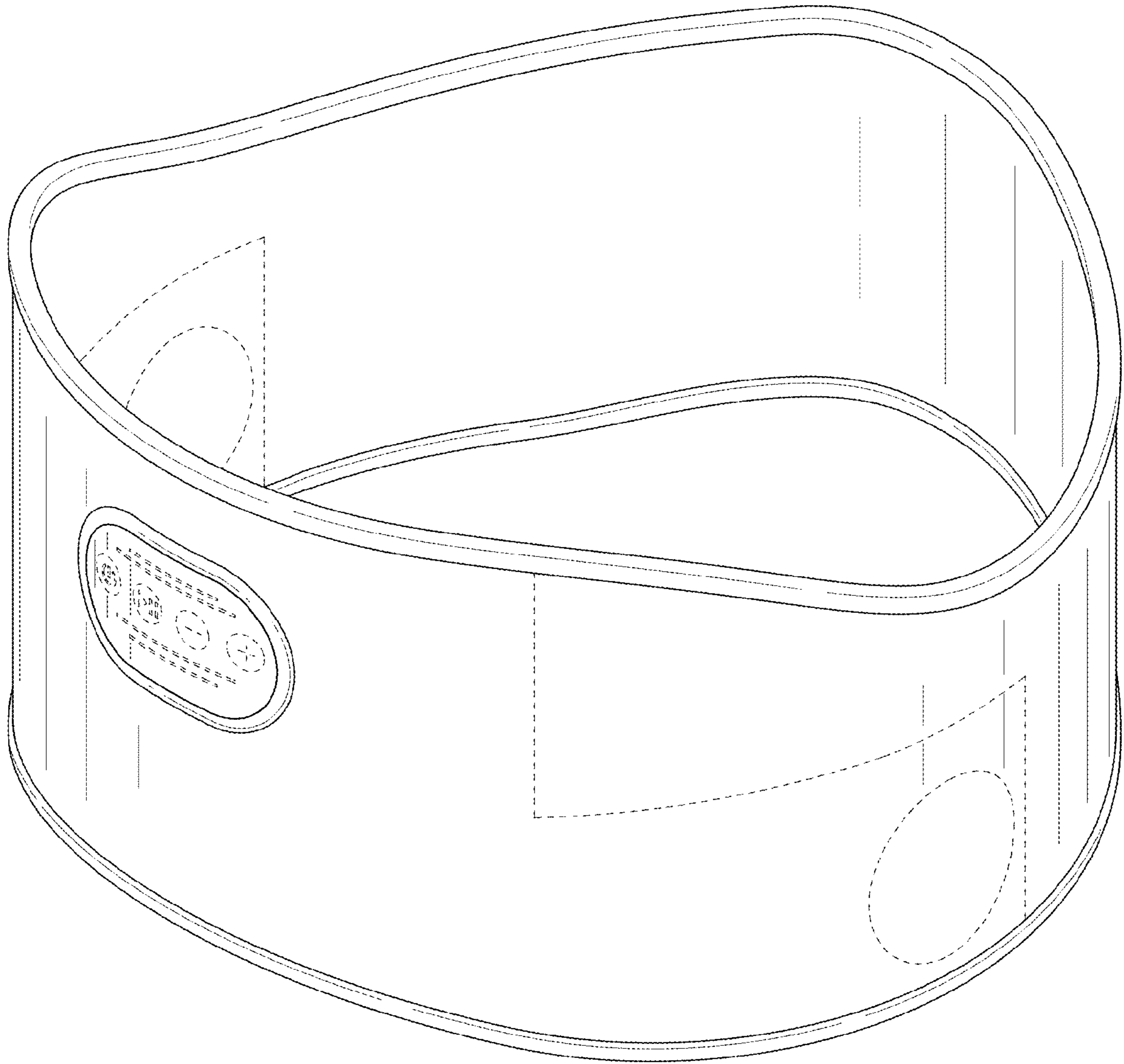

FIG. 17

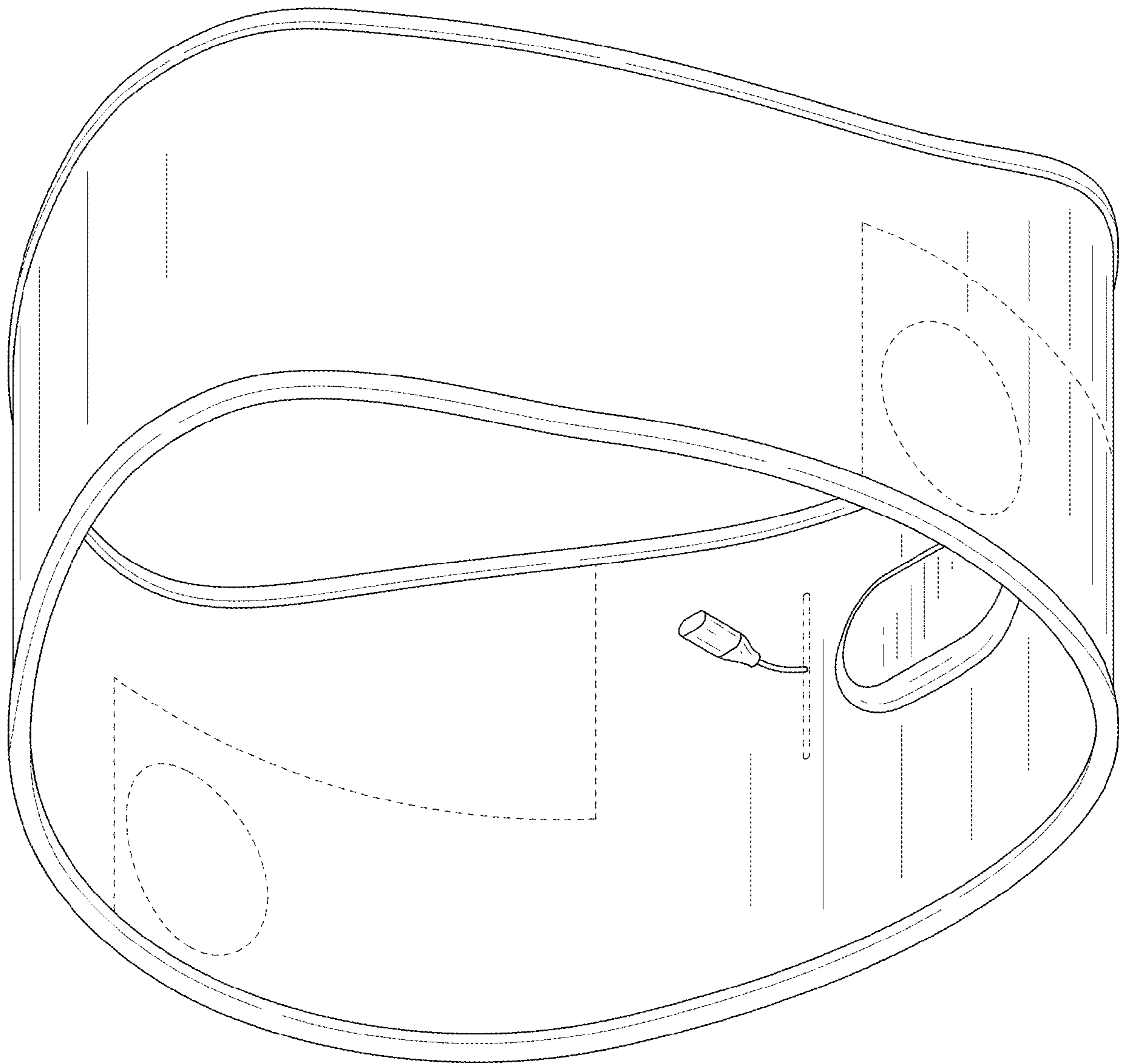

FIG. 18

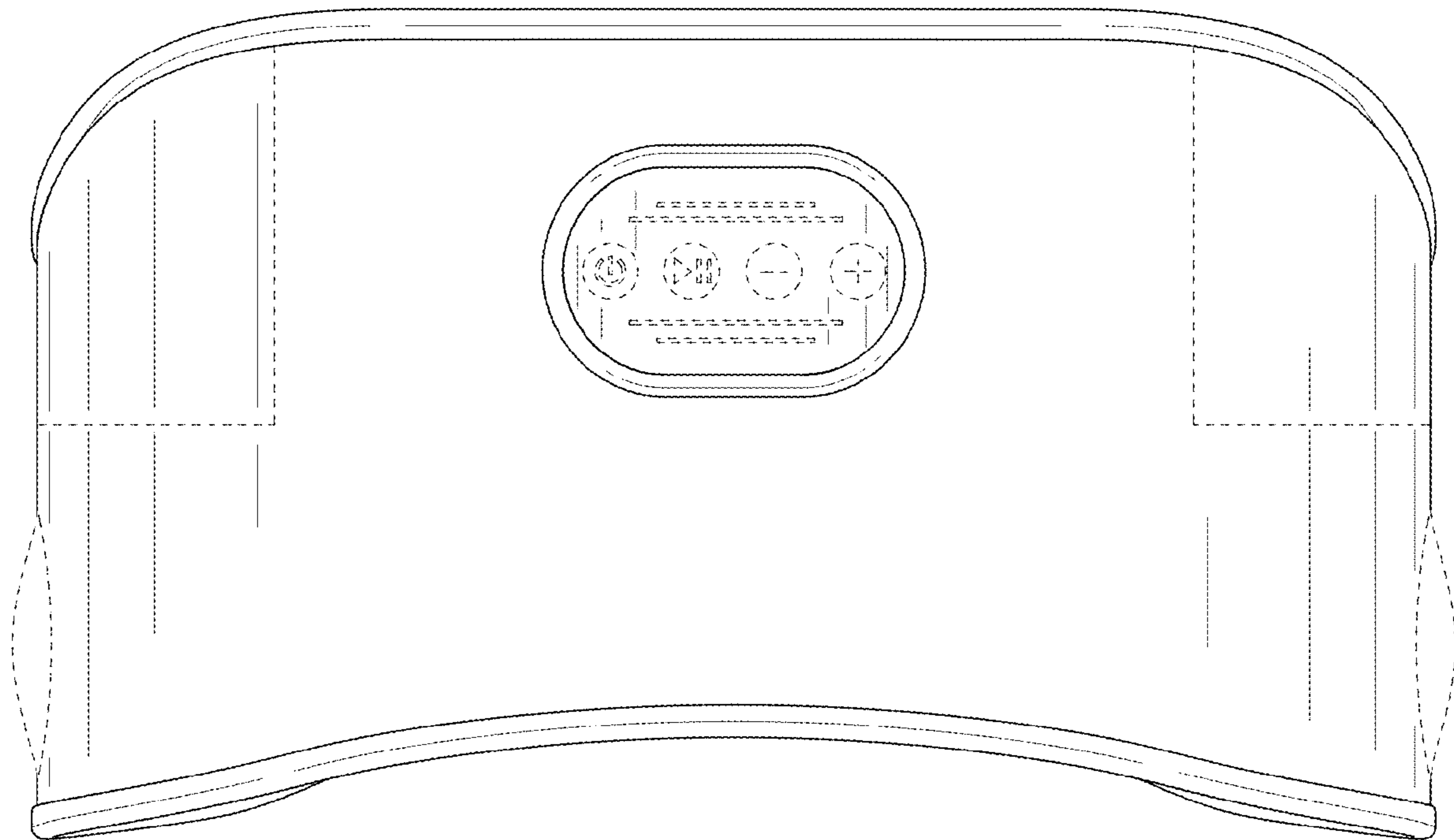

FIG. 19

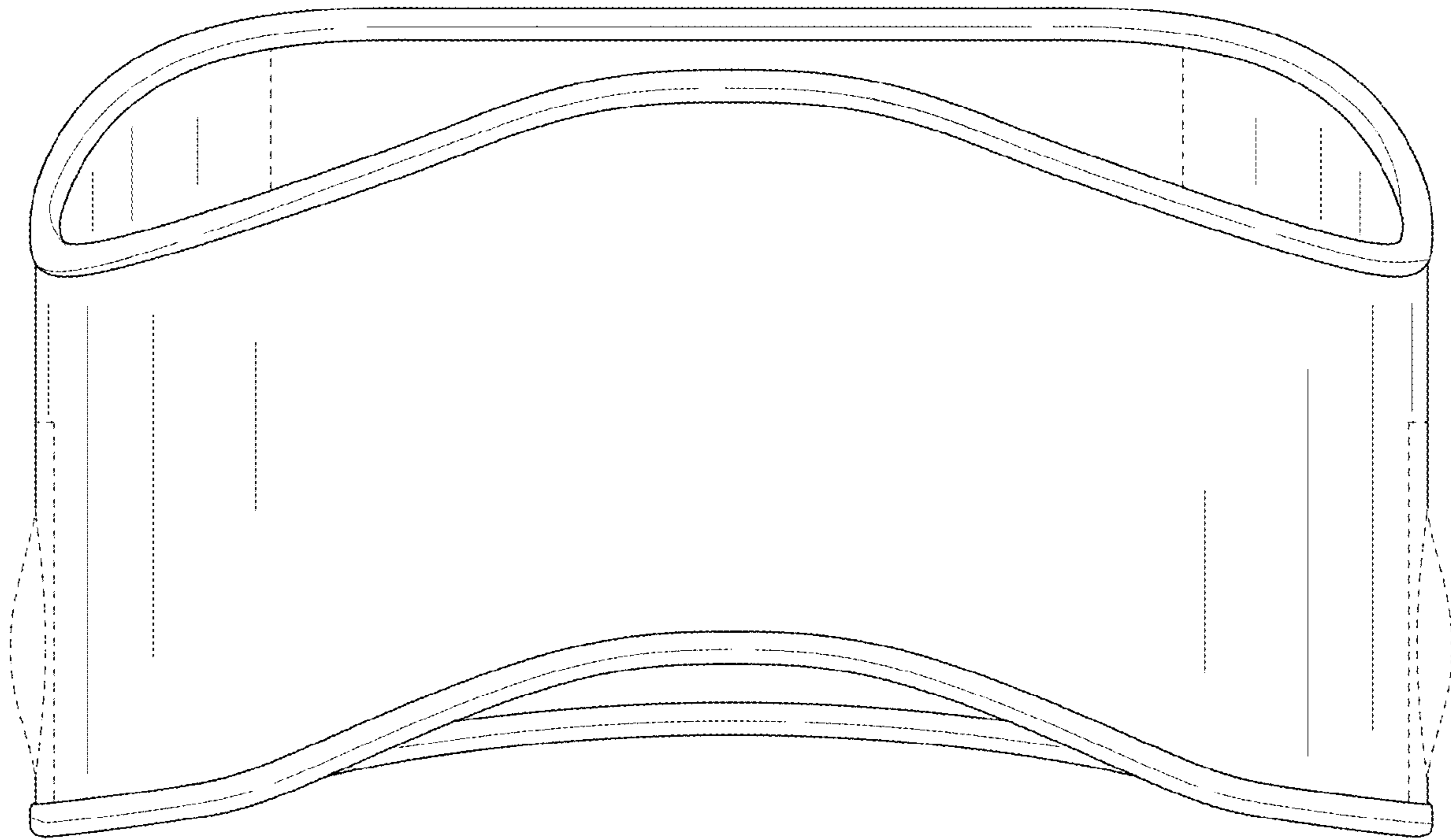

FIG. 20

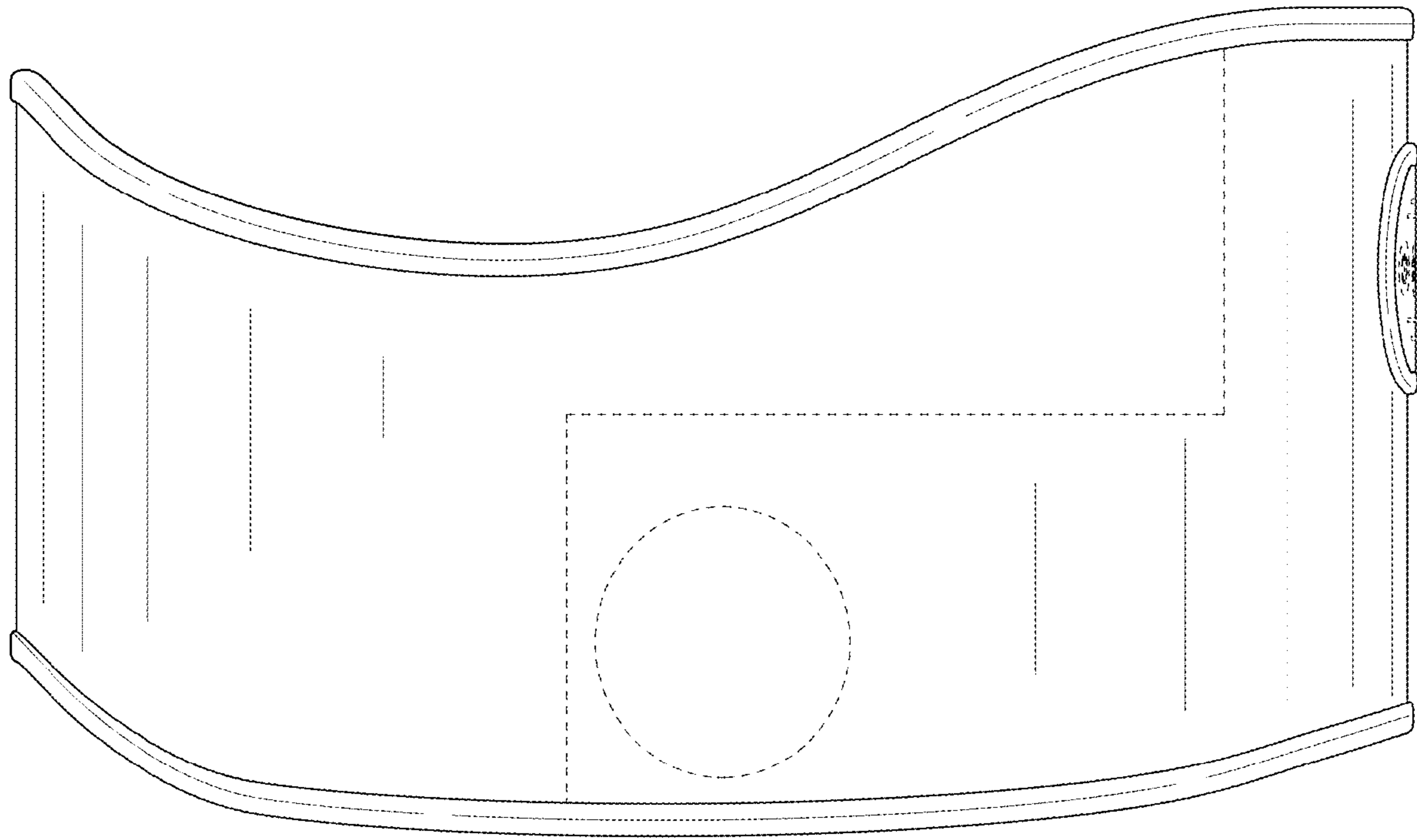

FIG. 21

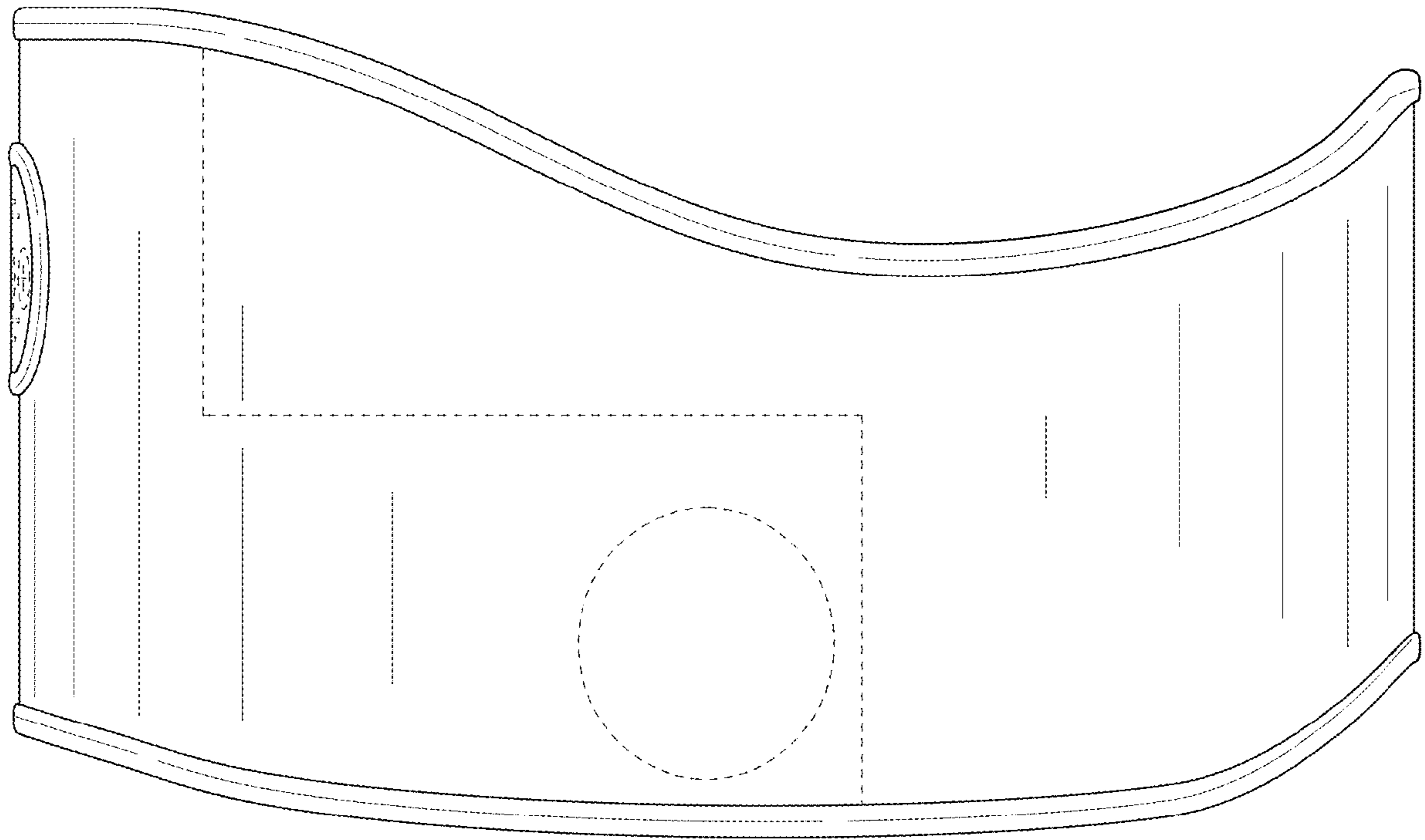

FIG. 22

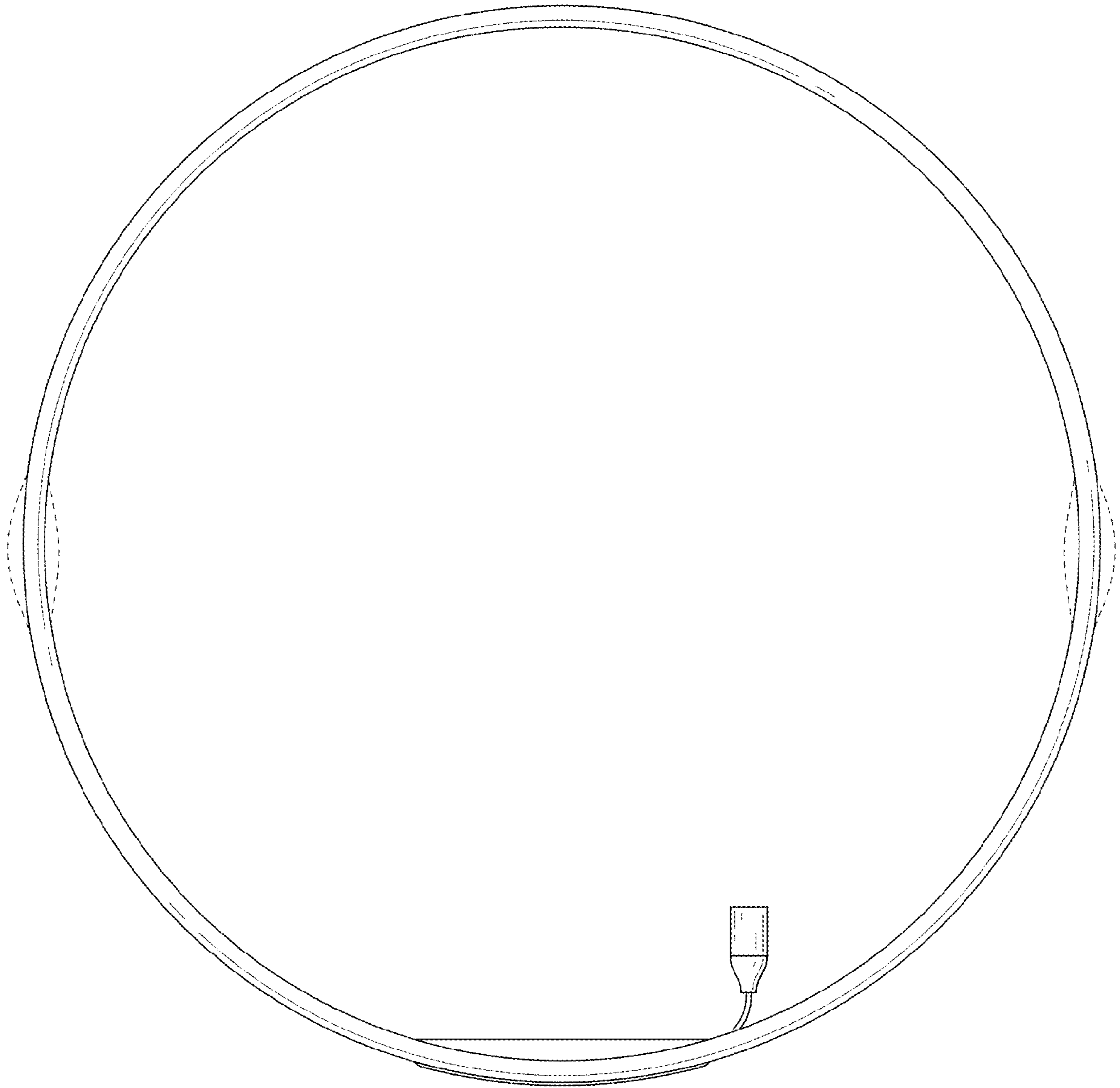

FIG. 23

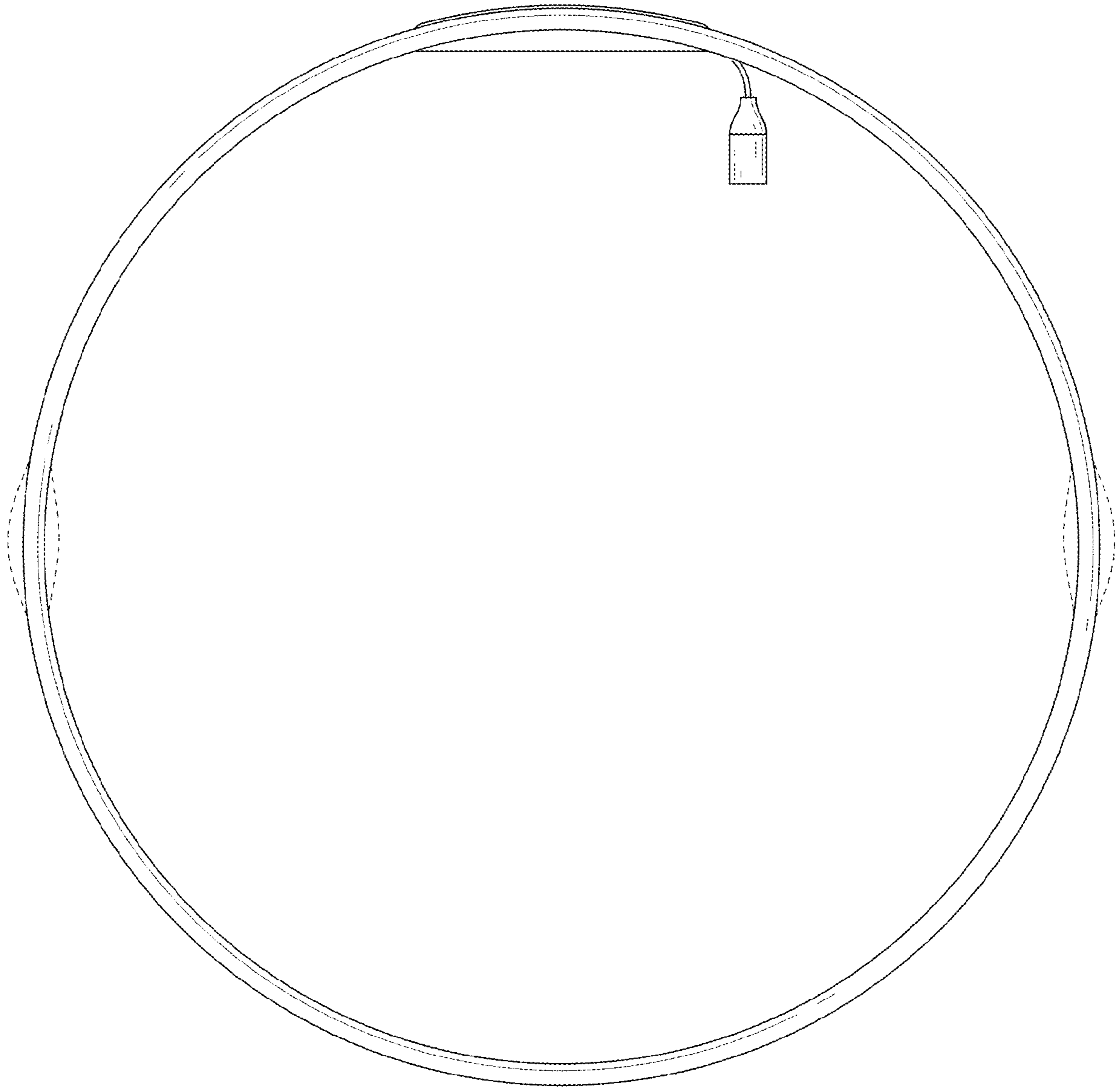

FIG. 24

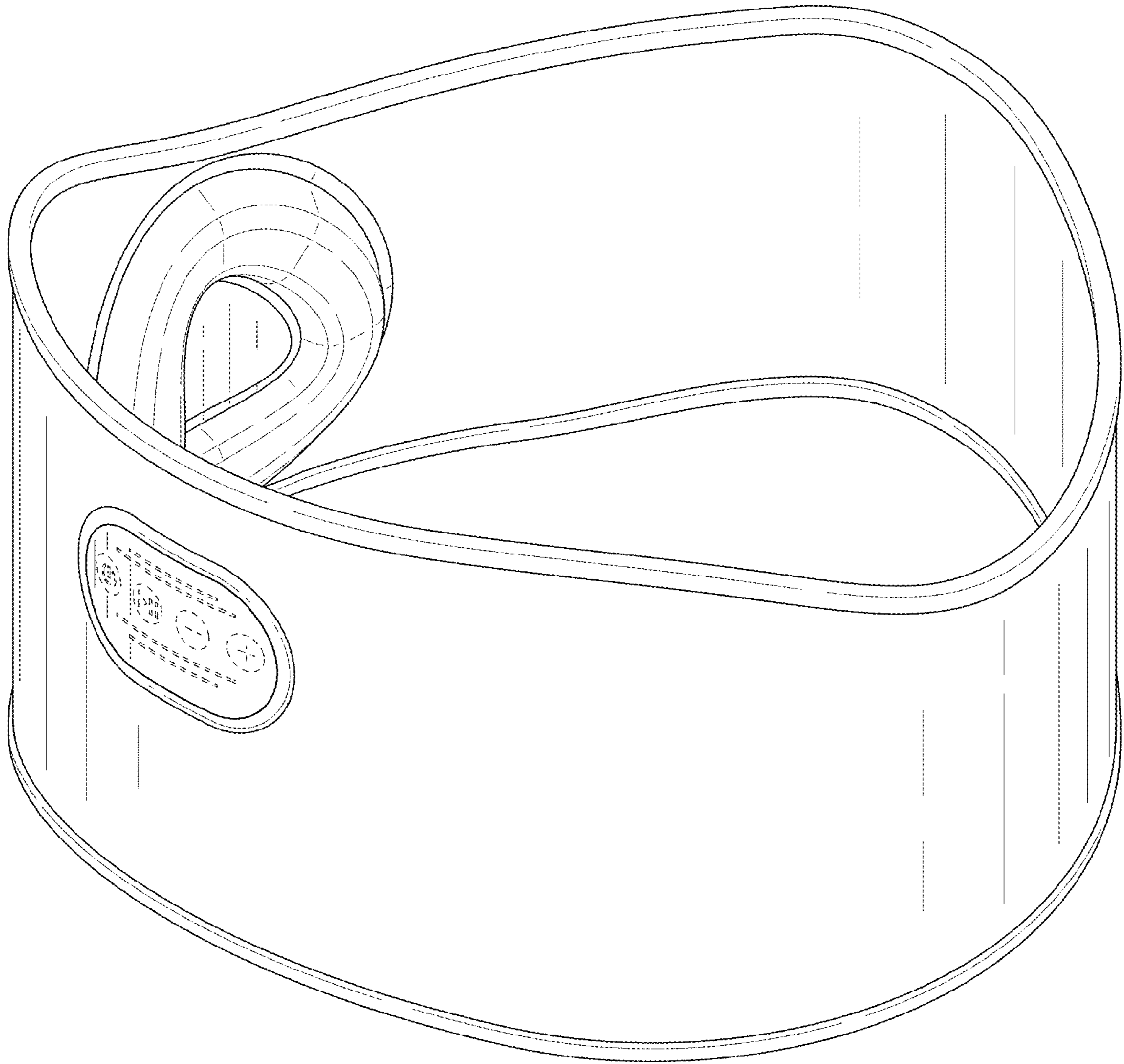

FIG. 25

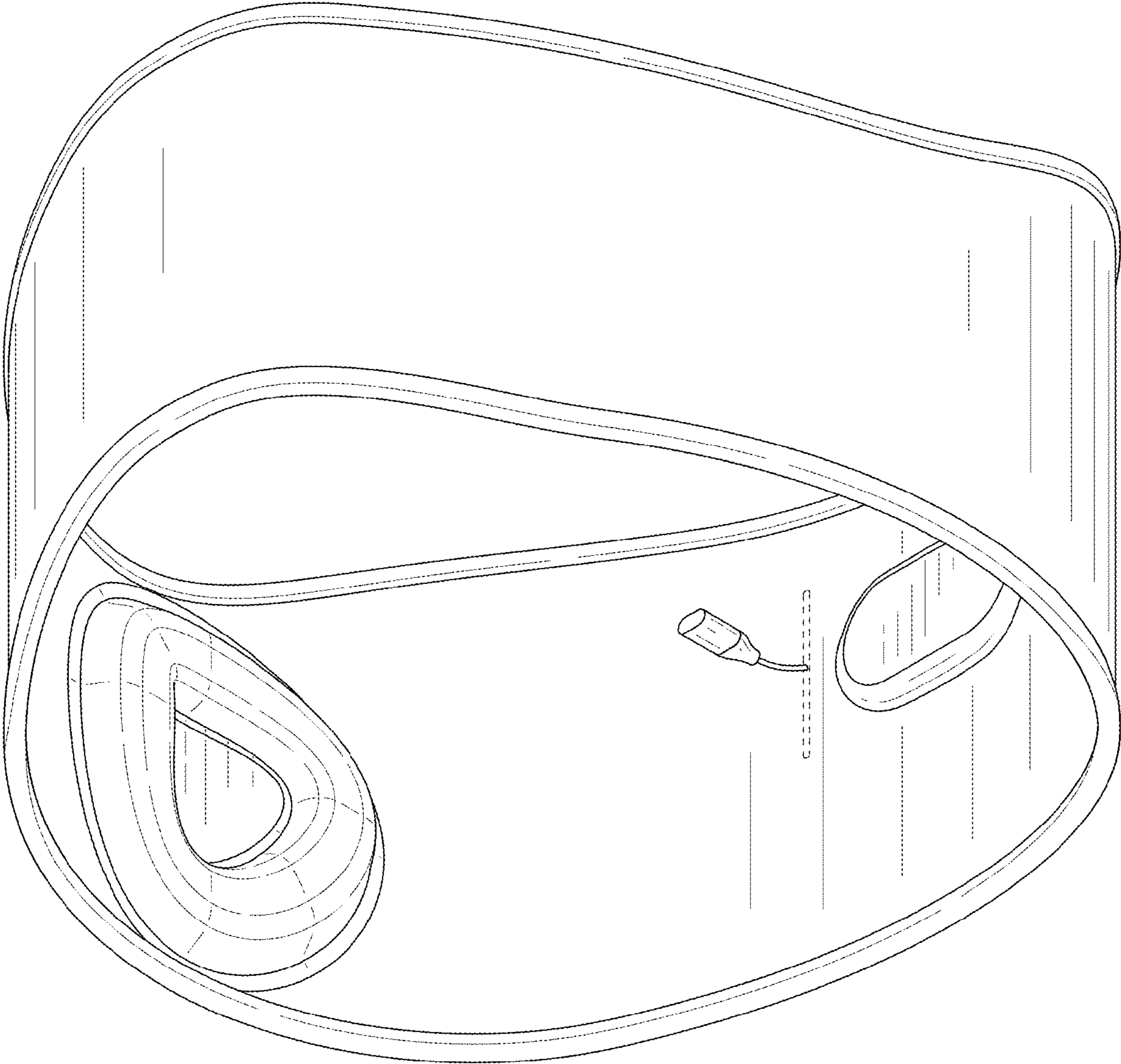

FIG. 26

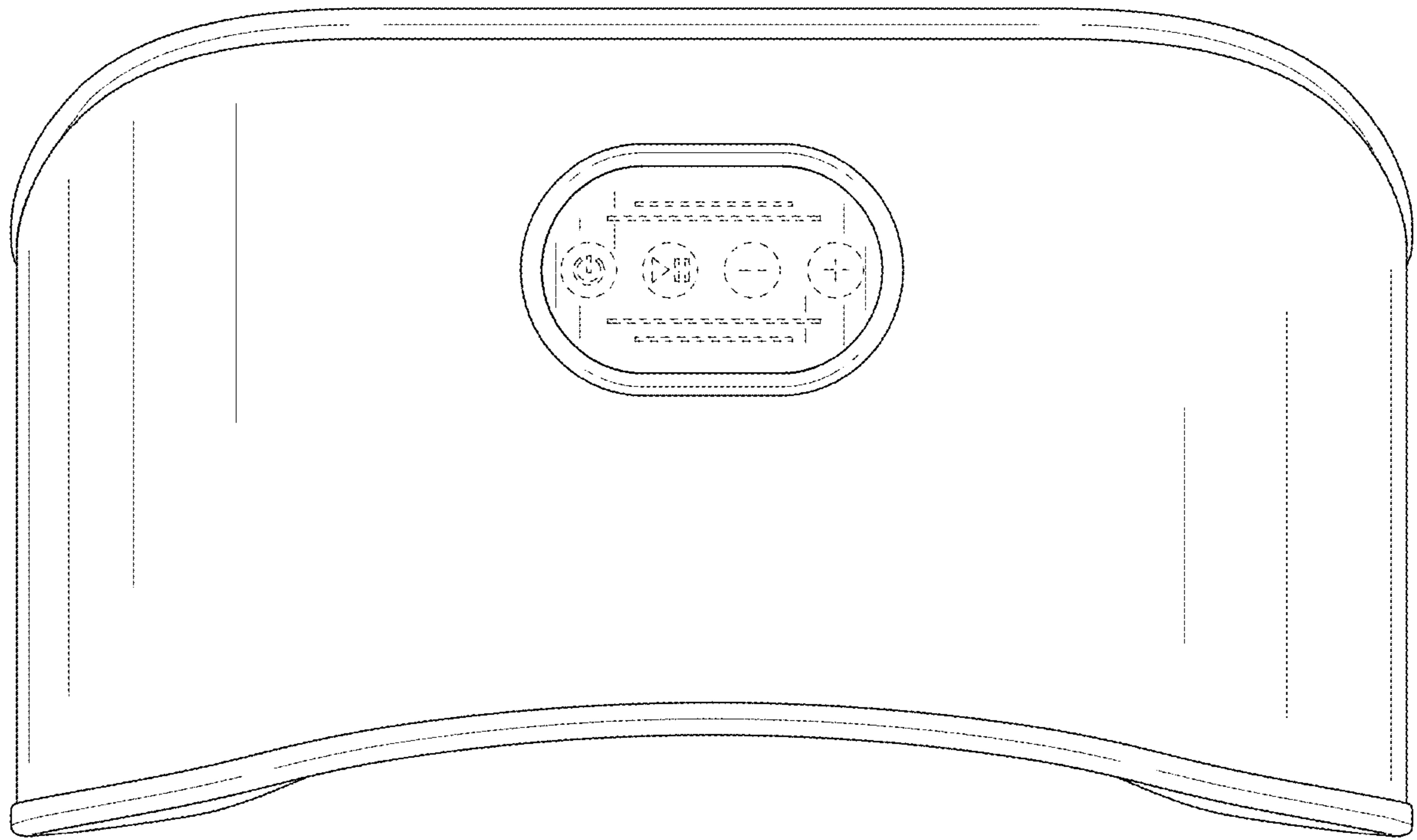

FIG. 27

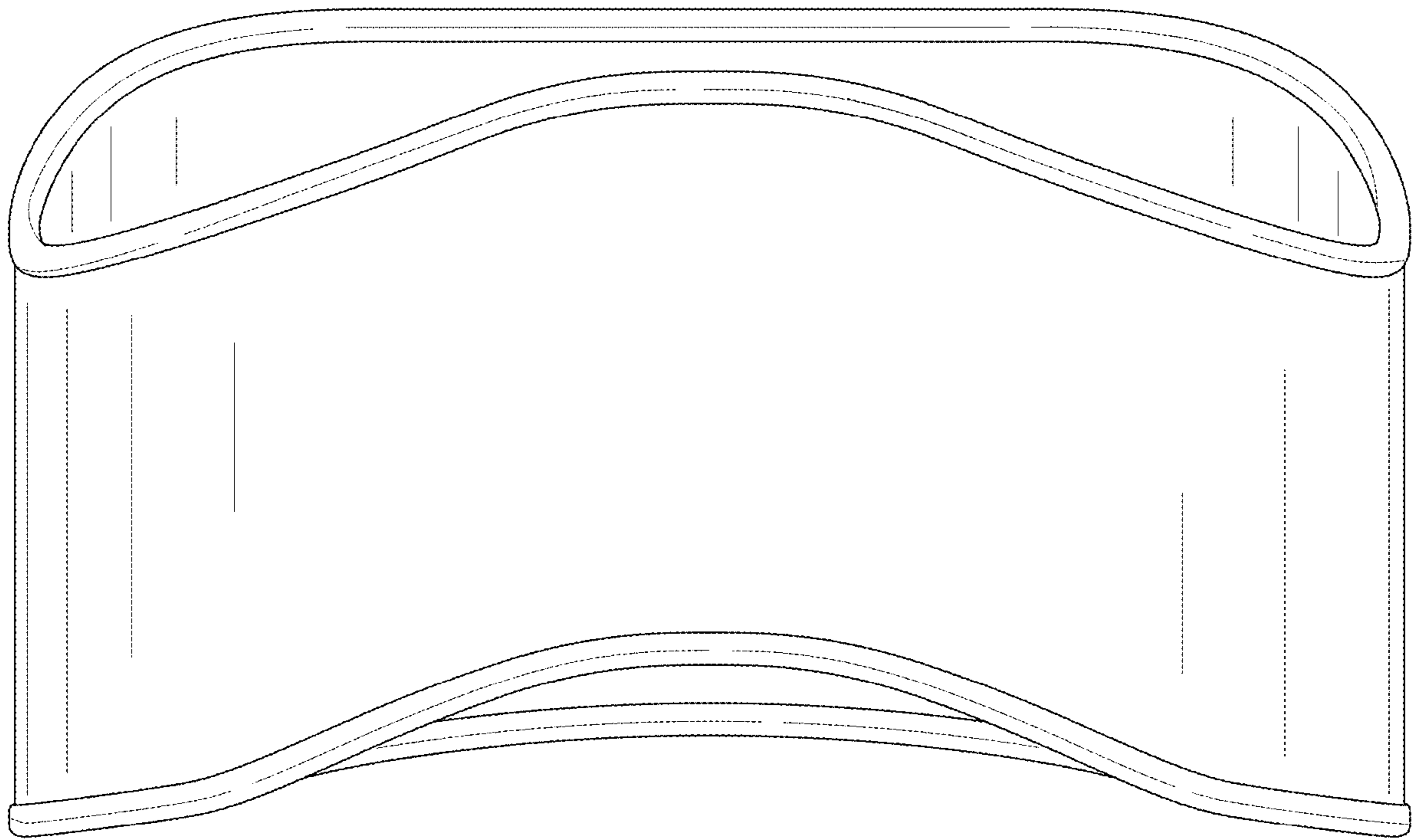

FIG. 28

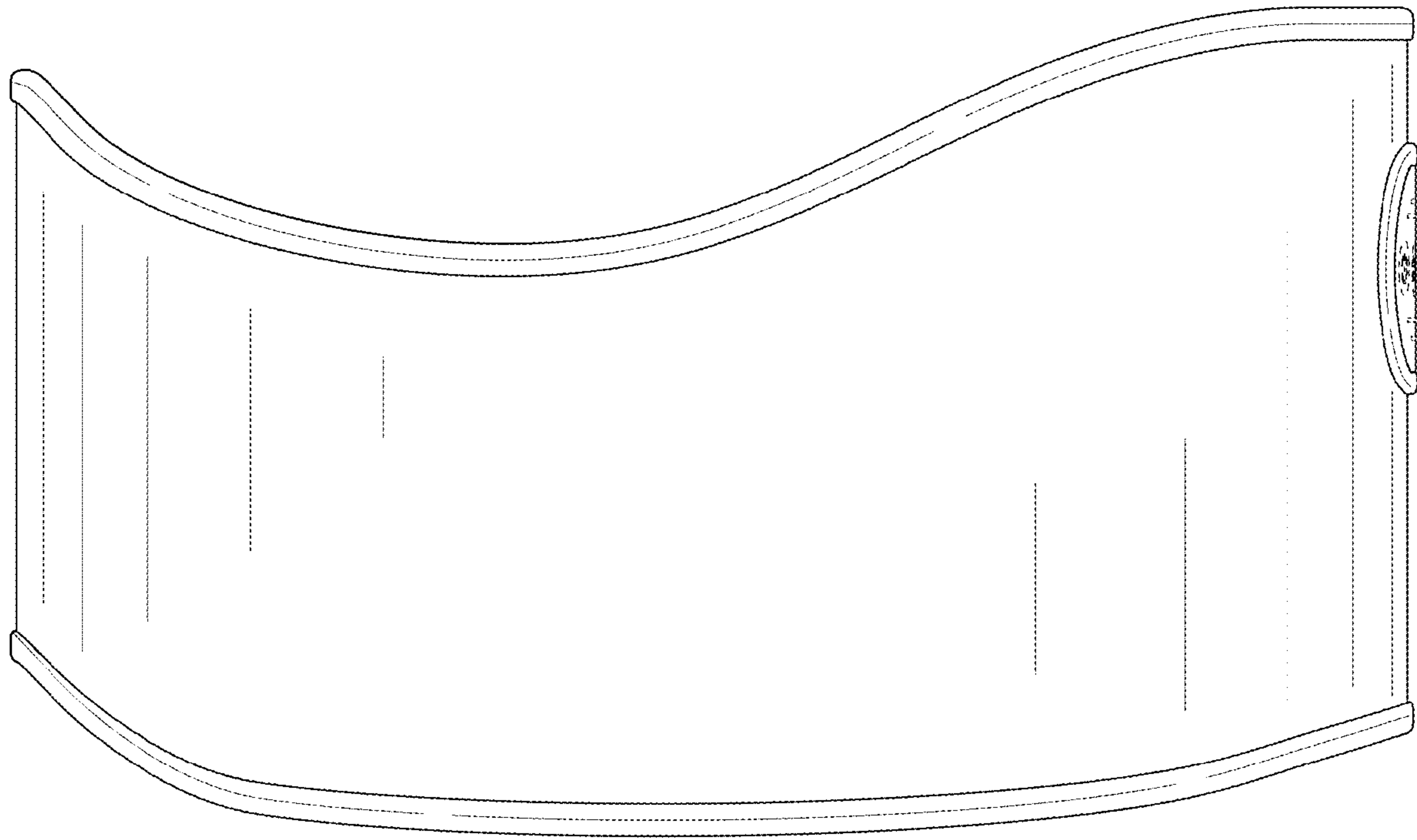

FIG. 29

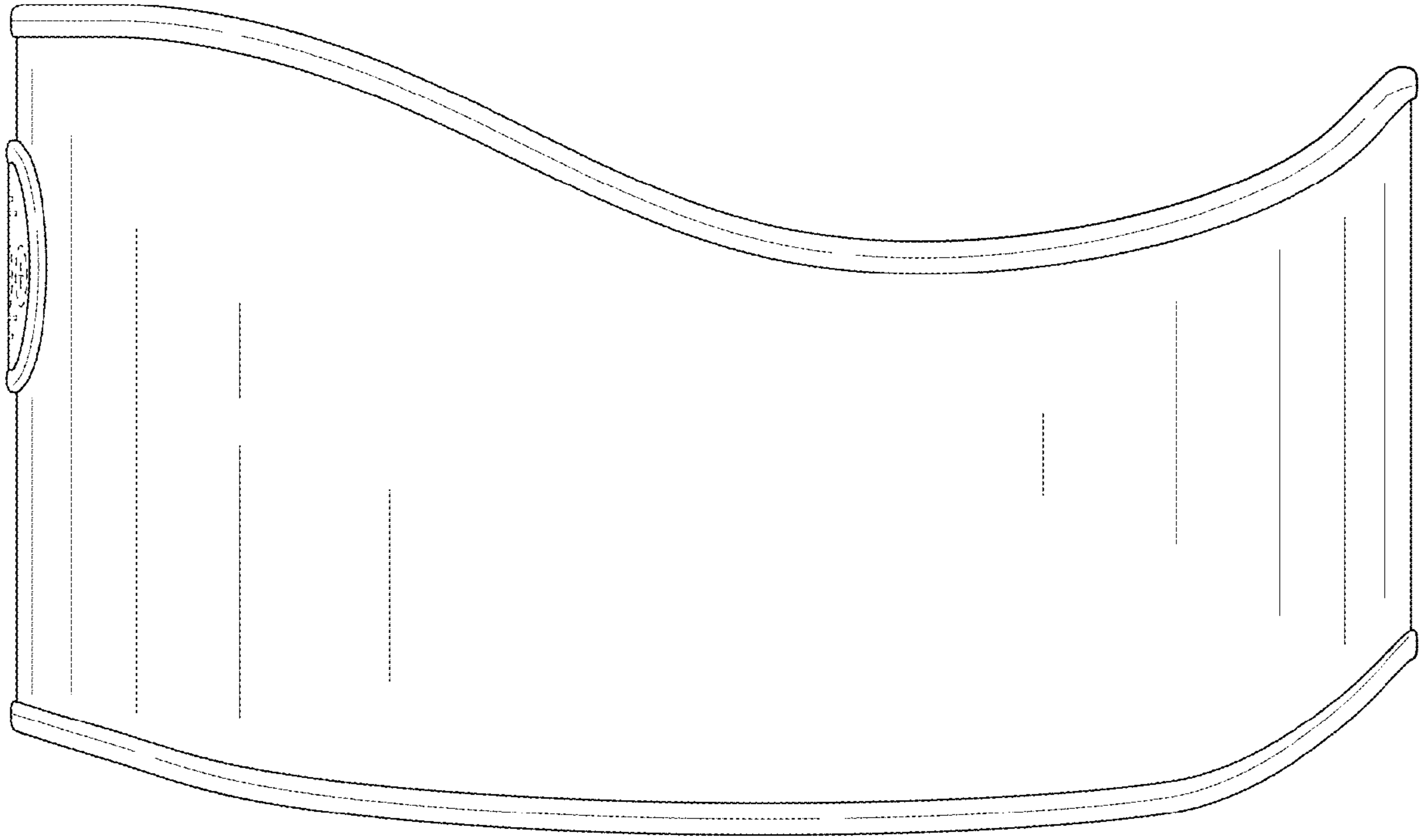

FIG. 30

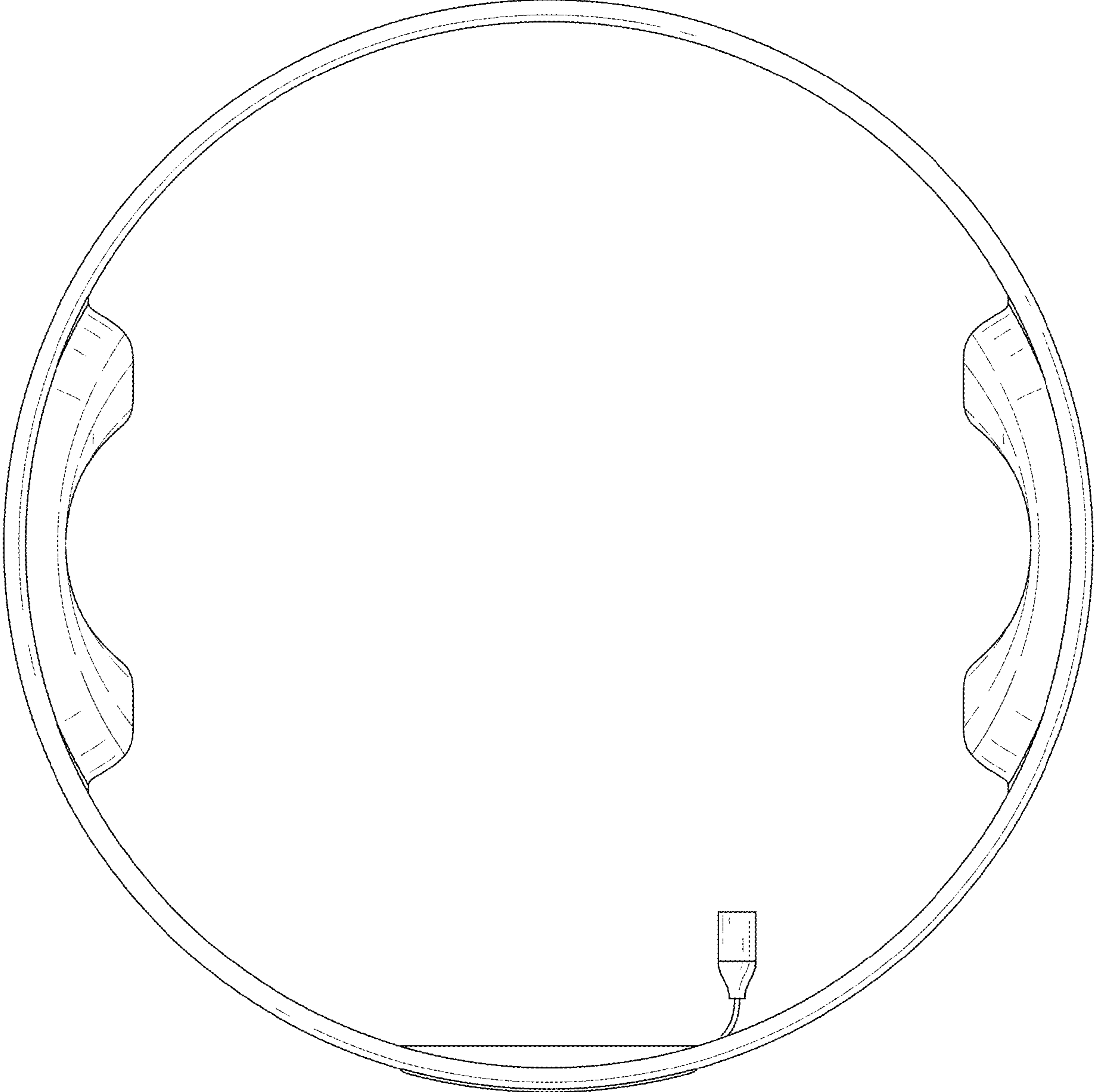

FIG. 31

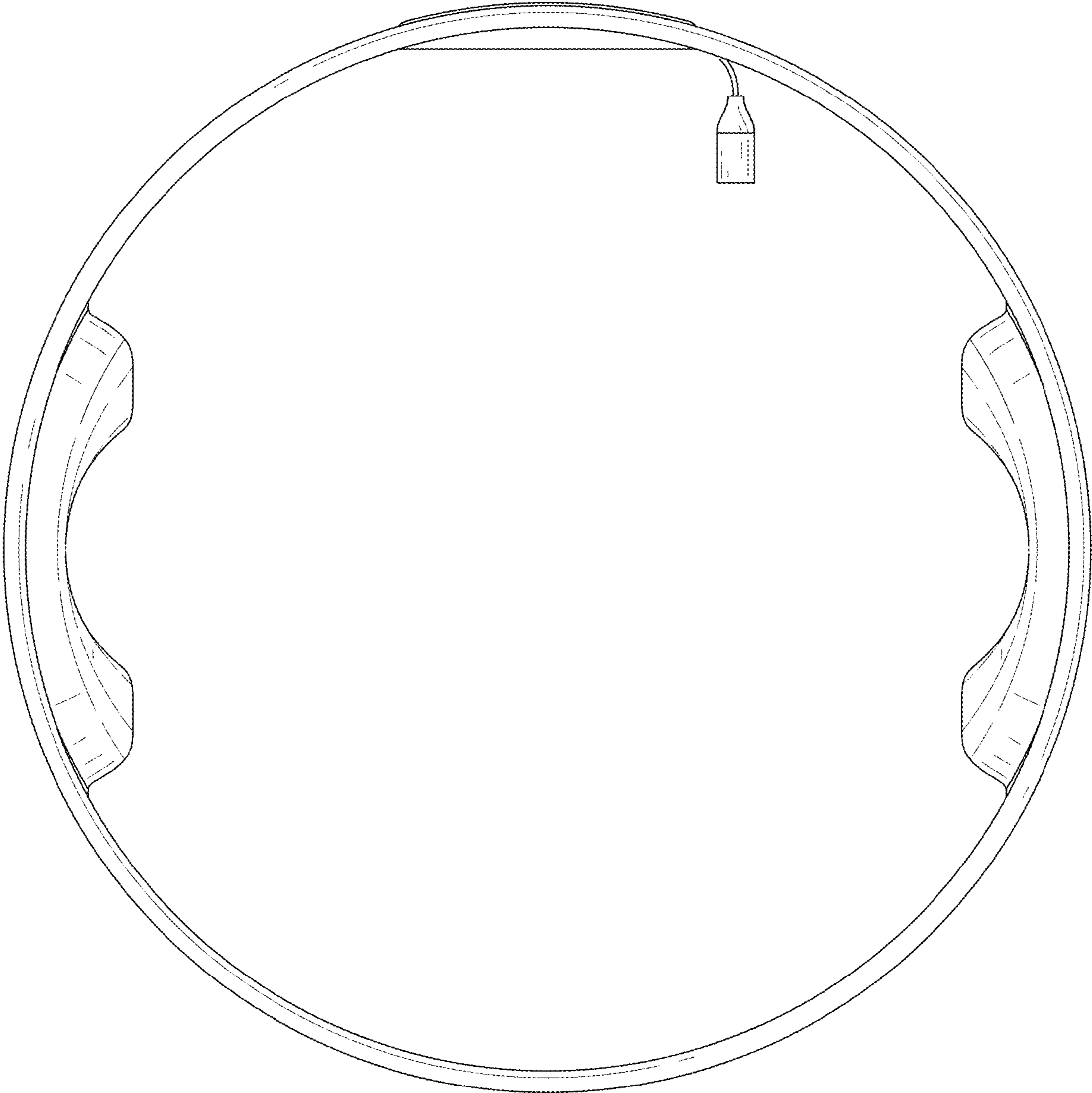

FIG. 32