



US00D965467S

(12) **United States Design Patent**  
**Jin**

(10) **Patent No.:** **US D965,467 S**

(45) **Date of Patent:** **\*\* Oct. 4, 2022**

(54) **LED POT**

(71) Applicant: **Xuebing Jin**, Zhejiang (CN)

(72) Inventor: **Xuebing Jin**, Zhejiang (CN)

(\*\*) Term: **15 Years**

(21) Appl. No.: **29/817,480**

(22) Filed: **Dec. 1, 2021**

(51) **LOC (13) Cl.** ..... **11-02**

(52) **U.S. Cl.**  
USPC ..... **D11/144; D11/152**

(58) **Field of Classification Search**  
USPC ..... D11/143, 144, 148, 152, 153, 164;  
D7/354, 554.2  
CPC ..... A01G 9/00; A01G 9/02; A01G 9/021  
See application file for complete search history.

(56) **References Cited**

**U.S. PATENT DOCUMENTS**

D230,760 S *	3/1974	Wilkinson	.....	D11/152
3,949,524 A *	4/1976	Mickelson	.....	A01G 9/02 47/79
D364,112 S *	11/1995	Dickinson	.....	D11/152
D395,411 S *	6/1998	Grebert	.....	D11/143
D441,315 S	5/2001	Huffman		
D442,422 S *	5/2001	Dabney	.....	D11/152
D704,592 S *	5/2014	Hung	.....	D11/152

D713,757 S *	9/2014	Thuma	.....	D11/152
D739,781 S *	9/2015	Pettigrew	.....	D11/152
D739,782 S *	9/2015	Pettigrew	.....	D11/152
D779,897 S *	2/2017	Thuma	.....	D11/143
D813,719 S *	3/2018	Keeble	.....	D11/143
D827,486 S *	9/2018	Quinlan	.....	D11/143
D919,219 S *	5/2021	Greenspon	.....	D34/1

\* cited by examiner

*Primary Examiner* — S. Bryan Reinholdt, Jr.

(57) **CLAIM**

The ornamental design for the LED pot, as shown and described.

**DESCRIPTION**

FIG. 1 is a front, bottom perspective view of a LED pot design showing my new design.  
 FIG. 2 is a front view of the LED pot.  
 FIG. 3 is a rear view of the LED pot.  
 FIG. 4 is a left side view of the LED pot.  
 FIG. 5 is a right side view of the LED pot.  
 FIG. 6 is a top view of the LED pot.  
 FIG. 7 is a bottom view of the LED pot.  
 FIG. 8 is a top perspective view of the LED pot; and,  
 FIG. 9 is an exploded front view of the LED pot.  
 The shading in the drawings does not depict surface ornamentation but illustrates the surface contours of the LED pot claimed design.

**1 Claim, 9 Drawing Sheets**

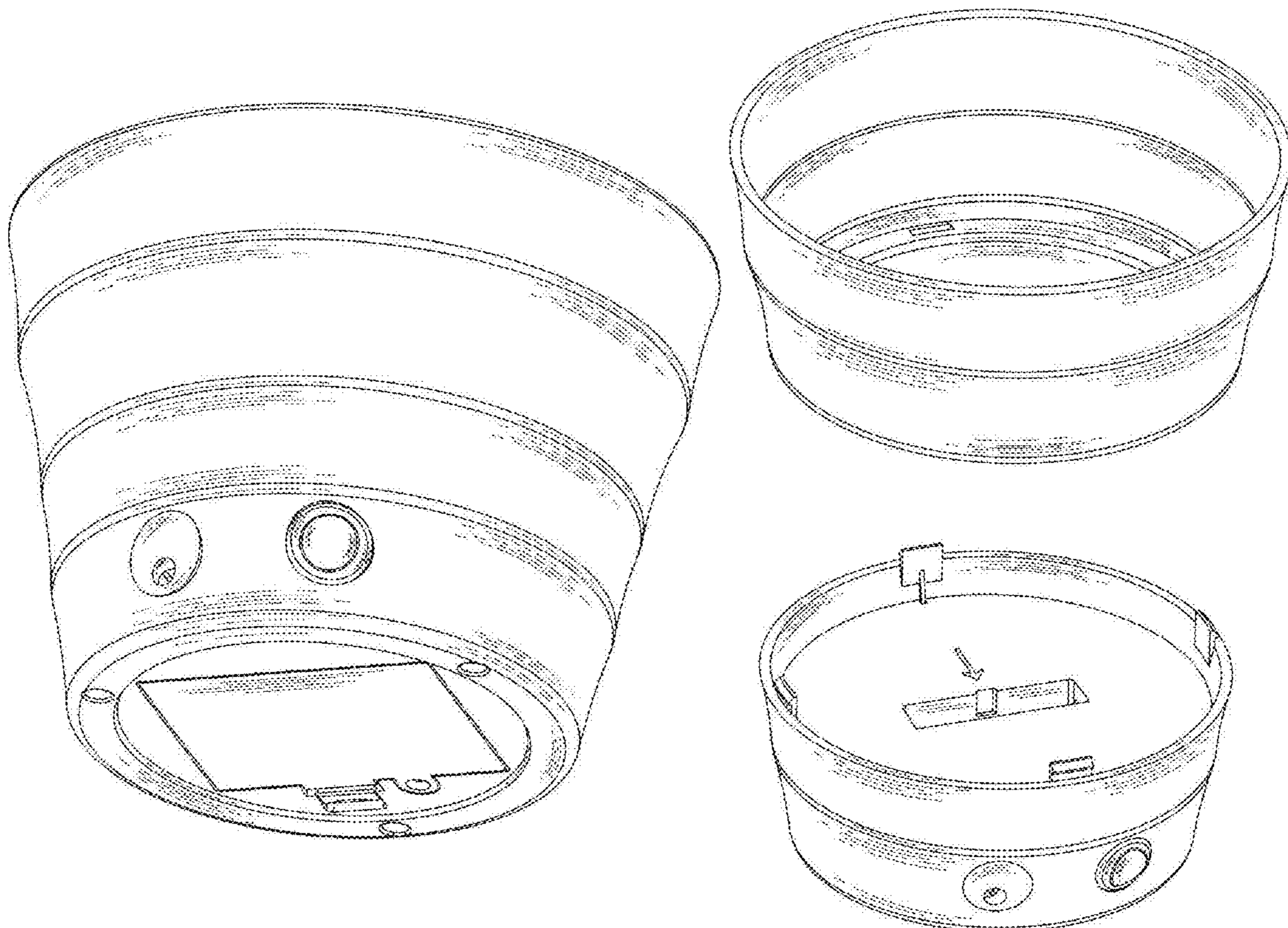

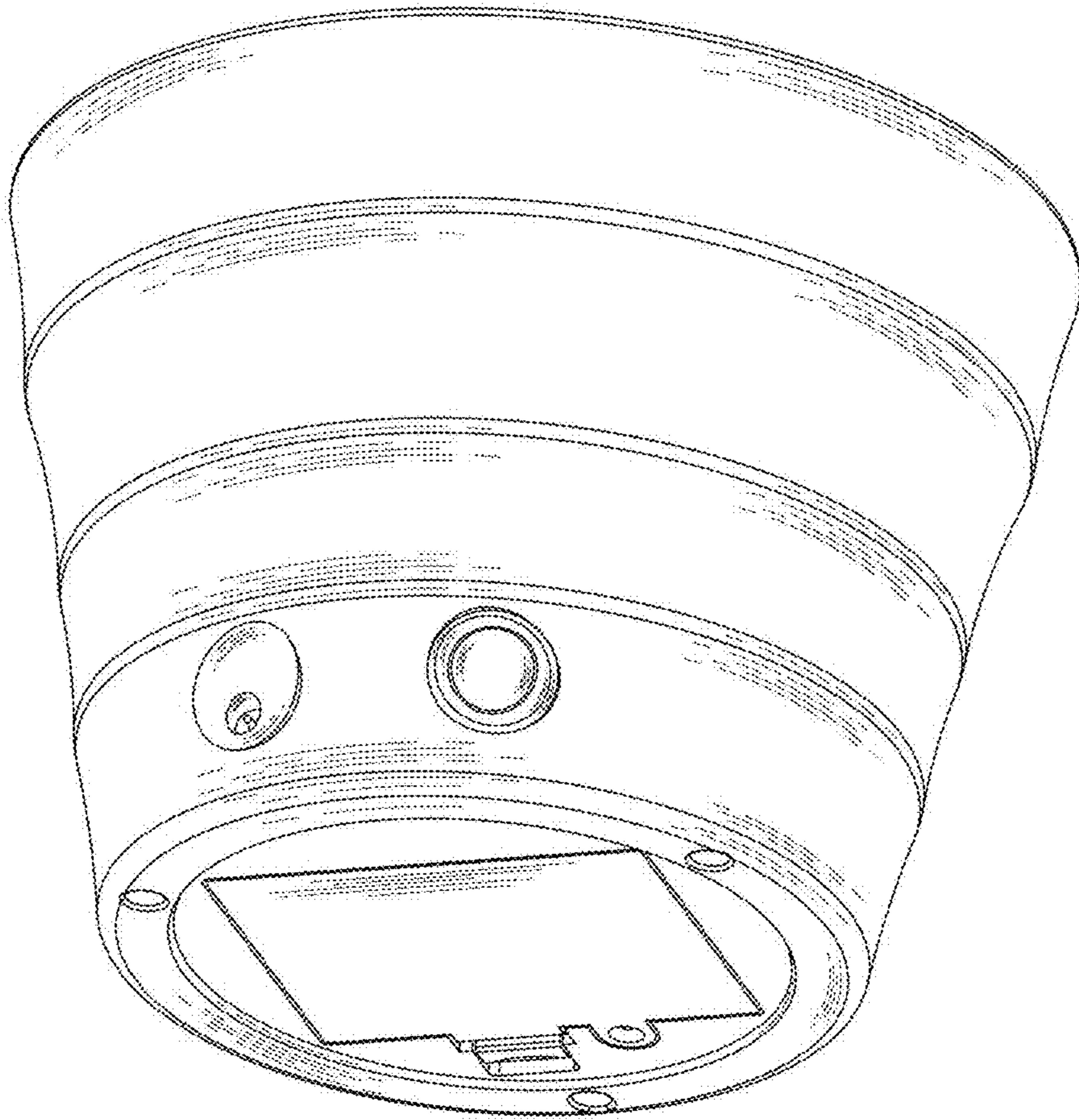

FIG.1

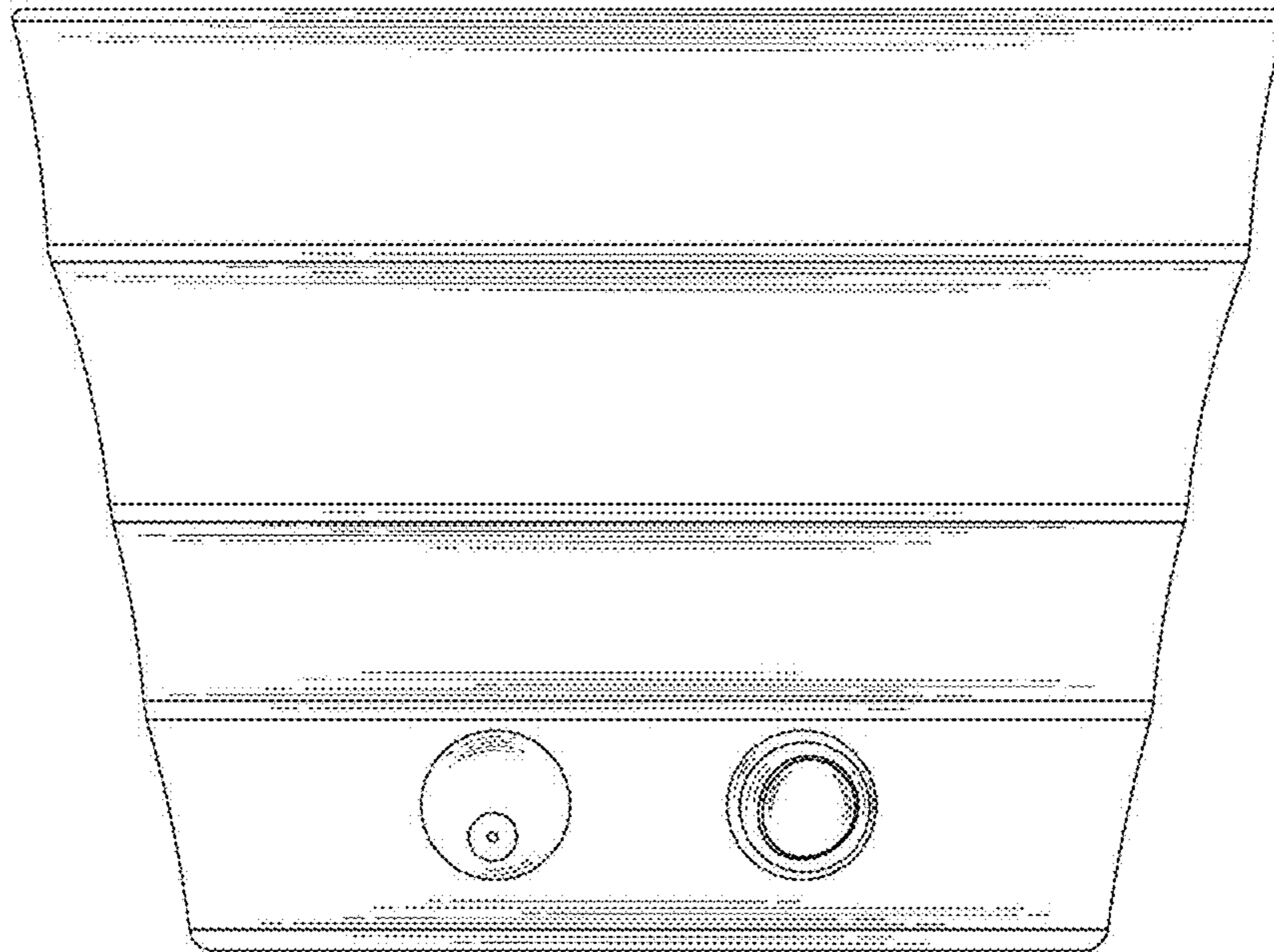

FIG.2

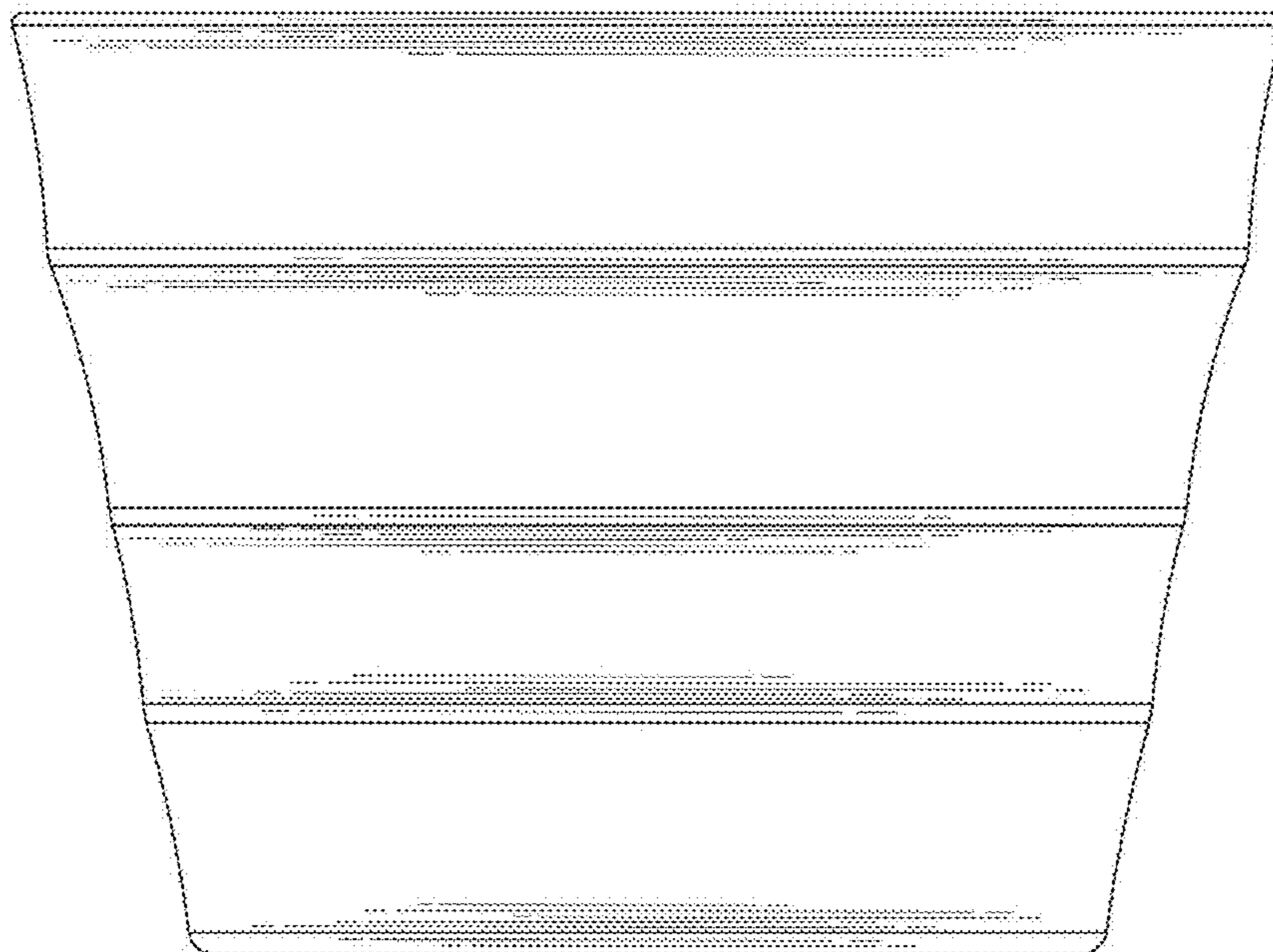

FIG.3





FIG.4

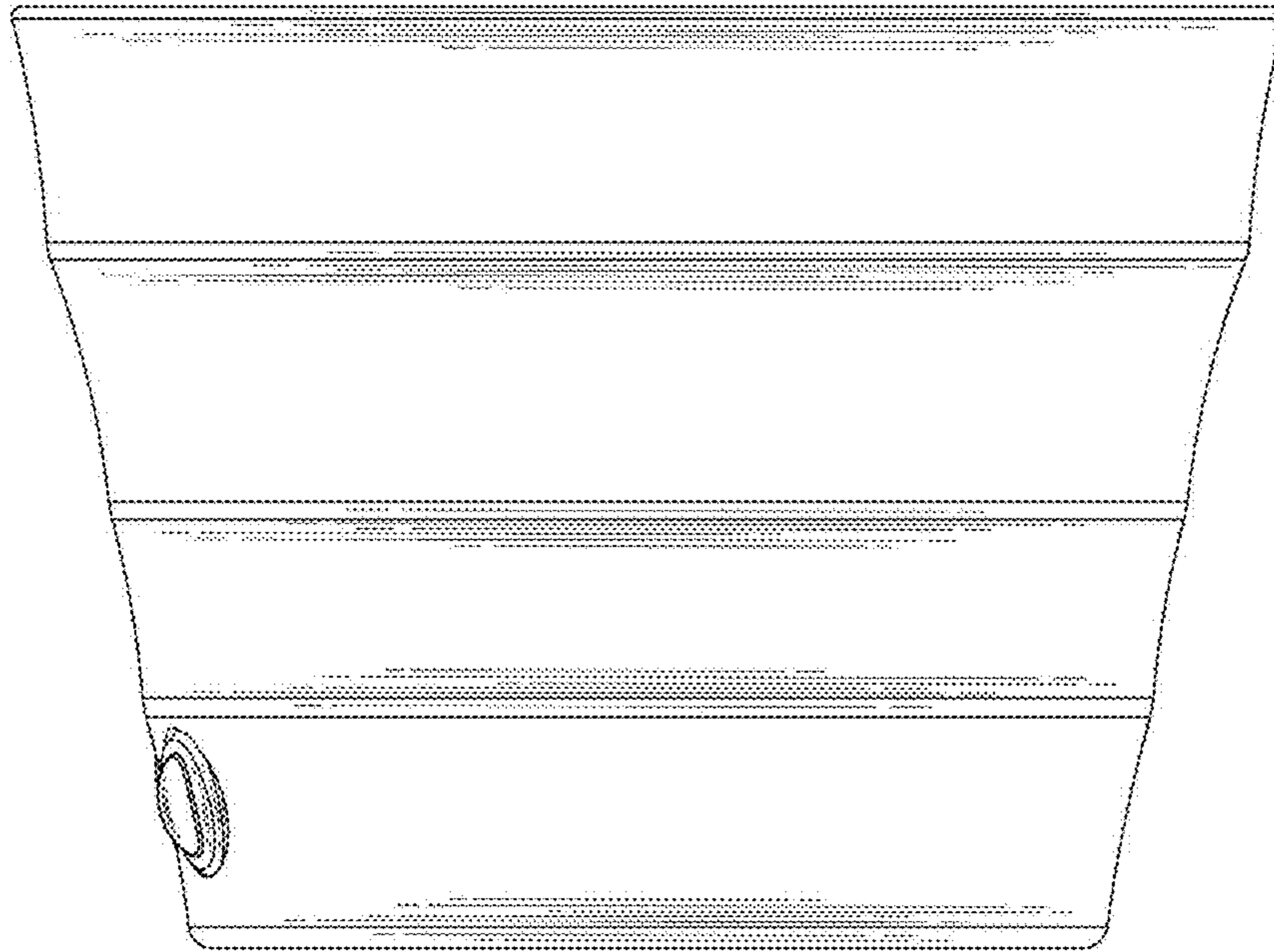

FIG.5

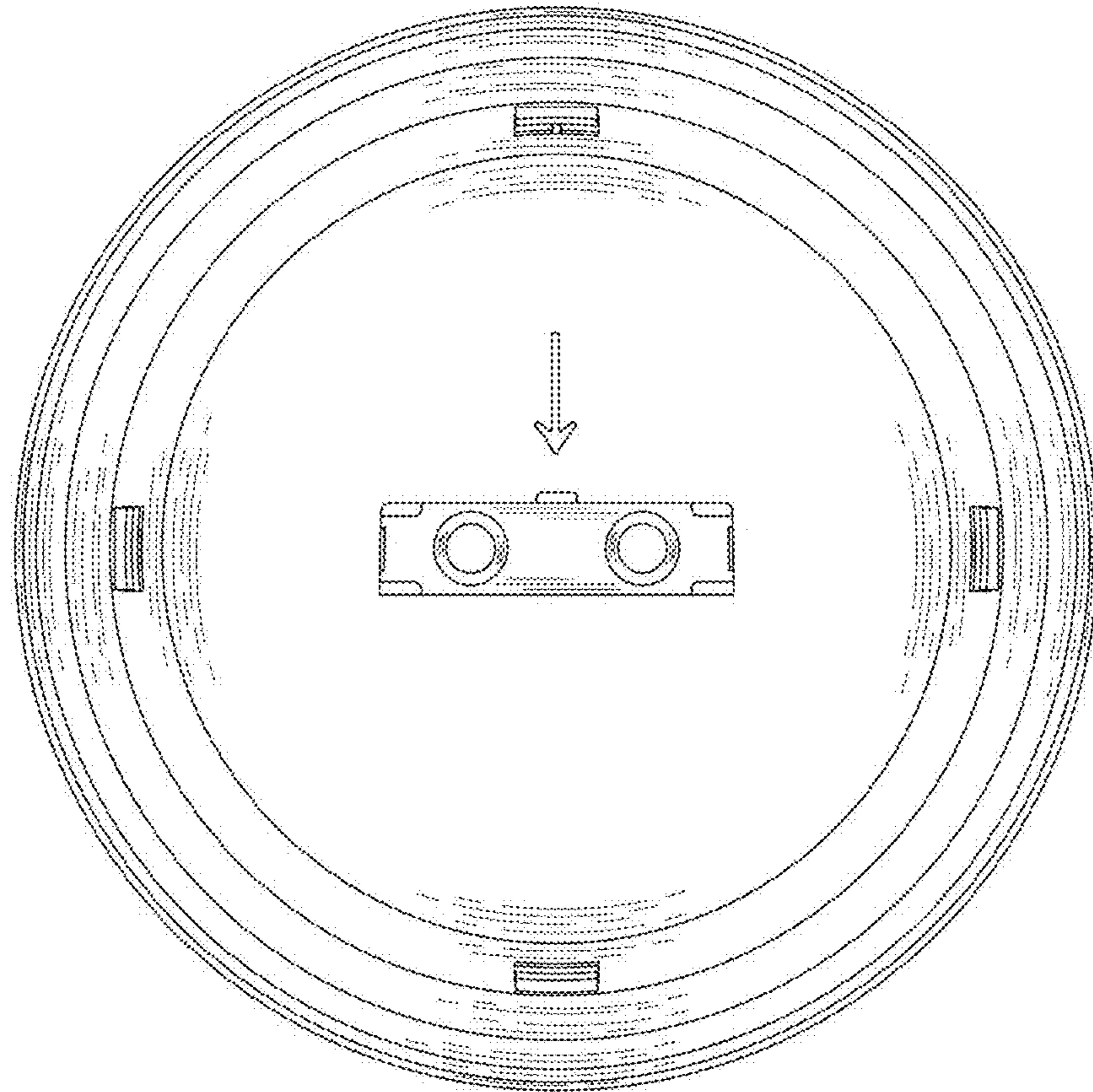

FIG.6

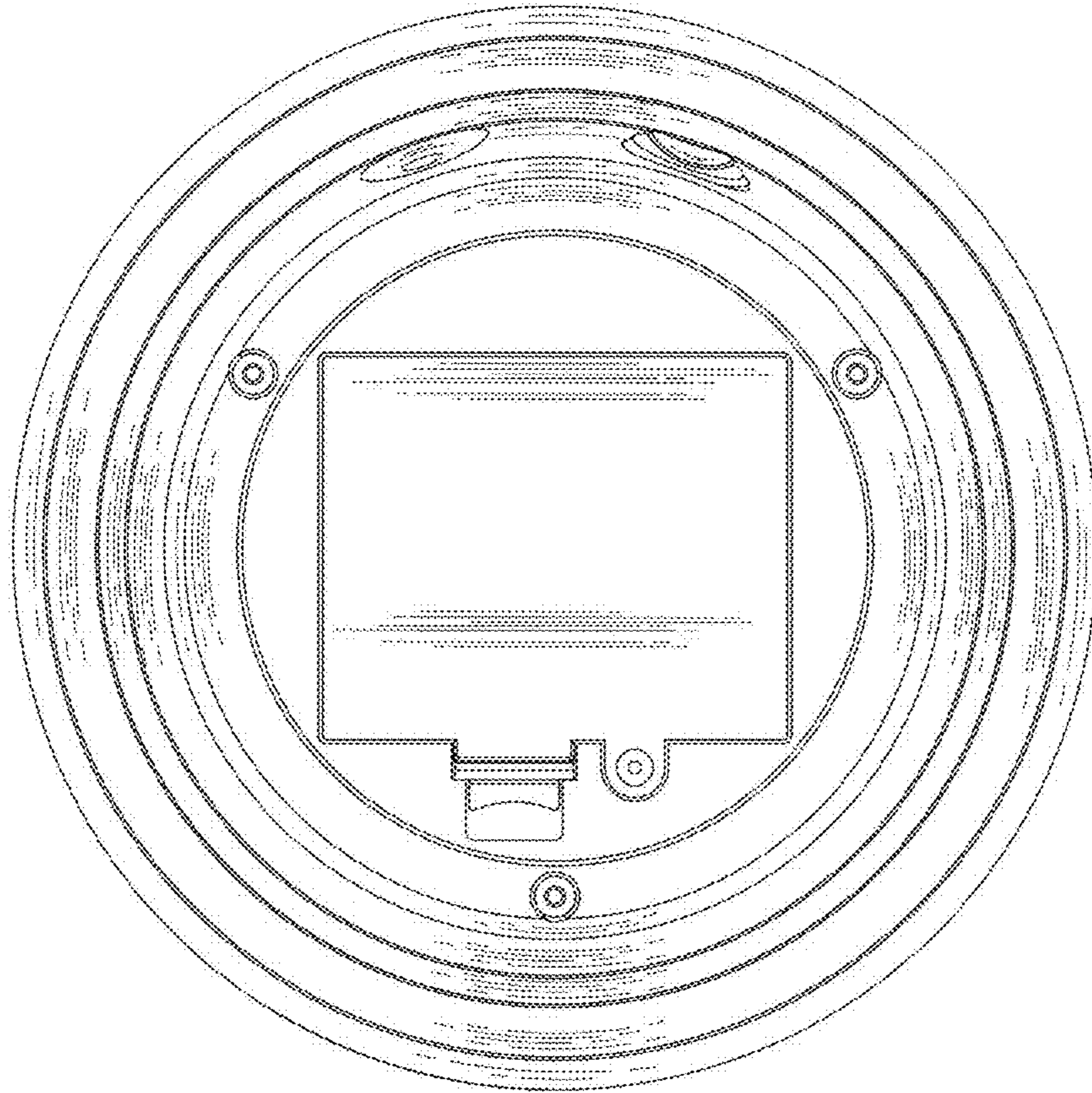

FIG. 7



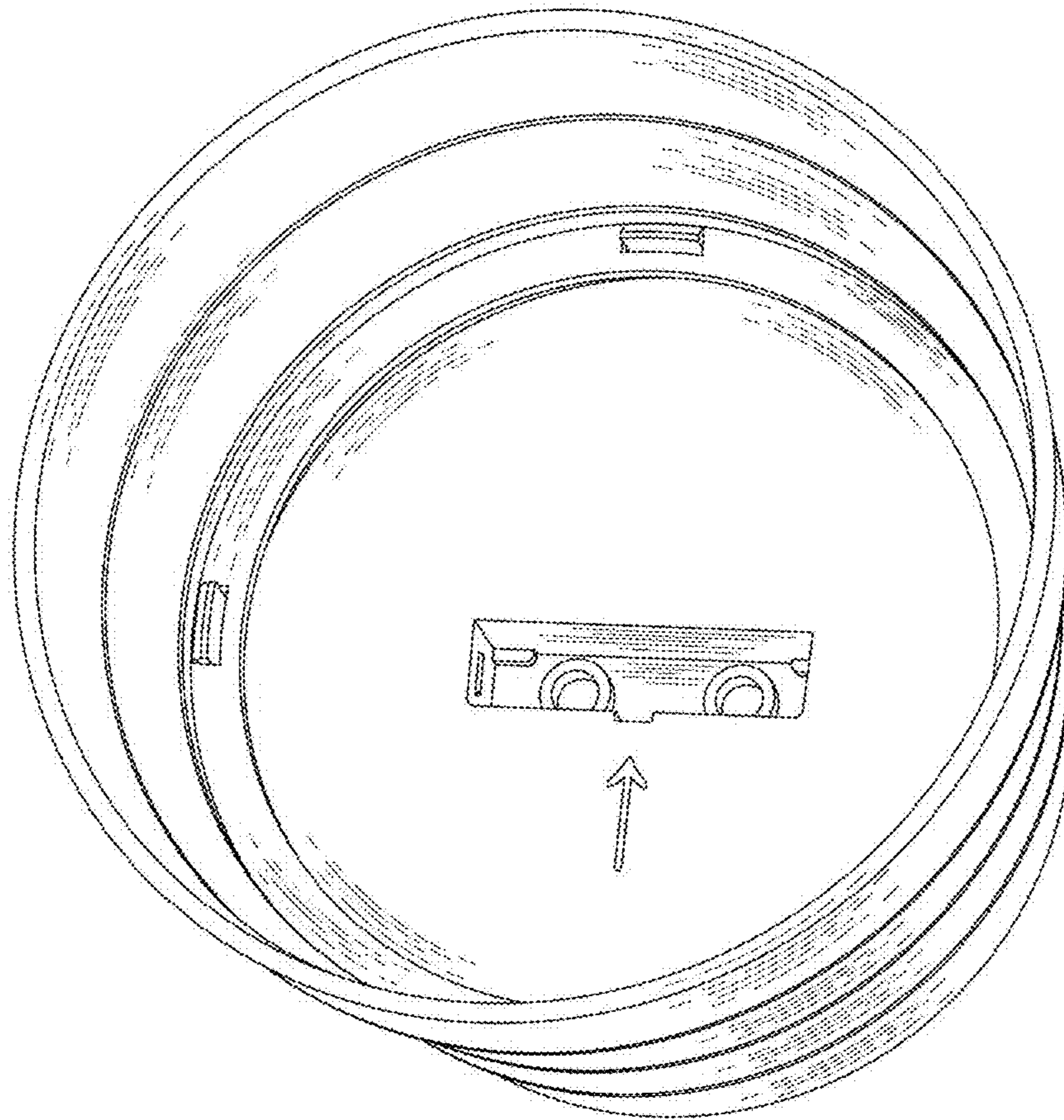

FIG. 8

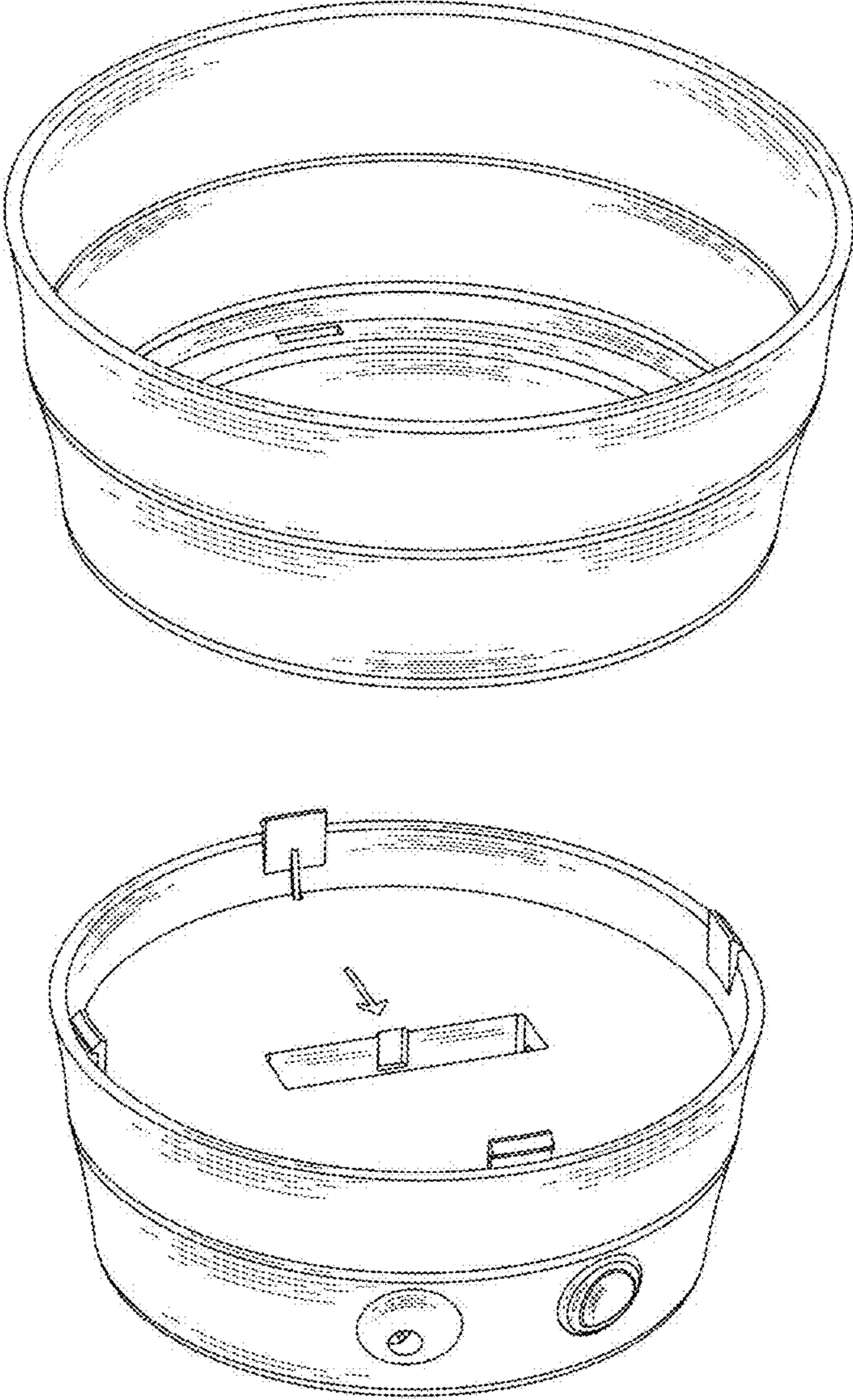

FIG. 9