



US00D965460S

(12) **United States Design Patent** (10) **Patent No.:** **US D965,460 S**
Shimuta (45) **Date of Patent:** **** Oct. 4, 2022**

(54) **SENSOR COVER PACKAGE**

D946,442 S * 3/2022 Russo D10/121
D946,443 S * 3/2022 Russo D10/121
2013/0114918 A1 5/2013 Lyzenga

(71) Applicant: **Murata Manufacturing Co., Ltd.**,
Kyoto (JP)

FOREIGN PATENT DOCUMENTS

(72) Inventor: **Toru Shimuta**, Kyoto (JP)

JP 3102197 U 3/2004
JP D1374545 S 11/2009
JP D1377869 S 1/2010
JP 2013-526466 A 6/2013
JP D1571342 S 3/2017

(73) Assignee: **MURATA MANUFACTURING CO., LTD.**, Kyoto (JP)

(**) Term: **15 Years**

* cited by examiner

(21) Appl. No.: **29/713,816**

Primary Examiner — George D. Kirschbaum

(22) Filed: **Nov. 19, 2019**

(74) *Attorney, Agent, or Firm* — Pearne & Gordon LLP

(30) **Foreign Application Priority Data**

(57) **CLAIM**

May 20, 2019 (JP) 2019-010863

The ornamental design for a sensor cover package, as shown and described.

(51) **LOC (13) Cl.** **10-05**

DESCRIPTION

(52) **U.S. Cl.**
USPC **D10/121**

(58) **Field of Classification Search**
USPC D10/70, 121, 65; D12/400, 240;
D13/184; D14/240
CPC A61B 5/207
See application file for complete search history.

FIG. 1 is a top plan view of a first sensor cover package, showing my new design;
FIG. 2 is a right side elevational view thereof;
FIG. 3 is a back elevational view thereof;
FIG. 4 is a left side elevational view thereof;
FIG. 5 is a bottom plan view thereof;
FIG. 6 is a front elevational view thereof;
FIG. 7 is a perspective view of thereof;
FIG. 8 is a top plan view of a second sensor cover package, showing my new design;
FIG. 9 is a right side elevational view thereof;
FIG. 10 is a back elevational view thereof;
FIG. 11 is a left side elevational view thereof;
FIG. 12 is a bottom plan view thereof;
FIG. 13 is a front elevational view thereof;
FIG. 14 is a perspective view of thereof;
FIG. 15 is a top plan view of a third sensor cover package, showing my new design;
FIG. 16 is a right side elevational view thereof;
FIG. 17 is a back elevational view thereof;
FIG. 18 is a left side elevational view thereof;
FIG. 19 is a bottom plan view thereof;

(56) **References Cited**

U.S. PATENT DOCUMENTS

D462,915 S * 9/2002 Bush D10/121
D756,814 S * 5/2016 Pankewich, Jr. D10/70
D775,537 S * 1/2017 Kikstra D10/70
D778,184 S * 2/2017 Kikstra D10/70
D797,646 S * 9/2017 Ghannam D12/400
D809,995 S * 2/2018 Ghannam D12/400
D813,061 S * 3/2018 Kikstra D10/70
D816,049 S * 4/2018 Kim D13/184
9,962,300 B1 * 5/2018 Hirsch A61B 5/207
D838,230 S * 1/2019 Ghannam D12/400
D838,231 S * 1/2019 Ghannam D12/400
D850,966 S * 6/2019 Laurans D10/121
D871,383 S * 12/2019 Lee D14/240
D876,409 S * 2/2020 Lee D14/240

(Continued)

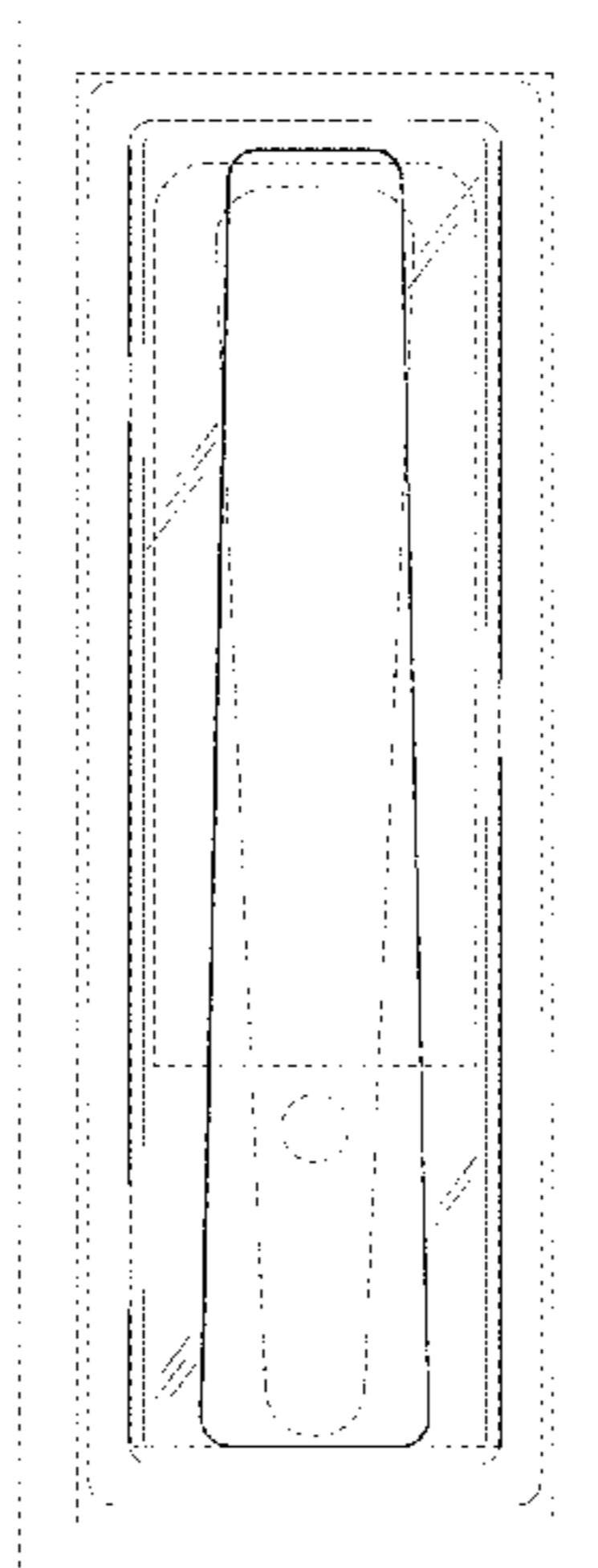

FIG. 20 is a front elevational view thereof;

FIG. 21 is a perspective view of thereof;

FIG. 22 is a top plan view of a fourth sensor cover package, showing my new design; the right side elevational view, the back elevational view, the left side elevational view, the bottom plan view, and the front elevational view are the same as those of the first sensor cover package shown in FIGS. 2-6;

FIG. 23 is a top plan view a fifth sensor cover package, showing my new design, the right side elevational view, the back elevational view, the left side elevational view, the bottom plan view, and the front elevational view are the same as those of the first sensor cover package shown in FIGS. 2-6;

FIG. 24 is a top plan view a sixth sensor cover package, showing my new design, the right side elevational view, the back elevational view, the left side elevational view, the bottom plan view, and the front elevational view are the same as those of the first sensor cover package shown in FIGS. 2-6;

FIG. 25 is a top plan view a seventh sensor cover package, showing my new design, the right side elevational view, the back elevational view, the left side elevational view, the bottom plan view, and the front elevational view are the same as those of the first sensor cover package shown in FIGS. 2-6;

FIG. 26 is a top plan view a ninth sensor cover package, showing my new design, the right side elevational view, the

back elevational view, the left side elevational view, the bottom plan view, and the front elevational view are the same as those of the third sensor cover package shown in FIGS. 16-20;

FIG. 27 is a top plan view a tenth sensor cover package, showing my new design, the right side elevational view, the back elevational view, the left side elevational view, the bottom plan view, and the front elevational view are the same as those of the third sensor cover package shown in FIGS. 16-20;

FIG. 28 is a top plan view an eleventh sensor cover package, showing my new design, the right side elevational view, the back elevational view, the left side elevational view, the bottom plan view, and the front elevational view are the same as those of the third sensor cover package shown in FIGS. 16-20; and,

FIG. 29 is a top plan view a twelfth sensor cover package, showing my new design, the right side elevational view, the back elevational view, the left side elevational view, the bottom plan view, and the front elevational view are the same as those of the third sensor cover package shown in FIGS. 16-20.

The broken lines in the drawings are used to illustrate unclaimed environmental structure and form no part of the claimed design.

1 Claim, 13 Drawing Sheets

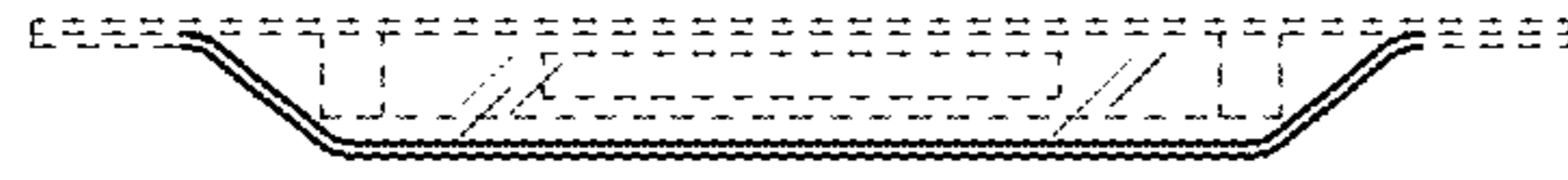

FIG. 3

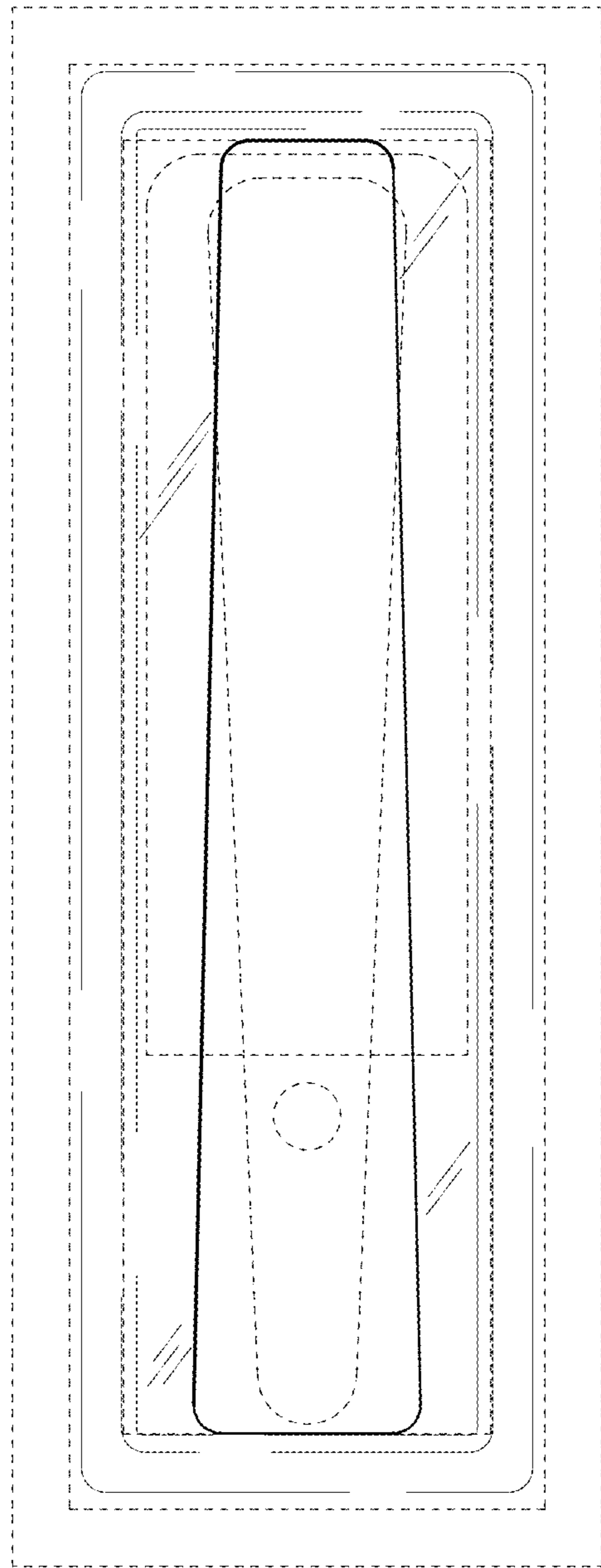

FIG. 1

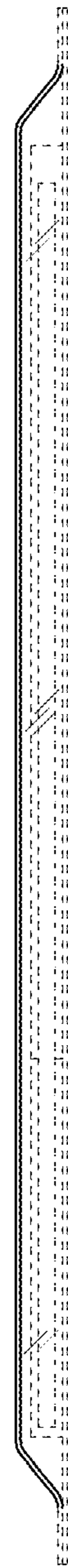

FIG. 2

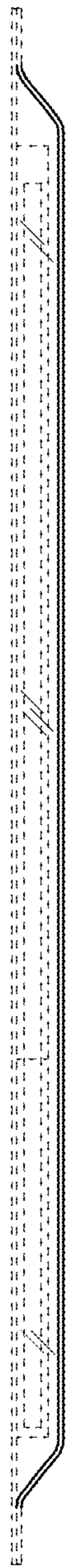

FIG. 4

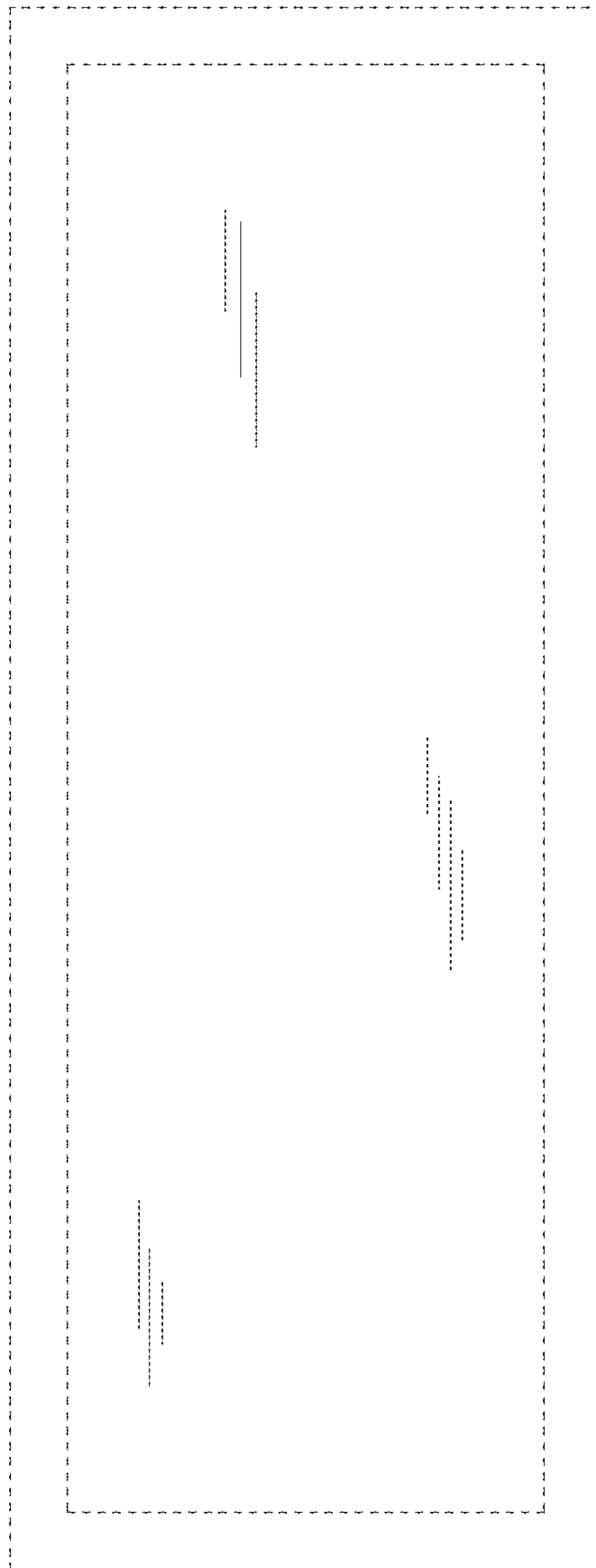

FIG. 5

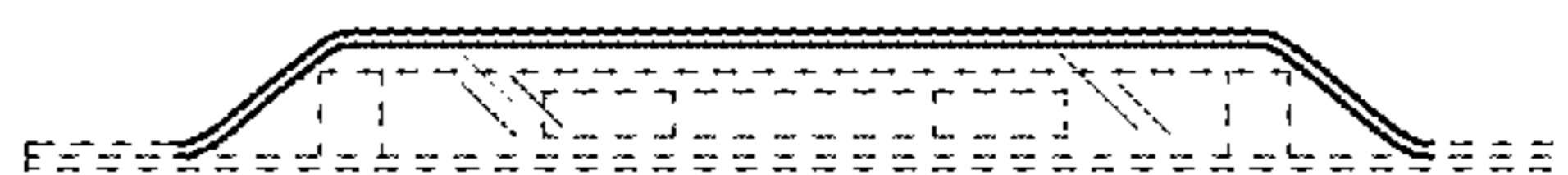
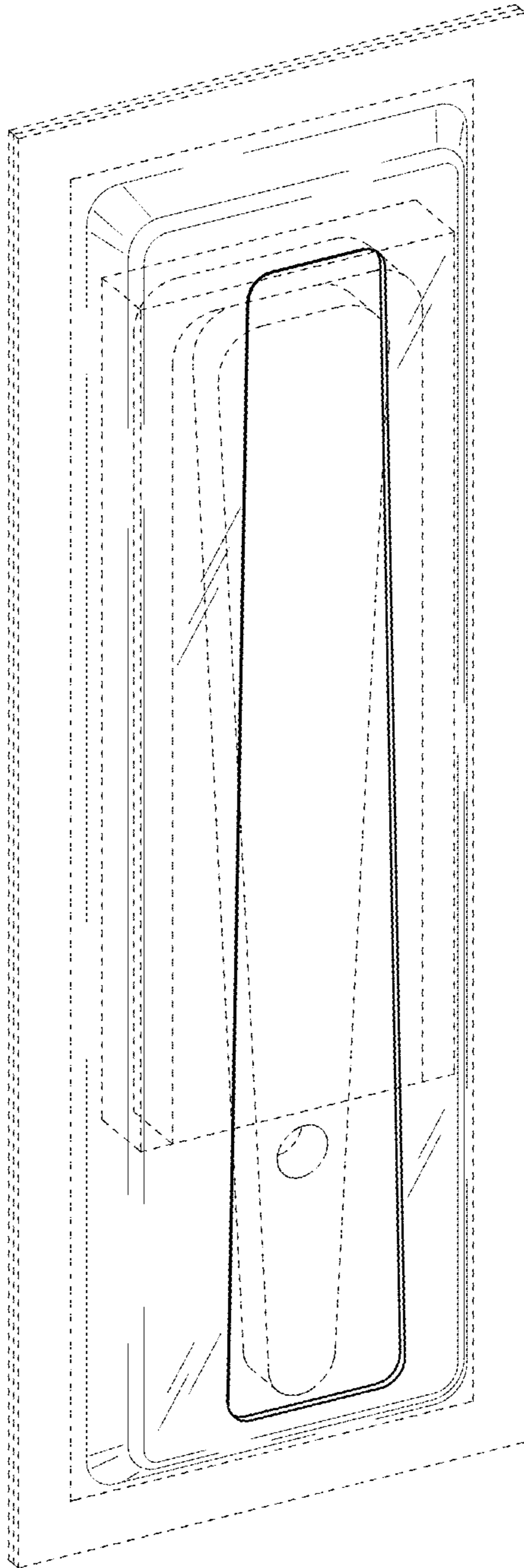

FIG. 6

FIG. 7



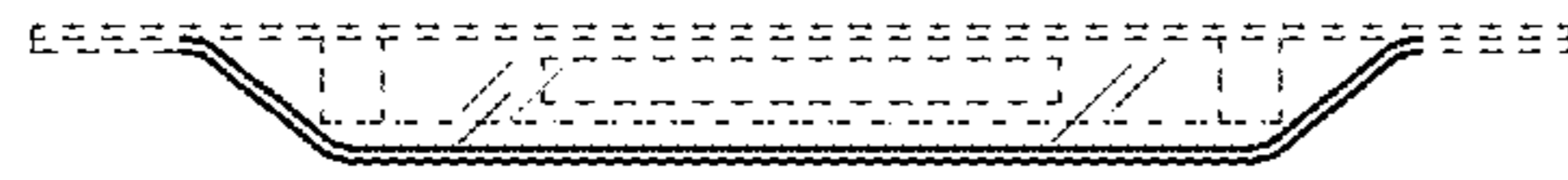

FIG. 10

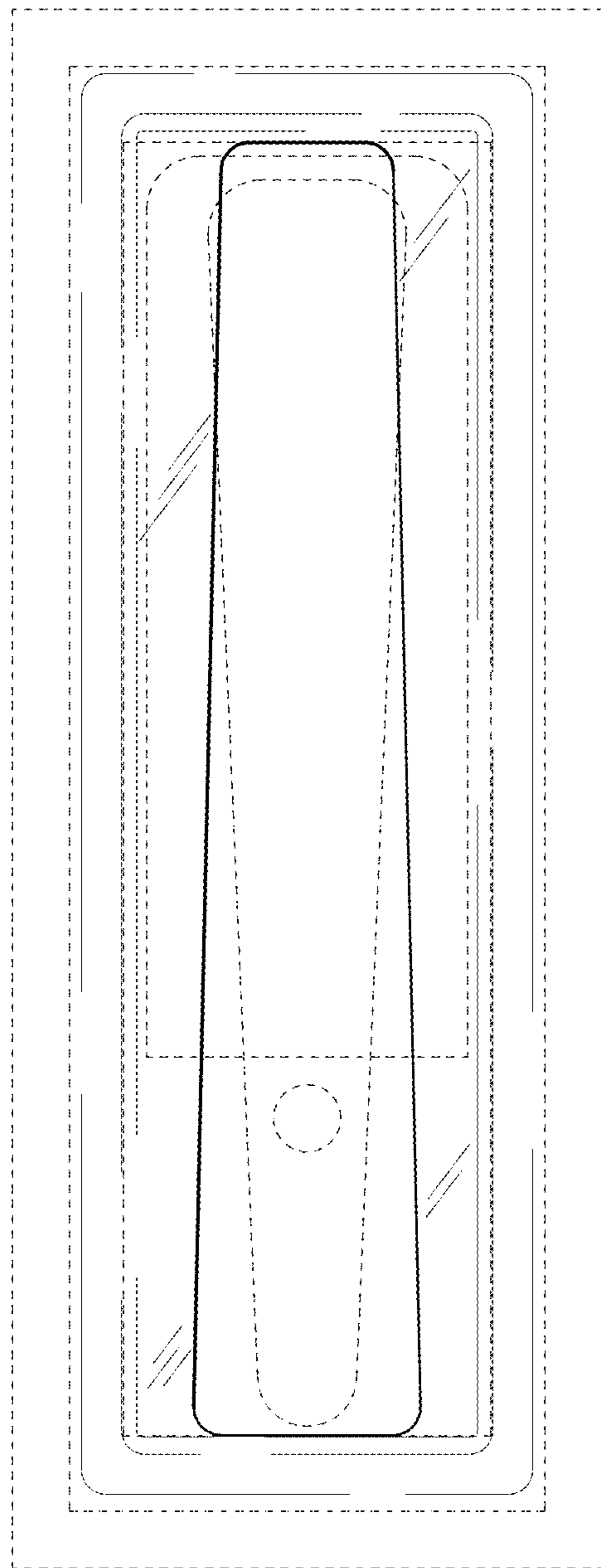

FIG. 8

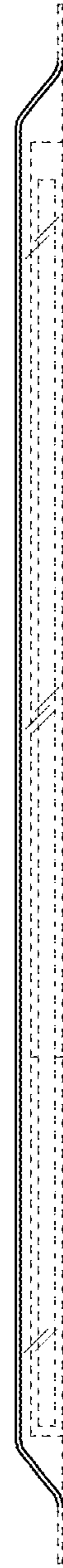

FIG. 9

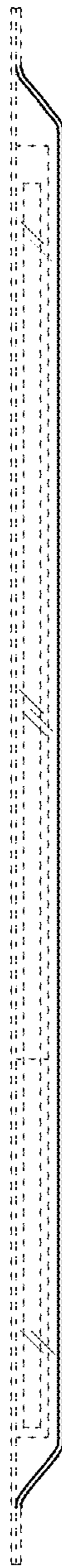

FIG. 1 1

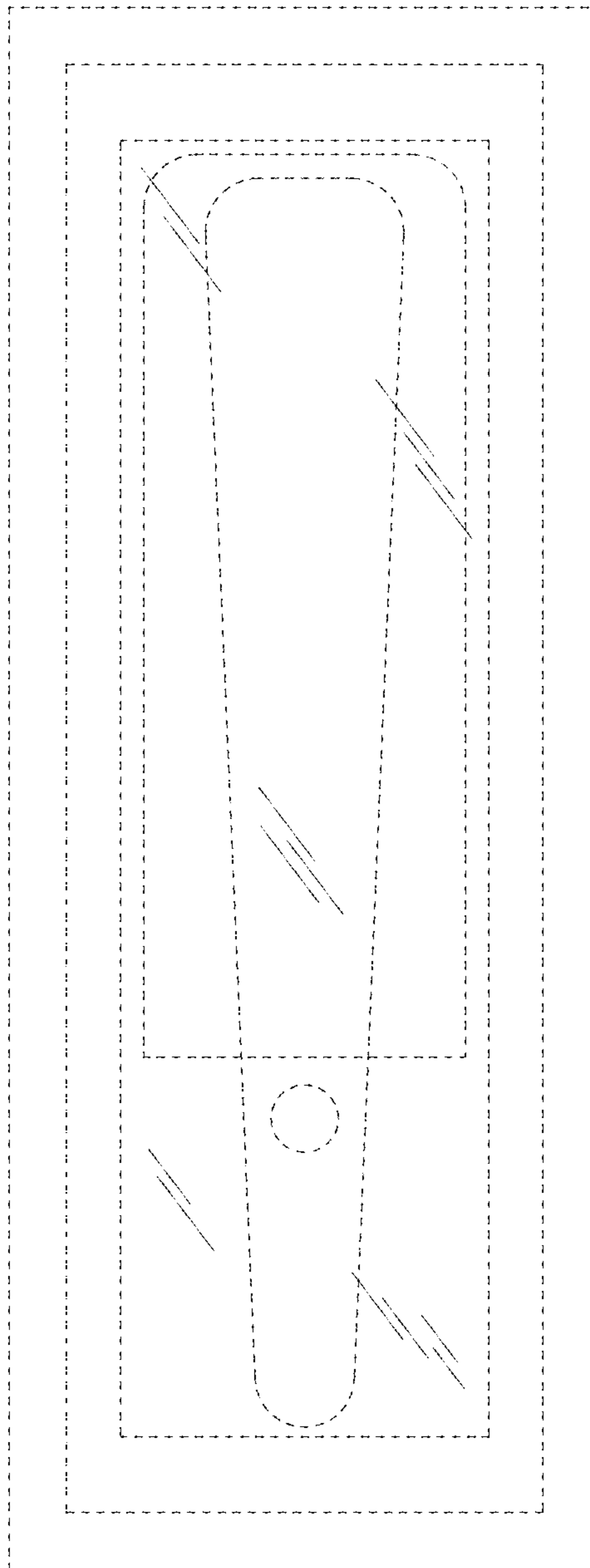

FIG. 1 2

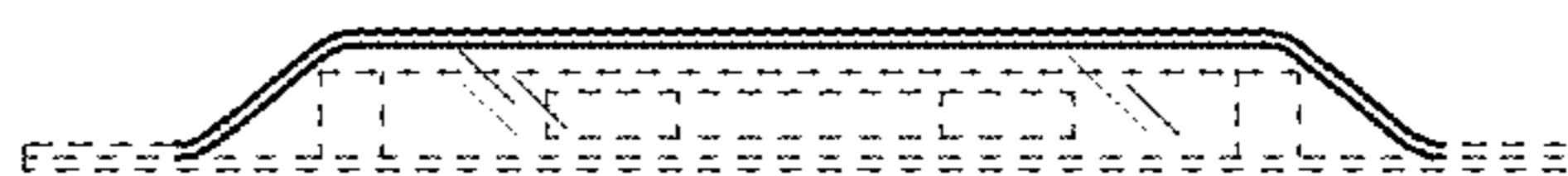
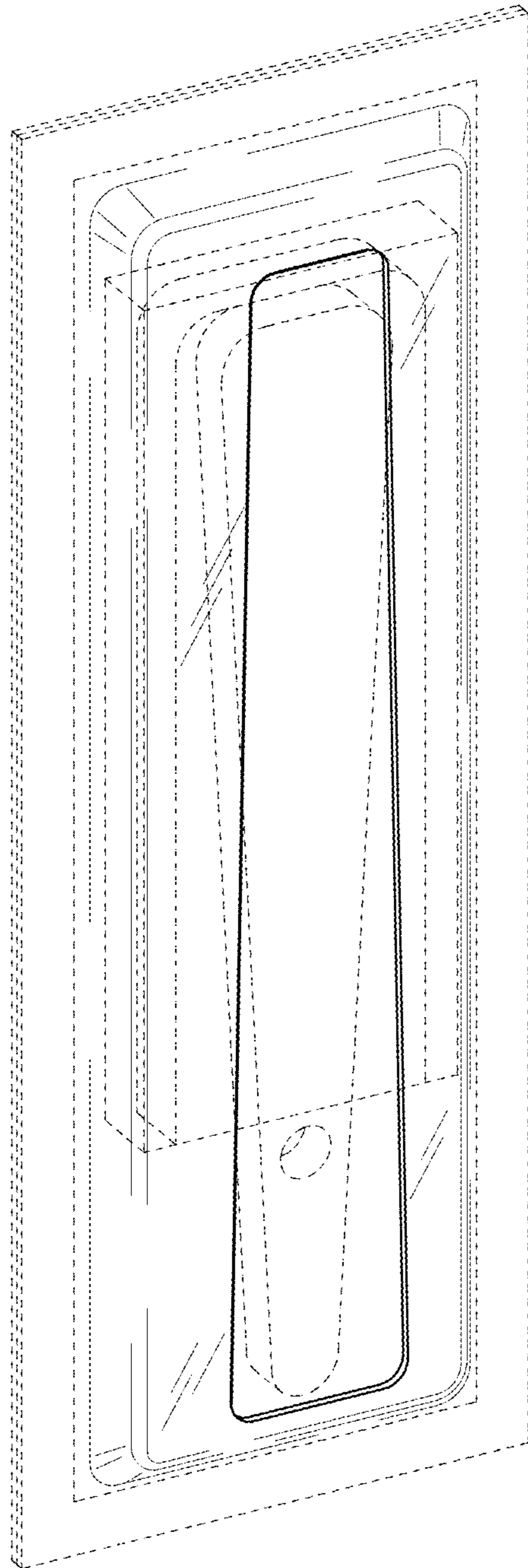

FIG. 1 3

FIG. 14



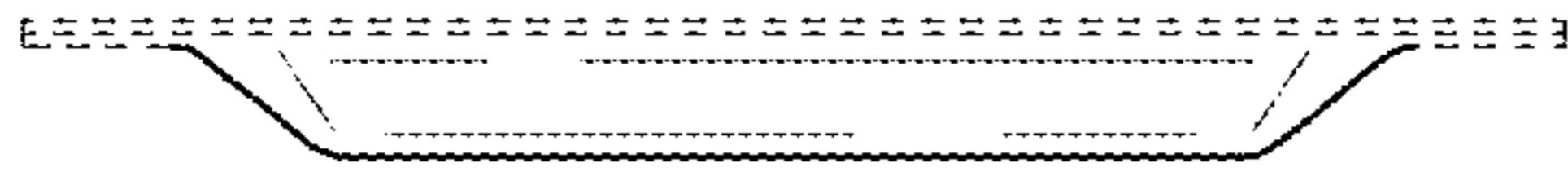

FIG. 17

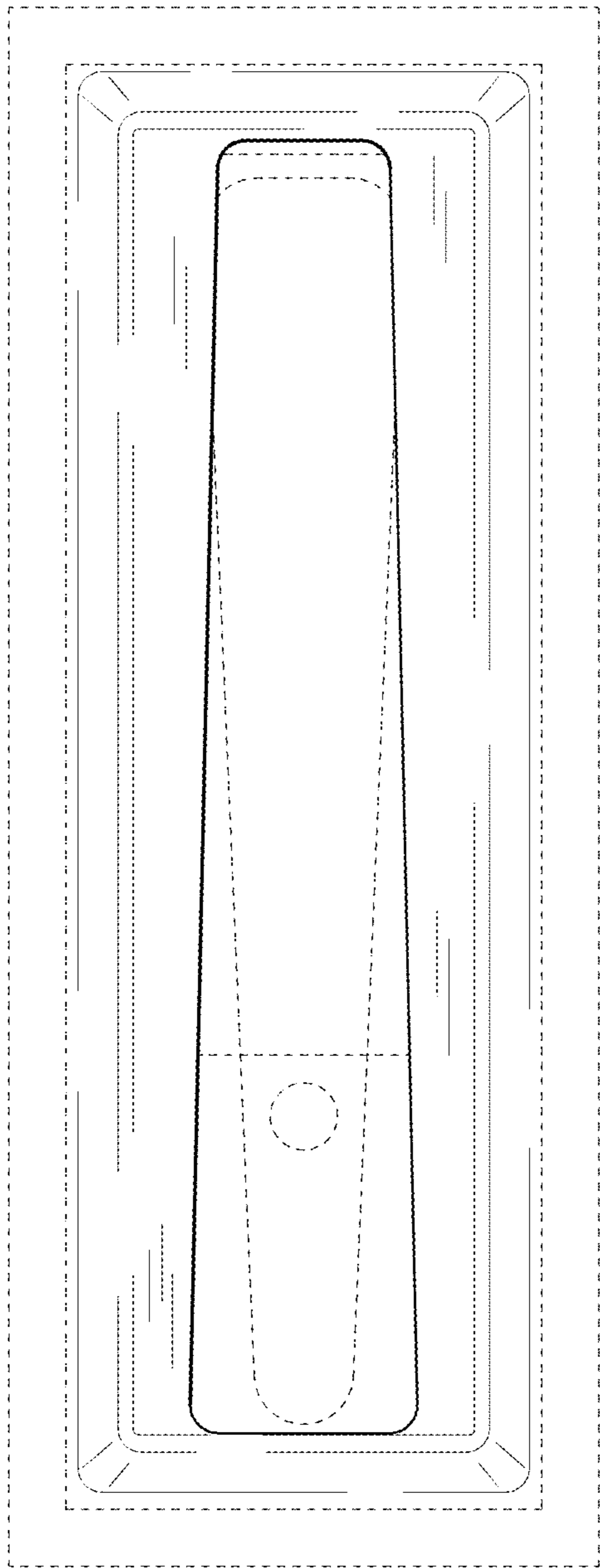

FIG. 15

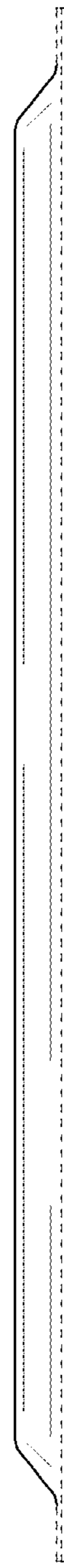

FIG. 16

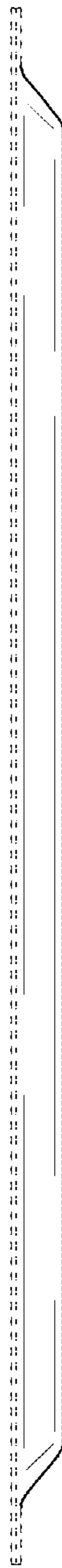

FIG. 18

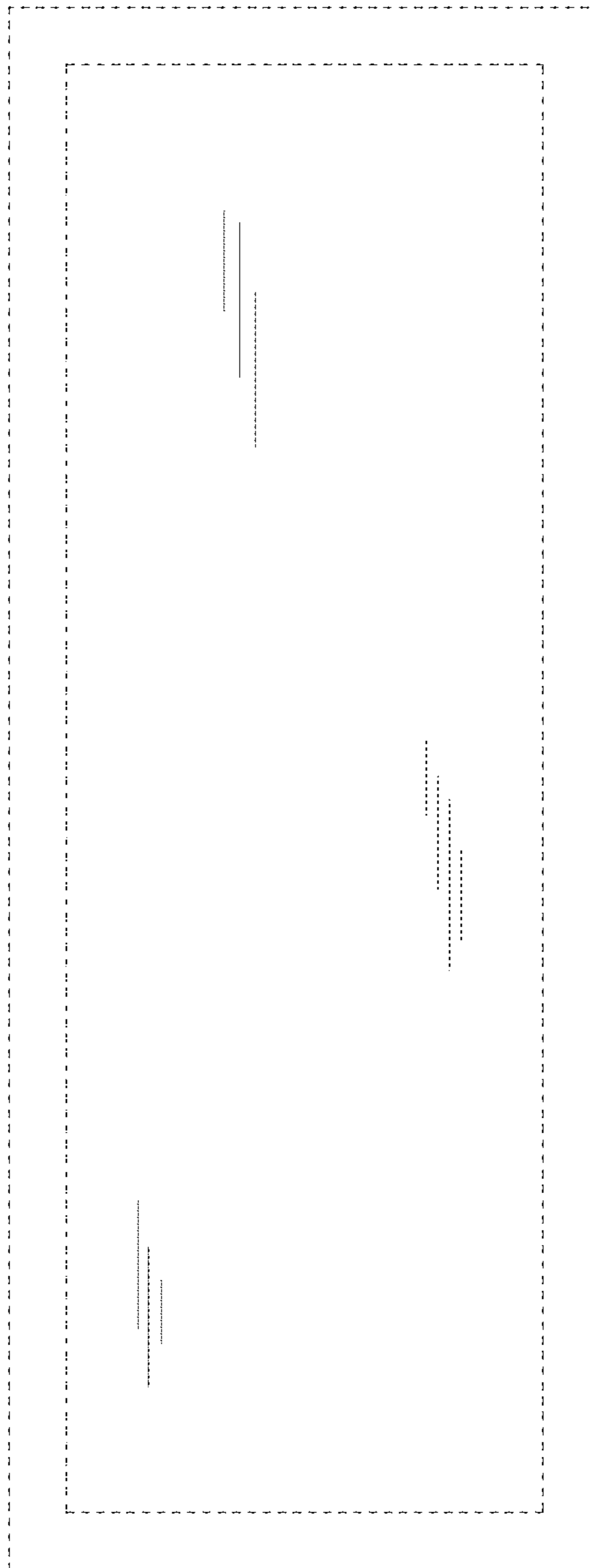

FIG. 19

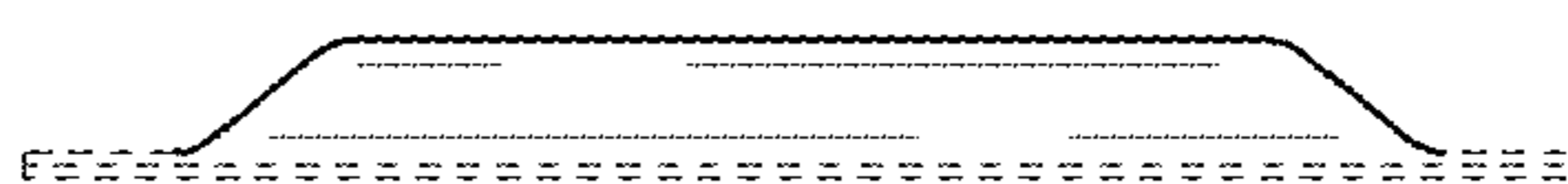
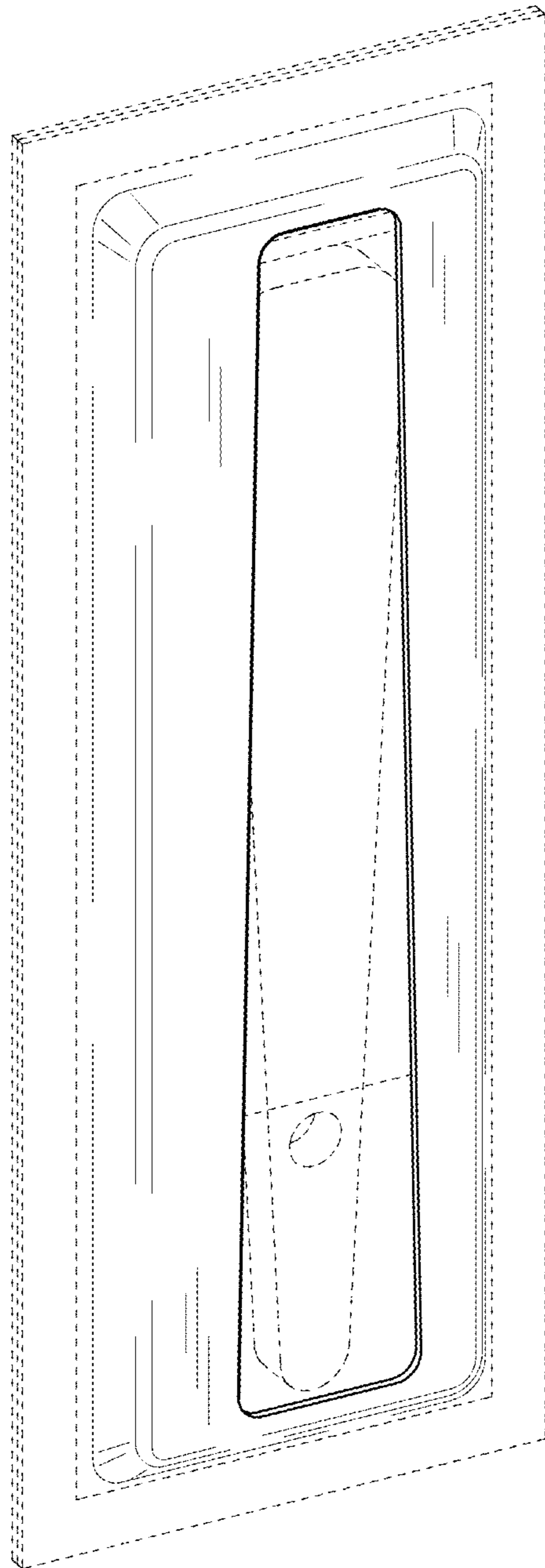

FIG. 20

FIG. 21



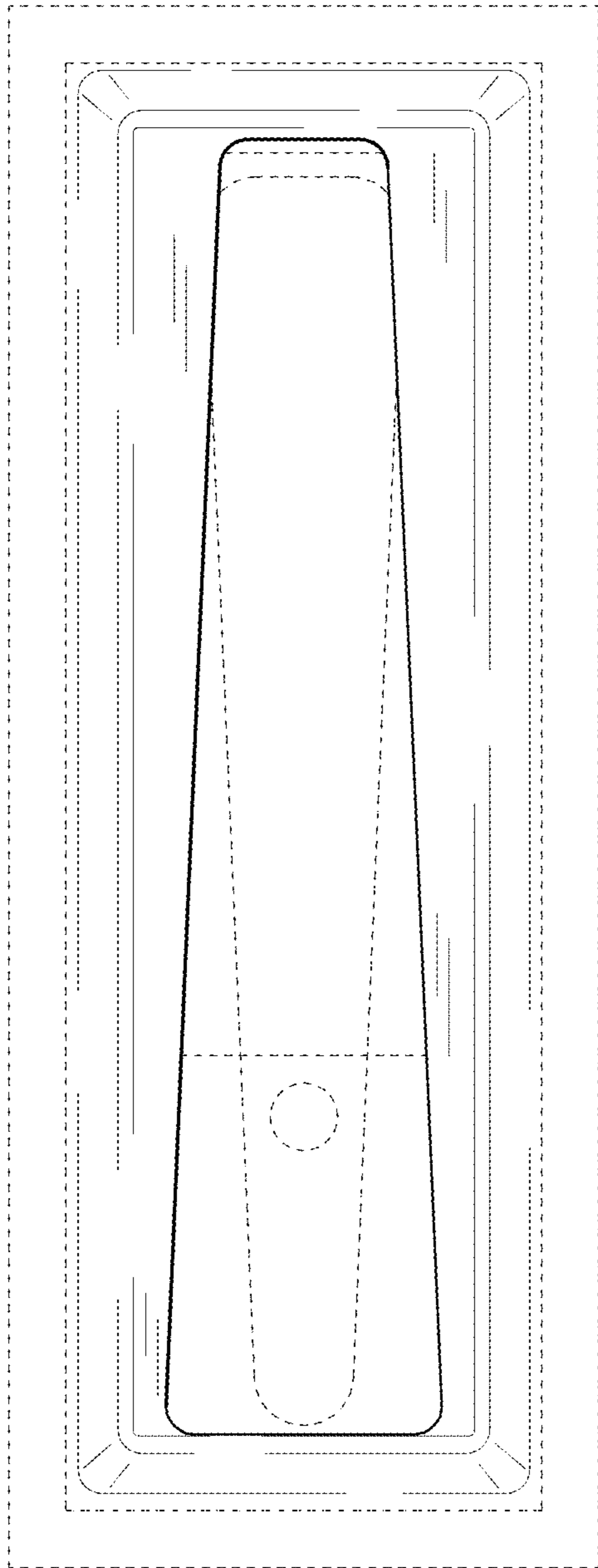

FIG. 22

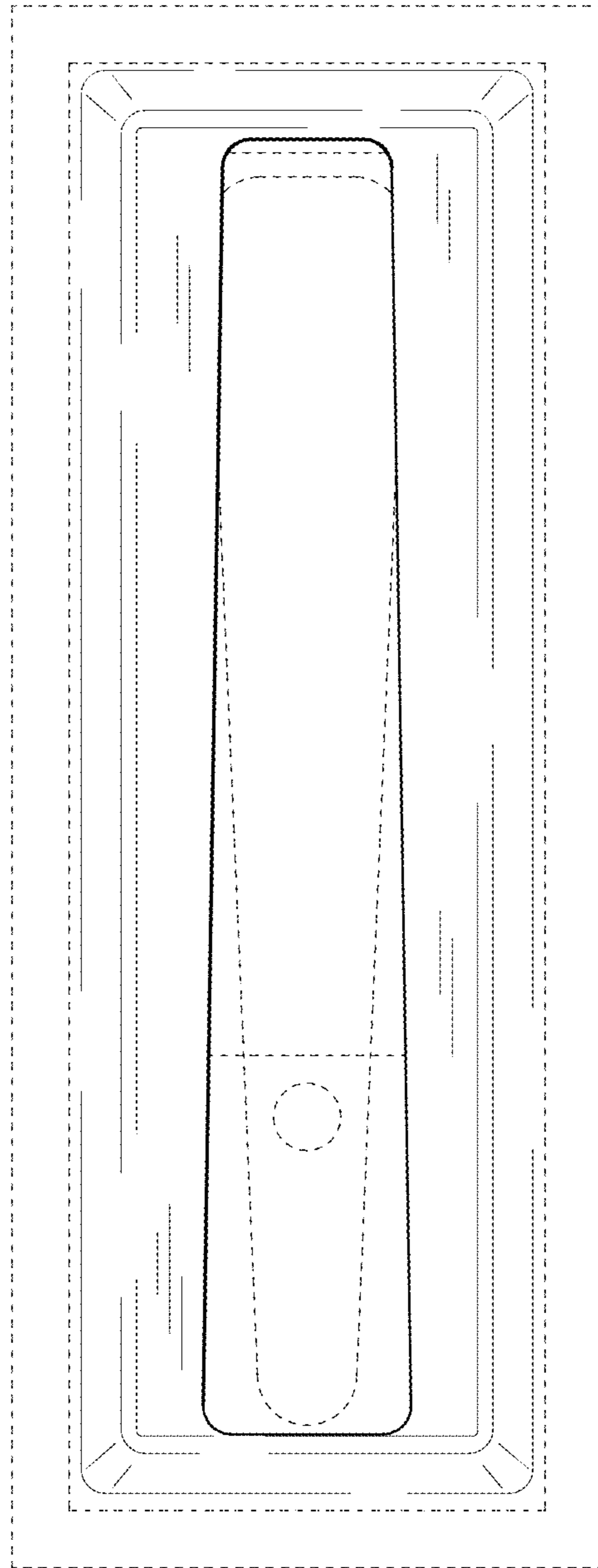

FIG. 23

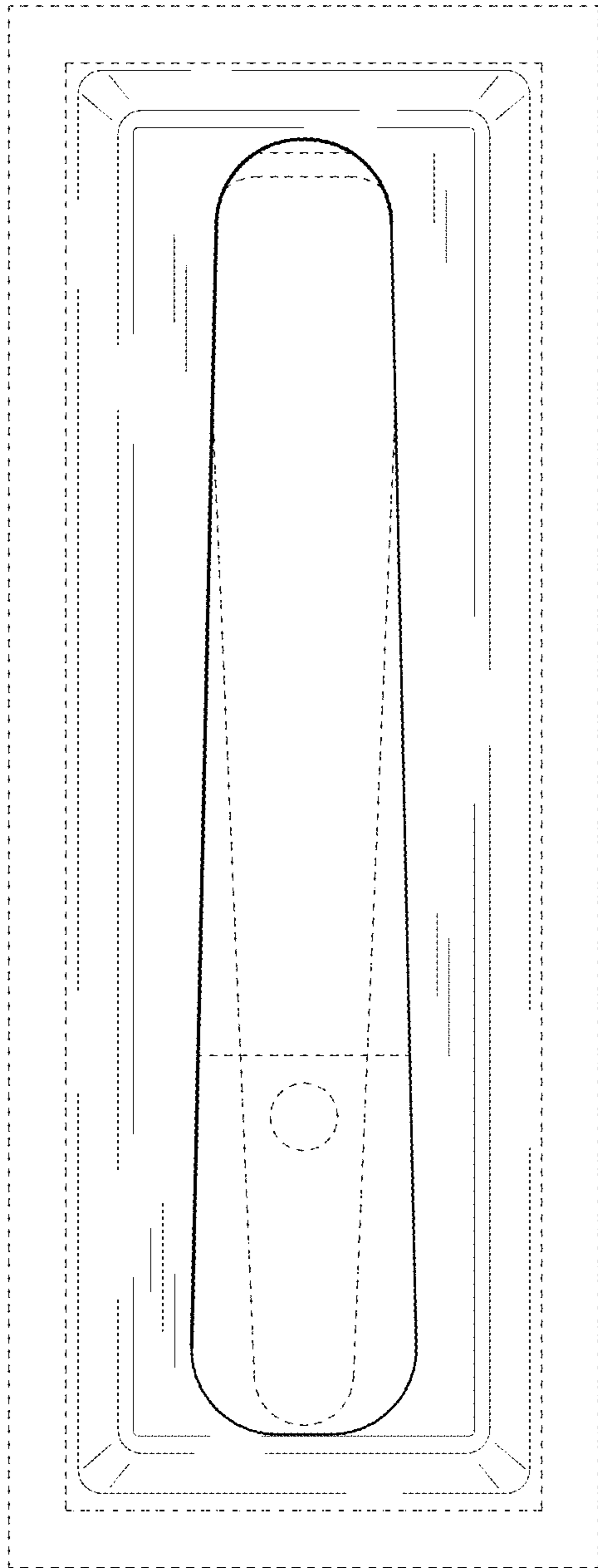

FIG. 24

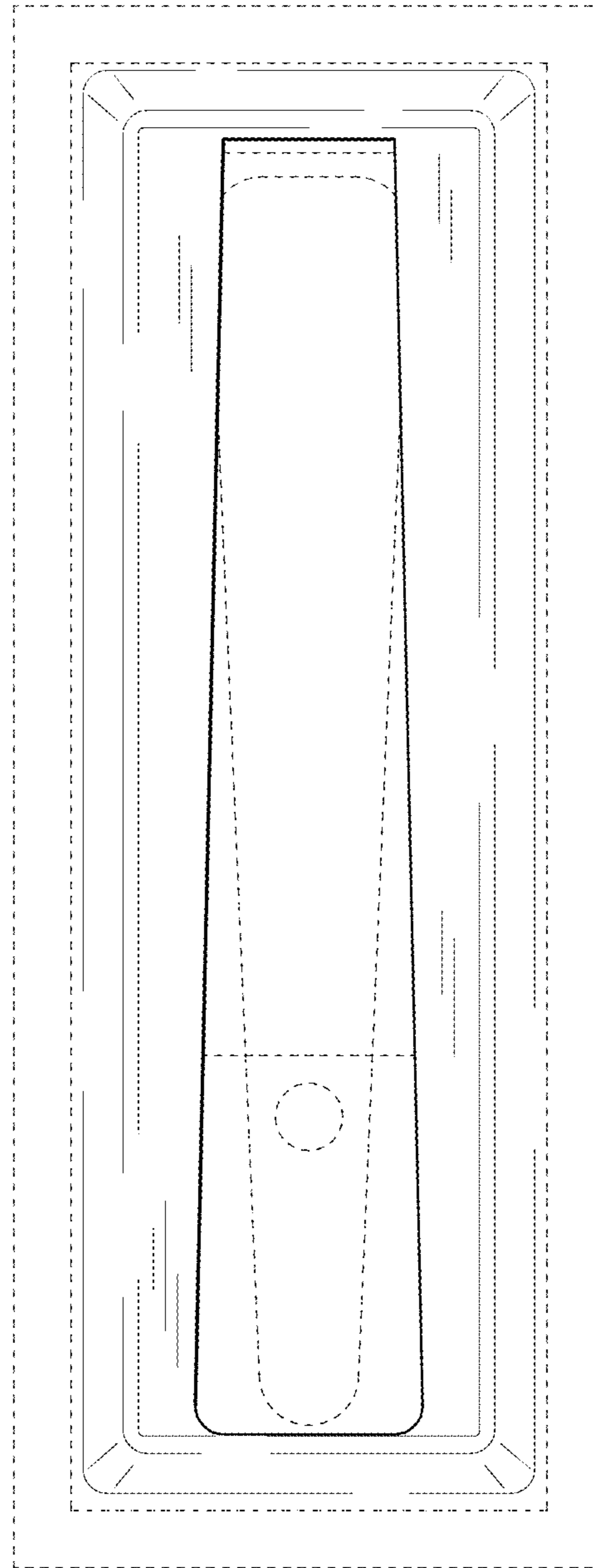

FIG. 25

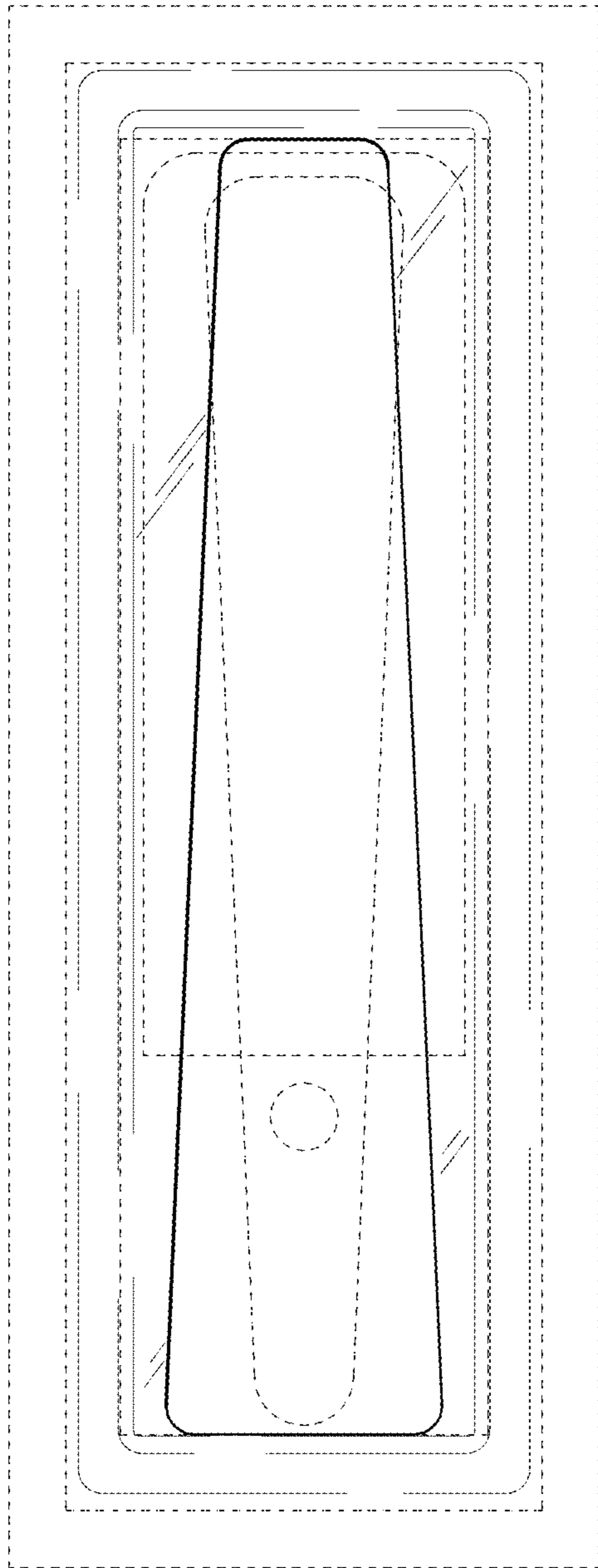

FIG. 26

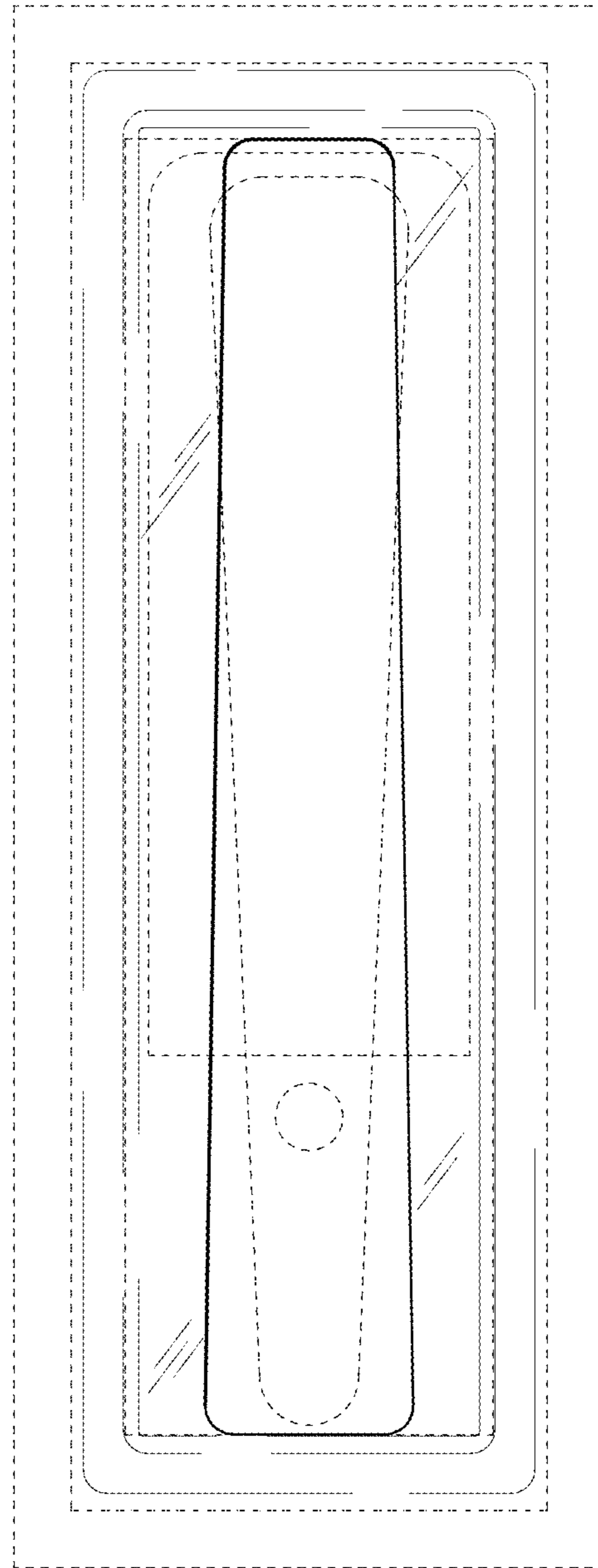

FIG. 27

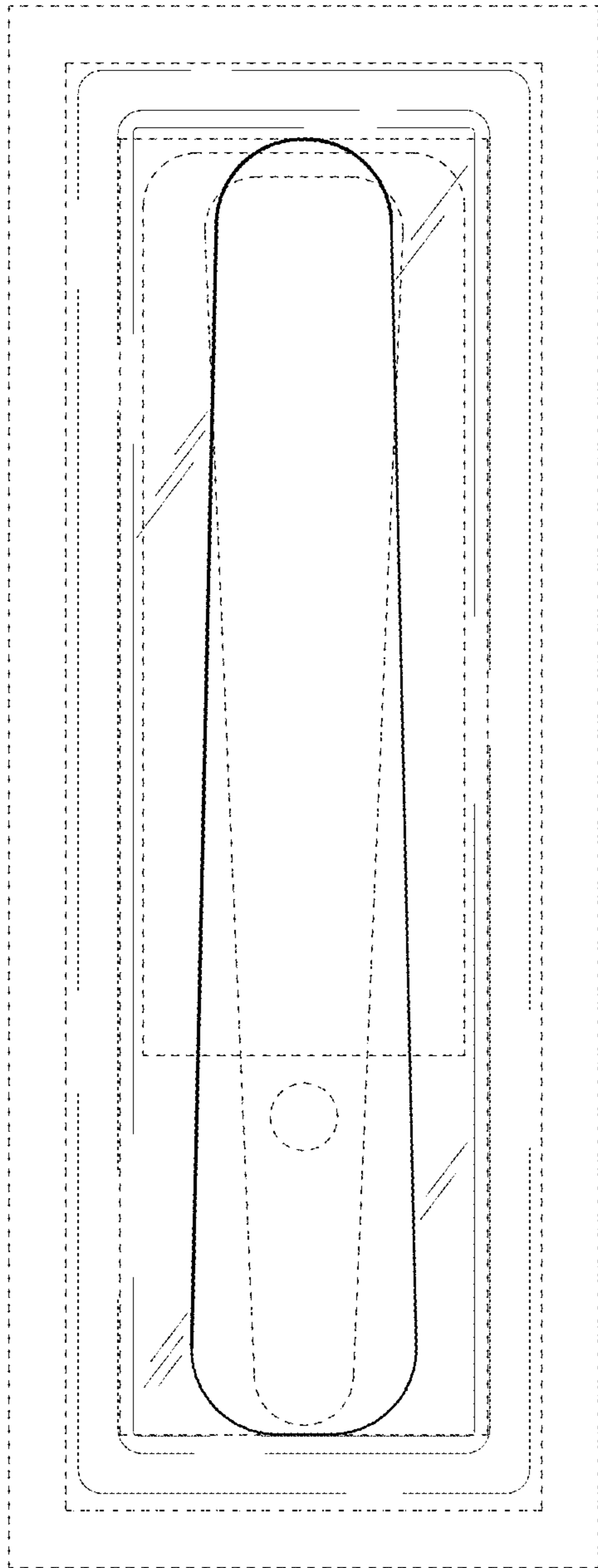

FIG. 28

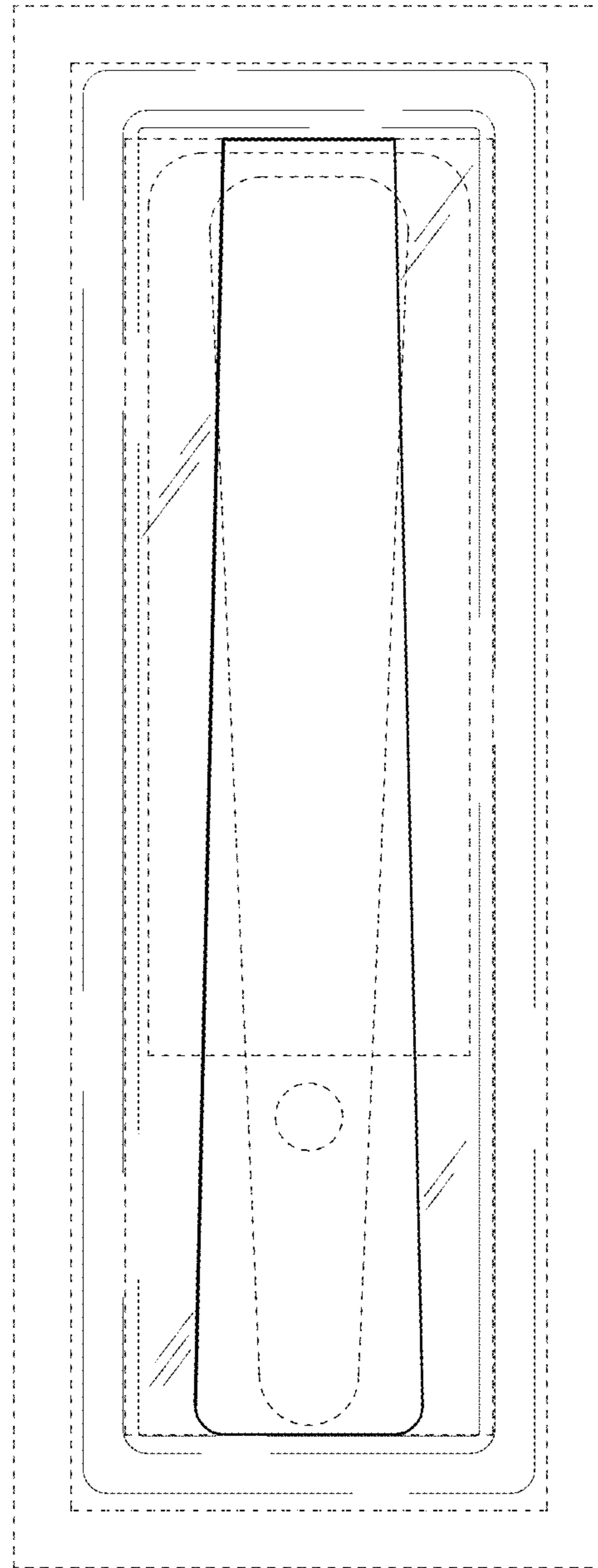

FIG. 29