



US00D965435S

(12) **United States Design Patent** (10) **Patent No.:** **US D965,435 S**  
**Broen et al.** (45) **Date of Patent:** **\*\* Oct. 4, 2022**

(54) **BOTTLE**  
(71) Applicant: **PepsiCo, Inc.**, Purchase, NY (US)  
(72) Inventors: **Martin Eduardo Broen**, New York, NY (US); **William R. Eaton**, Southbury, CT (US); **Christopher Andrew Gregory**, New York, NY (US); **Niklas Gustafsson**, New York, NY (US); **Stephen Lim**, Chappaqua, NY (US); **Kai Xiang Lin**, Flushing, NY (US); **Qiuchen Peter Zhang**, Mahwah, NJ (US)

(73) Assignee: **PepsiCo, Inc.**, Purchase, NY (US)

(\*\*) Term: **15 Years**

(21) Appl. No.: **29/746,755**

(22) Filed: **Aug. 17, 2020**

(51) **LOC (13) Cl.** ..... **09-01**

(52) **U.S. Cl.**  
USPC ..... **D9/538; D9/550; D9/552; D9/557**

(58) **Field of Classification Search**  
USPC ..... D9/434, 516, 530, 537-540, 549, 550, D9/552, 557, 565, 575, 715, 719  
CPC ..... B65D 1/00; B65D 1/02; B65D 1/0223; B65D 23/00; B65D 23/102; B65D 2501/00; B65D 2501/0009; B65D 2501/0018; B65D 2501/0036  
See application file for complete search history.

(56) **References Cited**

**U.S. PATENT DOCUMENTS**

D383,677 S *	9/1997	Darr	.....	D9/520
D409,919 S *	5/1999	Young	.....	D9/520
D434,668 S *	12/2000	Chimetto	.....	D9/570
D466,023 S *	11/2002	Eickmeier	.....	D9/556
D496,280 S	9/2004	Mero et al.		
D509,436 S	9/2005	Mero et al.		

D509,746 S *	9/2005	Mero	.....	D9/558
D510,271 S	10/2005	Mero et al.		
D515,933 S	2/2006	Mero et al.		
D559,694 S	1/2008	Le Bras-Brown et al.		
D561,595 S *	2/2008	Le Bras-Brown	.....	D9/520
D561,597 S	2/2008	Venkataraman et al.		
D567,663 S *	4/2008	Kinmont	.....	D9/551
D603,268 S *	11/2009	Bourne	.....	D9/557
D637,908 S *	5/2011	Fleischhacker	.....	D9/557
D637,909 S *	5/2011	Fleischhacker	.....	D9/557
D648,222 S *	11/2011	Snyder	.....	D9/554
D699,580 S *	2/2014	Eaton	.....	D9/516

(Continued)

**FOREIGN PATENT DOCUMENTS**

MX	19042	10/2005
MX	20073	2/2006
MX	38633	5/2013

*Primary Examiner* — Dana Meyrow

(74) *Attorney, Agent, or Firm* — Sterne, Kessler, Goldstein & Fox P.L.L.C.

(57) **CLAIM**

The ornamental design for a bottle, as shown and described.

**DESCRIPTION**

FIG. 1 is a top perspective view of a bottle showing the claimed design;  
FIG. 2 is a bottom perspective view thereof;  
FIG. 3 is a front view thereof;  
FIG. 4 is a left side view thereof;  
FIG. 5 is a rear view thereof;  
FIG. 6 is a right side view thereof;  
FIG. 7 is a top view thereof; and,  
FIG. 8 is a bottom view thereof.  
The dashed broken lines in the figures show portions of the bottle that form no part of the claimed design.  
The dot-dash broken lines in the figures show boundaries that form no part of the claimed design.

**1 Claim, 7 Drawing Sheets**

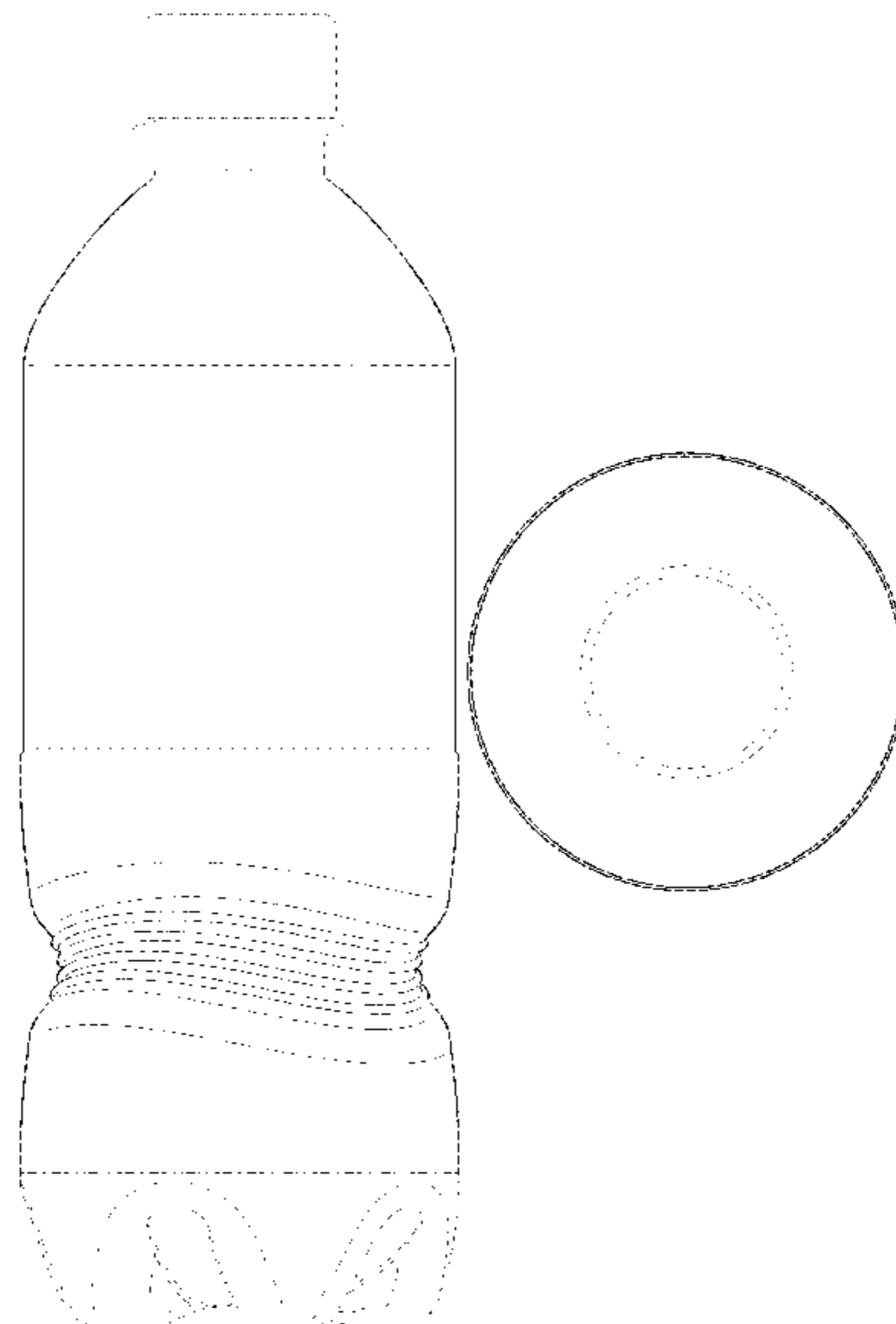

(56)

**References Cited**

U.S. PATENT DOCUMENTS

D700,519 S *	3/2014	Eaton	.....	D9/540
D719,449 S *	12/2014	Eaton	.....	D9/540
D736,628 S *	8/2015	Fleischhacker	.....	D9/500
D739,752 S *	9/2015	Eaton	.....	D9/540
D759,494 S *	6/2016	Hanan	.....	D9/520
D767,404 S *	9/2016	Eaton	.....	D9/552
D772,071 S *	11/2016	Eaton	.....	D9/540
D790,974 S *	7/2017	Hanan	.....	D9/552
D808,813 S *	1/2018	Moore	.....	D9/551
D871,222 S *	12/2019	Dabrowski	.....	D9/557
D885,192 S *	5/2020	Hall	.....	D6/556
D893,303 S *	8/2020	Cheng	.....	D9/540
D918,048 S *	5/2021	Cheng	.....	D9/540

\* cited by examiner

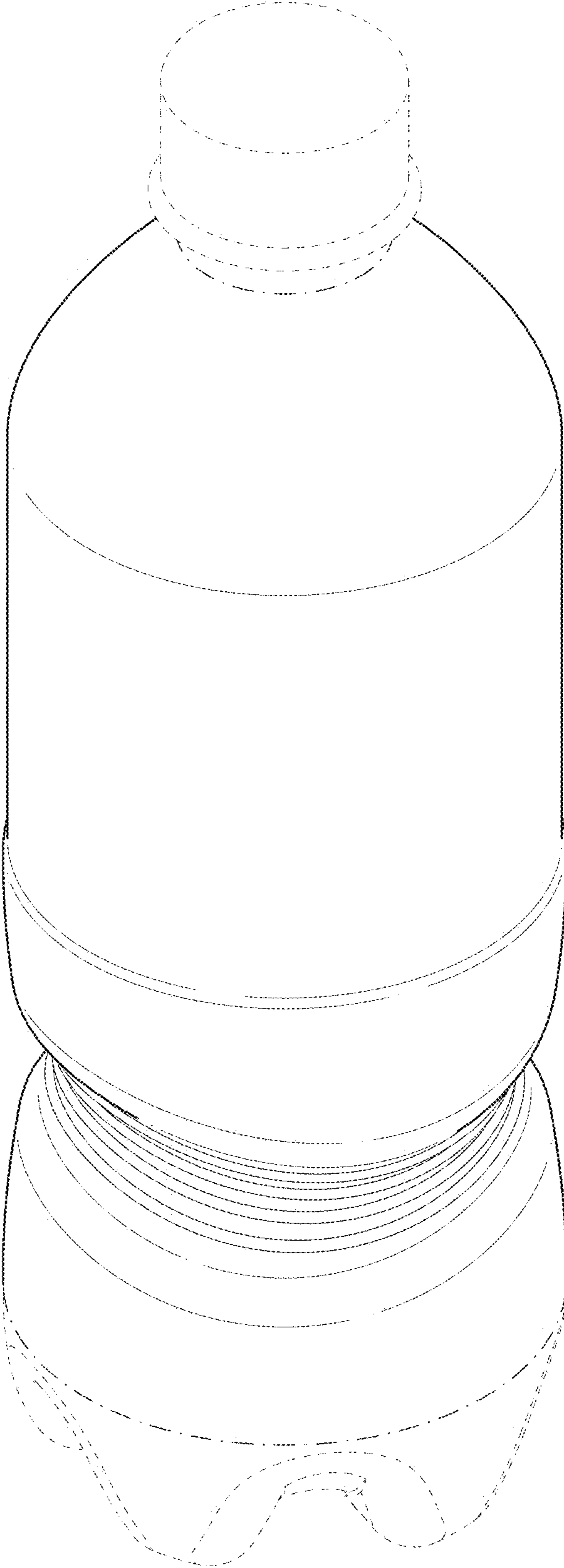

FIG. 1

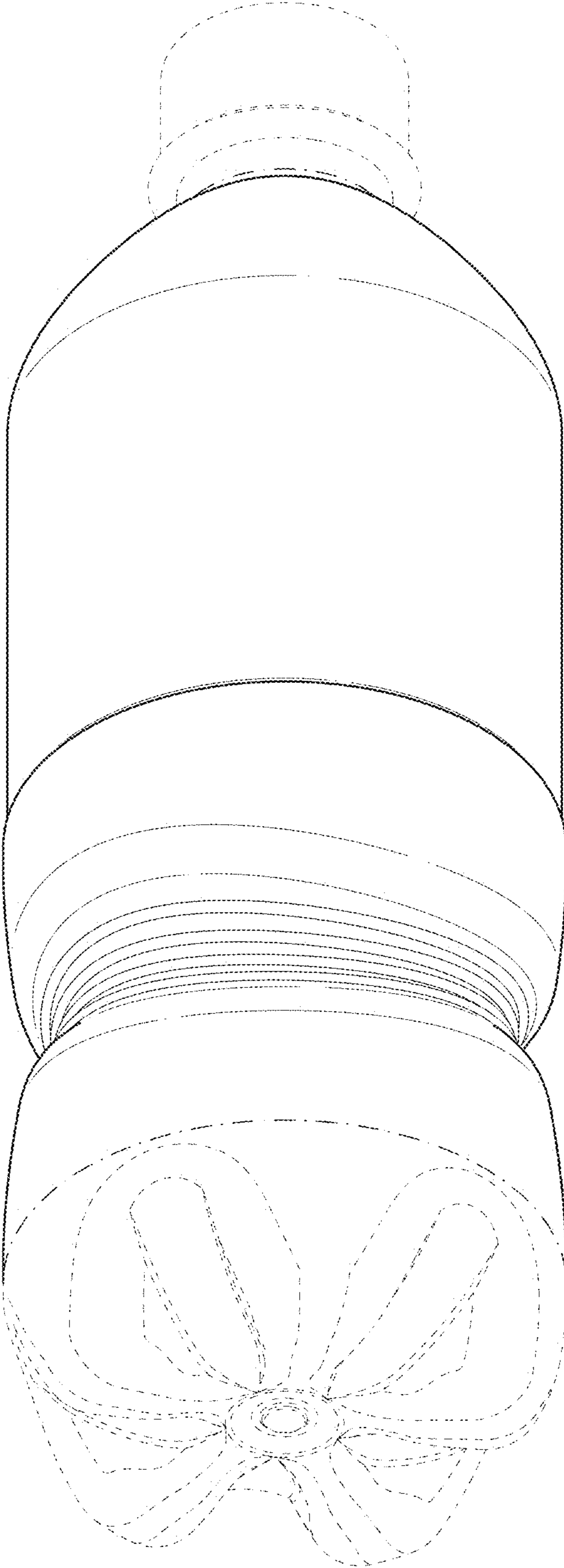
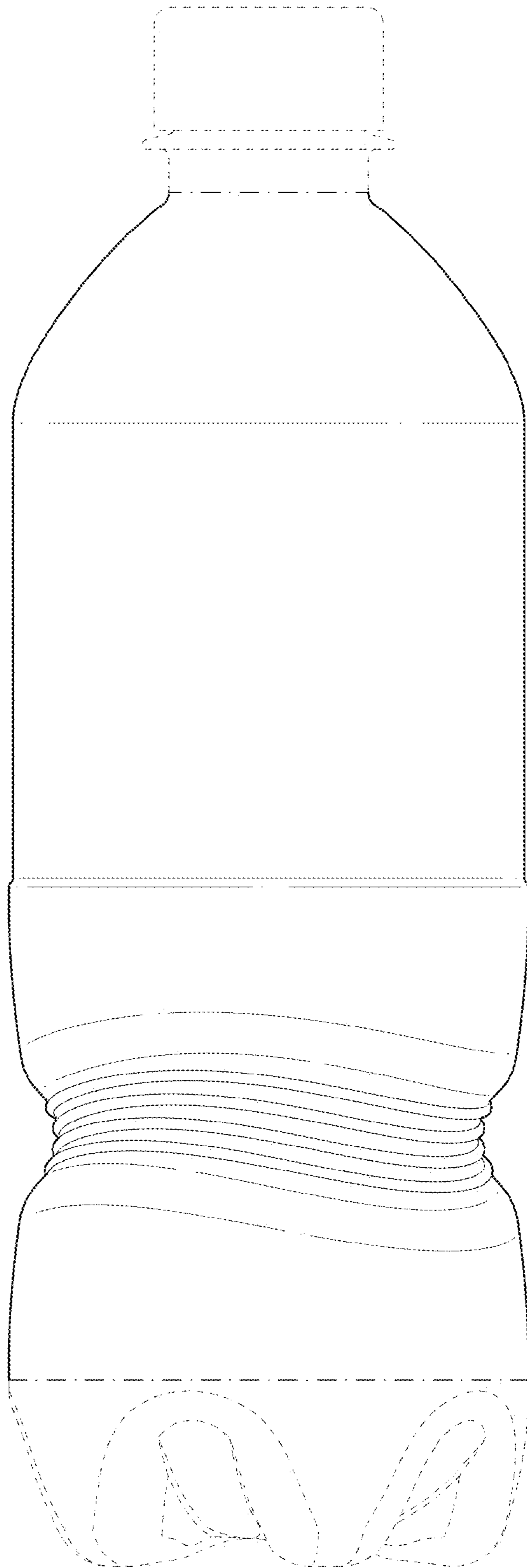
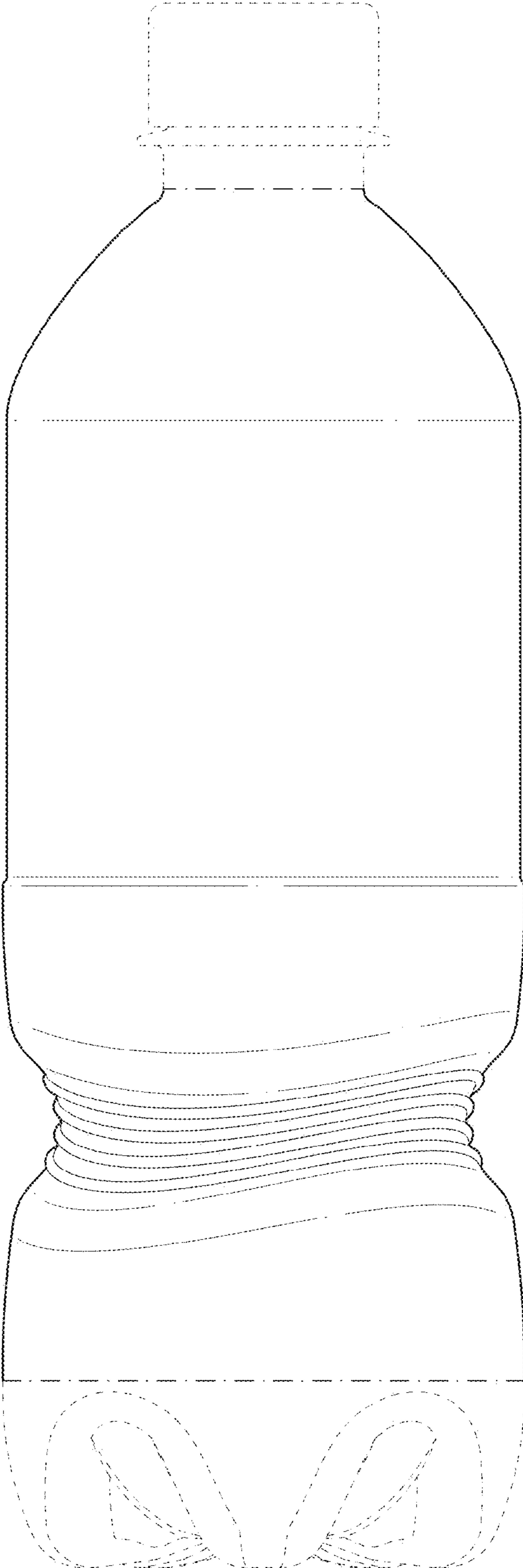

FIG. 2



**FIG. 3**



**FIG. 4**

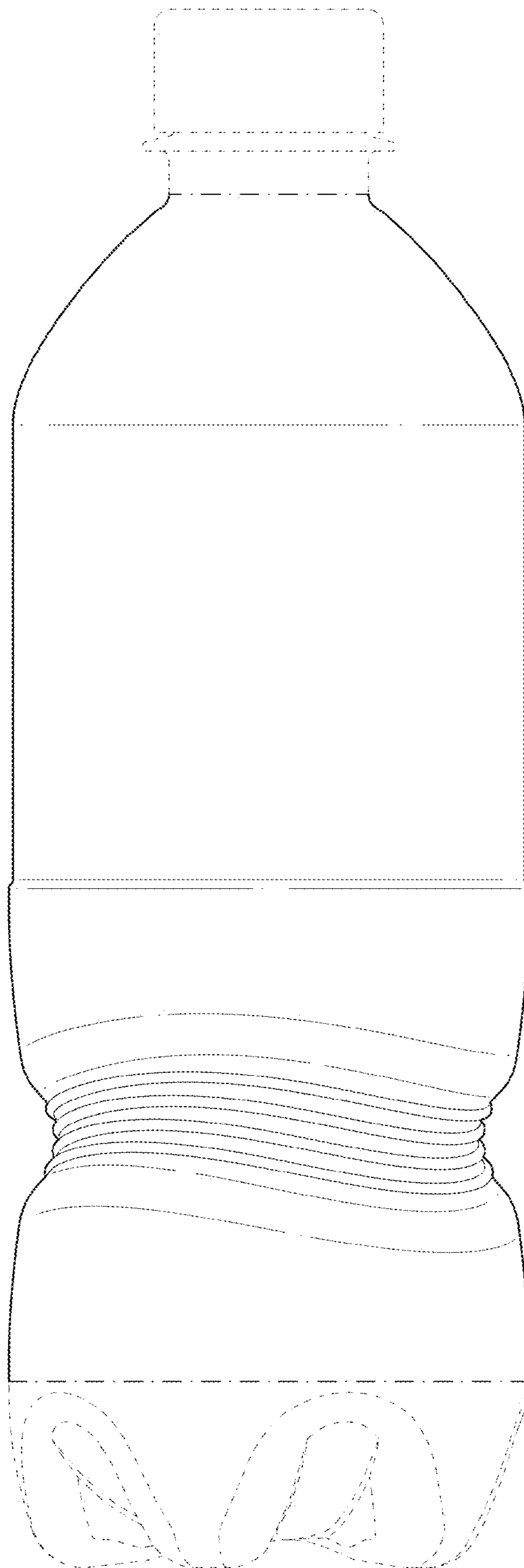
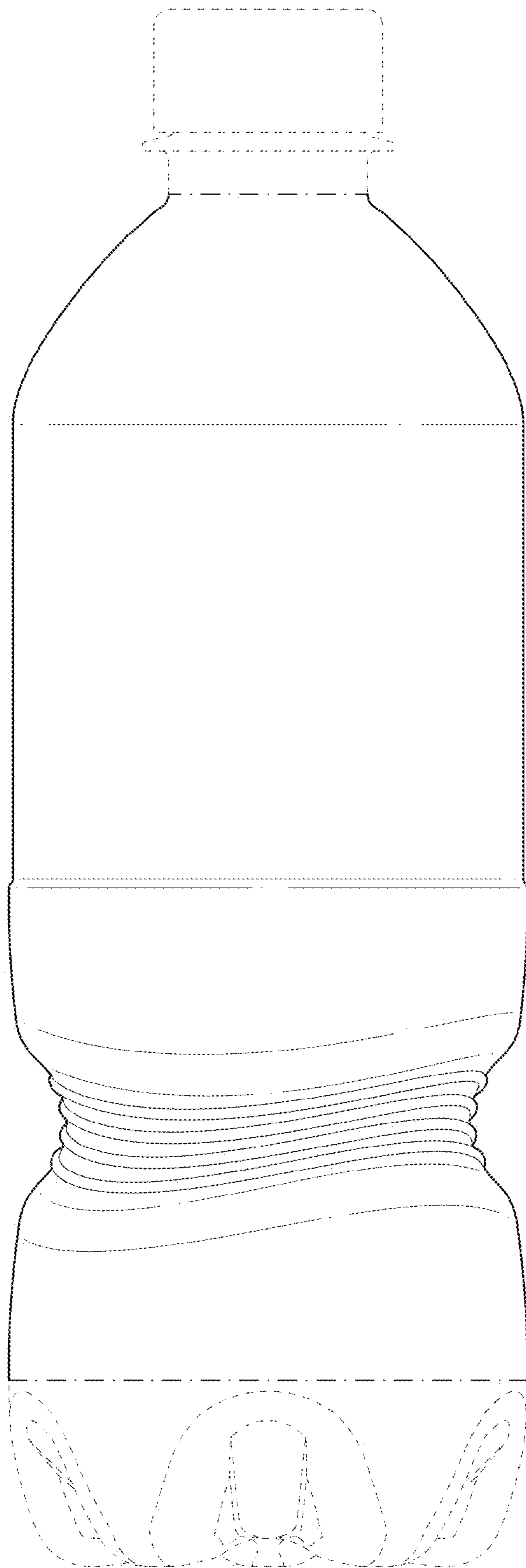
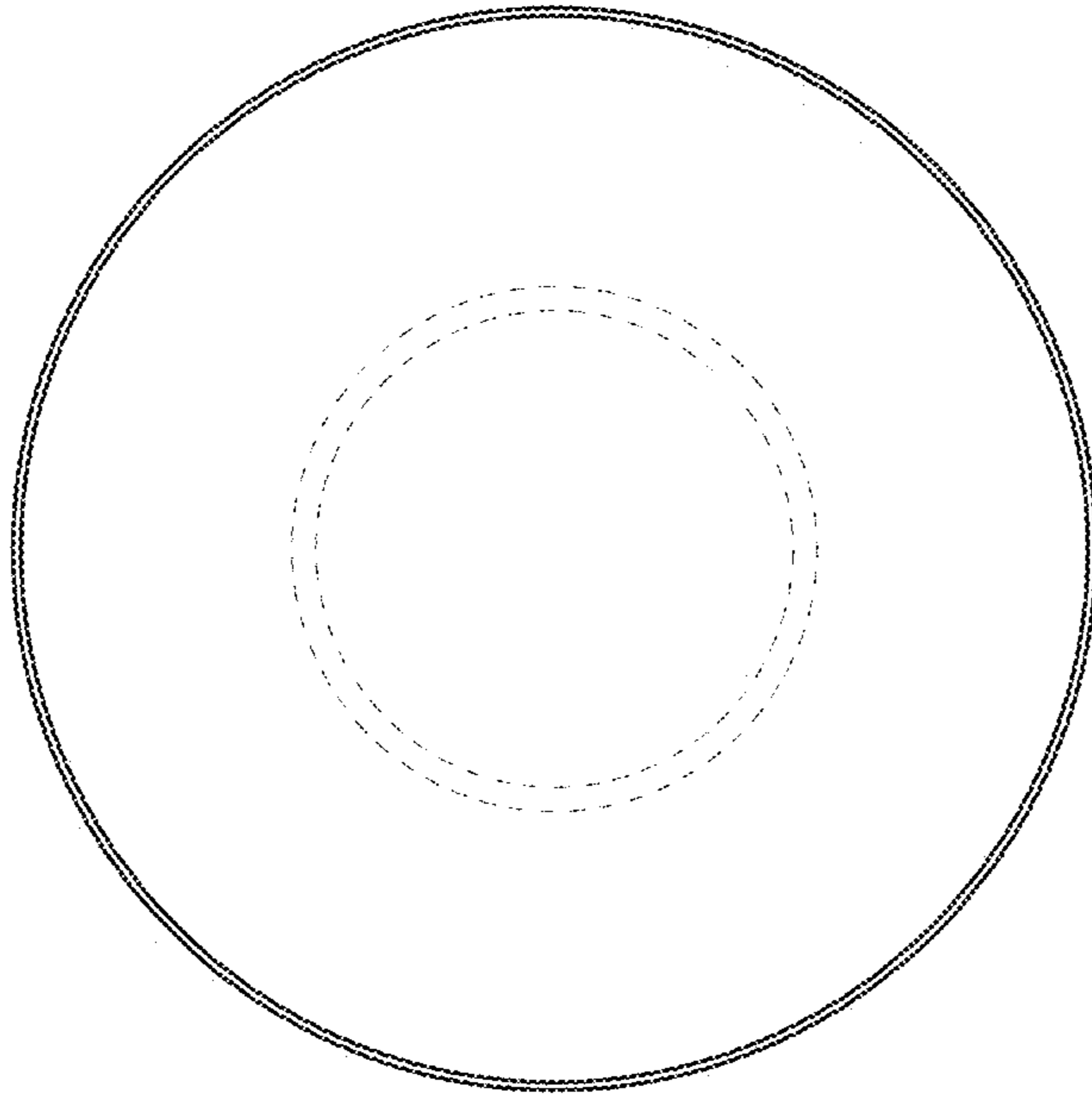

FIG. 5

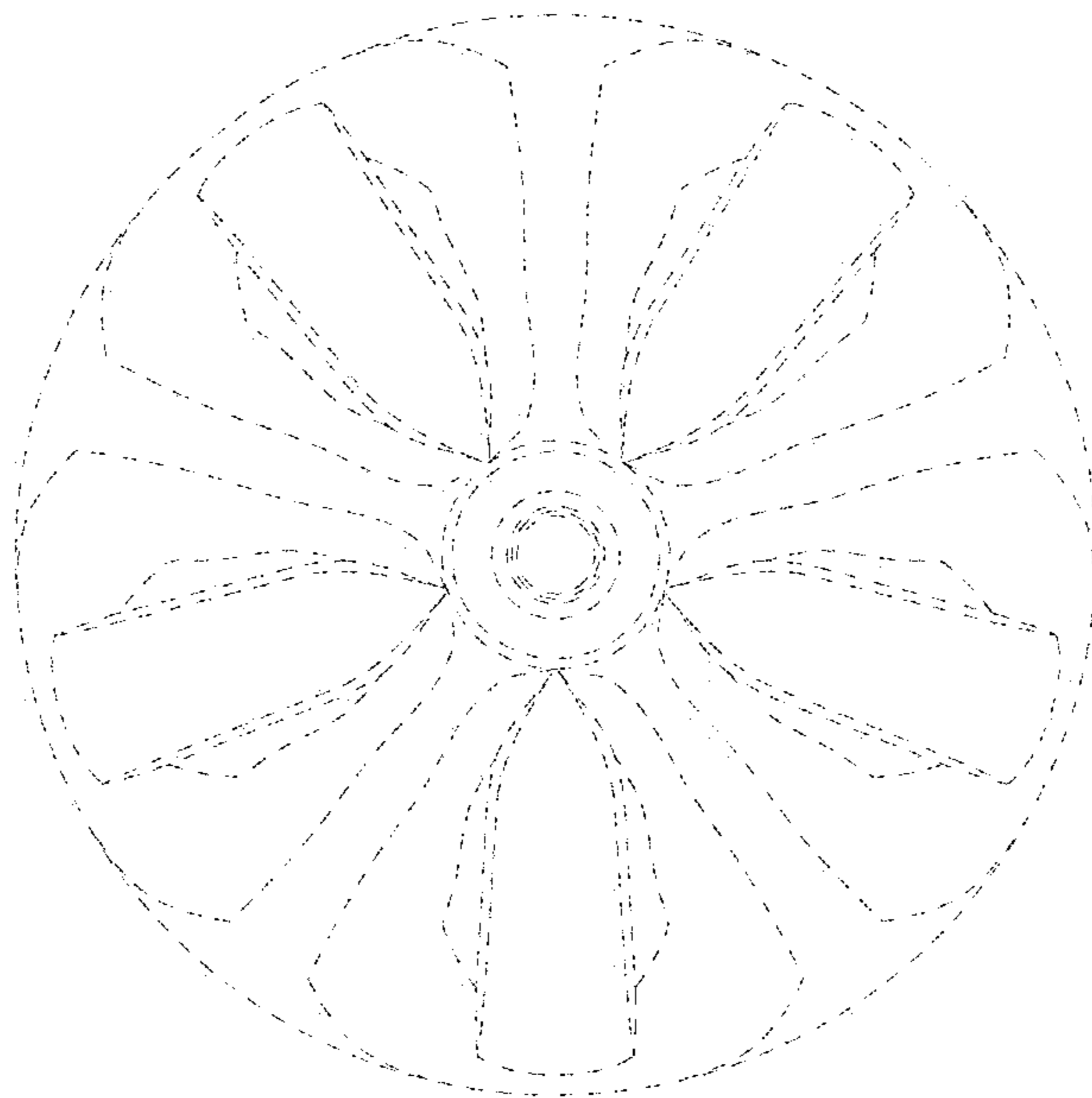

**FIG. 6**





**FIG. 7**



**FIG. 8**