



US00D965427S

(12) **United States Design Patent** (10) **Patent No.:** **US D965,427 S**
Kvam (45) **Date of Patent:** **** Oct. 4, 2022**

- (54) **PACKAGING CONTAINER**
- (71) Applicant: **Elopak AS**, Spikkestad (NO)
- (72) Inventor: **Gerd Unni Kvam**, Hokksund (NO)
- (**) Term: **15 Years**
- (21) Appl. No.: **35/509,782**
- (22) Filed: **Jan. 10, 2020**
- (80) **Hague Agreement Data**

Int. Filing Date: **Jan. 10, 2020**
 Int. Reg. No.: **DM/206837**
 Int. Reg. Date: **Jan. 10, 2020**
 Int. Reg. Pub. Date: **Jul. 10, 2020**

- (51) **LOC (13) Cl.** **09-07**
- (52) **U.S. Cl.**
USPC **D9/433**

- (58) **Field of Classification Search**
USPC D9/414, 416-417, 429, 430-433
CPC B65D 5/067; B65D 2571/0066; B65D
5/4266; B65D 15/22; B65D 2571/0029;
B65D 75/5855; B65D 77/065; B65D
5/708
See application file for complete search history.

(56) **References Cited**
U.S. PATENT DOCUMENTS

2,738,916 A * 3/1956 Peters B65D 5/708
229/125.05
4,781,323 A * 11/1988 Elias B65D 5/065
220/255.1
5,556,026 A * 9/1996 Blankitny B65D 5/0236
229/123.1
5,938,107 A * 8/1999 Anchor B65D 5/064
229/109
D717,167 S * 11/2014 Stone D9/433
D717,647 S * 11/2014 De Pietri Tonelli D9/433
D720,214 S * 12/2014 De Pietri Tonelli D9/433
D721,957 S * 2/2015 Scales D9/433

2008/0240628 A1 * 10/2008 VanLoocke B65D 75/5855
383/210
2010/0012711 A1 * 1/2010 Paulen B65D 5/029
229/248
2015/0102095 A1 * 4/2015 Wong B31B 50/88
229/125.42
2015/0166215 A1 * 6/2015 DiRico B65D 5/708
229/123.1
2017/0073102 A1 * 3/2017 Borasi B65B 3/025
2019/0047744 A1 * 2/2019 Dahan B65D 5/4275
2020/0207055 A1 * 7/2020 Wirtz B65B 3/04
2020/0216247 A1 * 7/2020 Barran B65D 75/5838
2020/0317390 A1 * 10/2020 Leufstedt B65D 5/064
2021/0147110 A1 * 5/2021 Nakamura B65D 5/4266
2021/0178348 A1 * 6/2021 Sasso B65D 5/48016

* cited by examiner

Primary Examiner — Michael A. Pratt

(57) **CLAIM**

The ornamental design for a packaging container, as shown and described.

DESCRIPTION

- 2. Packaging container
- 4. Packaging container
- 2.1 : Perspective
- 2.2 : Back
- 2.3 : Front
- 2.4 : Left
- 2.5 : Right
- 2.6 : Top
- 2.7 : Bottom
- 4.1 : Perspective
- 4.2 : Back
- 4.3 : Front
- 4.4 : Left
- 4.5 : Right
- 4.6 : Top
- 4.7 : Bottom
- Packaging container

1 Claim, 14 Drawing Sheets

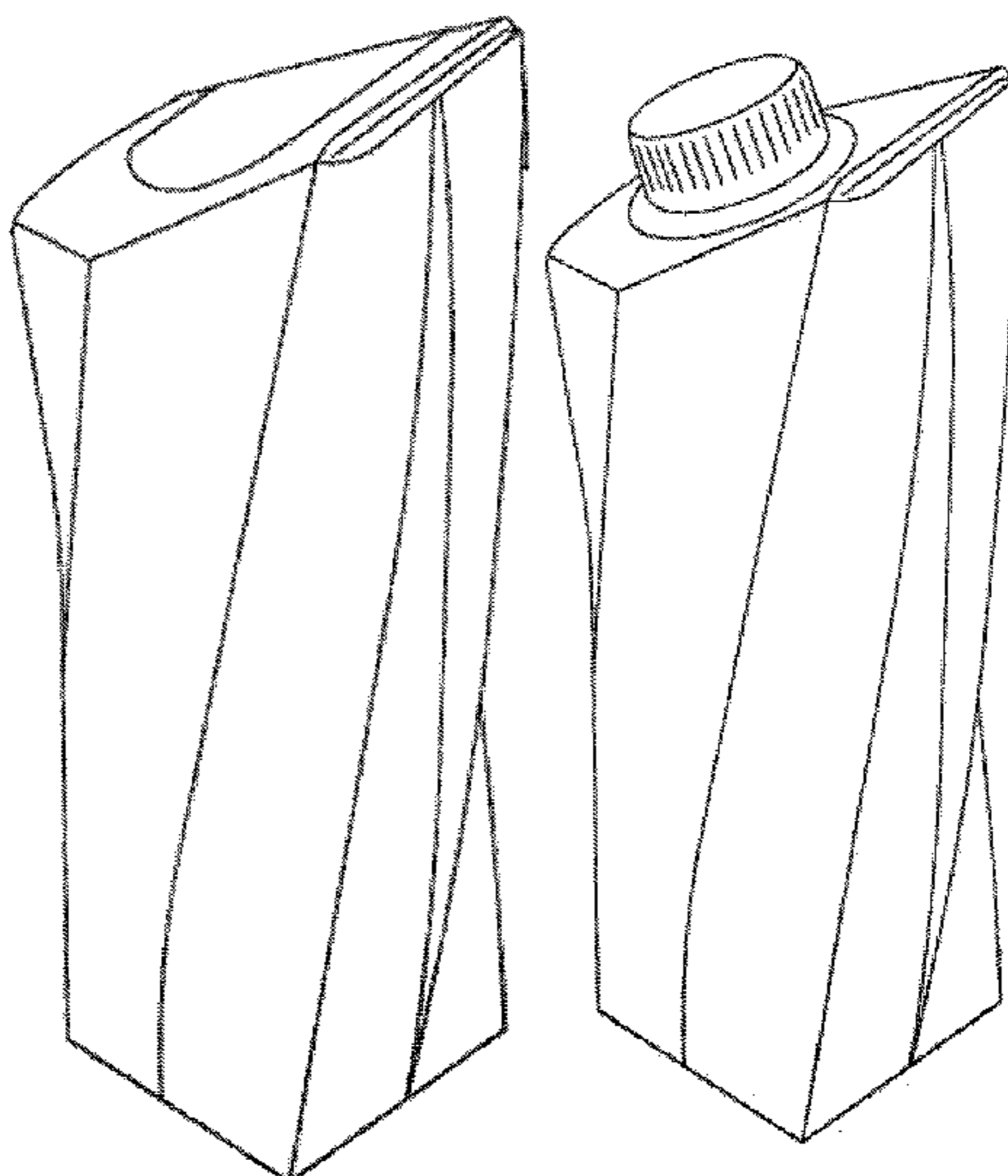

2.1

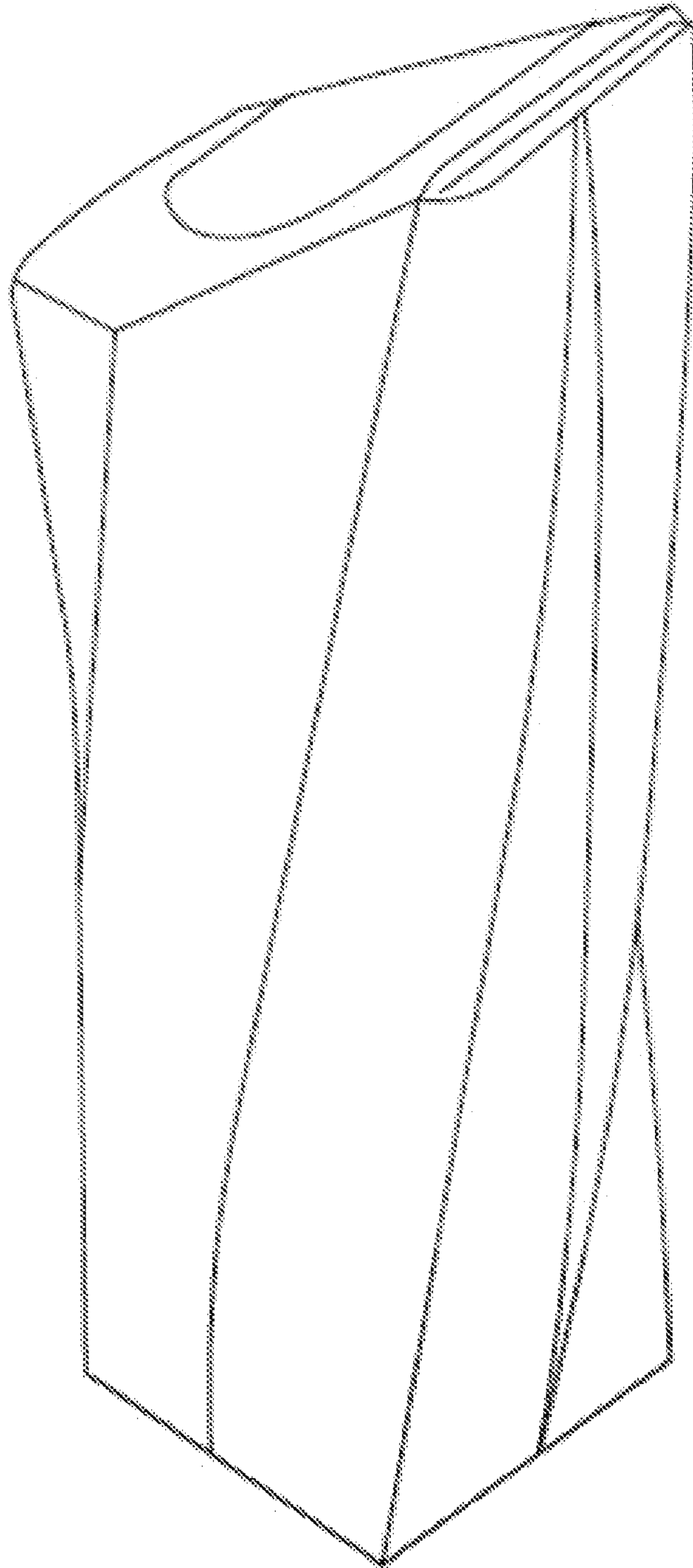

2.2

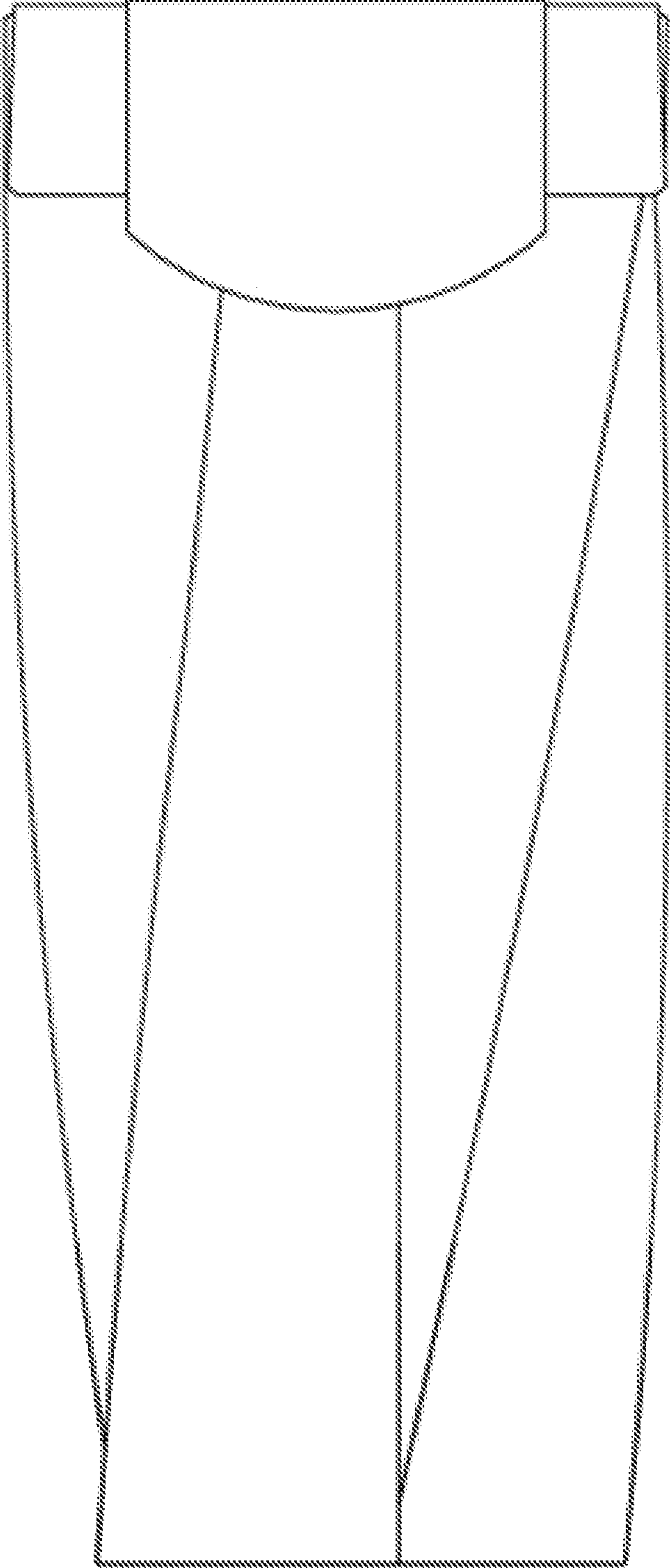

2.3

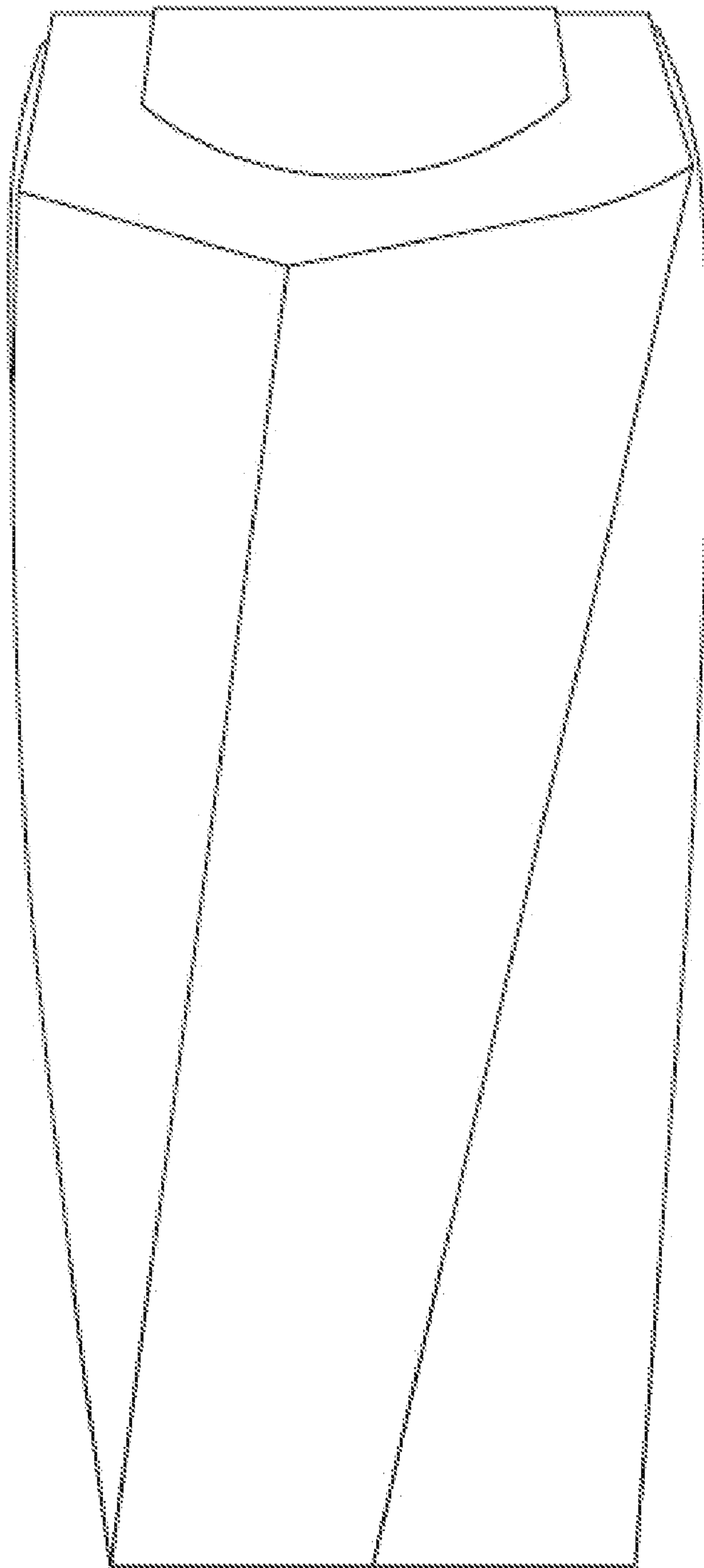

2.4

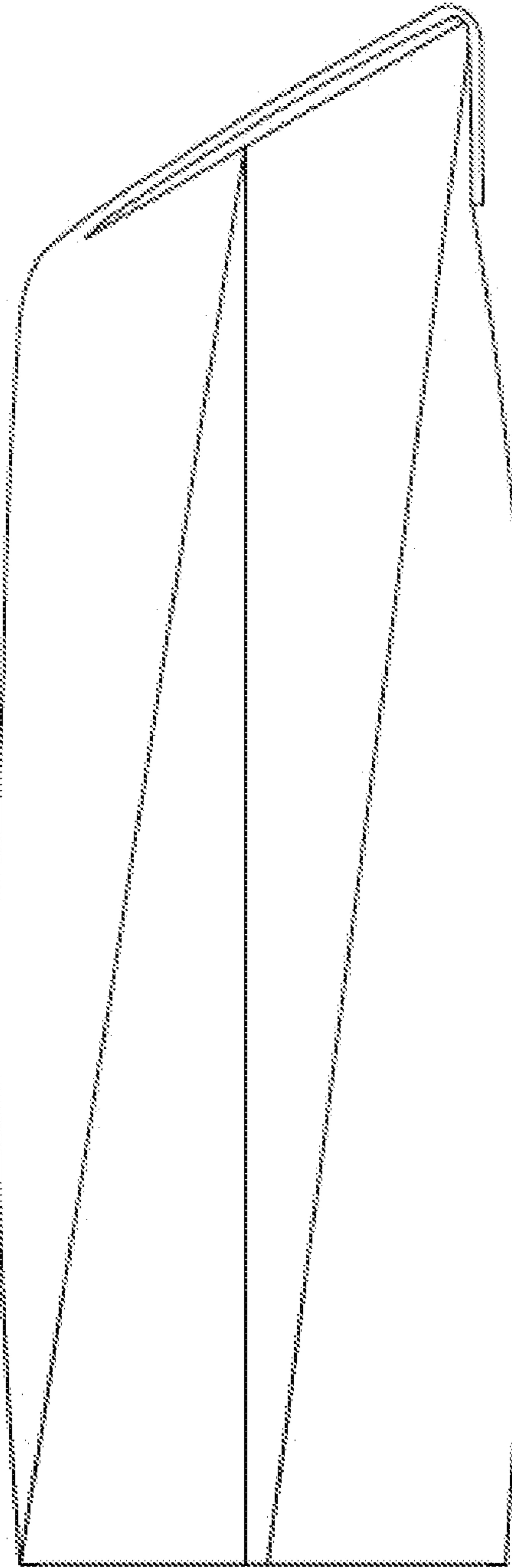

2.5

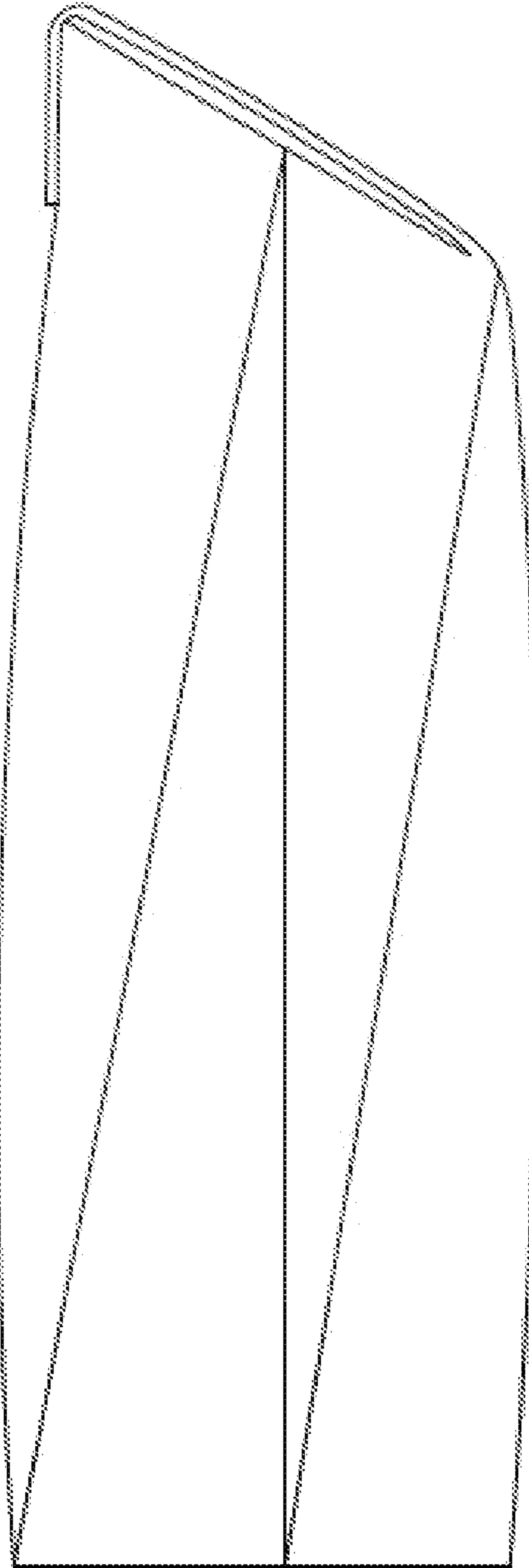

2.6

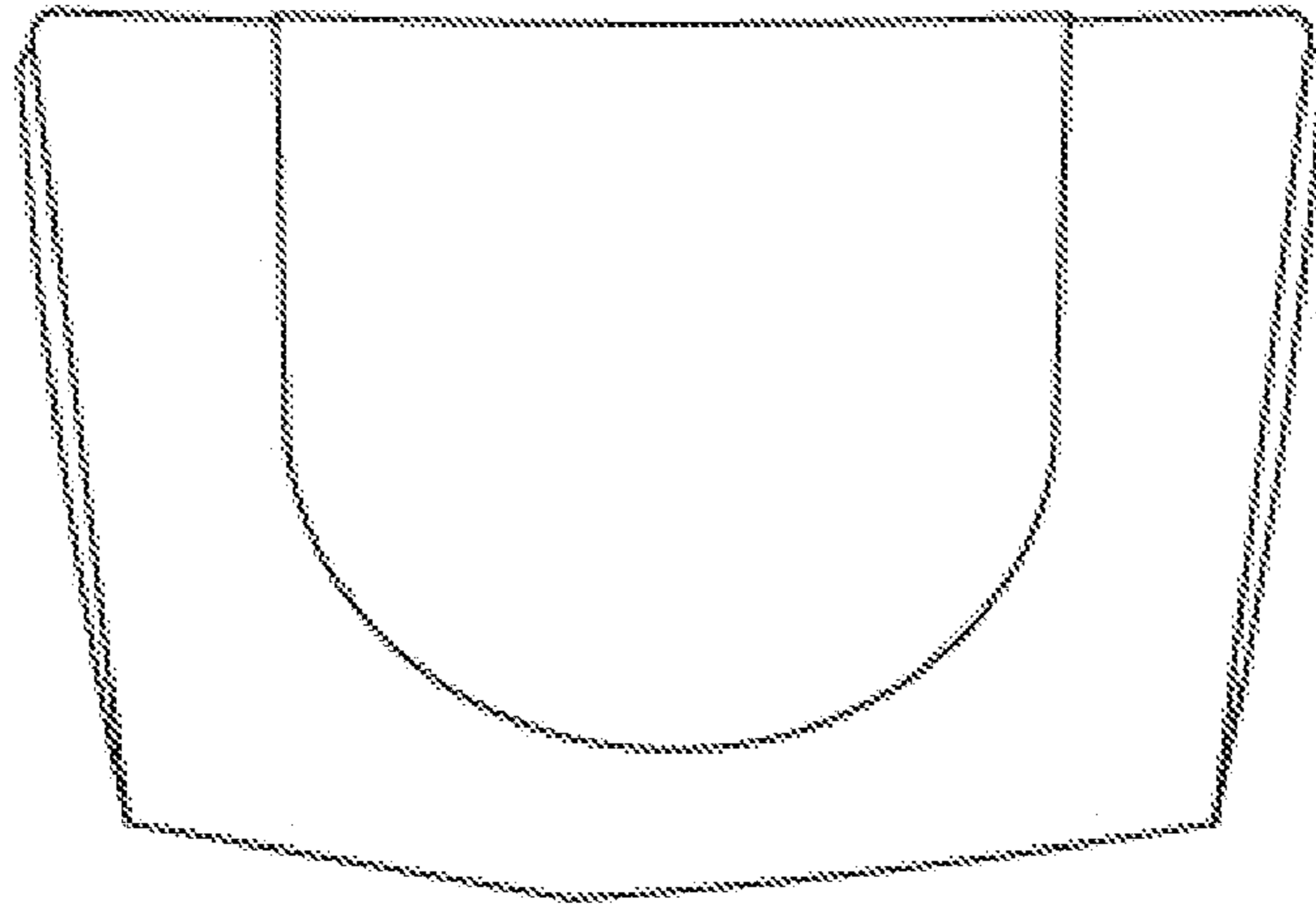

2.7

4.1

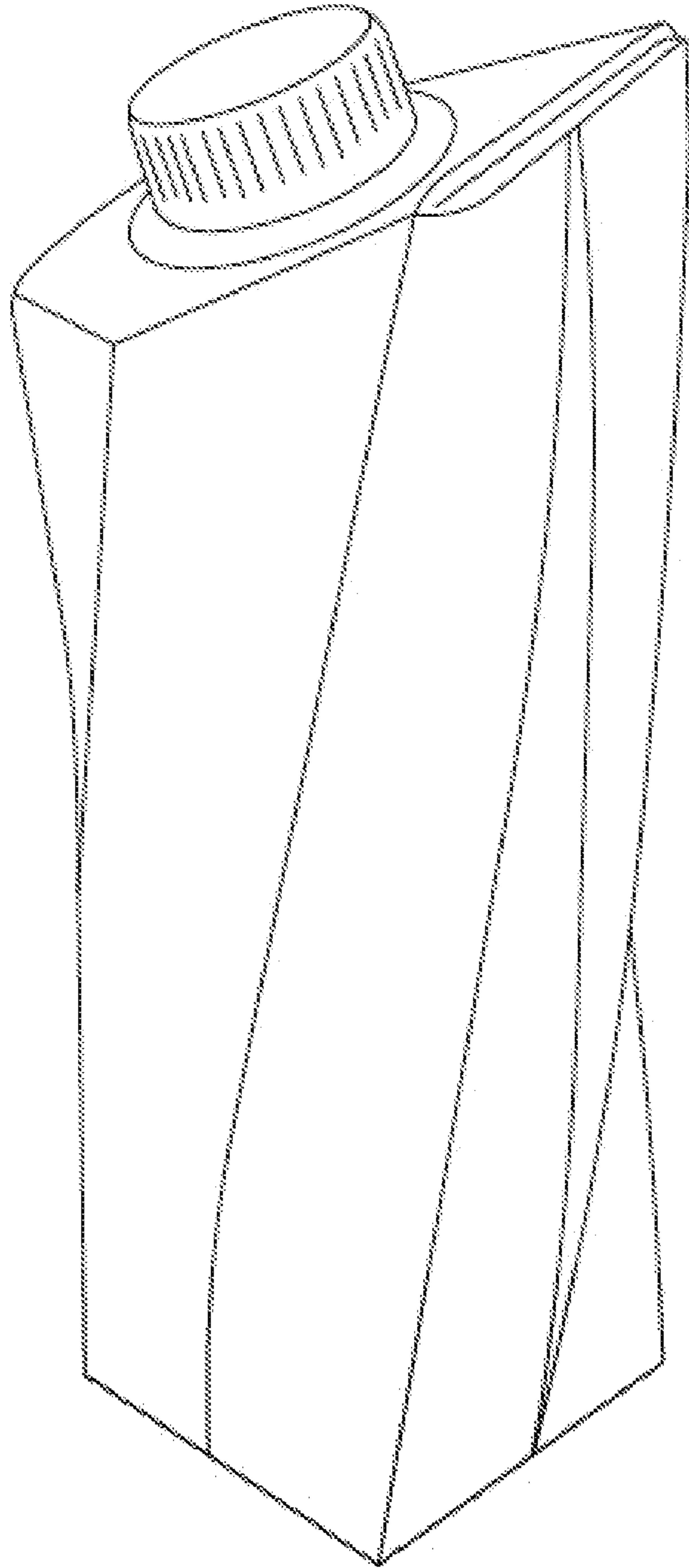

4.2

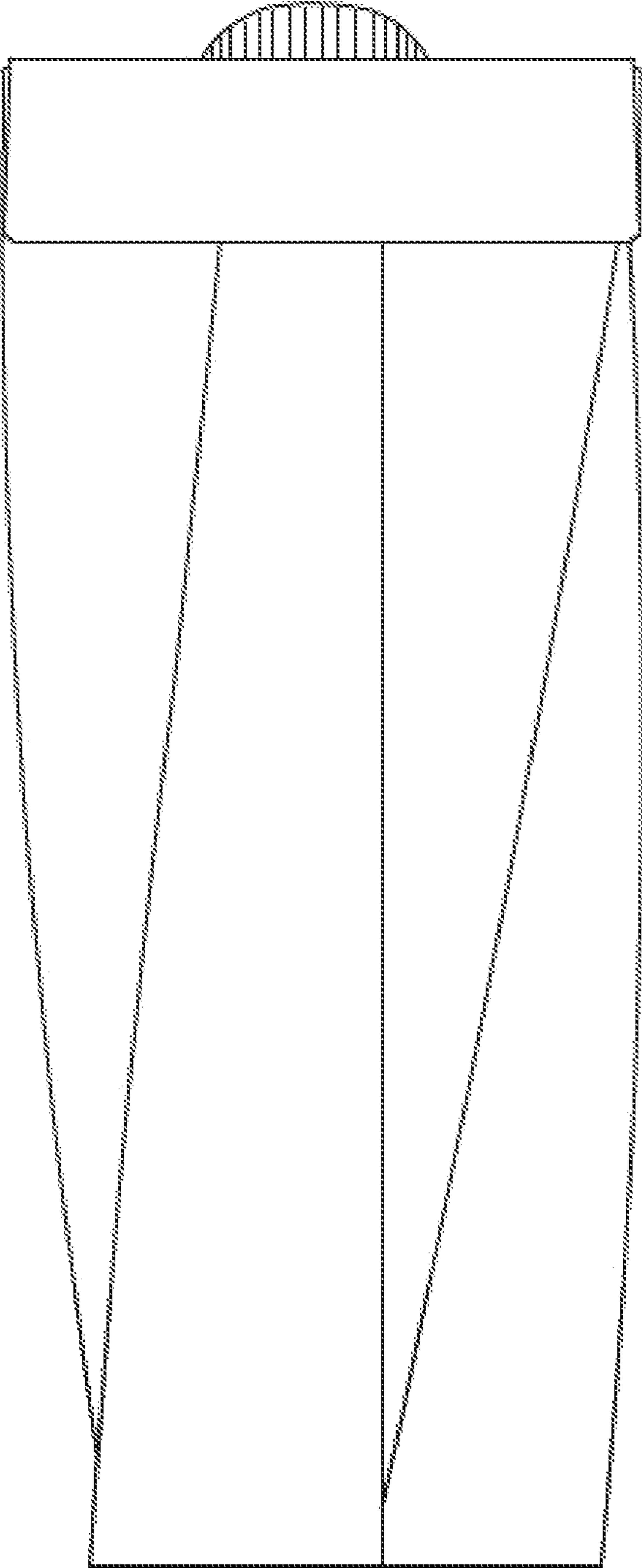

4.3

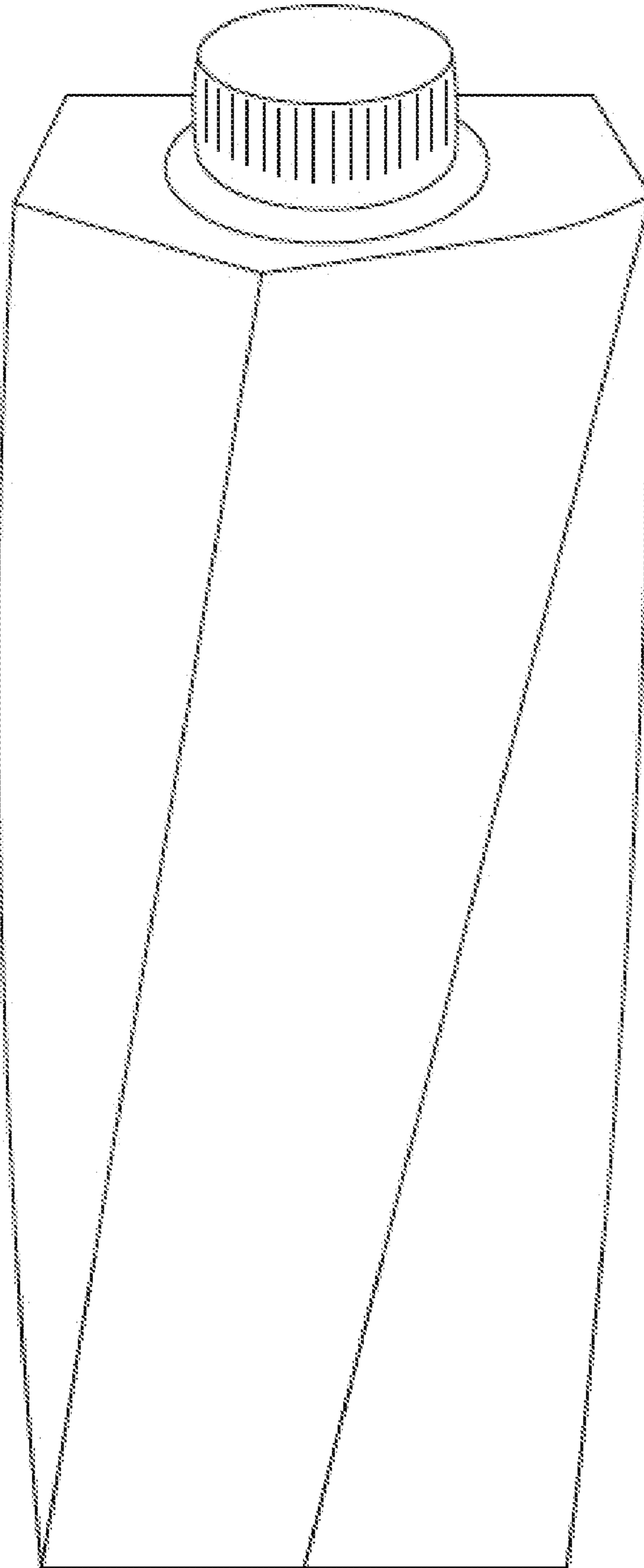

4.4

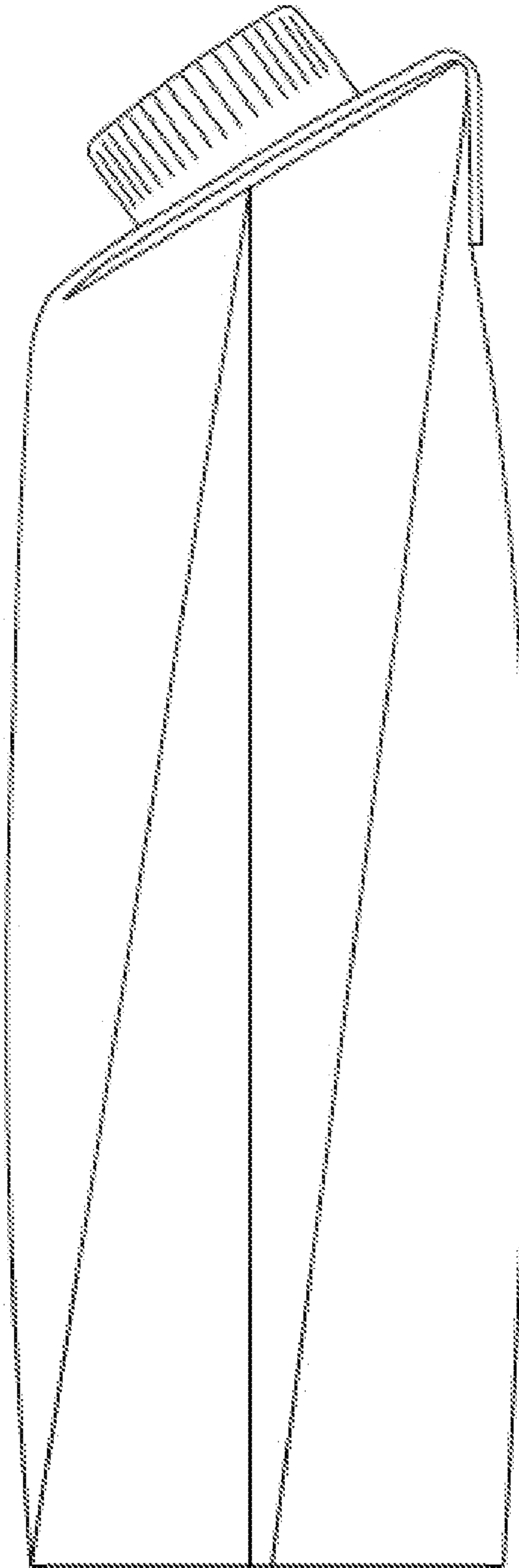

4.5

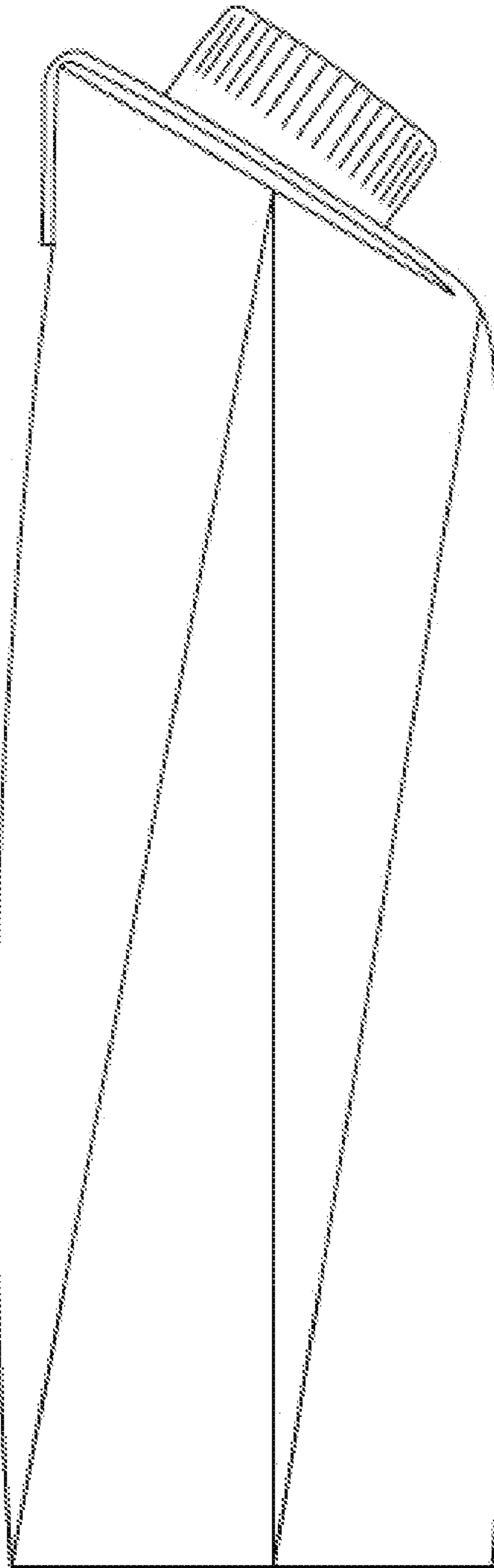

4.6

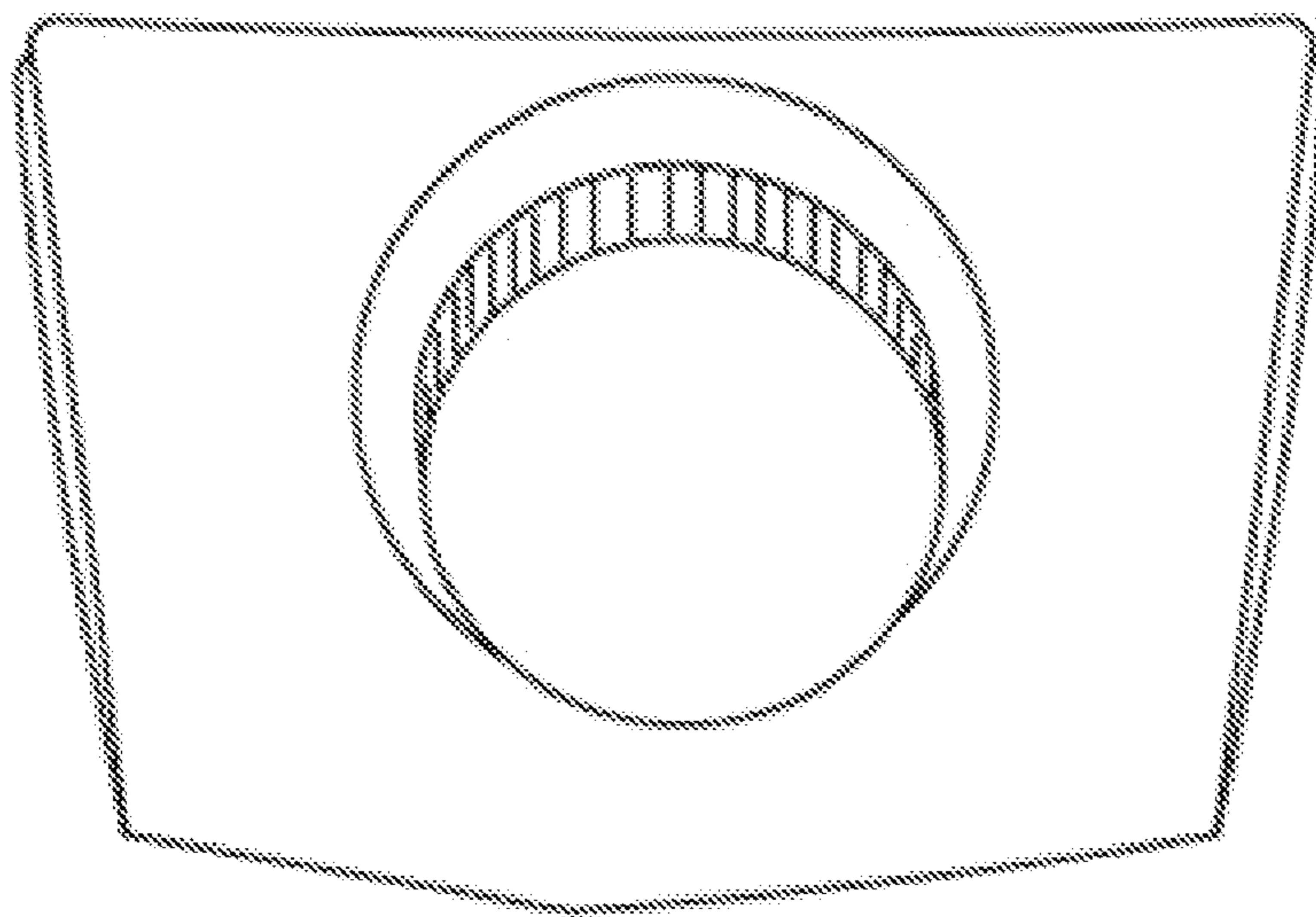

4.7
