



US00D965363S

(12) **United States Design Patent**
Cheng

(10) **Patent No.:** **US D965,363 S**

(45) **Date of Patent:** **** Oct. 4, 2022**

- (54) **JEWELRY RACK**
- (71) Applicant: **Tao Cheng**, Nanchang (CN)
- (72) Inventor: **Tao Cheng**, Nanchang (CN)
- (**) Term: **15 Years**
- (21) Appl. No.: **29/819,409**
- (22) Filed: **Dec. 15, 2021**
- (51) **LOC (13) Cl.** **06-06**
- (52) **U.S. Cl.**
USPC **D6/682.4**
- (58) **Field of Classification Search**
USPC ... D6/672-673, 675, 675.1, 677, 677.1, 680,
D6/680.1, 680.2, 682, 682.3, 682.4;
D28/73
CPC A47F 5/00; A47F 5/006; A47F 5/0018;
A47F 5/0043; A47F 7/00; A47F 7/02;
A47F 5/02; A47F 5/0087
See application file for complete search history.

D382,420 S *	8/1997	Woodward	D6/680.2
D385,130 S *	10/1997	Woodward	D6/680.2
5,794,782 A *	8/1998	Ascik	A47F 11/04 206/730
D401,083 S *	11/1998	Woodward	D6/680
D408,654 S *	4/1999	Liberto	D6/680
D436,265 S *	1/2001	Kidd	D6/680.2
D572,041 S *	7/2008	Woolnough	D6/680.2
D612,633 S *	3/2010	Mason	D6/680
D630,800 S *	1/2011	Greiner	D28/73
D658,417 S	5/2012	Kusmer et al.		
D793,120 S	8/2017	Bullard		
D802,965 S *	11/2017	Curran, Jr.	D6/662.1
D878,832 S *	3/2020	Cohen	D6/677
D939,257 S *	12/2021	Lin	D6/682.4
D955,646 S *	6/2022	Zhuo	D3/901

* cited by examiner

Primary Examiner — Kelley A Donnelly

(57) **CLAIM**

The ornamental design for a jewelry rack, as shown and described.

DESCRIPTION

FIG. 1 is a perspective view of a jewelry rack showing my new design;
 FIG. 2 is another perspective view thereof;
 FIG. 3 is a front elevational view thereof;
 FIG. 4 is a rear elevational view thereof;
 FIG. 5 is a left side elevational view thereof;
 FIG. 6 is a right side elevational view thereof;
 FIG. 7 is a top plan view thereof; and,
 FIG. 8 is a bottom plan view thereof.

1 Claim, 8 Drawing Sheets

(56) **References Cited**

U.S. PATENT DOCUMENTS

D233,380 S *	10/1974	Hyman	D6/675.2
4,322,007 A *	3/1982	Feibelman	A47F 7/02 211/85.2
4,850,658 A *	7/1989	Sandor	A47F 5/02 211/85.2
D322,368 S *	12/1991	Blum	D6/680
D333,929 S *	3/1993	Sandor	D6/680.2
5,335,985 A *	8/1994	Baur	G11B 15/6825
D367,384 S *	2/1996	DiFranco	D6/682.4
D376,492 S *	12/1996	Wang	D6/660

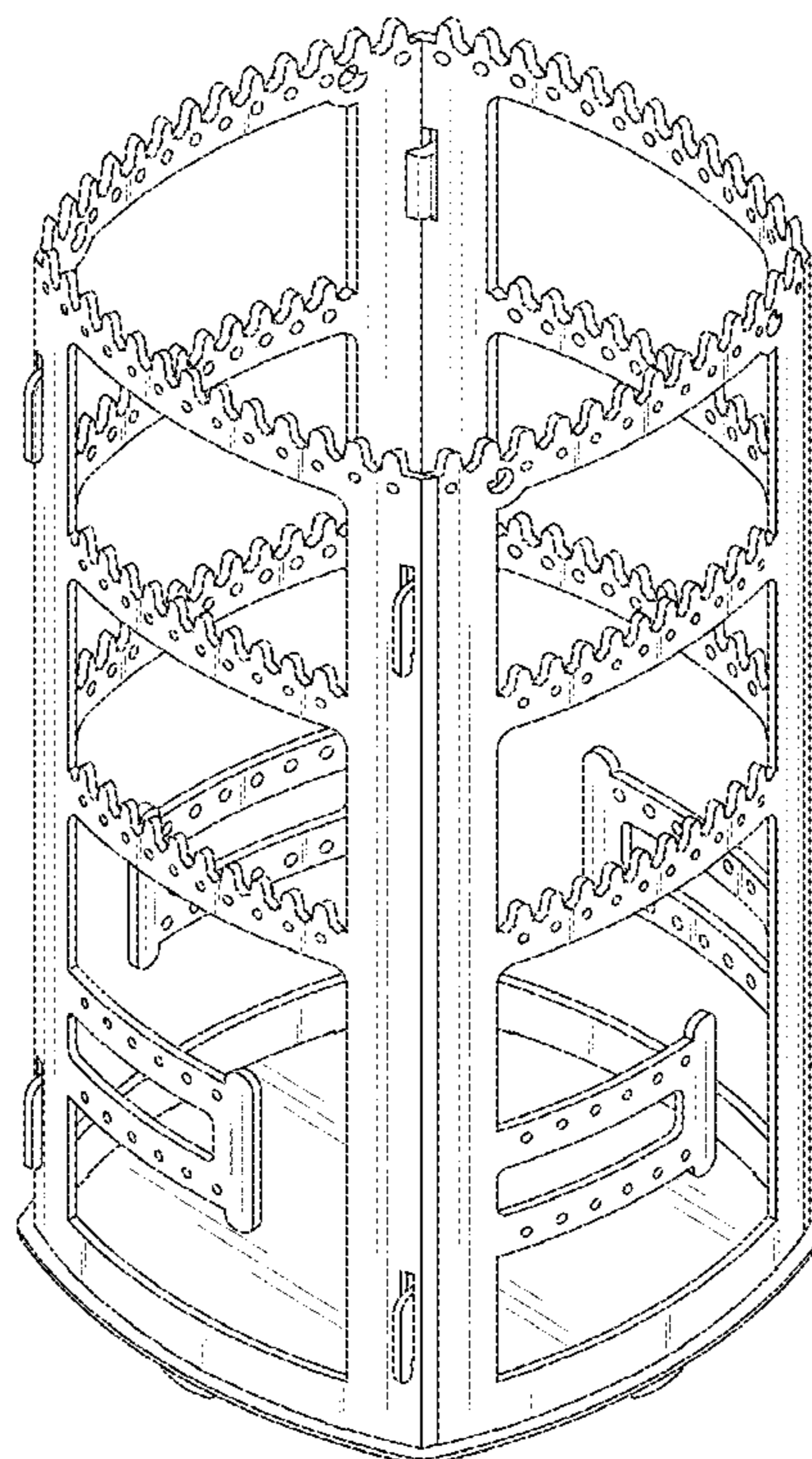

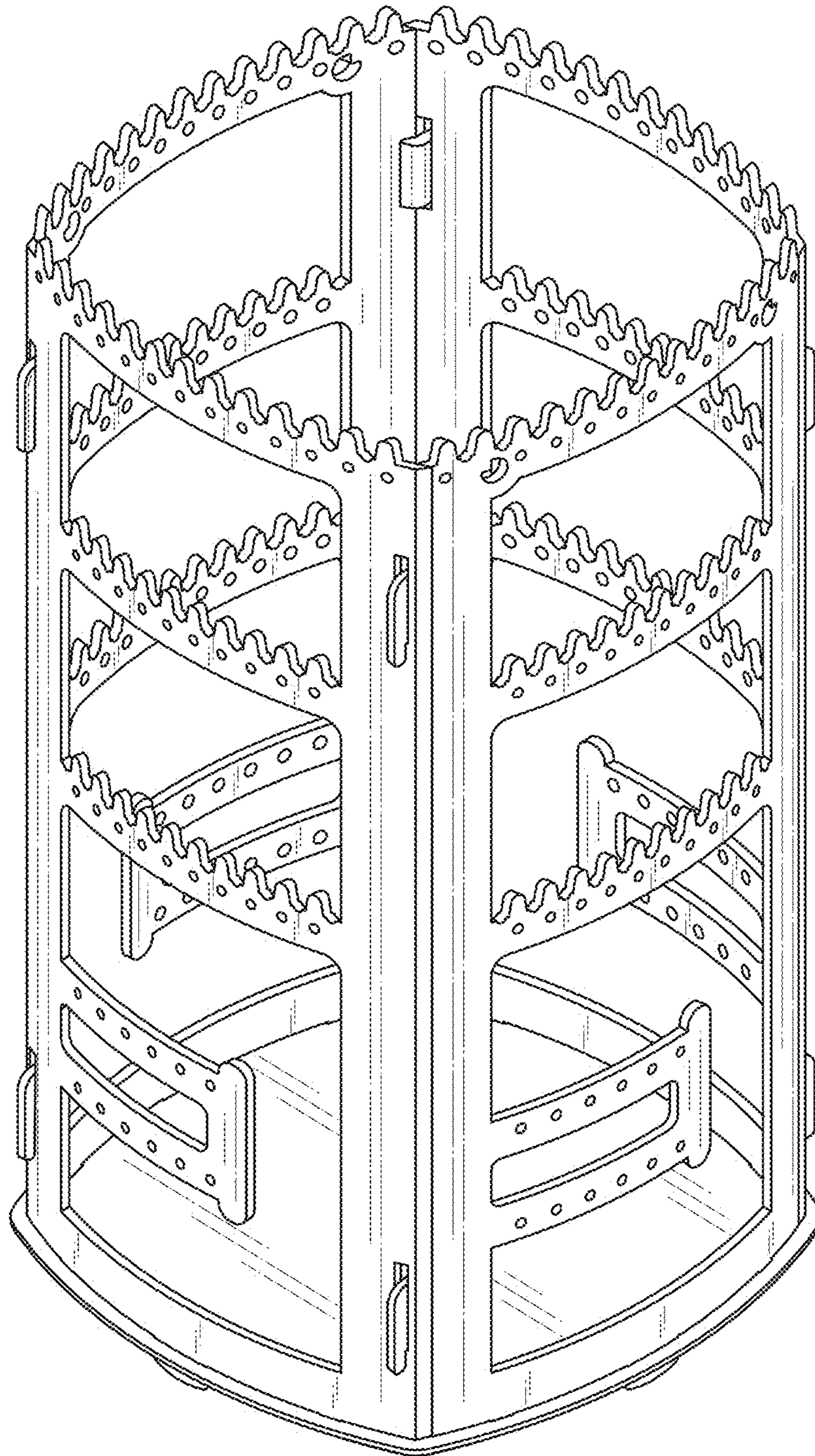

FIG. 1

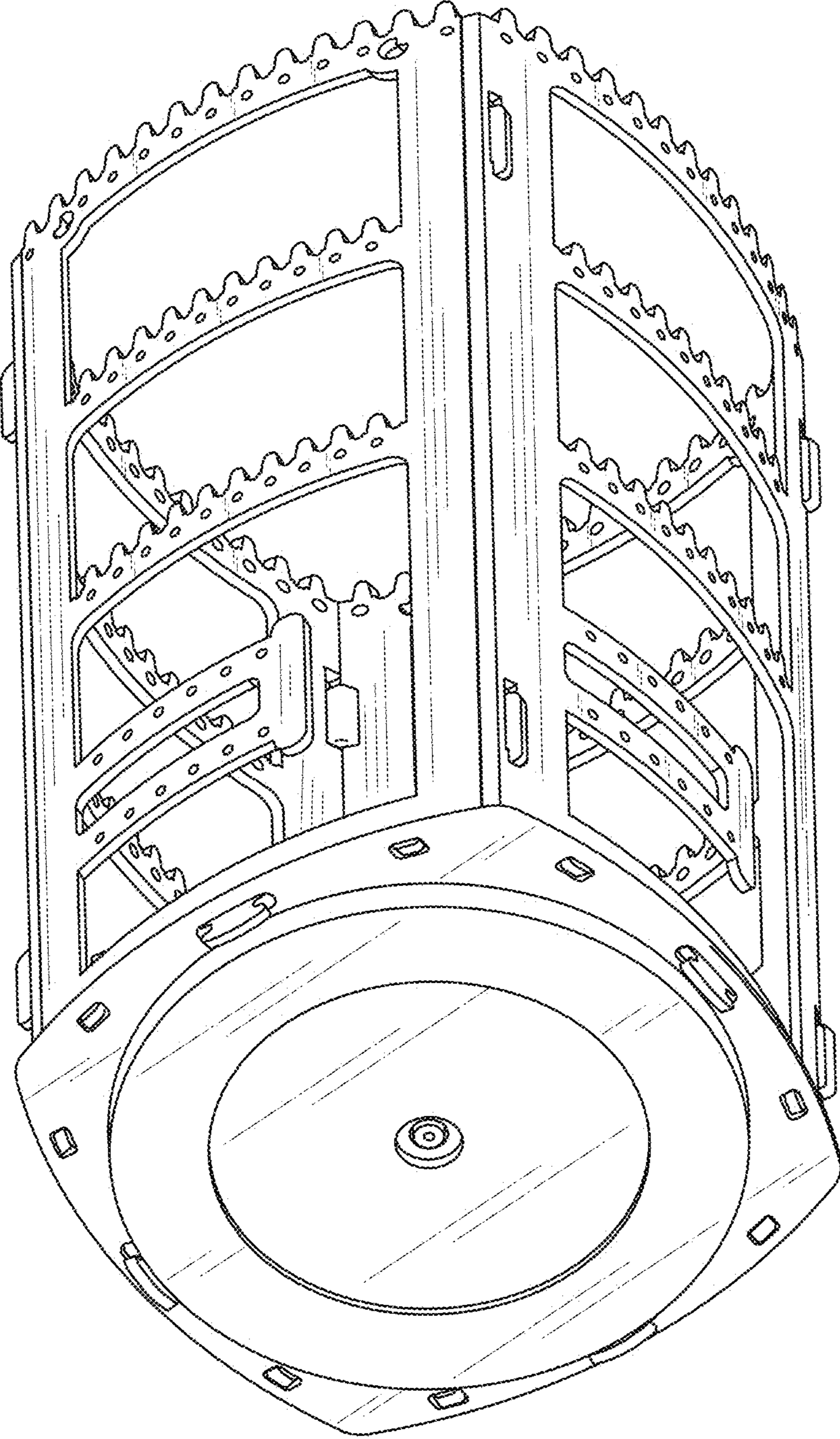

FIG.2

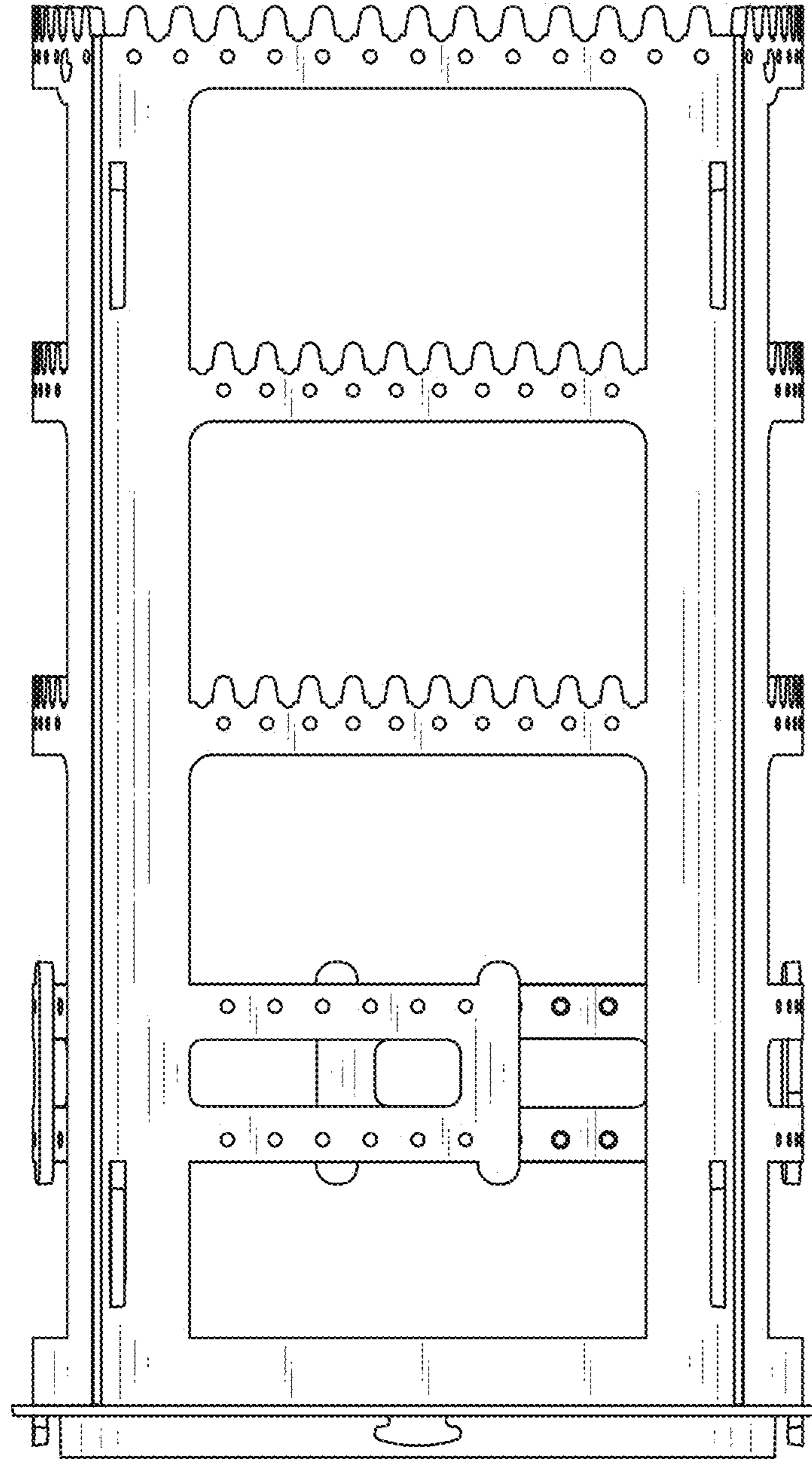

FIG.3

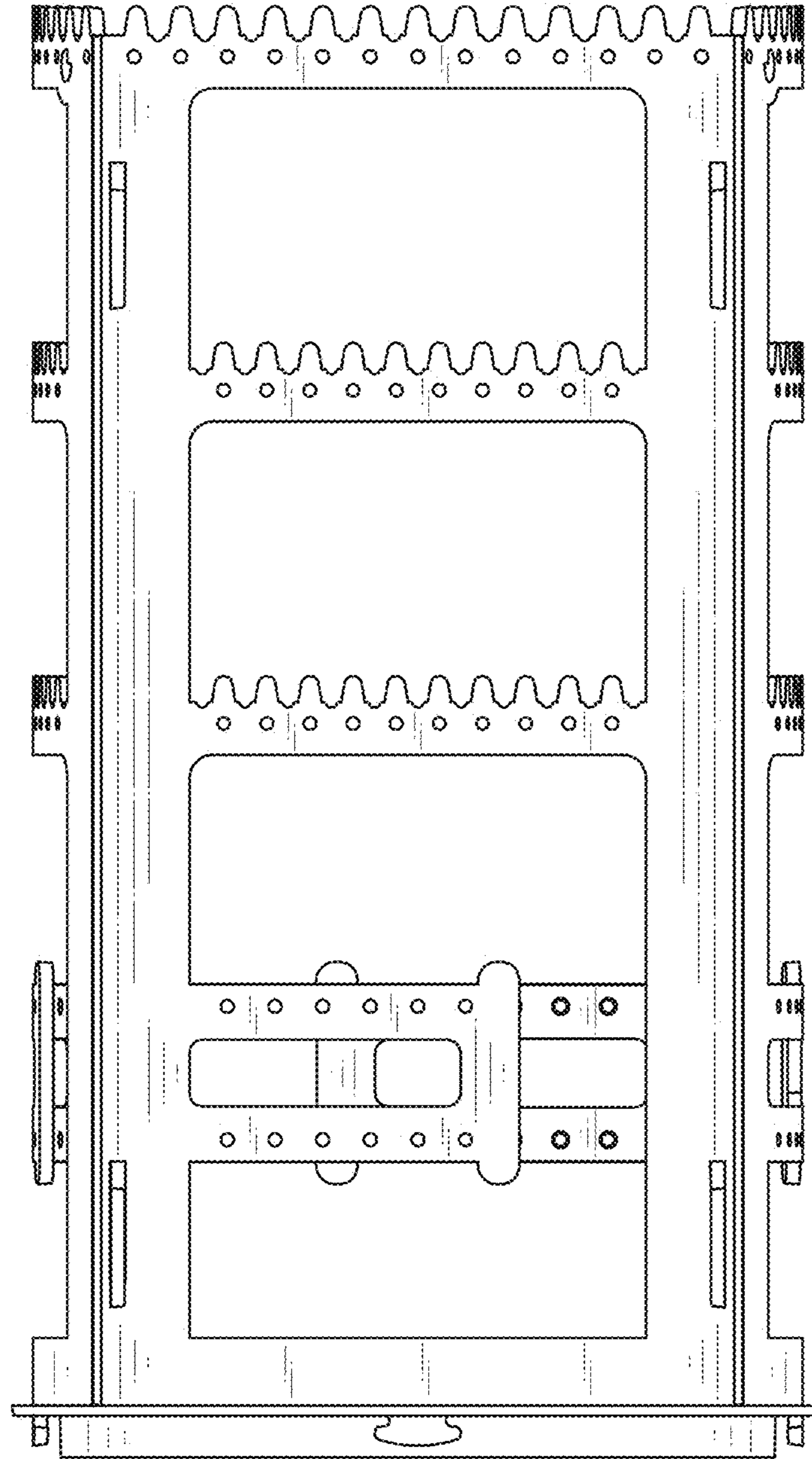

FIG.4

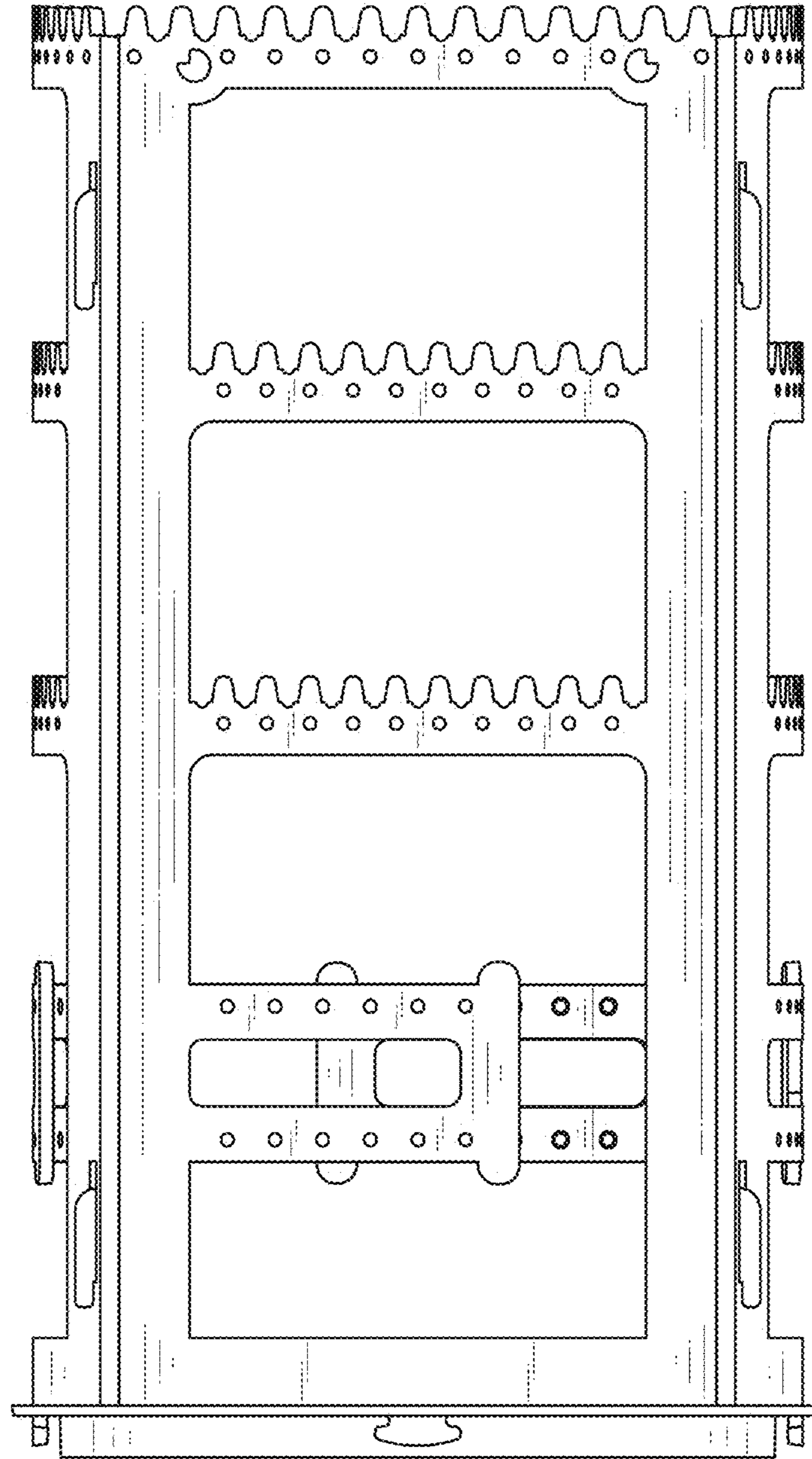

FIG.5

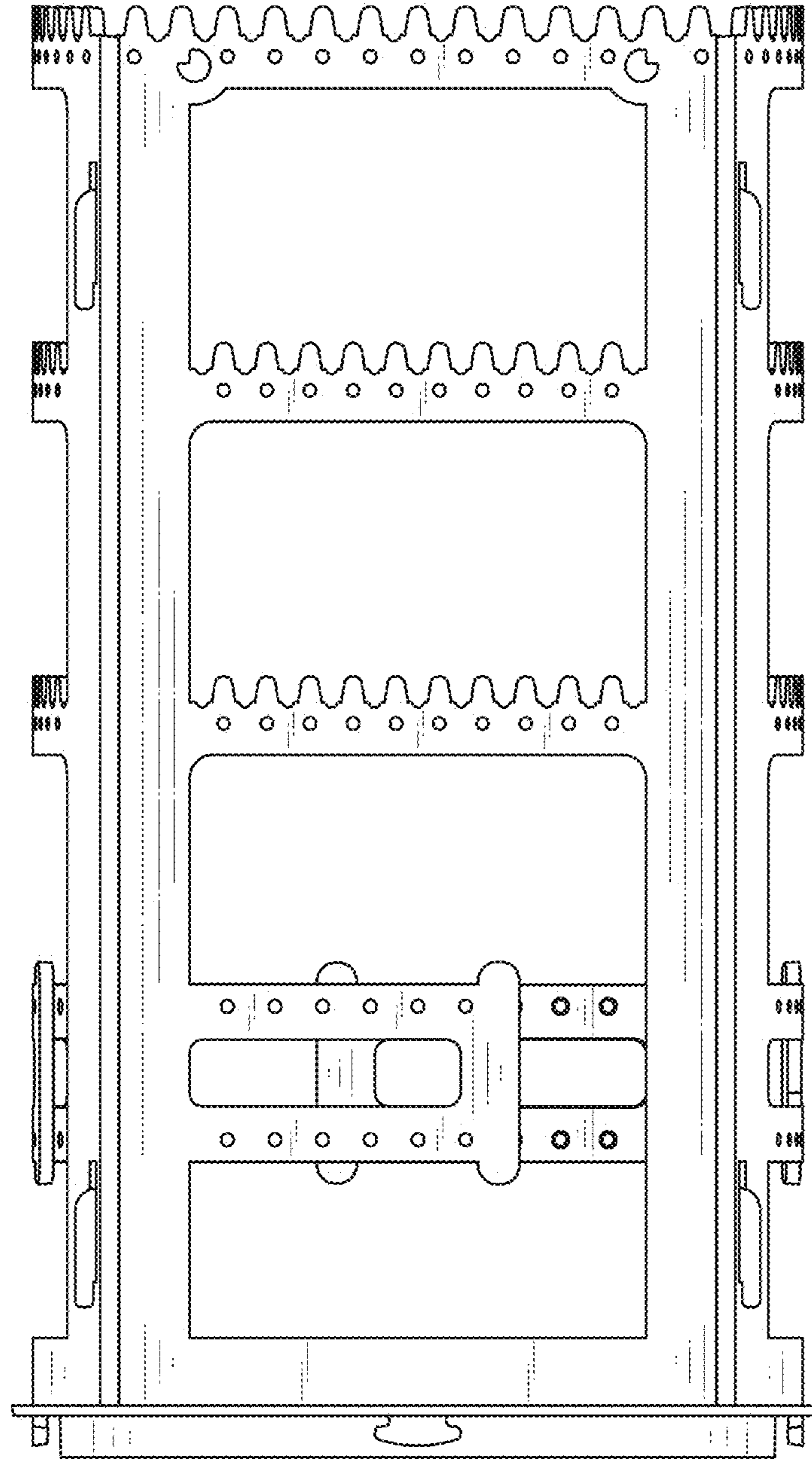

FIG.6

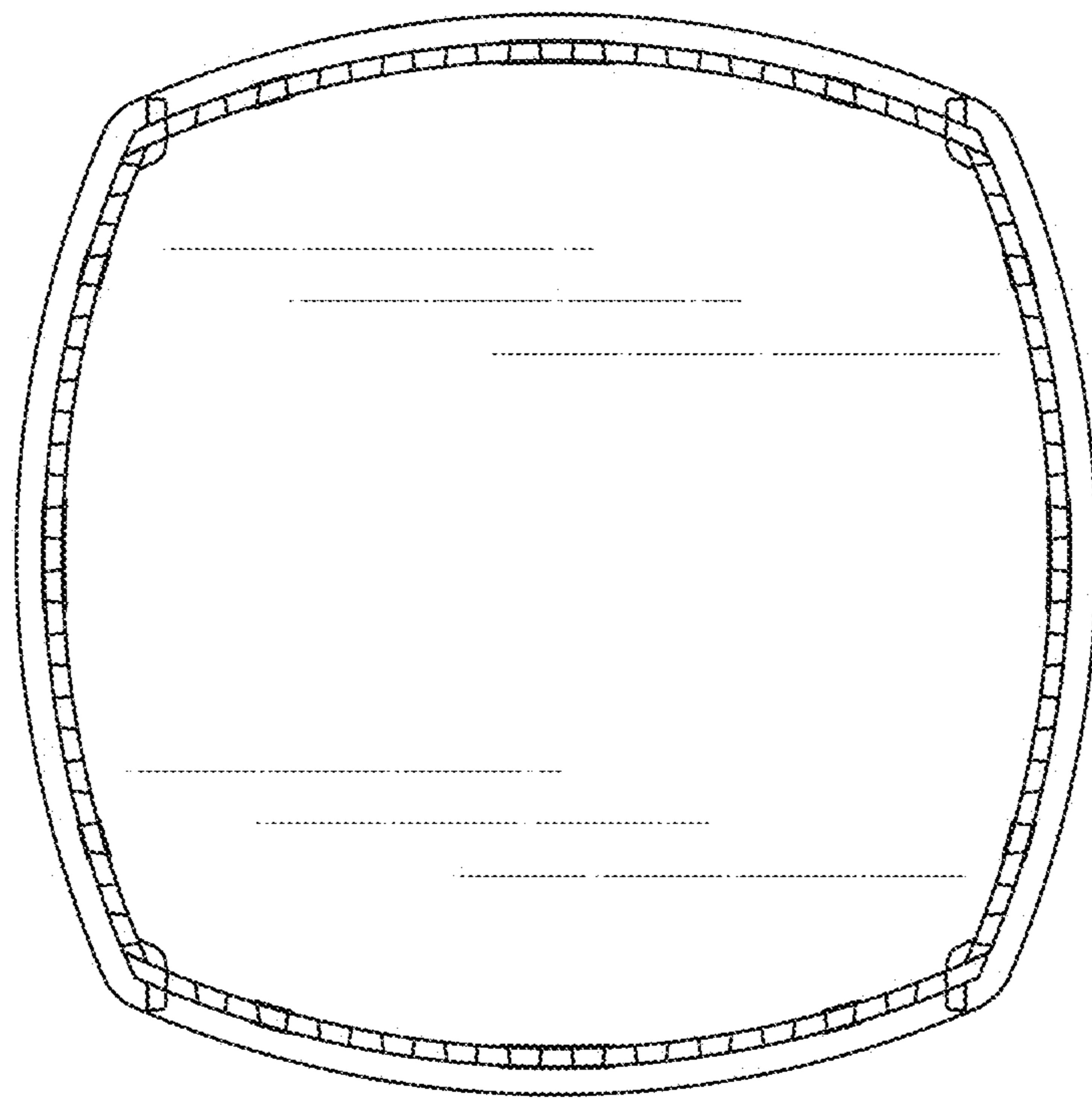

FIG.7

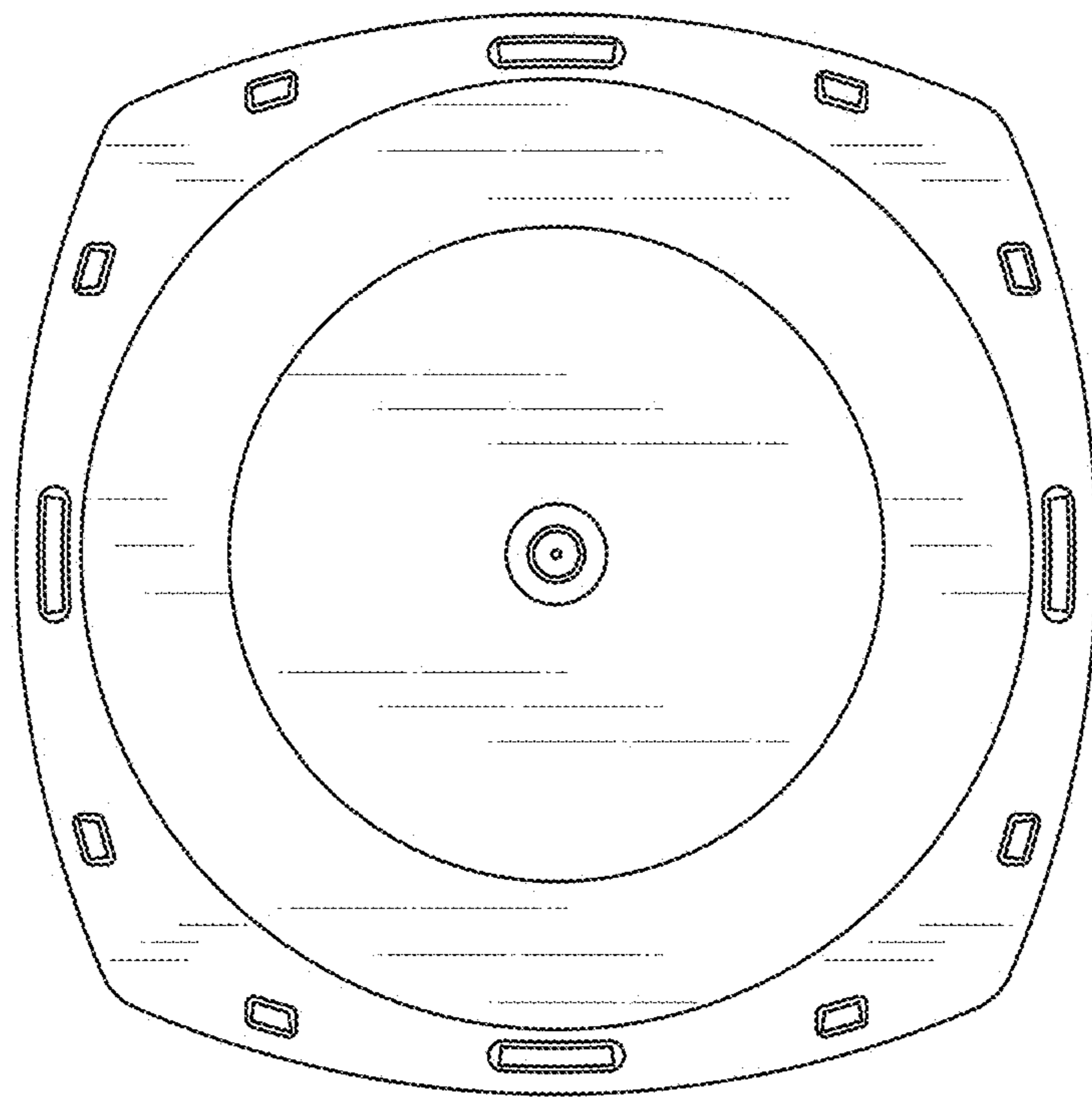

FIG.8