



US00D965286S

(12) **United States Design Patent** (10) **Patent No.:** **US D965,286 S**
Lugo (45) **Date of Patent:** **** Oct. 4, 2022**

(54) **TRAY FOR A CLIPPER CASE** 7,909,162 B1 * 3/2011 Barrett A45D 44/00
 132/286
 (71) Applicant: **Blueprint Ideation, Inc.**, Huntington Park, CA (US) D661,083 S * 6/2012 Frierson D3/205
 D670,909 S 11/2012 Price
 D823,595 S * 7/2018 Yoo D3/205
 D891,085 S * 7/2020 Martin A45D 44/04
 D3/315
 (72) Inventor: **Richard Lugo**, Huntington Park, CA (US) D917,085 S 4/2021 Dong
 2007/0095720 A1 * 5/2007 Barnett, Jr. B65D 25/06
 206/581
 (73) Assignee: **BLUEPRINT IDEATION, INC.**, Huntington Park, CA (US) 2008/0289983 A1 11/2008 Barnett, Jr.
 2010/0089792 A1 * 4/2010 Bryant, Jr. A45D 44/02
 206/581
 (**) Term: **15 Years** 2017/0196342 A1 * 7/2017 Martin A45D 44/04
 2022/0039533 A1 * 2/2022 Siler A45D 27/46

(21) Appl. No.: **29/831,094**
 (22) Filed: **Mar. 17, 2022**
 (51) **LOC (13) Cl.** **03-02**
 (52) **U.S. Cl.**
 USPC **D3/205**
 (58) **Field of Classification Search**
 USPC D3/205
 CPC A45D 44/00; A45D 44/02; A45D 27/22
 See application file for complete search history.

* cited by examiner
Primary Examiner — Charles D Hanson
 (74) *Attorney, Agent, or Firm* — Thompson Coburn LLP

(57) **CLAIM**
 I claim the ornamental design for a tray for a clipper case, as shown and described.

(56) **References Cited**
 U.S. PATENT DOCUMENTS
 D402,855 S 12/1998 Zapata
 D435,185 S * 12/2000 Winchester D6/567
 D439,085 S 3/2001 Quinn
 D443,762 S 6/2001 Park
 D455,032 S 4/2002 Quinn
 D545,500 S * 6/2007 McCambridge D28/74
 7,513,361 B1 * 4/2009 Mills, Jr. A45D 44/00
 206/234
 D621,614 S 8/2010 Zuniga et al.

DESCRIPTION
 FIG. 1 is a top perspective view showing my new design;
 FIG. 2 is a front view thereof;
 FIG. 3 is a left side view thereof;
 FIG. 4 is a right side perspective view thereof;
 FIG. 5 is a top view thereof; and,
 FIG. 6 is another perspective view thereof.
 The broken lines represent environment that forms no part of the claim.

1 Claim, 6 Drawing Sheets

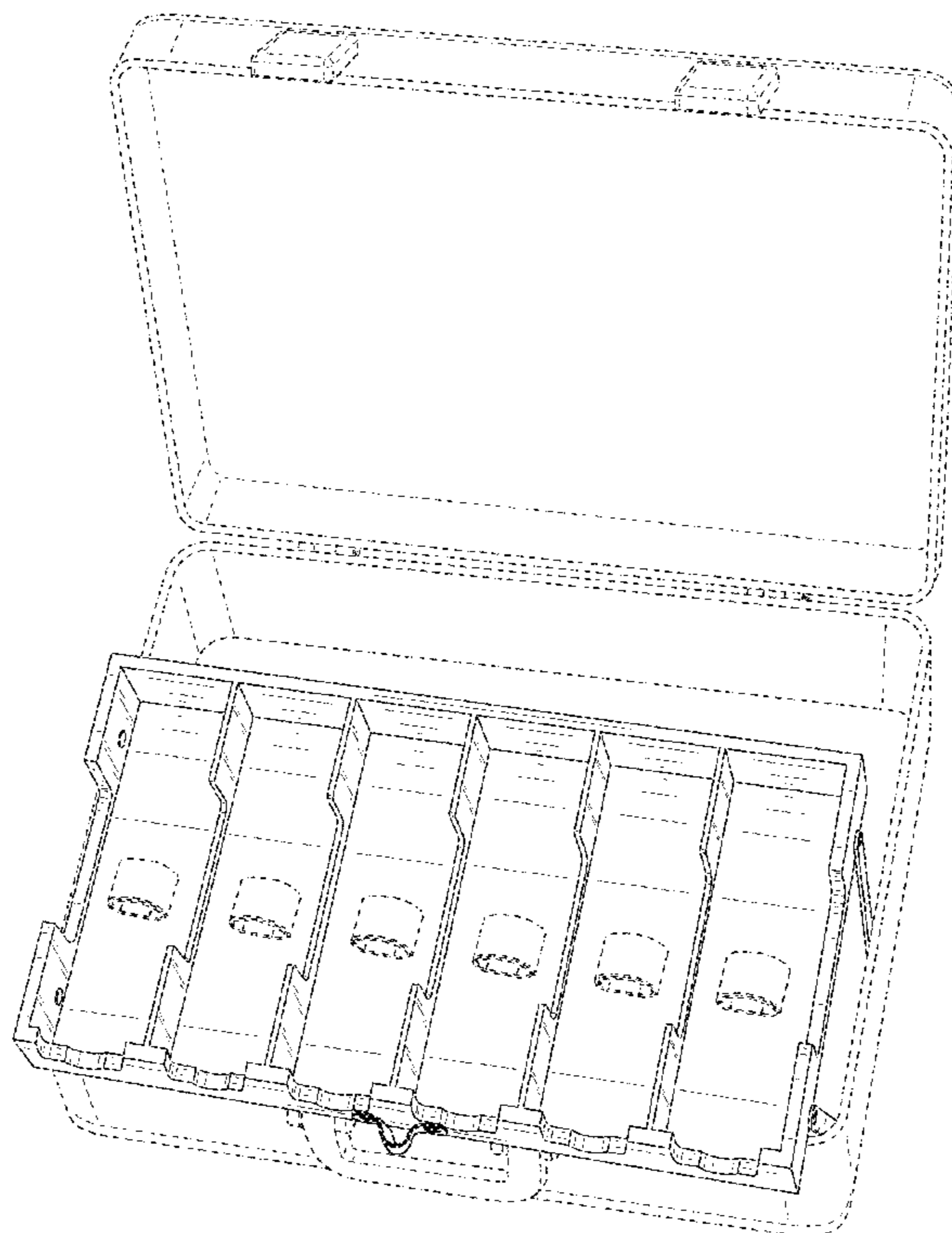

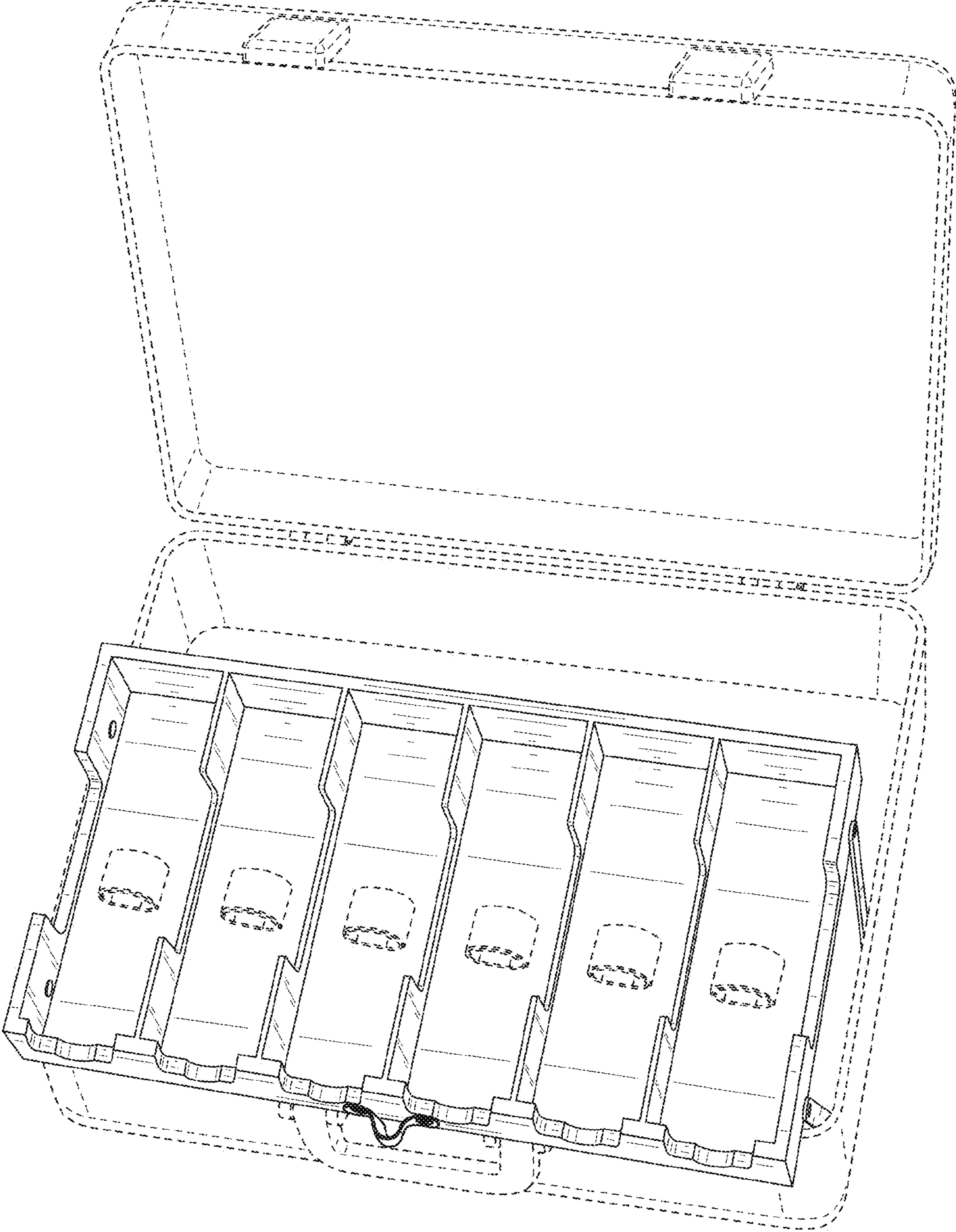

FIG. 1

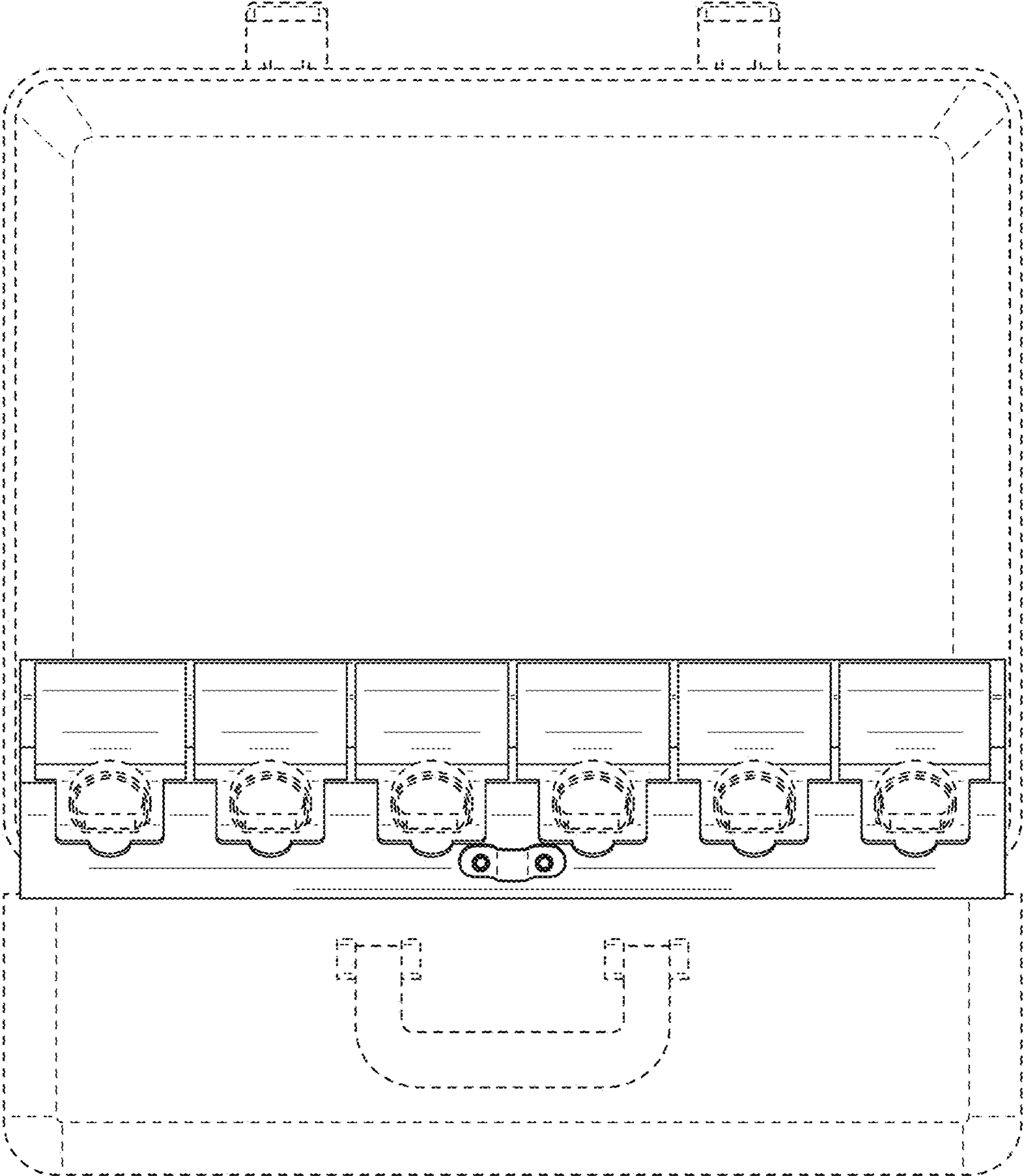

FIG. 2

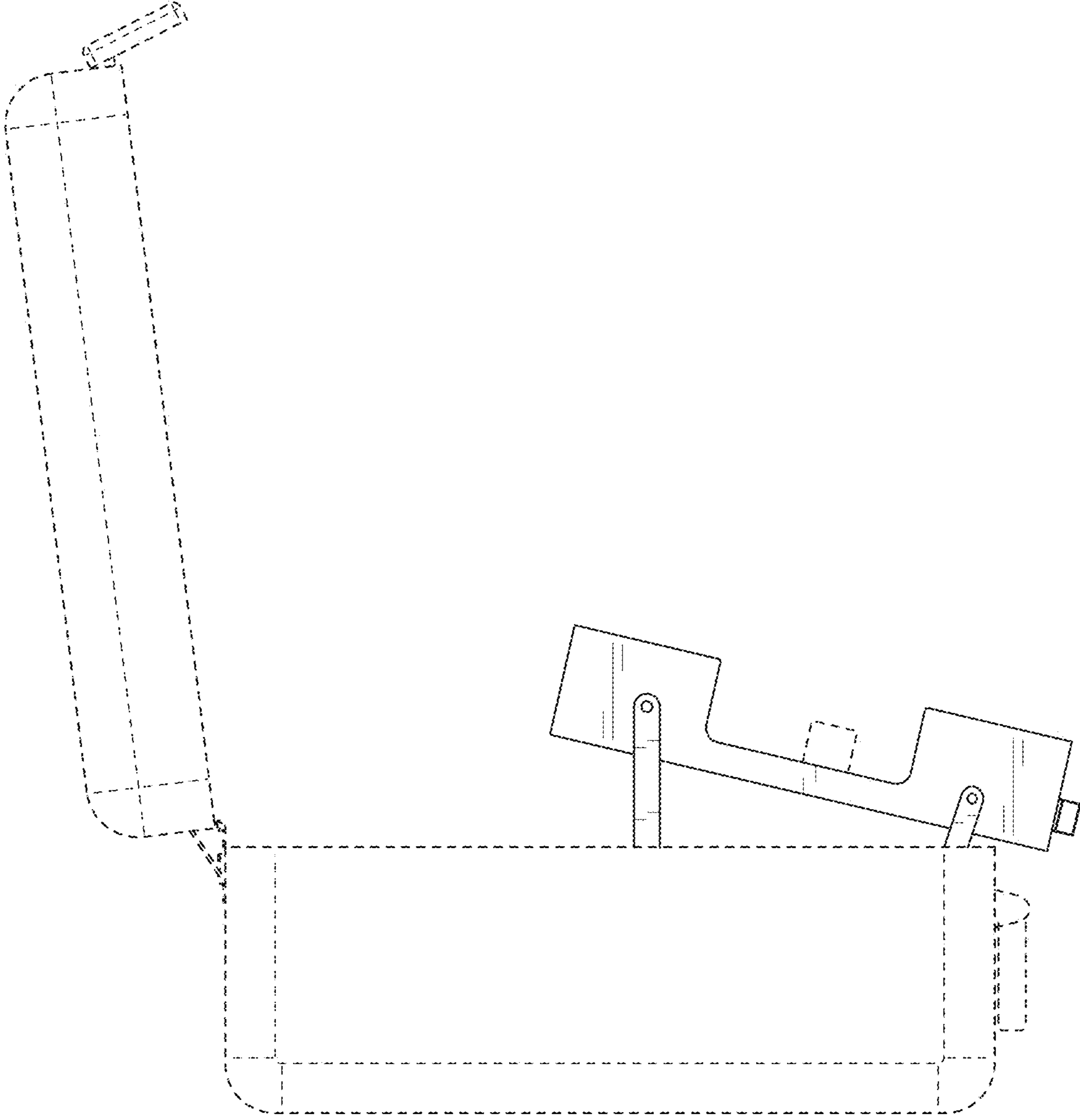

FIG. 3

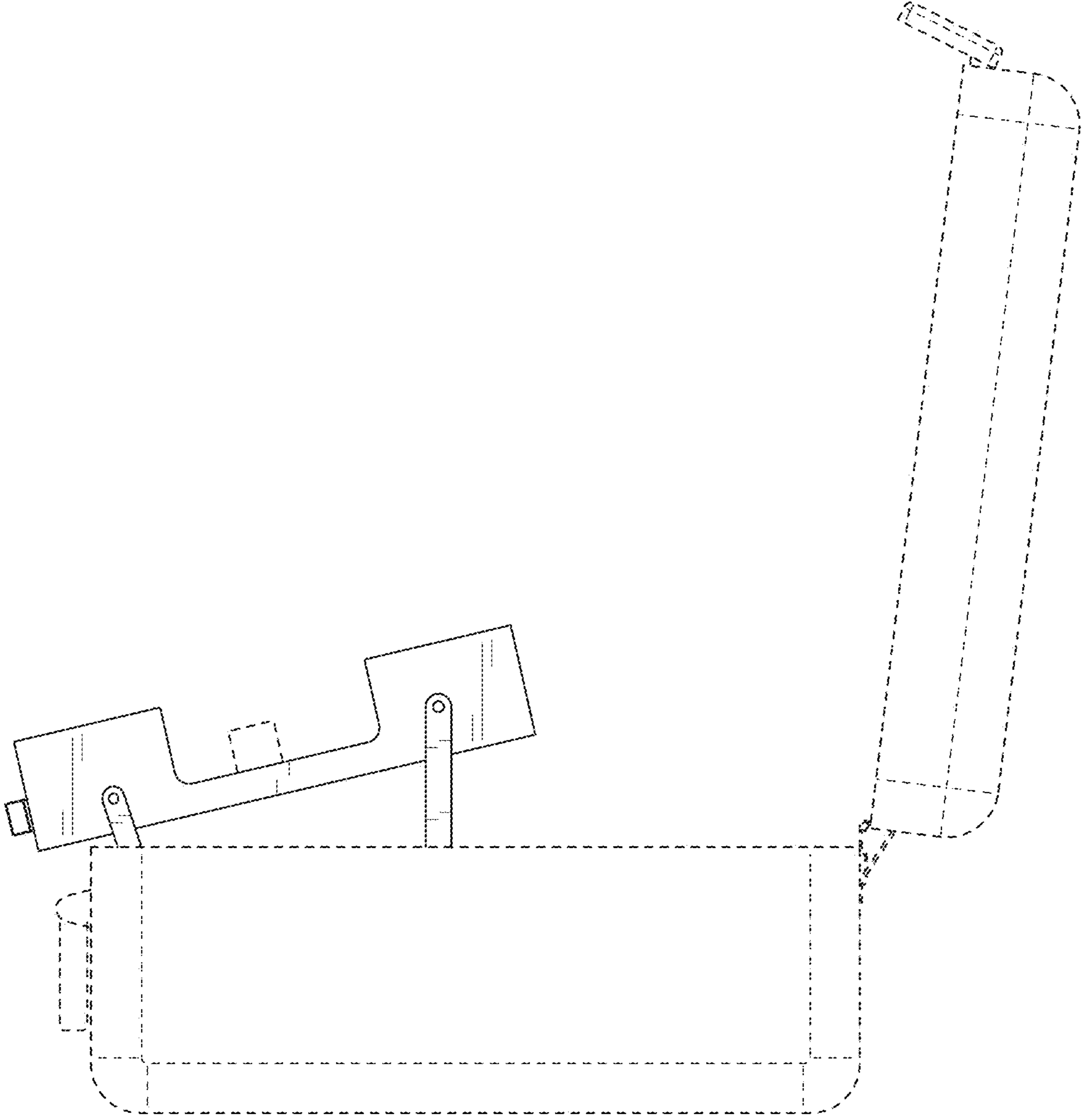

FIG. 4

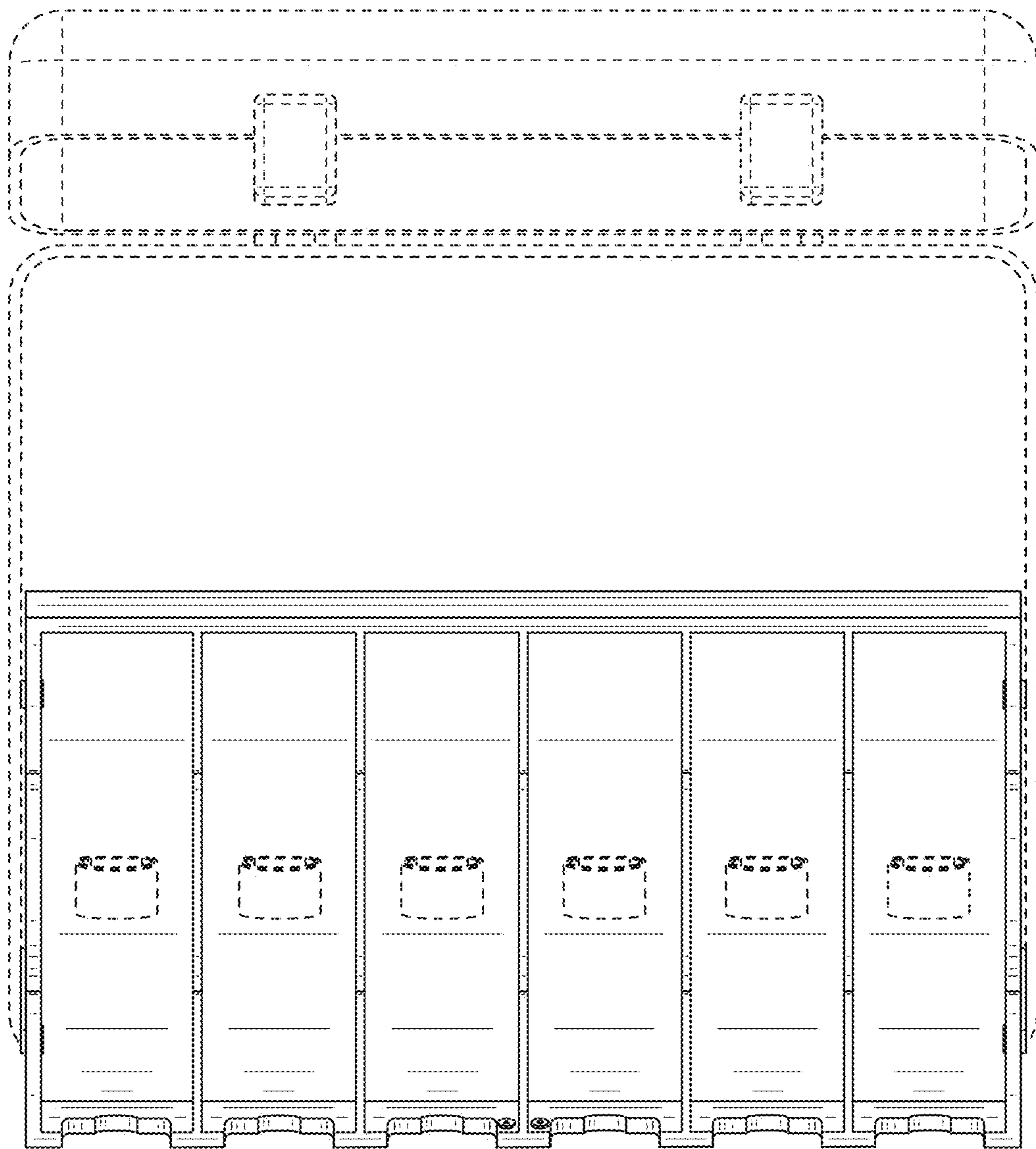

FIG. 5

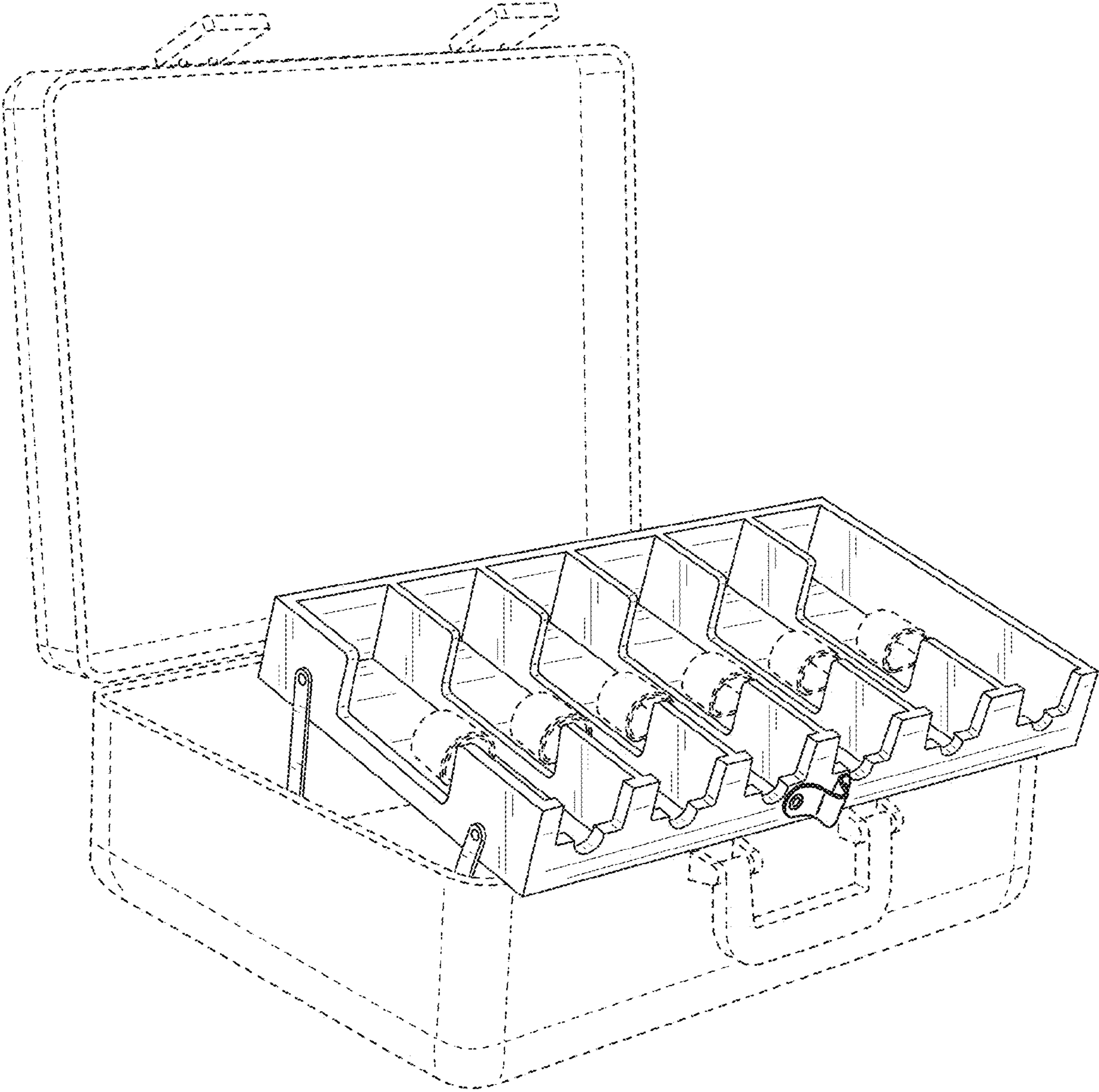

FIG. 6