

US00D965275S

(12) **United States Design Patent** (10) **Patent No.:** **US D965,275 S**
Matthews (45) **Date of Patent:** **** Oct. 4, 2022**

(54) **SHOE**
(71) Applicant: **NIKE, Inc.**, Beaverton, OR (US)
(72) Inventor: **Darryl Matthews**, Portland, OR (US)
(73) Assignee: **NIKE, Inc.**, Beaverton, OR (US)
(**) Term: **15 Years**

D321,972 S 12/1991 Konarowski
D328,517 S 8/1992 Hallenbeck
D340,125 S 10/1993 Johnson et al.
D349,807 S 8/1994 Hatfield et al.
D379,031 S 5/1997 Hatfield
D385,102 S 10/1997 Avar
5,694,703 A * 12/1997 Diaz A43B 3/163
36/7.7

(Continued)

(21) Appl. No.: **29/720,911**
(22) Filed: **Jan. 16, 2020**
(51) **LOC (13) Cl.** **02-04**
(52) **U.S. Cl.**
USPC **D2/972**
(58) **Field of Classification Search**
USPC D2/896, 902, 905, 906, 907, 908, 910,
D2/911, 912, 943, 944, 945, 946, 947,
D2/969, 972, 973
CPC A43B 13/02; A43B 13/00; A43B 13/023;
A43B 13/026; A43B 13/04; A43B 13/08;
A43B 13/10; A43B 13/12; A43B 13/14;
A43B 13/141
See application file for complete search history.

OTHER PUBLICATIONS

“Nike’s ingenious new zipper helps people with disabilities”; The Verge; retrieved Jan. 15, 2020; published Jul. 20, 2015; URL: <<https://www.theverge.com/2015/7/20/9002197/nike-flyease-zipper-disabilities>>.

(Continued)

Primary Examiner — Garth Rademaker
Assistant Examiner — Laura H Yu
(74) *Attorney, Agent, or Firm* — Banner & Witcoff, Ltd.

(57) **CLAIM**

The ornamental design for a shoe, as shown and described.

DESCRIPTION

FIG. 1 is a front perspective view of a shoe showing my new design;
FIG. 2 is a side view thereof;
FIG. 3 is a rear perspective view thereof;
FIG. 4 is an opposite side rear perspective view thereof;
FIG. 5 is an opposite side view thereof;
FIG. 6 is an opposite side front perspective view thereof;
FIG. 7 is a front view thereof; and,
FIG. 8 is a top view thereof.
The broken line immediately adjacent to the shaded area defines the bound of the claimed design and form no part thereof. The broken lines depicting the remainder of the shoe form no part of the claimed design.

(56) **References Cited**
U.S. PATENT DOCUMENTS
D103,587 S * 3/1937 Perugia D2/911
D108,491 S 2/1938 Ford
D150,694 S * 8/1948 Hardman D2/911
D169,889 S * 6/1953 Bollenbach D2/901
D173,138 S * 10/1954 Bingham D2/911
D272,771 S 2/1984 Muller Feigelstock
D272,964 S 3/1984 Muller Feigelstock
D281,926 S 12/1985 Hill
D283,463 S 4/1986 Chassaing
D284,039 S 6/1986 Yoshitake
D297,069 S 8/1988 Le
D297,382 S 8/1988 Swett
D300,282 S 3/1989 Brown et al.
D309,823 S 8/1990 Kilgore et al.

1 Claim, 8 Drawing Sheets

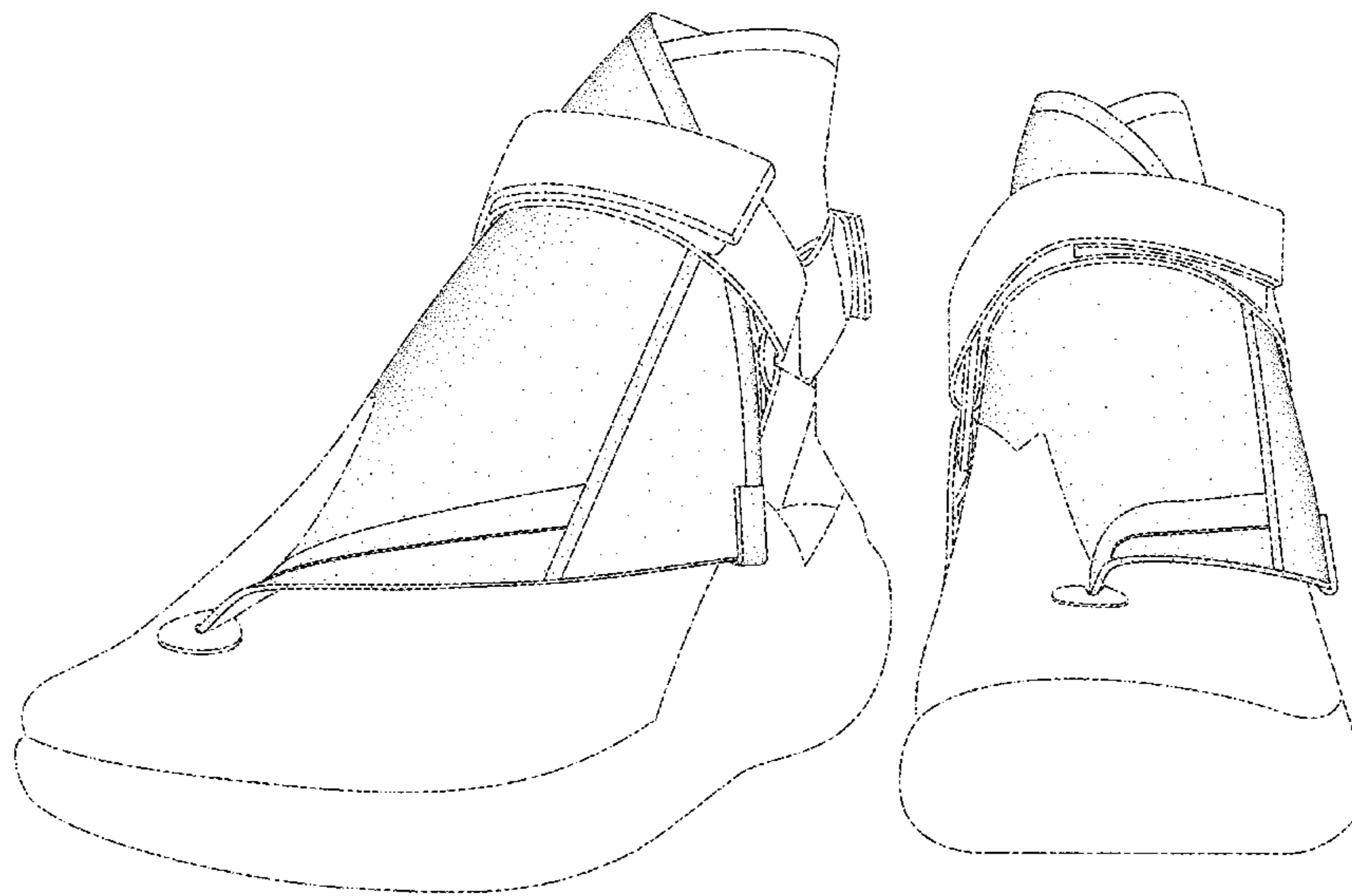

(56)

References Cited

U.S. PATENT DOCUMENTS

D398,769	S	*	9/1998	Avar	D2/972
D420,208	S	*	2/2000	Birkenstock	D2/951
D429,064	S	*	8/2000	Lozano	D2/972
D459,870	S	*	7/2002	St. Louis	D2/973
D472,041	S	*	3/2003	Kuerbis	D2/975
D564,188	S	*	3/2008	Woodbury	D2/913
D575,947	S	*	9/2008	Minami	D2/969
D720,881	S		1/2015	Liu		
D750,881	S		3/2016	Hardman		
D789,047	S	*	6/2017	Bruder	D2/902
D790,192	S	*	6/2017	Hardman	D2/972
9,826,795	B2	*	11/2017	Foxen	A43B 7/20
D817,621	S	*	5/2018	Madore	D2/969
D858,075	S		9/2019	Schultze		
D943,249	S	*	2/2022	Gillespie	D2/911

OTHER PUBLICATIONS

“The Complete Nike Mag Price Guide”; sole collector; retrieved Jan. 15, 2020; published Nov. 22, 2017; URL: <<https://solecollector.com/news/2017/11/how-much-are-nike-mag-back-to-the-future-sneakers/>>.

* cited by examiner

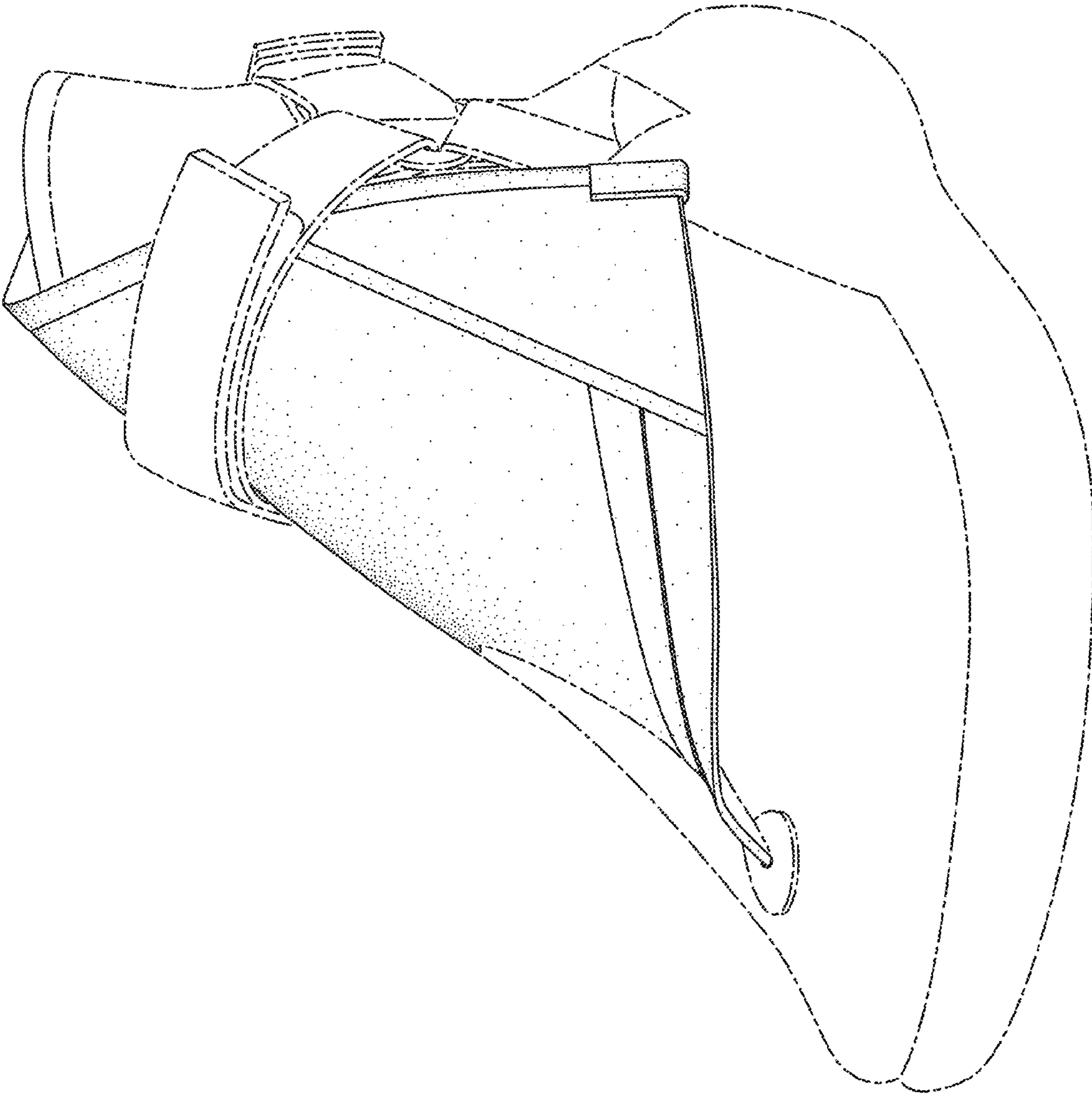

FIG. 1

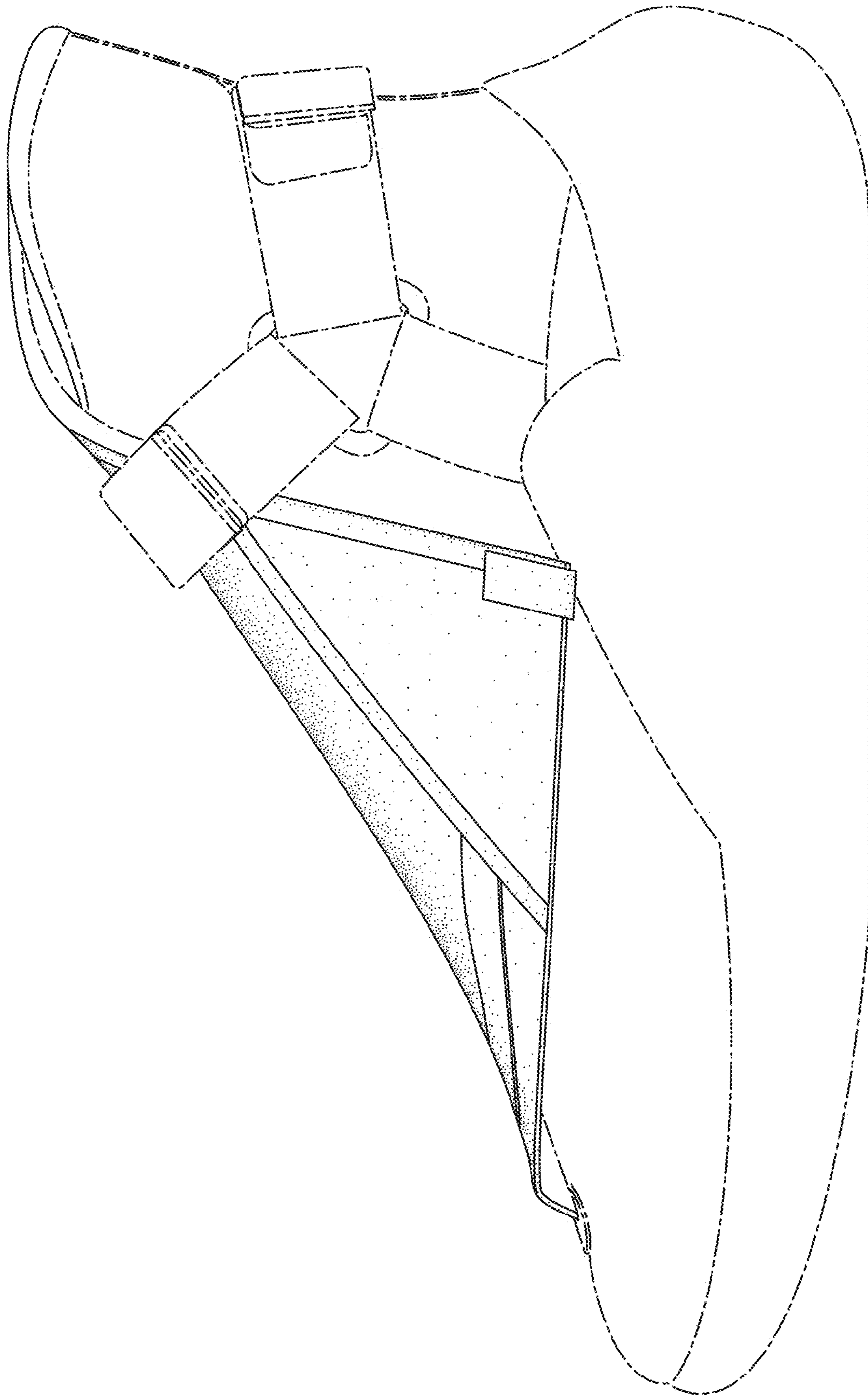

FIG. 2

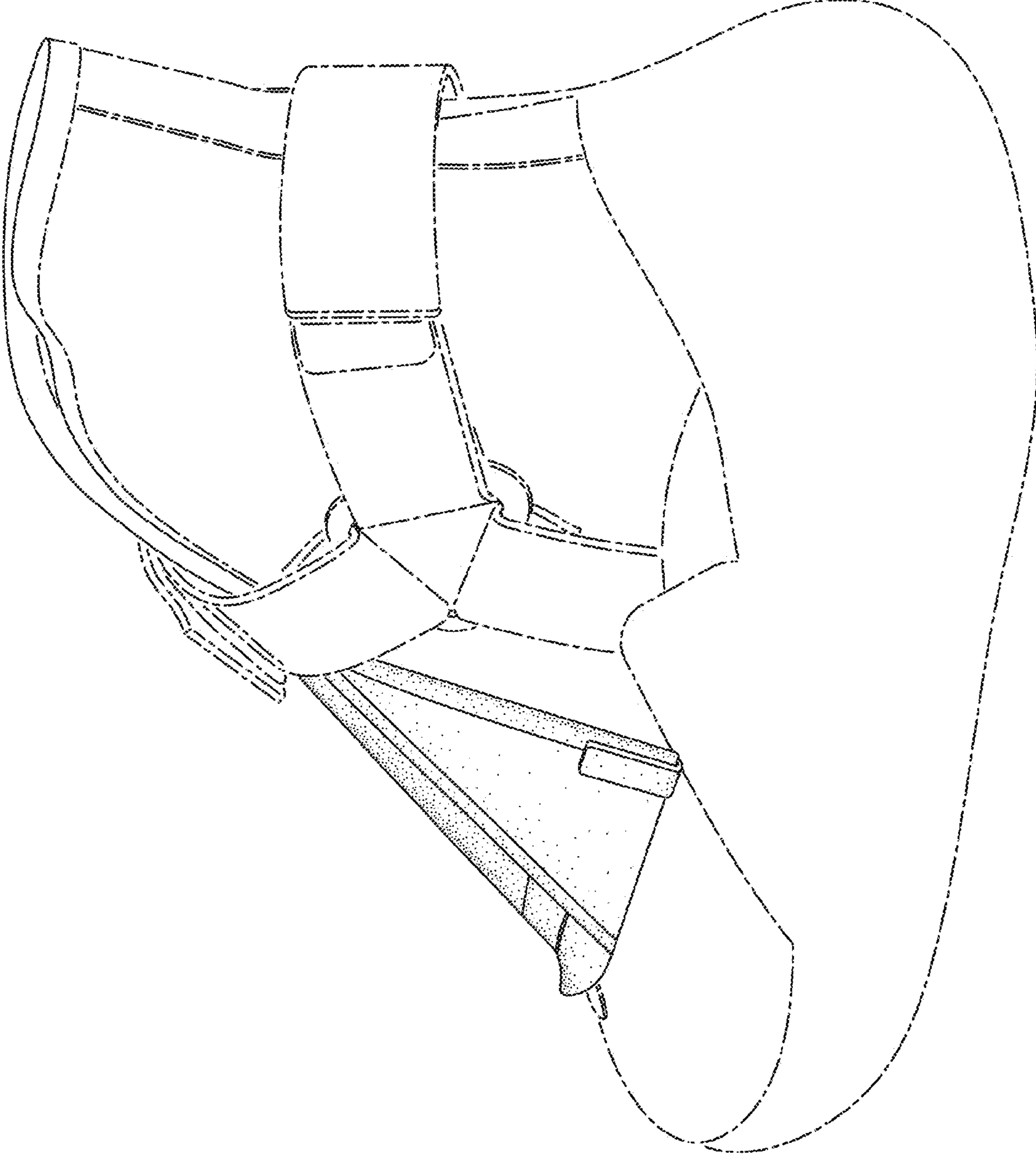

FIG. 3

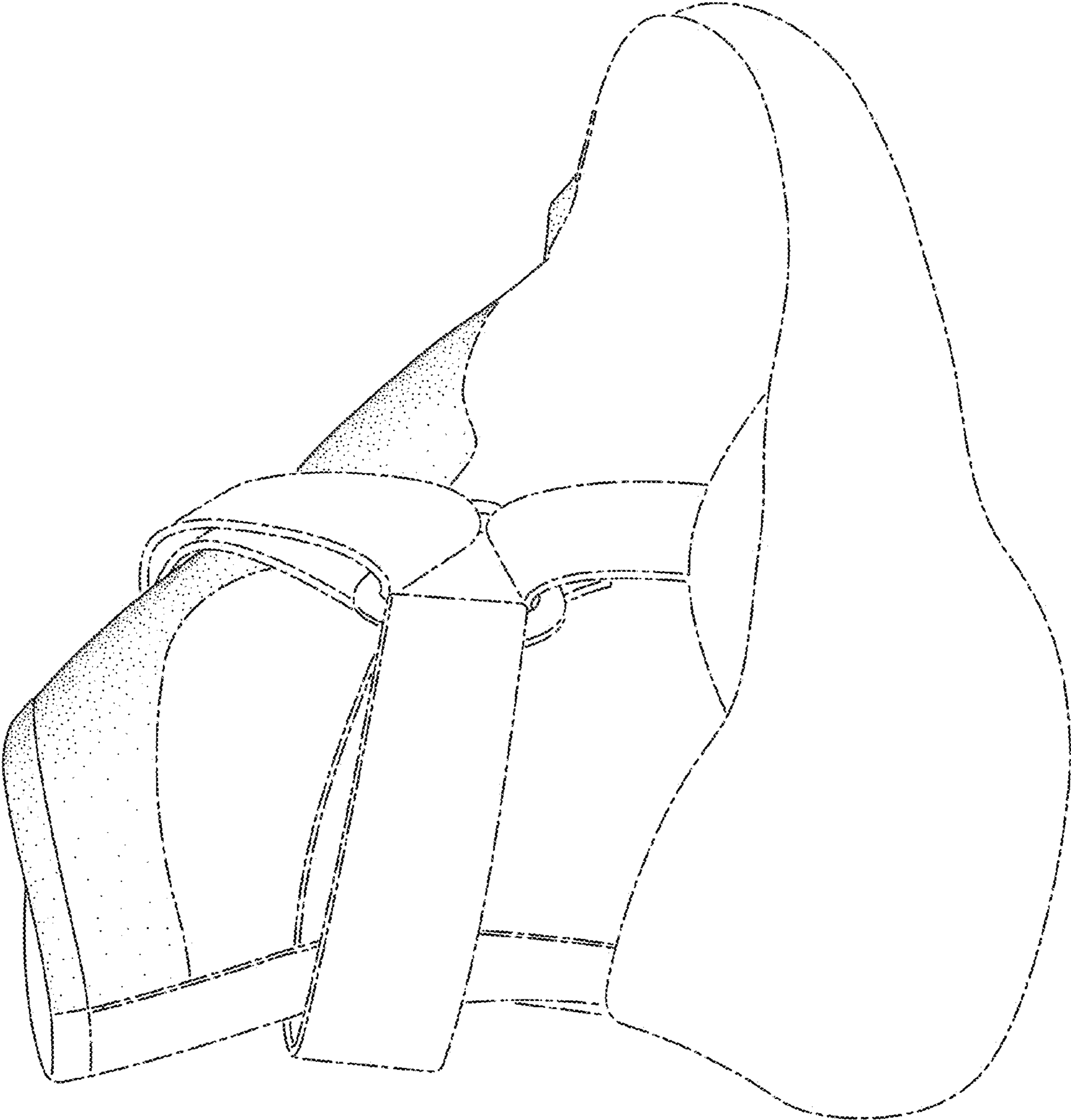

FIG. 4

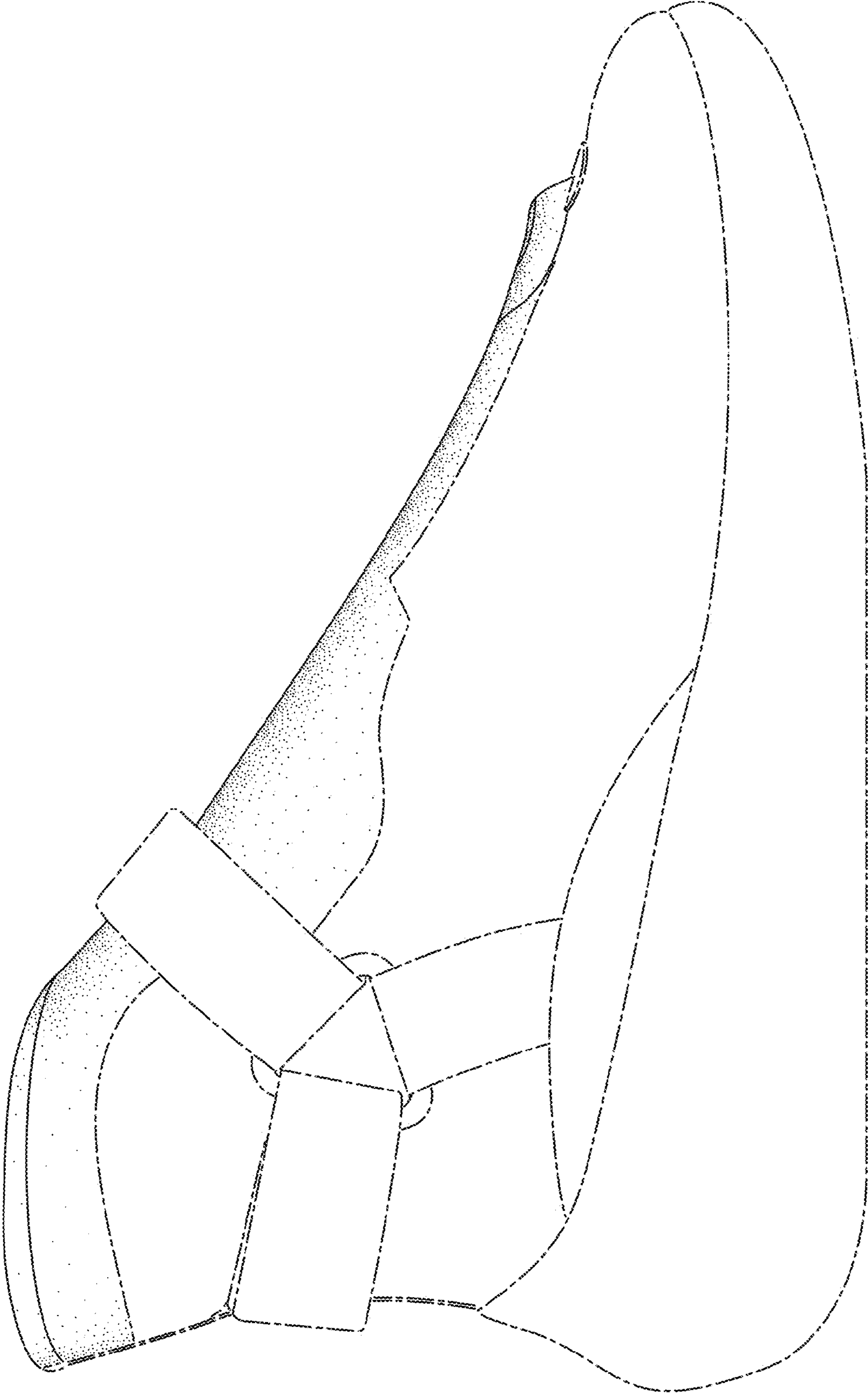

FIG. 5

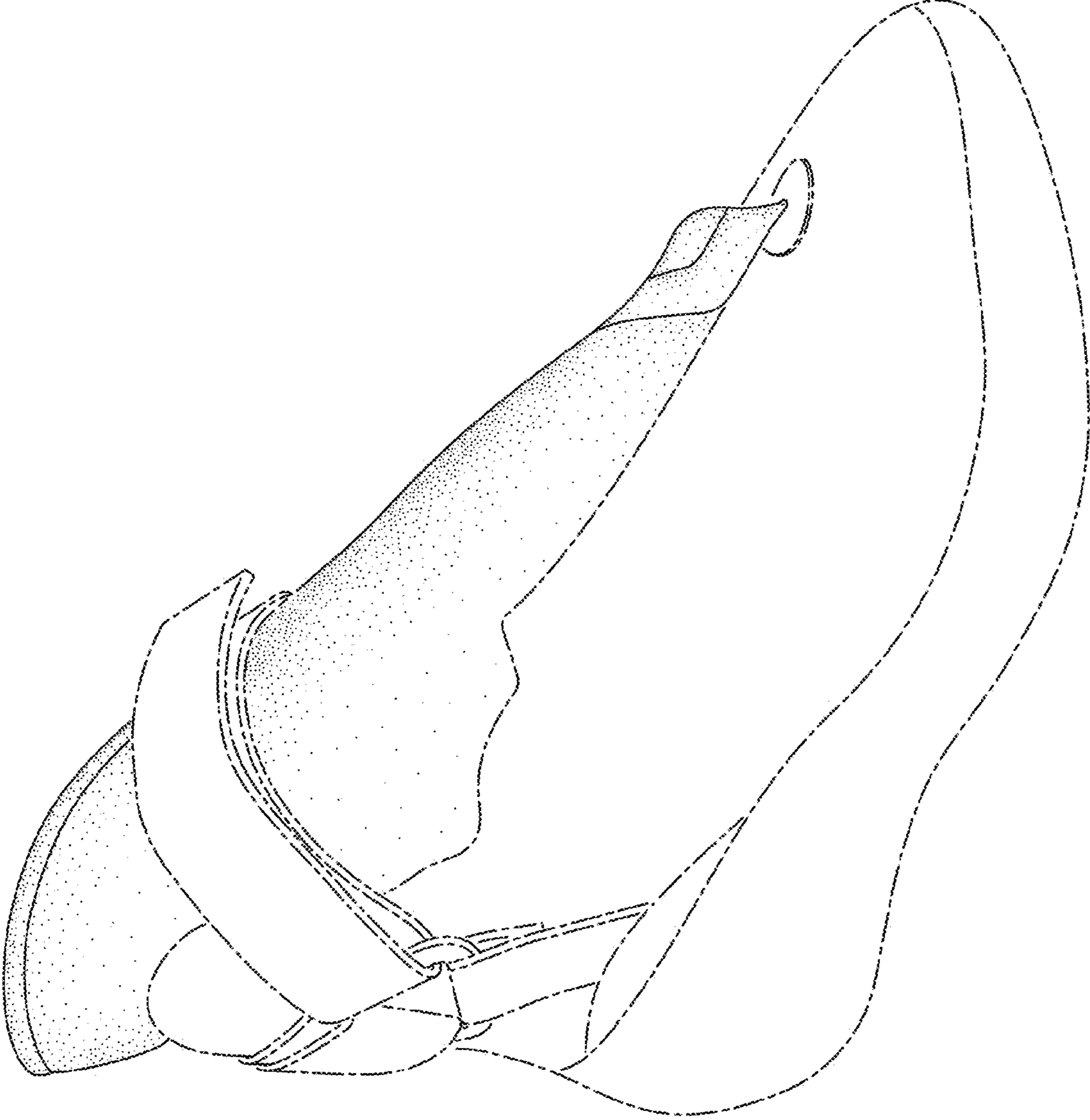

FIG. 6

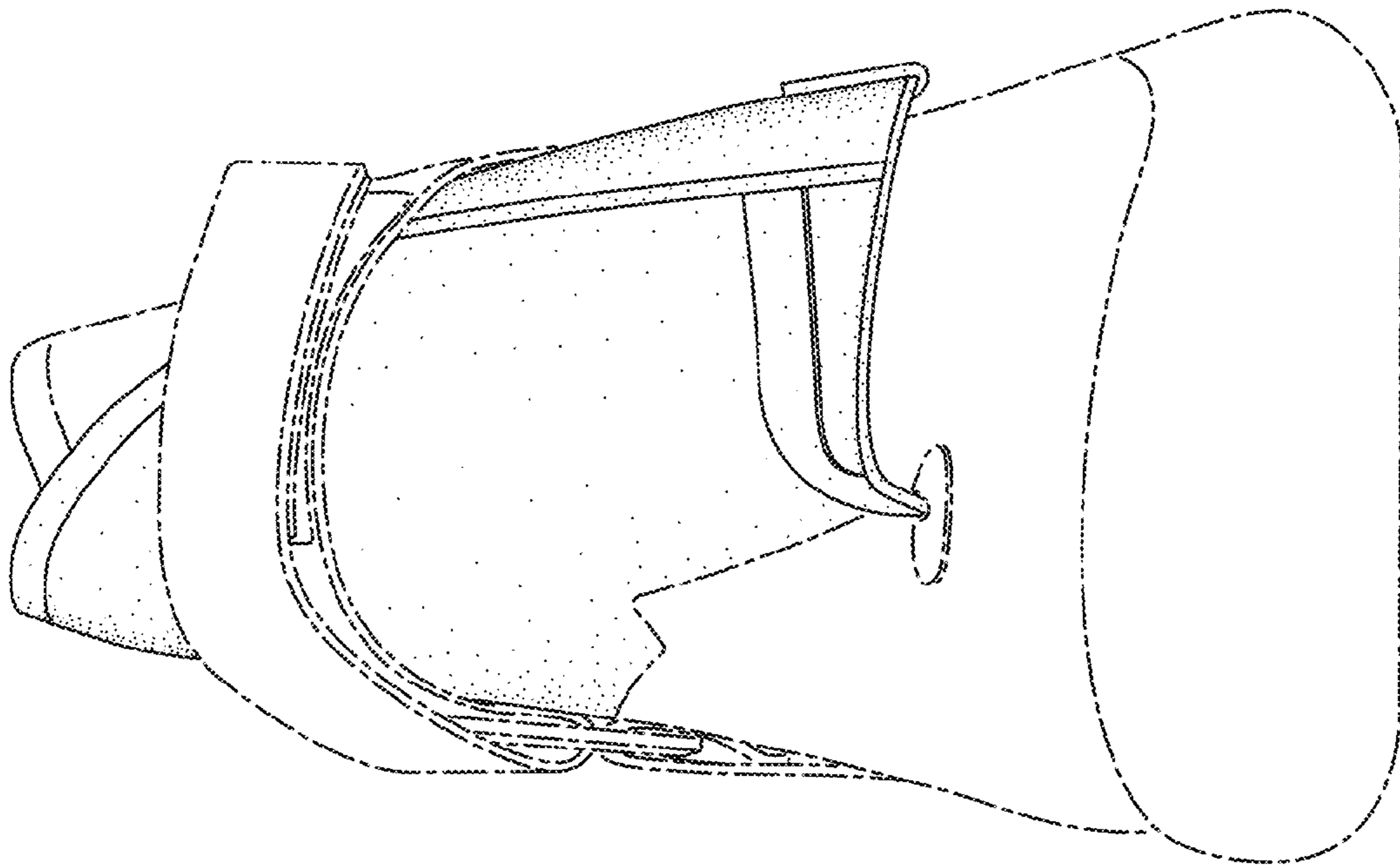

FIG. 7

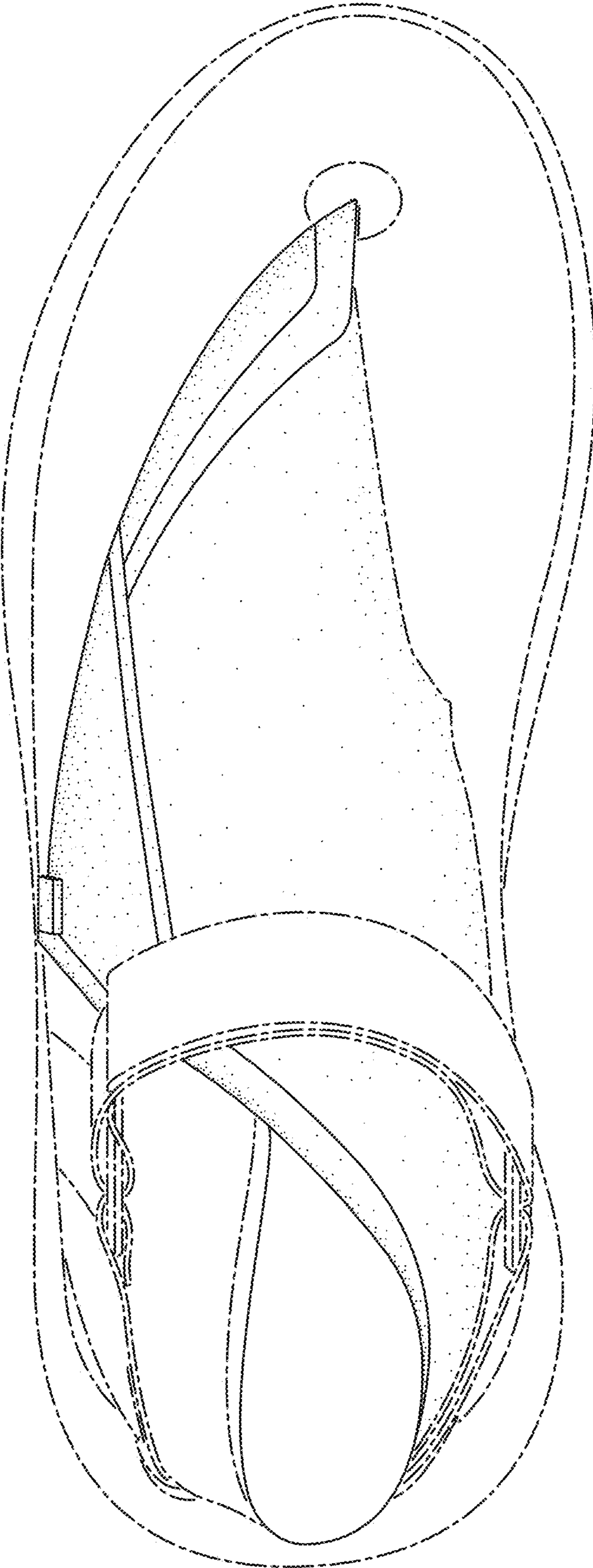

FIG. 8