



US00D965228S

(12) **United States Design Patent** (10) **Patent No.:** **US D965,228 S**
Wan (45) **Date of Patent:** **** Sep. 27, 2022**

(54) **BICYCLE HELMET**
(71) Applicant: **Shenzhen You Yun An intelligent Technology Co., Ltd., Shenzhen (CN)**
(72) Inventor: **Ning Wan, Shenzhen (CN)**
(73) Assignee: **SHENZHEN YOU YUN AN INTELLIGENT TECHNOLOGY CO., LTD., Shenzhen (CN)**

D921,989 S * 6/2021 Petzl A42B 3/066
D29/102
D927,076 S * 8/2021 Raja D29/102
D930,910 S * 9/2021 Wu D29/102

FOREIGN PATENT DOCUMENTS

CN 306264351 * 1/2021
JP D1670303 * 10/2020

(Continued)

OTHER PUBLICATIONS

Smith Optics Trace MIPS Adult Cycling Helmet, available in Amazon.ca, date first available Feb. 19, 2019 [online], [site visited Jan. 24, 2022], Available from the internet URL: https://www.amazon.ca/dp/B07GLKJQ4M/ref=cm_sw_em_r_mt_dp_PFJ2APKQ02FM8S5EJ8FR?_encoding=UTF8&psc=1 (Year: 2019).*

(Continued)

Primary Examiner — Jennifer L Rempfer
Assistant Examiner — Elizabeth Anne Glassberg
(74) *Attorney, Agent, or Firm* — WPAT, PC

(57) **CLAIM**

The ornamental design for a bicycle helmet, as shown and described.

DESCRIPTION

FIG. 1 is a perspective view of a bicycle helmet, showing the new design;
FIG. 2 is a front view thereof;
FIG. 3 is a rear view thereof;
FIG. 4 is a left-side view thereof;
FIG. 5 is a right-side view thereof;
FIG. 6 is a top view thereof; and,
FIG. 7 is a bottom view thereof.
The broken lines depict portions of the bicycle helmet that form no part of the claimed design.

1 Claim, 7 Drawing Sheets

(**) Term: **15 Years**
(21) Appl. No.: **29/748,958**
(22) Filed: **Sep. 2, 2020**
(51) **LOC (13) Cl.** **02-03**
(52) **U.S. Cl.**
USPC **D29/102**
(58) **Field of Classification Search**
USPC D2/870, 872, 878; D29/100, 102, 103, D29/104, 105, 106, 107, 108, 110, 122
CPC .. A41D 13/11; A42B 3/04; A42B 3/18; A42B 3/20; A42B 3/185; A42B 3/226; A42B 3/0406; A61F 9/06; A61F 9/029; A63B 2071/105; A63B 71/08; A63B 71/10
See application file for complete search history.

(56) **References Cited**

U.S. PATENT DOCUMENTS

D351,684 S * 10/1994 Jeng D29/102
D352,803 S * 11/1994 Sasaki D29/102
D383,249 S * 9/1997 Ho D29/102
D387,501 S * 12/1997 Cheng D29/102
D389,280 S * 1/1998 Ho D29/102
D853,040 S * 7/2019 Melegari A42B 3/066
D29/102
D854,252 S * 7/2019 Yu D29/102
D903,947 S * 12/2020 Pietruck D29/102
D918,479 S * 5/2021 Boglione D29/102

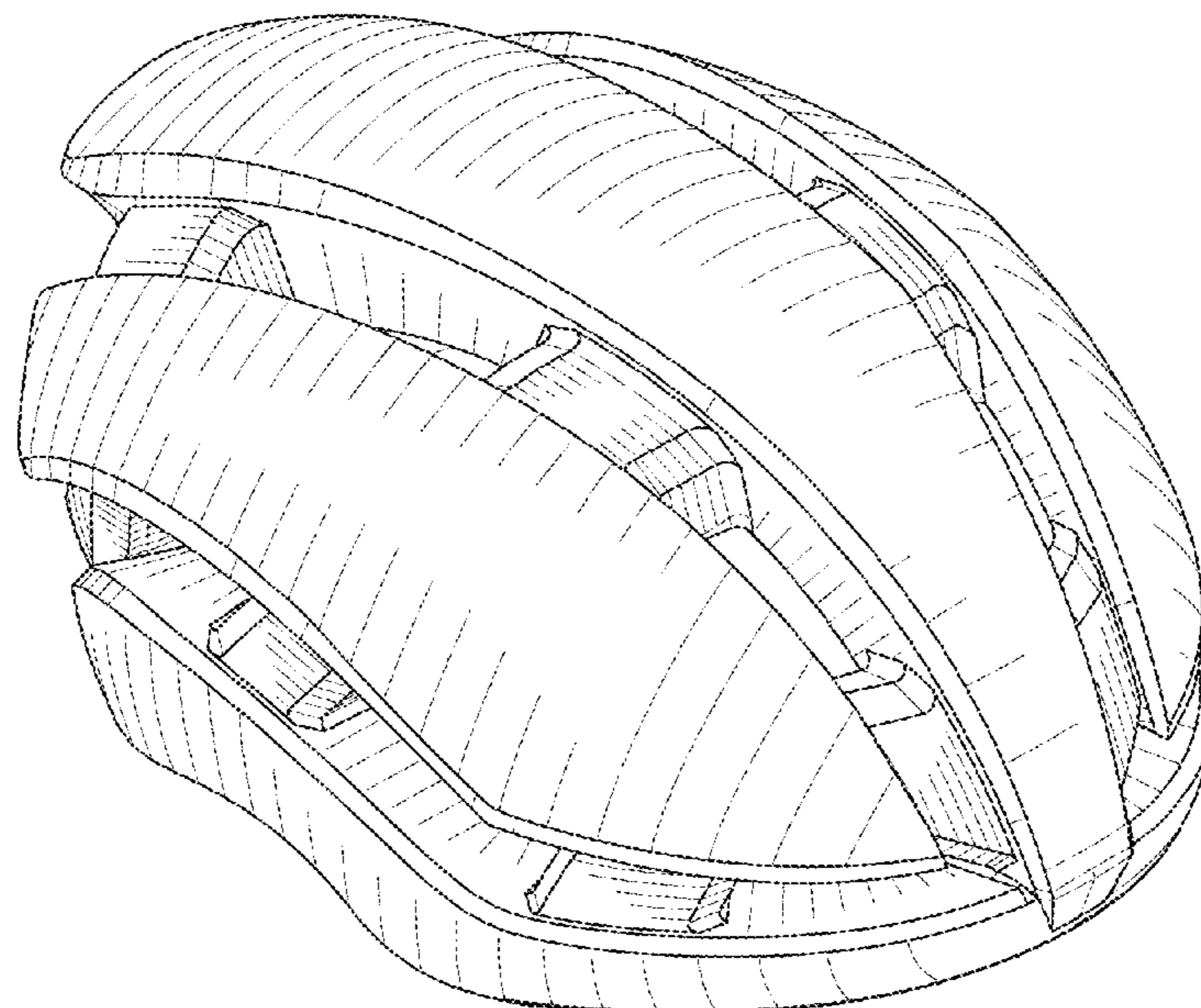

(56)

References Cited

FOREIGN PATENT DOCUMENTS

JP	D1682310	*	3/2021
KR	301090532	*	1/2021

OTHER PUBLICATIONS

ROCKBROS Bike Helmet, available in Amazon.co.uk, date first available Sep. 11, 2019 [online], [site visited Jan. 24, 2022], Available from the internet URL: https://www.amazon.co.uk/dp/B07XRCLSNQ/ref=cm_sw_em_r_mt_dp_7NF9GHA7BKB7405RPD1S?th=1 (Year: 2019).*

Retrospec Lennon Bike Helmet, available in Amazon.com, date first available May 28, 2021 [online], [site visited Jan. 24, 2022], Available from the internet URL: https://www.amazon.com/dp/B08GL2JKMR/ref=cm_sw_em_r_mt_dp_JZWP2Q8K7BS3D249H4Y6 (Year: 2021).*

* cited by examiner

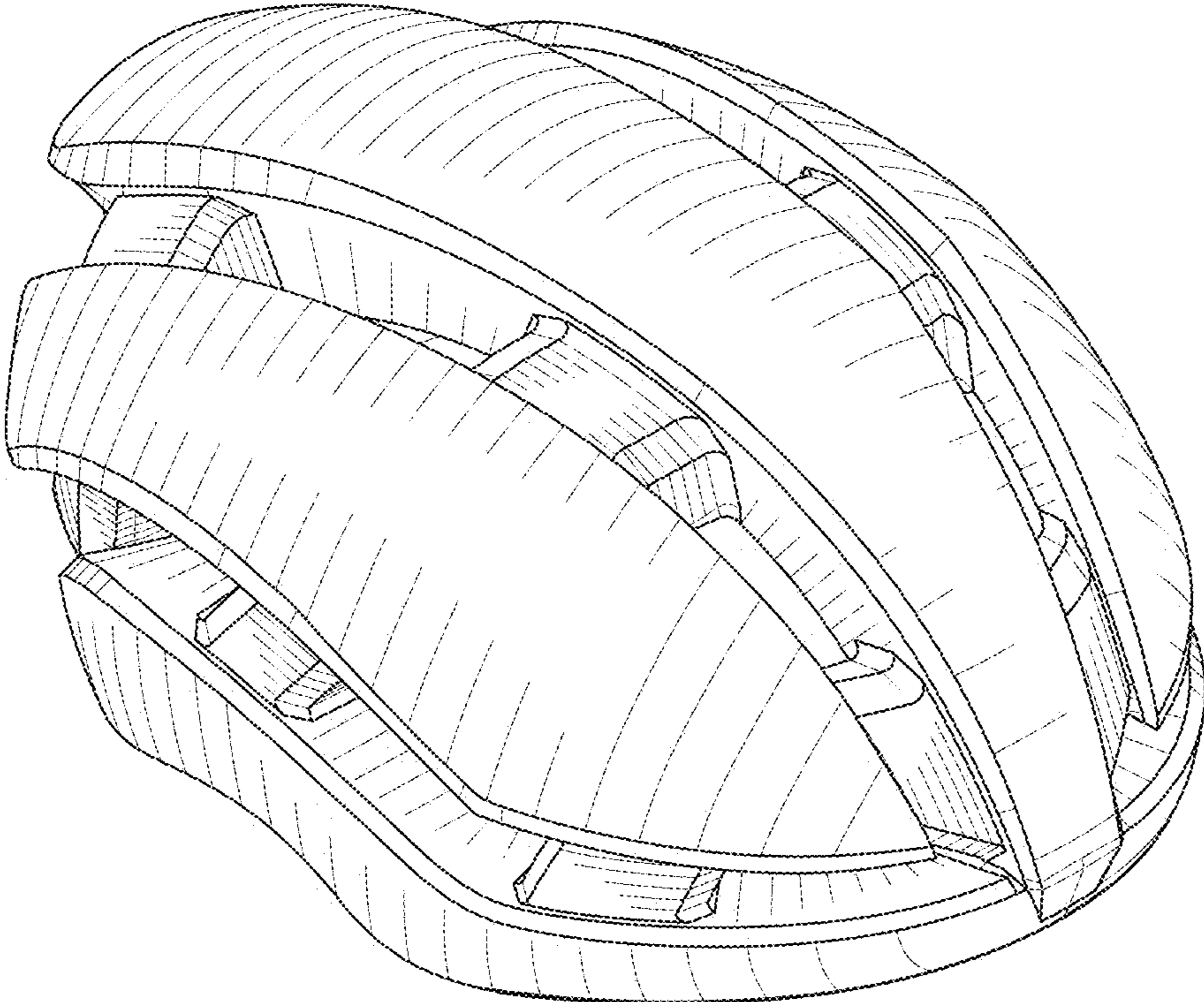

FIG. 1

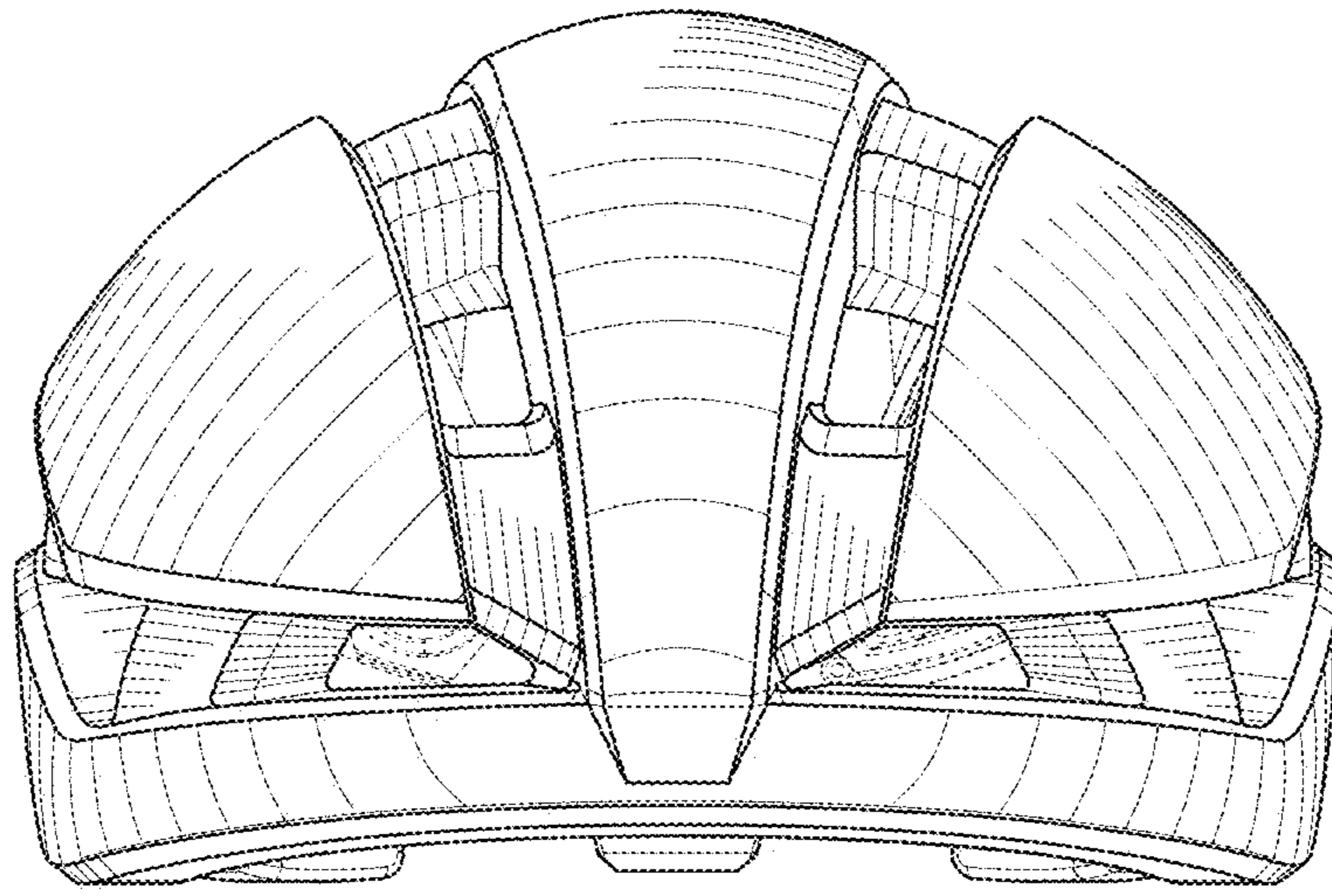

FIG. 2

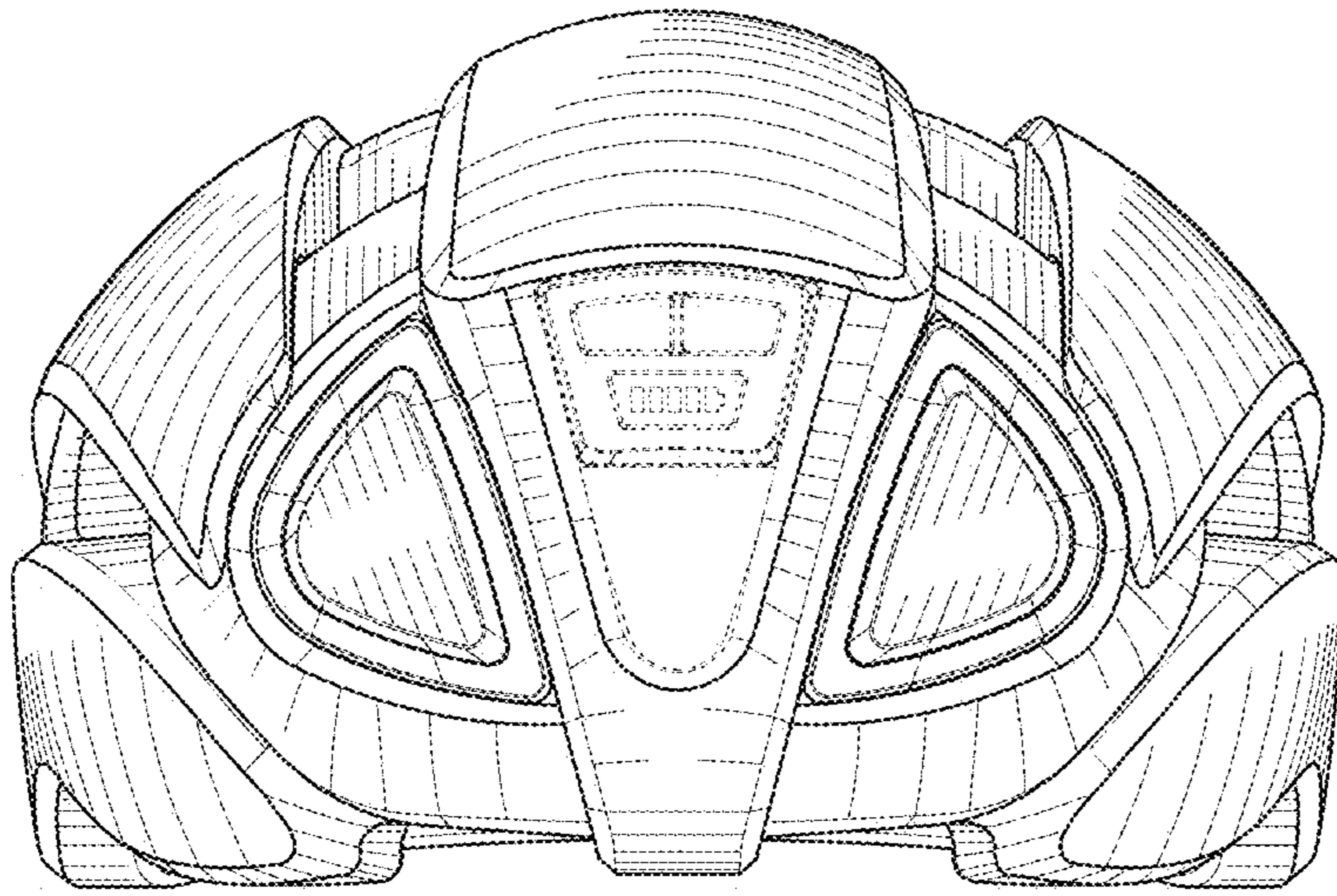

FIG. 3

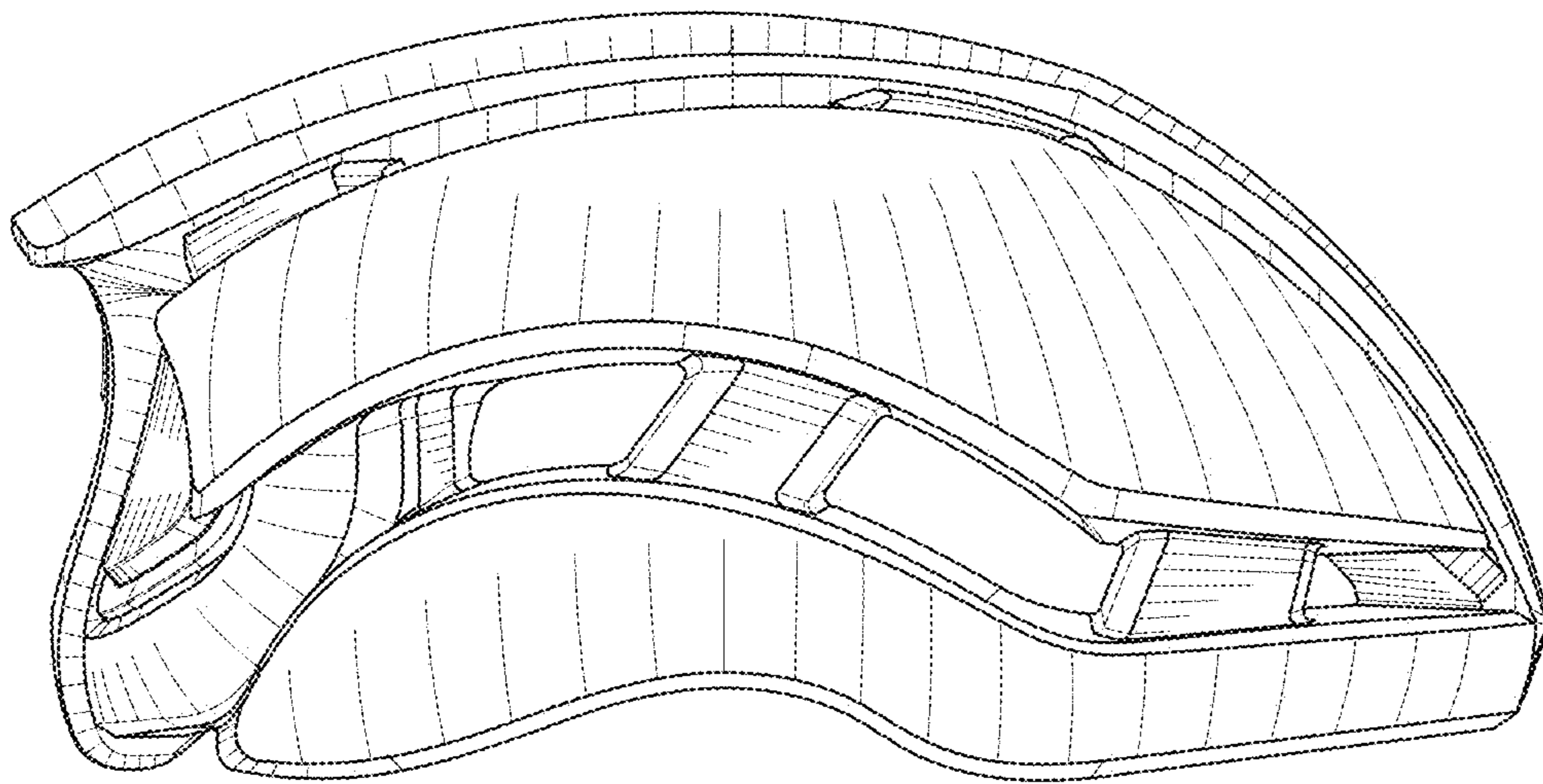

FIG. 4

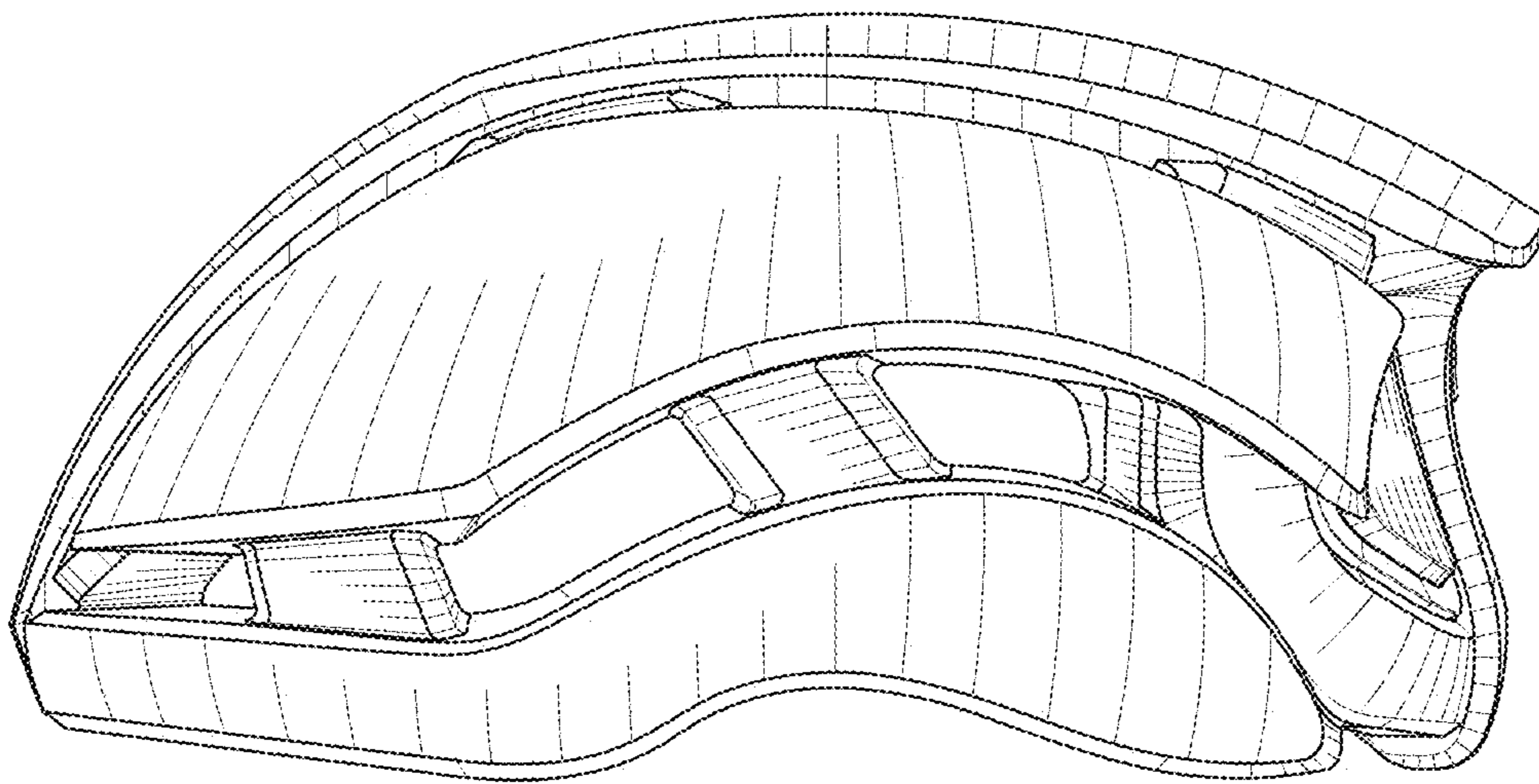

FIG. 5

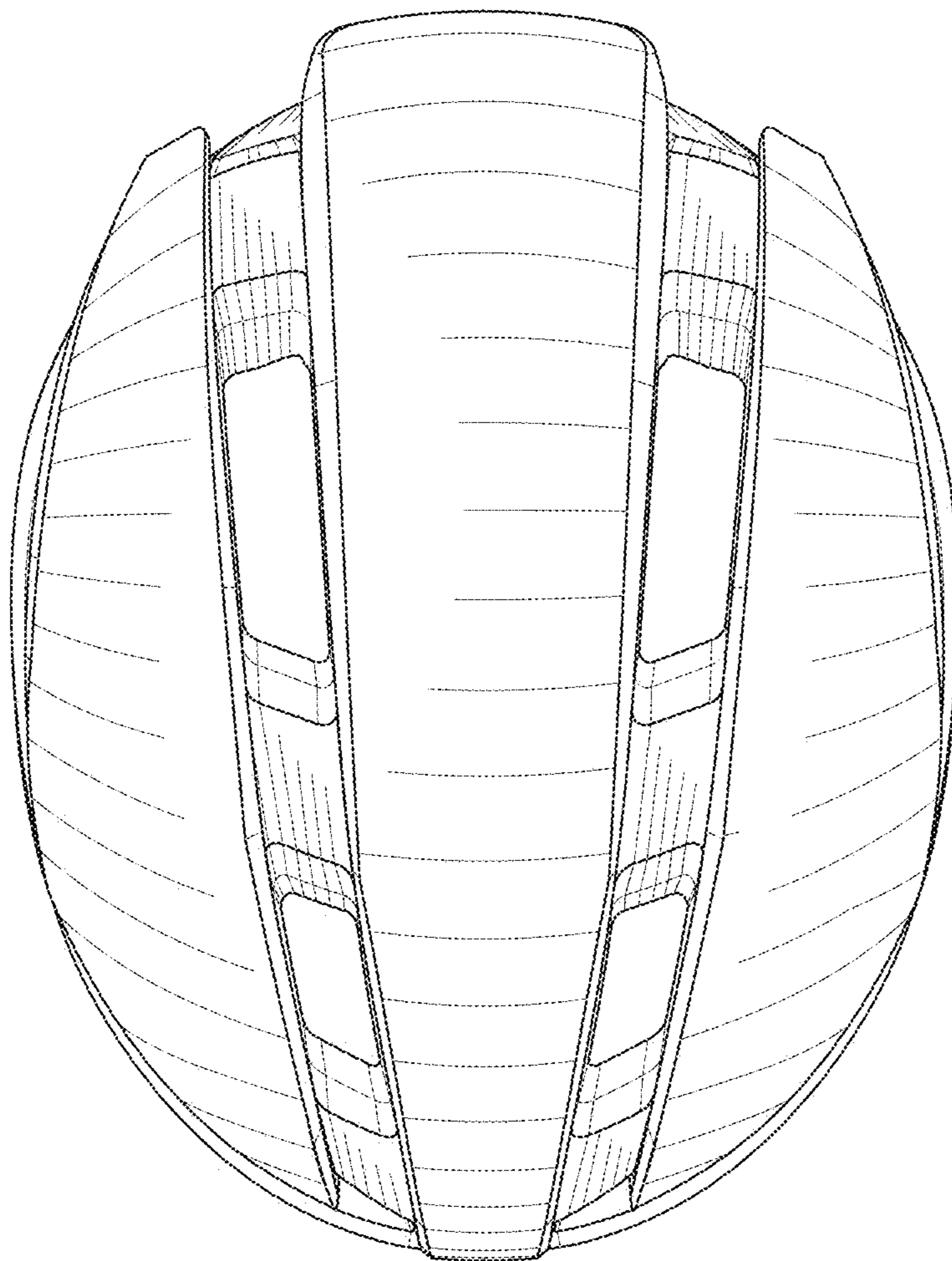

FIG. 6

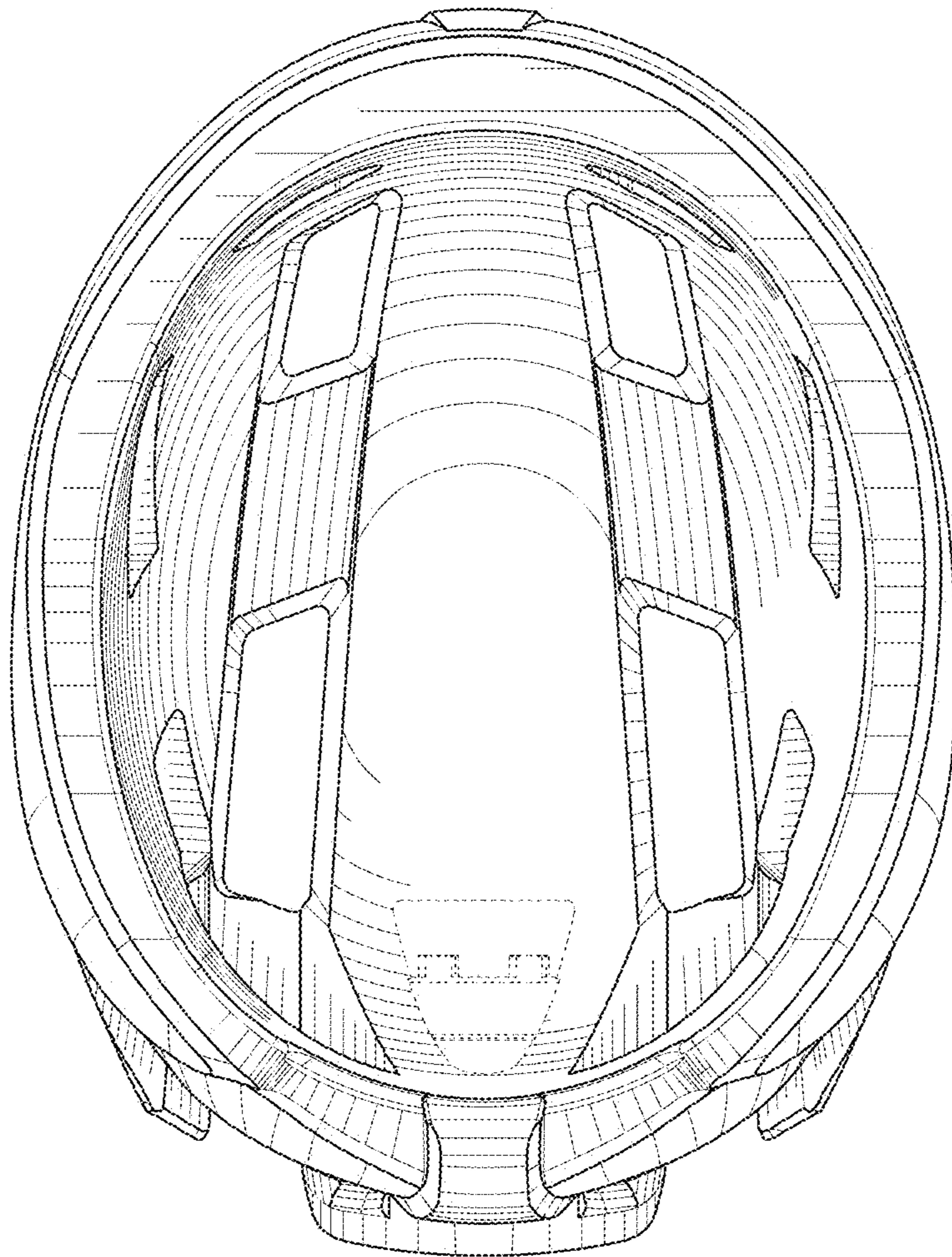

FIG. 7