



US00D965001S

(12) **United States Design Patent** (10) **Patent No.:** **US D965,001 S**
Lee (45) **Date of Patent:** **** Sep. 27, 2022**

(54) **STAND FOR STYLUS PEN**

FOREIGN PATENT DOCUMENTS

(71) Applicant: **ELAGO COMPANY CO., LTD.**,
Goyang-si (KR)

CN 203752769 U 8/2014
CN 104723739 A 6/2015

(Continued)

(72) Inventor: **Chanwoo Lee**, Goyang-si (KR)

OTHER PUBLICATIONS

(73) Assignee: **ELAGO COMPANY CO., LTD.**,
Goyang-si (KR)

TechMatte Charging Stand Compatible with Apple Pencil 1st Generation. (online) 9 pgs. Available as early as May 10, 2016. [retrieved Jul. 9, 2022] <https://www.amazon.com/TechMatte-Charging-Stand-Pencil-Built/dp/B01FEYA61Y>.*

(**) Term: **15 Years**

(Continued)

(21) Appl. No.: **29/811,339**

(22) Filed: **Oct. 13, 2021**

Primary Examiner — Marie D. Fast Horse

(51) **LOC (13) Cl.** **14-02**

(74) *Attorney, Agent, or Firm* — Paratus Law Group, PLLC

(52) **U.S. Cl.**

USPC **D14/454**

(58) **Field of Classification Search**

(57) **CLAIM**

USPC D14/411, 432, 434, 447, 454, 496, 204,
D14/216, 217, 299; D19/81, 84;
D27/136, 137; D13/107, 108
CPC G06F 1/1632; G06F 2200/1632; G06F
3/033; G06F 3/03545; B43M 99/003;
B43M 99/007; B43K 23/00; B43K
23/001; B43K 23/002; B43K 23/04;
B43K 23/08

The ornamental design for a stand for stylus pen, as shown and described.

See application file for complete search history.

DESCRIPTION

(56) **References Cited**

U.S. PATENT DOCUMENTS

D3,812 S * 1/1870 French D9/520
D45,779 S * 5/1914 Weeks D9/503
D104,660 S * 5/1937 Hanle D19/84
D199,216 S * 9/1964 Chadbourn D19/84
D270,845 S * 10/1983 Hansen D11/147
D311,027 S * 10/1990 Yuen D19/75
D367,295 S * 2/1996 Hsieh D14/454
D428,925 S * 8/2000 Brouwer D19/95
D525,306 S * 7/2006 Hirota D19/84
D553,687 S * 10/2007 Huang D19/84

FIG. 1 is a front and top side perspective view of a stand for stylus pen, showing my new design;
FIG. 2 is a front view thereof and a back view is identical;
FIG. 3 is a left side view thereof and a right side view is identical;
FIG. 4 is a top view thereof;
FIG. 5 is a bottom view thereof;
FIG. 6 is a rear and bottom side perspective view thereof; and,
FIG. 7 is a sectional view thereof taken along line 7-7 of FIG. 4.

The long dash short dash broken lines and arrows shown in FIG. 4 are used to identify the sectional view and form no part of the claimed design. The evenly spaced broken lines in FIG. 7 represent hatching lines and form no part of the claimed design.

1 Claim, 7 Drawing Sheets

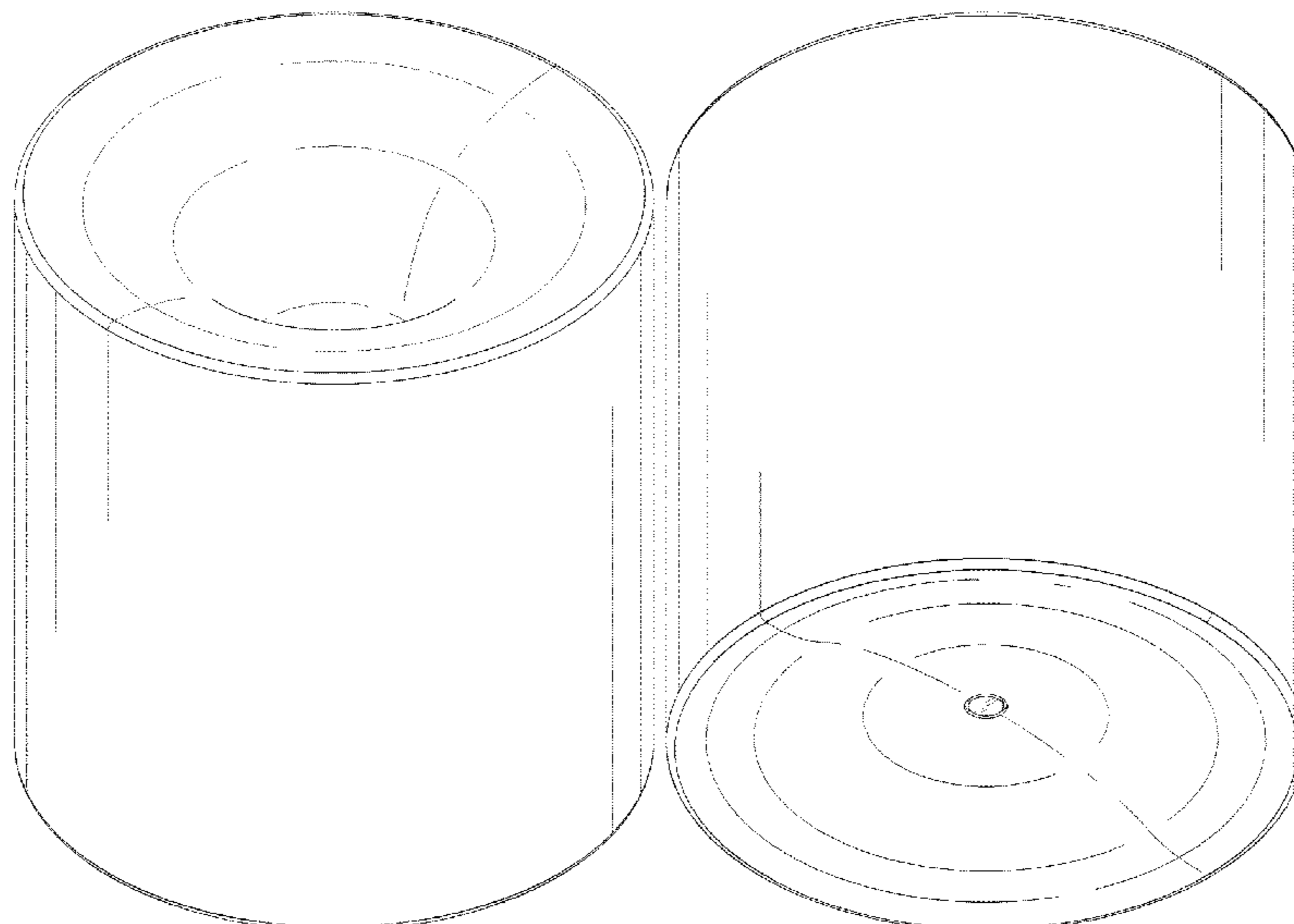

(56)

References Cited

U.S. PATENT DOCUMENTS

D570,416 S * 6/2008 Hackenberg D19/83
 D624,966 S * 10/2010 Crisp D19/85
 D789,373 S * 6/2017 King D14/413
 D789,374 S * 6/2017 King D14/413
 D797,190 S * 9/2017 Laemle D19/84
 D819,737 S * 6/2018 Wei D19/84
 D838,313 S * 1/2019 Park D19/135
 10,391,808 B2 8/2019 Mitchell
 D870,040 S * 12/2019 Wu D13/108
 D885,397 S * 5/2020 Sun D14/434
 10,698,508 B2 6/2020 Kim
 D916,656 S * 4/2021 Choe D27/183
 D936,577 S * 11/2021 Huang D13/108
 D940,074 S * 1/2022 Bae D13/108
 2012/0162059 A1 * 6/2012 Chuang G06F 3/03542
 345/156
 2016/0023500 A1 1/2016 Wang

FOREIGN PATENT DOCUMENTS

CN 204432078 U 7/2015
 CN 304089720 3/2017
 CN 305071489 5/2019

JP D1118676 8/2001
 JP 2017100354 A 6/2017
 KR 20-0178320 Y1 4/2000
 KR 301044312.0000 * 2/2020
 SG 2010363F-0001 7/2010

OTHER PUBLICATIONS

Stylus Allure Wood Stand. (online) 6 pgs. Available as early as Apr. 13, 2013. [retrieved Jul. 9, 2022] https://www.amazon.com/Stylus-Allure-iPhone-Galaxy-Replaceable/dp/B00QIESH2A?ref_=ast_sto_dp&th=1.*

Cylinder shape Holder 3D Printed for apple pencil. (online) 10 pgs. [retrieved Jul. 9, 2022] https://www.etsy.com/listing/1144007900/cylinder-shape-holder-3d-printed-for?click_key=60edc5d94883dbc19dcaa40e9545a773f929c5da%3A1144007900&click_sum=604f25de&ref=shop_home_recs_1&pro=1.*

Belkin Apple Pencil Base Stand Holder for Apple Pencil. (online) 7 pgs. Available as early as Oct. 6, 2021. [retrieved Jul. 9, 2022] <https://www.ebay.com/itm/264518482878>.*

Pen on the tablet on a stand in the studio on a white background. (online) 4 pgs. Date Taken Feb. 2, 2012. [retrieved Jul. 9, 2022] <https://www.alamy.com/stock-photo-pen-on-the-tablet-on-a-stand-in-the-studio-on-a-white-background-43885435.html>.*

* cited by examiner

FIG. 1

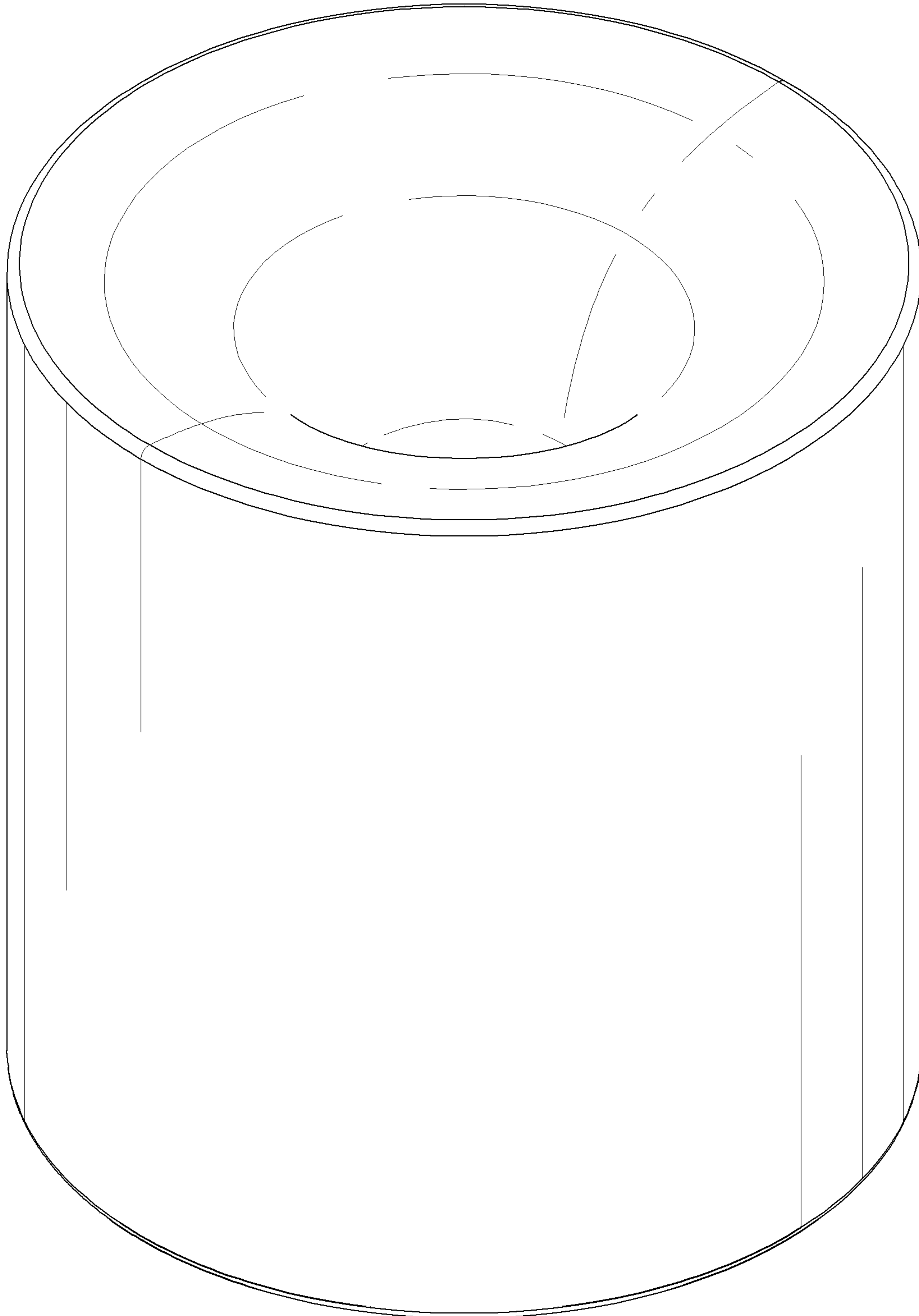

FIG. 2

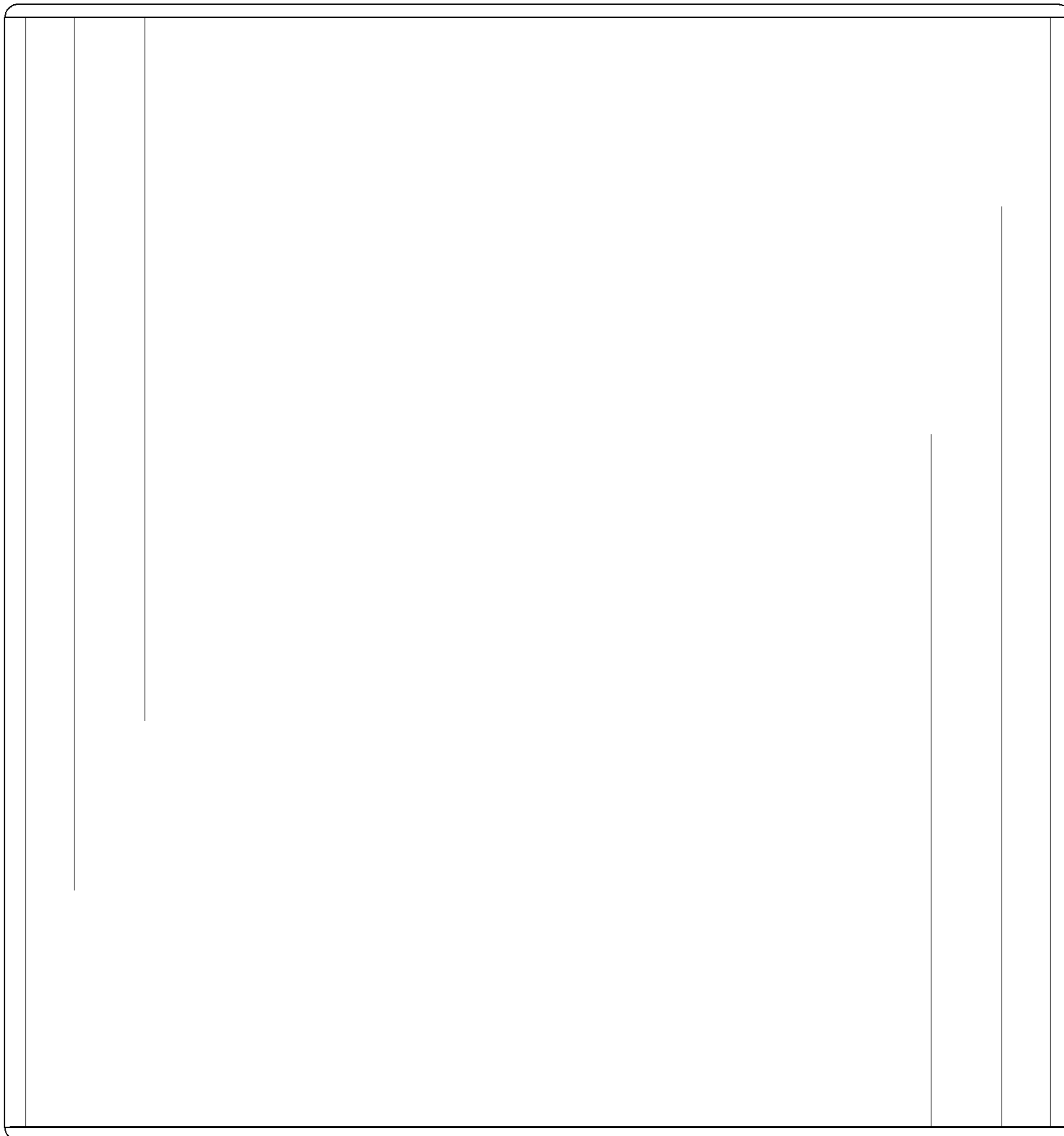

FIG. 3

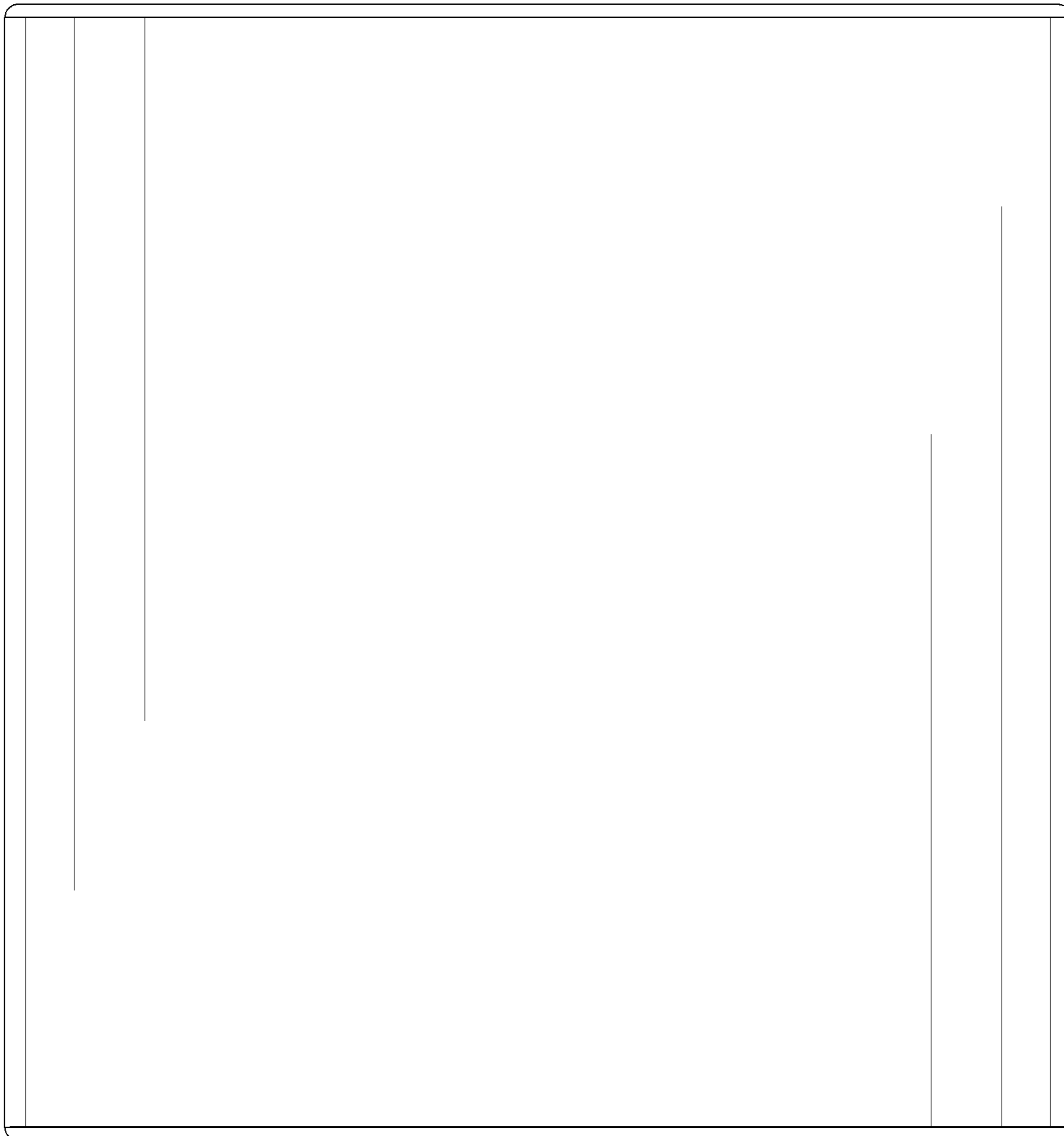

FIG. 4

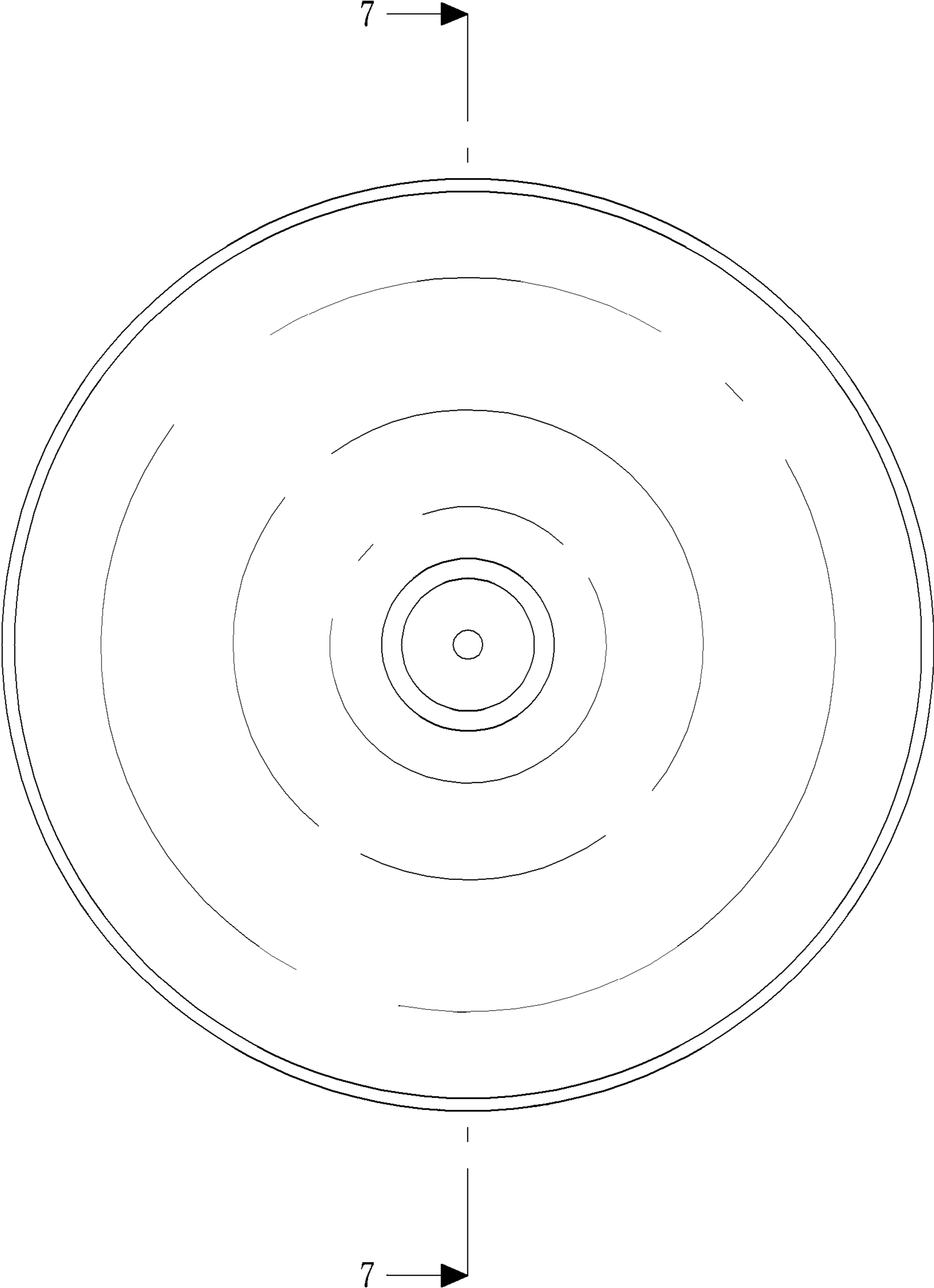

FIG. 5

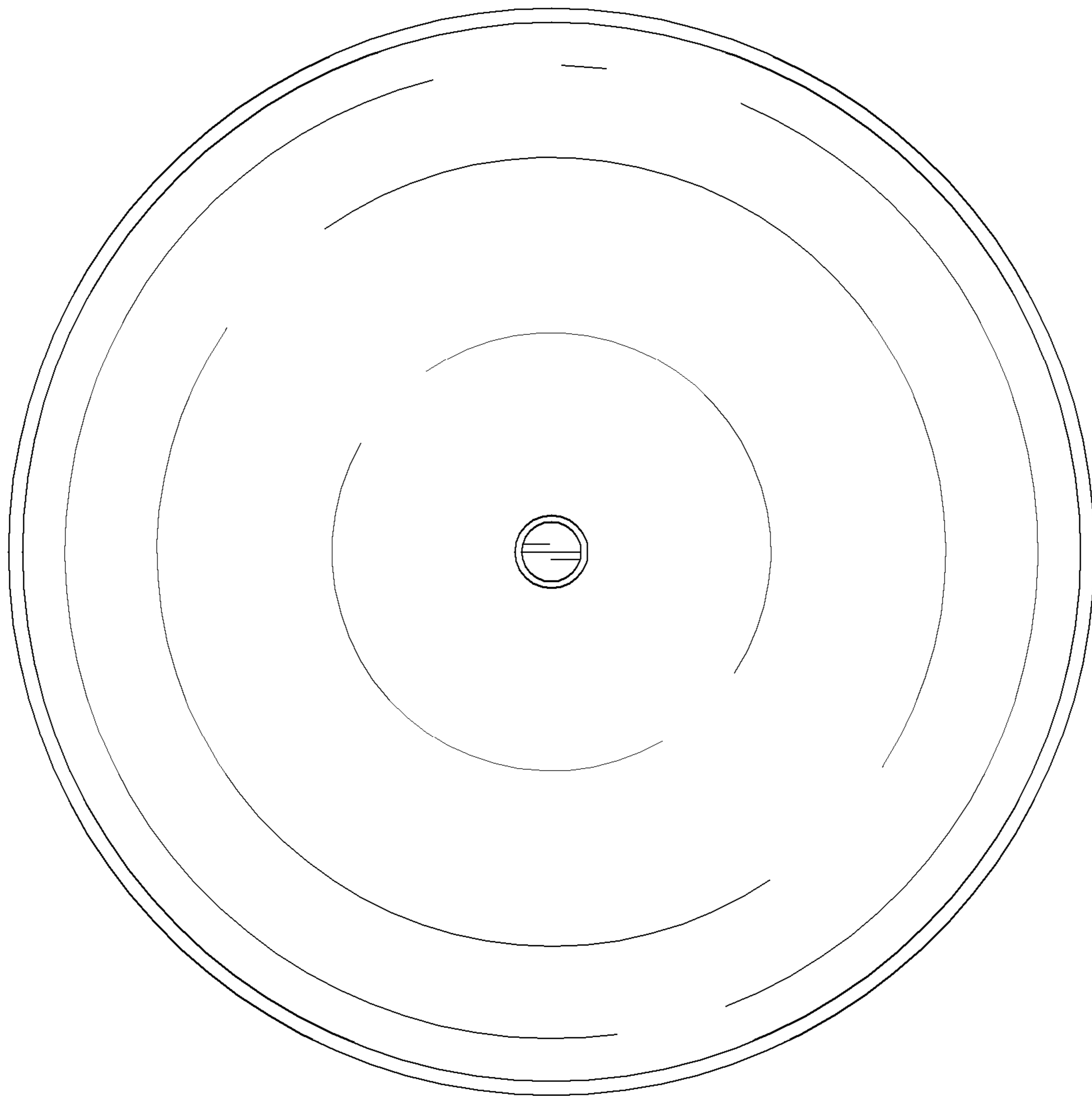

FIG. 6

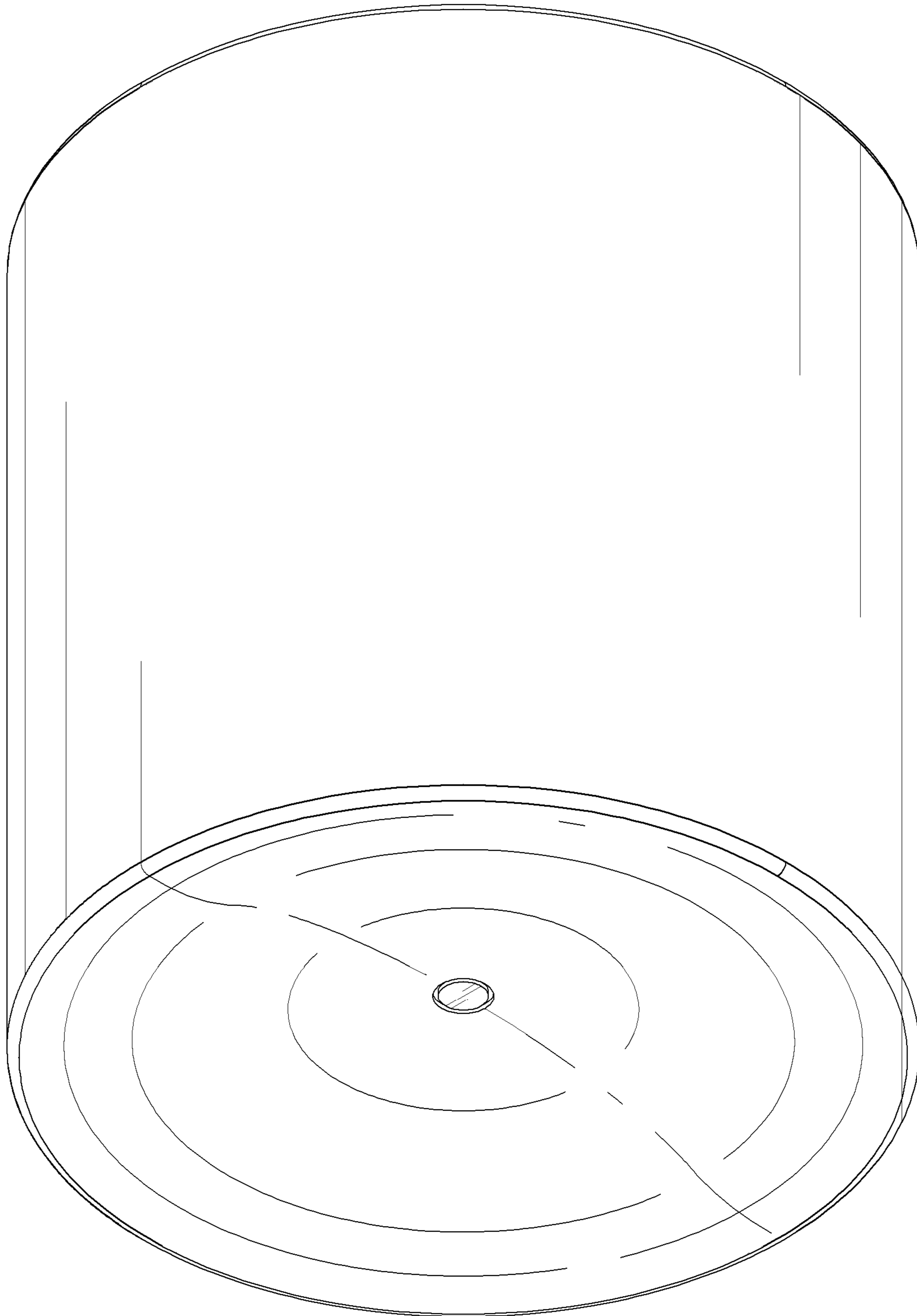

FIG. 7

