

US00D964953S

(12) **United States Design Patent** (10) **Patent No.:** **US D964,953 S**
Min et al. (45) **Date of Patent:** **** *Sep. 27, 2022**

(54) **MOBILE PHONE**

- (71) Applicant: **LG ELECTRONICS INC.**, Seoul (KR)
- (72) Inventors: **Jinki Min**, Seoul (KR); **Hongkyu Park**, Seoul (KR); **Jonghak Lee**, Seoul (KR); **Seunghyun Ji**, Seoul (KR); **Sojin Kim**, Seoul (KR)
- (73) Assignee: **LG ELECTRONICS INC.**, Seoul (KR)

(*) Notice: This patent is subject to a terminal disclaimer.

(**) Term: **15 Years**

(21) Appl. No.: **29/735,003**

(22) Filed: **May 18, 2020**

(30) **Foreign Application Priority Data**

Nov. 20, 2019 (JP) 2019-025767

(51) **LOC (13) Cl.** **14-03**

(52) **U.S. Cl.**
USPC **D14/138 AD**

(58) **Field of Classification Search**
USPC D14/137, 496, 138 R, 138 AA, 138 AB, D14/138 AC, 138 AD, 138 C, 138 G,
(Continued)

(56) **References Cited**

U.S. PATENT DOCUMENTS

D631,458 S * 1/2011 Liao D14/138 G
D636,752 S * 4/2011 Liao D14/138 G
(Continued)

FOREIGN PATENT DOCUMENTS

GB 8203667000-1000 * 5/2019
IN 269850-0001 * 7/2015

OTHER PUBLICATIONS

Samsung Device Patents, www.patentlymobile.com, Jan. 12, 2018. <https://www.patentlymobile.com/2018/01/samsung-device-patents-published-this-week-cover-display-devices-that-are-rollable-foldable-and-stretchable.html> (Year: 2018).*

(Continued)

Primary Examiner — Llorellys Martinez

Assistant Examiner — Kwabena A. Ankobiah

(74) *Attorney, Agent, or Firm* — Birch, Stewart, Kolasch & Birch, LLP

(57) **CLAIM**

The ornamental design for a mobile phone, as shown and described.

DESCRIPTION

FIG. 1 is a front perspective view of the mobile phone showing our new design;
FIG. 2 is a front view thereof;
FIG. 3 is a rear view thereof;
FIG. 4 is a left side view thereof;
FIG. 5 is a right side view thereof;
FIG. 6 is a top plan view thereof;
FIG. 7 is a bottom plan view thereof;
FIG. 8 is a rear perspective view thereof;
FIG. 9 is another rear perspective view thereof, showing the mobile phone where a graphic is displayed;
FIG. 10 is another front perspective view thereof, showing the mobile phone of FIG. 1 in an alternate configuration;
FIG. 11 is a front view of FIG. 10;
FIG. 12 is a rear view of FIG. 10;
FIG. 13 is a left side view of FIG. 10;
FIG. 14 is a right side view of FIG. 10;
FIG. 15 is a top plan view of FIG. 10;
FIG. 16 is a bottom plan view of FIG. 10; and,
FIG. 17 is a rear perspective view of FIG. 10.

The broken lines in the drawing depict portions of the mobile phone that form no part of the claim. The other

(Continued)

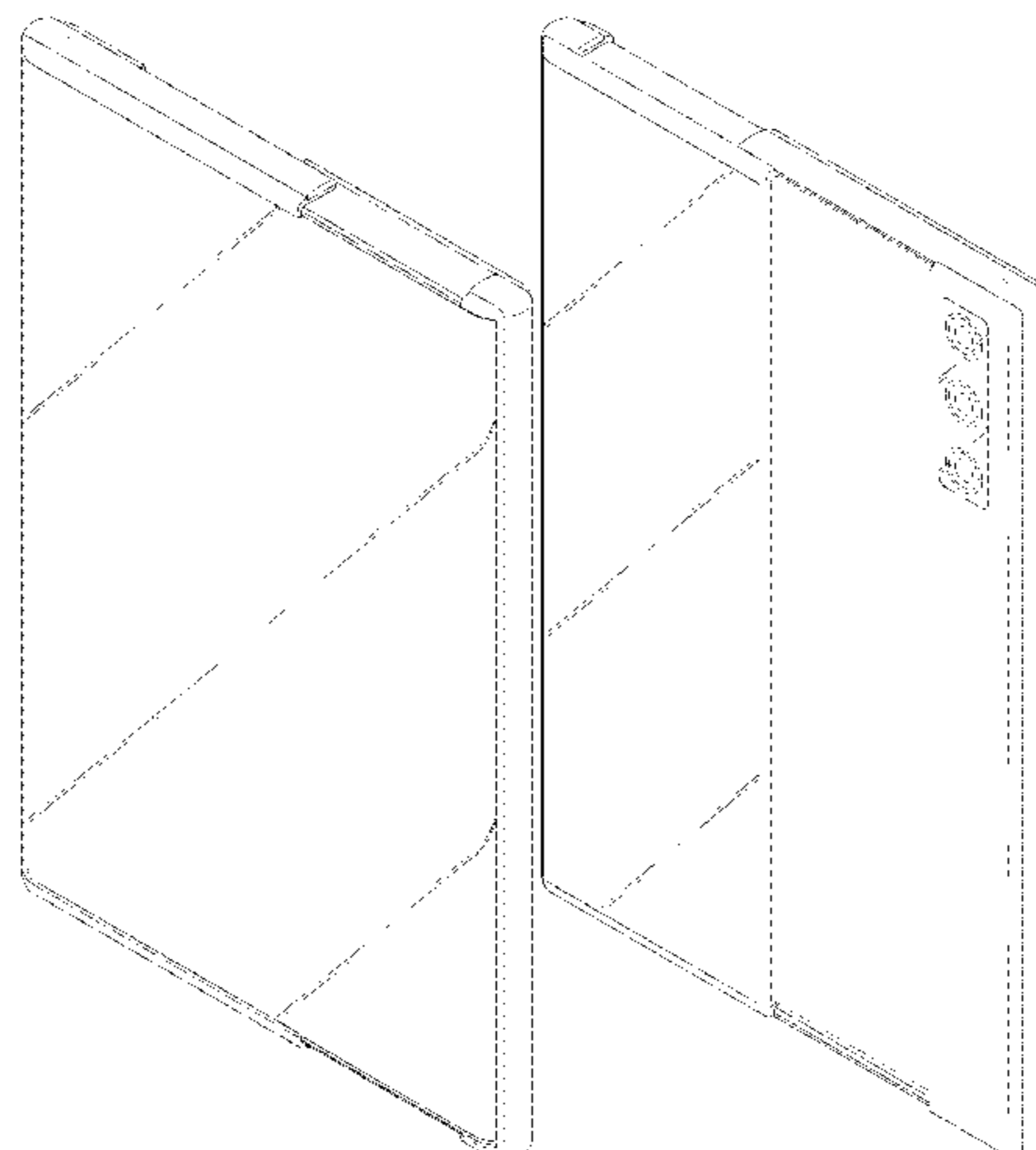

broken lines in FIG. 9, showing a graphic, represent environmental subject matter only and form no part of the claimed design.

1 Claim, 17 Drawing Sheets

(58) Field of Classification Search

USPC ... D14/203.1, 203.3, 203.4, 203.7, 426, 348, D14/342, 341, 388, 389, 248, 218, 432, D14/439; D6/308; D10/50; D21/329; D13/103, 107
 CPC G06F 3/041; G06F 3/0412; G06F 3/0488; G06F 3/04883; G06F 1/1613; G06F 1/1626; G06F 1/1692; G06F 2200/1633; H04M 1/0202; H04M 1/0235; H04M 1/0237; H04M 1/0239; H04M 1/0266; H04M 1/0268; H04M 1/027; H04M 1/0295; H04M 1/02; H04M 1/0279; H04M 1/0283

See application file for complete search history.

(56) References Cited

U.S. PATENT DOCUMENTS

D712,401	S	*	9/2014	Lee	D14/341
D722,036	S	*	2/2015	Nam	D14/138 G
D722,037	S	*	2/2015	Nam	D14/138 G
D726,674	S	*	4/2015	Lee	D14/138 G
D737,794	S	*	9/2015	Lee	D14/138 G
D747,301	S	*	1/2016	Lee	D14/248
D761,251	S	*	7/2016	Senda	D14/341
D761,253	S	*	7/2016	Yamazaki	D14/341
D761,788	S	*	7/2016	Yamazaki	D14/341
D761,790	S	*	7/2016	Yamazaki	D14/341
D763,188	S	*	8/2016	Park	D13/108
D768,594	S	*	10/2016	Szeto	D14/138 G
D780,179	S	*	2/2017	Bae	D14/374
D784,945	S	*	4/2017	Choo	D14/138 AB
D789,902	S	*	6/2017	Park	D14/138 G
D789,922	S	*	6/2017	Yamazaki	D14/341
D790,497	S	*	6/2017	Kim	D14/138 AA
D795,825	S	*	8/2017	Kim	D14/138 R
D803,828	S	*	11/2017	Yamazaki	D14/341
D812,605	S	*	3/2018	Senda	D14/341
D812,606	S	*	3/2018	Senda	G09F 9/301 D14/341
D819,022	S	*	5/2018	Shim	D14/363
D829,719	S	*	10/2018	Shim	D14/435
D838,270	S	*	1/2019	Cho	D14/341
D840,394	S	*	2/2019	Son	D14/345

10,884,460	B2	*	1/2021	Lin	G06F 1/1652
10,904,371	B1	*	1/2021	Song	G06F 1/1652
D912,045	S	*	3/2021	Han	D14/341
10,955,876	B1	*	3/2021	Song	G06F 1/1656
10,963,014	B1	*	3/2021	Park	H04B 1/3827
10,963,016	B1	*	3/2021	Oh	G06F 1/1652
10,972,592	B2	*	4/2021	Song	G06F 1/1652
10,976,775	B1	*	4/2021	Cha	G06F 1/1652
11,003,219	B1	*	5/2021	Kim	G06F 1/1624
D923,598	S	*	6/2021	Lee	H04M 1/0268 D14/138 AD
D924,216	S	*	7/2021	Ryu	D14/248
D926,718	S	*	8/2021	Lee	G06F 1/1624 D14/138 AD
D926,754	S	*	8/2021	Han	D14/138 AD
D928,108	S	*	8/2021	Huang	D14/138 AB
D933,625	S	*	10/2021	Lee	D14/138 AD
D936,625	S	*	11/2021	Lee	D14/138 AD
D936,626	S	*	11/2021	Lee	D14/138 AD
D936,627	S	*	11/2021	Lee	D14/138 AD
11,165,897	B2	*	11/2021	Song	G06F 1/1622
2018/0102072	A1	*	4/2018	Lee	G09F 9/301
2021/0044683	A1	*	2/2021	He	G06F 1/1624
2021/0099557	A1	*	4/2021	Cha	H04M 1/0268
2021/0120111	A1	*	4/2021	Choi	G06F 1/1624
2021/0166651	A1	*	6/2021	Shim	G06F 1/1652
2021/0185835	A1	*	6/2021	Song	H05K 5/0017
2021/0195009	A1	*	6/2021	Choi	H04M 1/0233
2021/0218835	A1	*	7/2021	Song	H04M 1/0268
2021/0223952	A1	*	7/2021	Oh	G06F 3/04886
2021/0278878	A1	*	9/2021	Shim	G06F 1/1677
2021/0326569	A1	*	10/2021	Song	G06F 1/1681
2021/0329106	A1	*	10/2021	Song	H04M 1/0241
2021/0336356	A1	*	10/2021	Choi	G06F 1/1698
2021/0337049	A1	*	10/2021	Noh	G06F 3/04883
2021/0352813	A1	*	11/2021	Cho	G06F 1/1683
2021/0359392	A1	*	11/2021	Won	H04M 1/0237

OTHER PUBLICATIONS

Xiaomi Mi MIX Alpha 2, www.concept-phones.com, Oct. 15, 2019. <https://www.concept-phones.com/xiaomi/xiaomi-mi-mix-alpha-2-becomes-a-scroll-and-expandable-phone-in-this-video-trailer/> (Year: 2019).*

Leaked images of TCL's concept smartphone, www.talkandroid.com, Feb. 18, 2020. <https://www.talkandroid.com/349932-tcl-concept-slide-out-display/> (Year: 2020).*

Xiaomi Rollable smartphone with retractable screen, en.letsgodigital.org, Dec. 11, 2020. <https://en.letsgodigital.org/smartphones/xiaomi-rollable-smartphone/> (Year: 2020).*

LG Rollable phone, www.phonearena.com, Aug. 12, 2021. <https://www.phonearena.com/lg-rollable-phone-release-date-price-features-news> (Year: 2021).*

* cited by examiner

FIG. 1

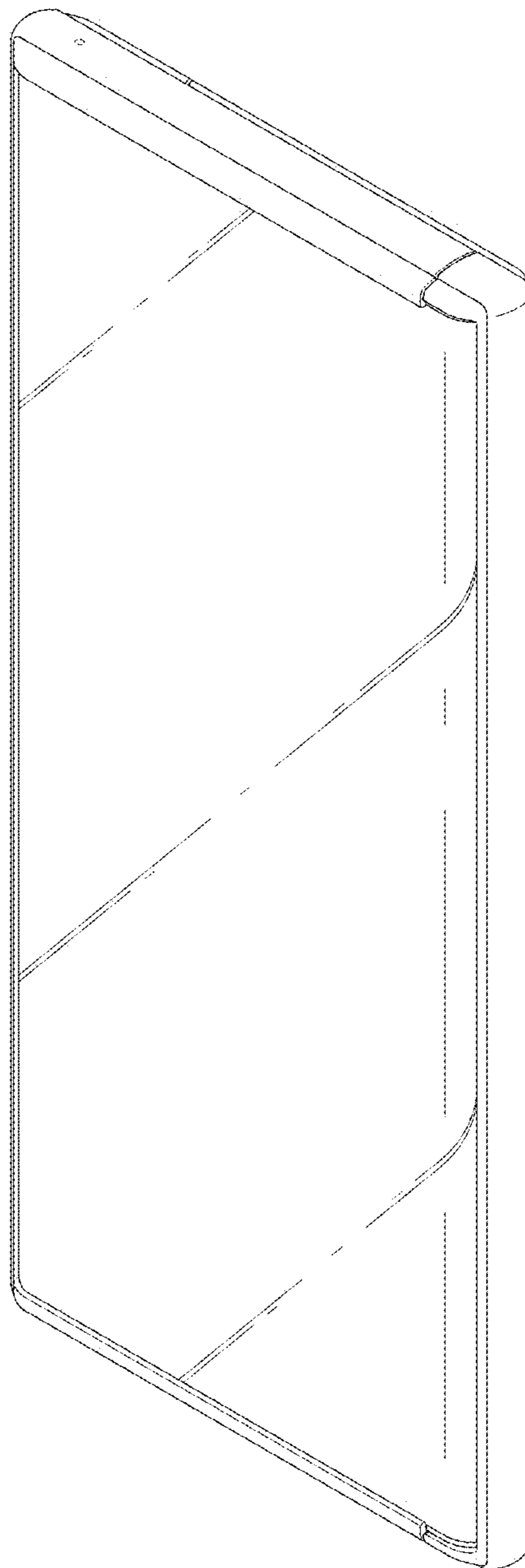

FIG. 2

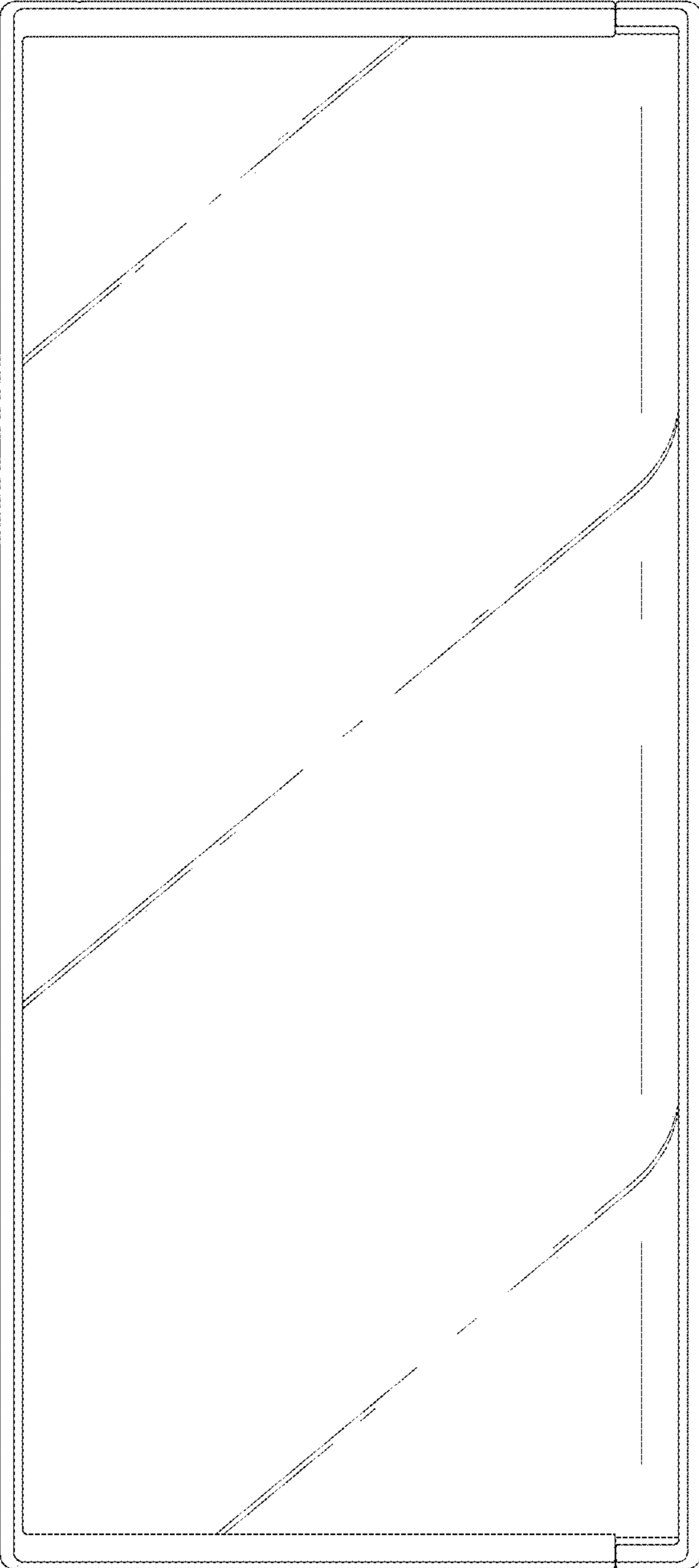

FIG. 3

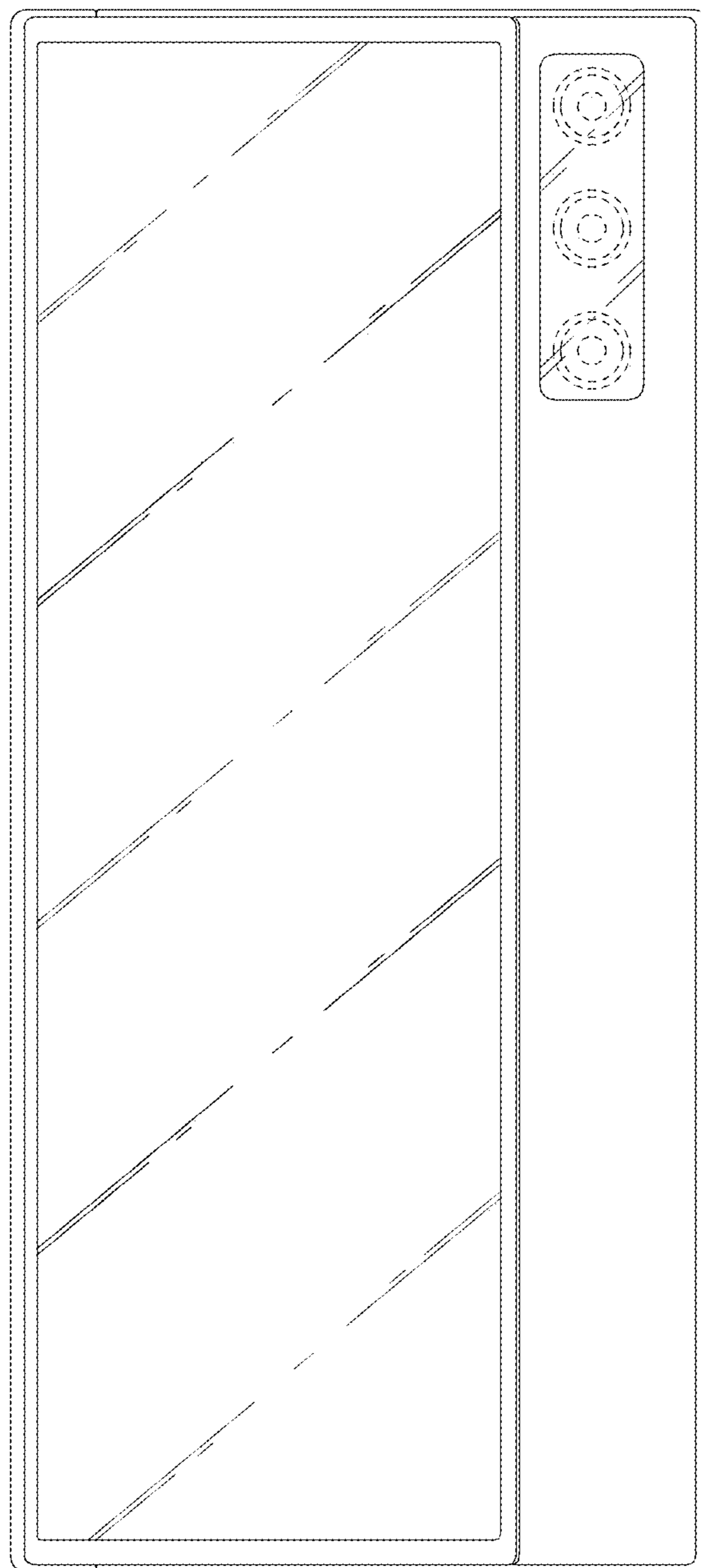

FIG. 4

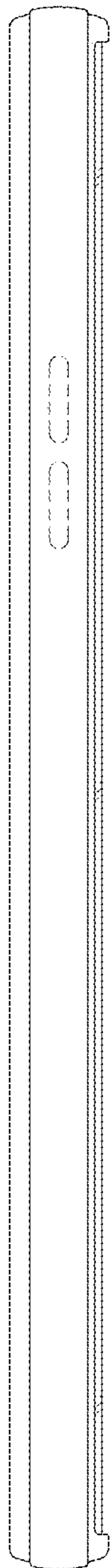

FIG. 5

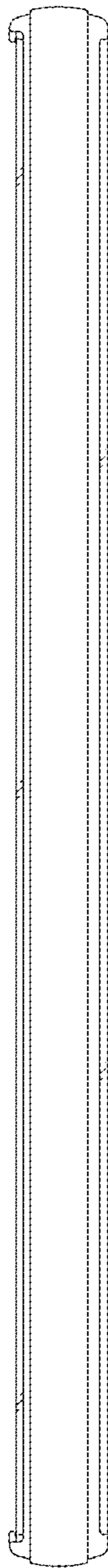

FIG. 6

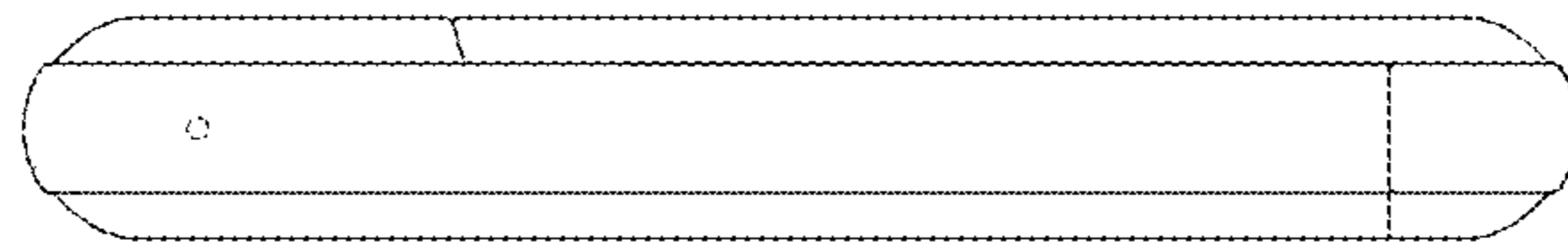

FIG. 7

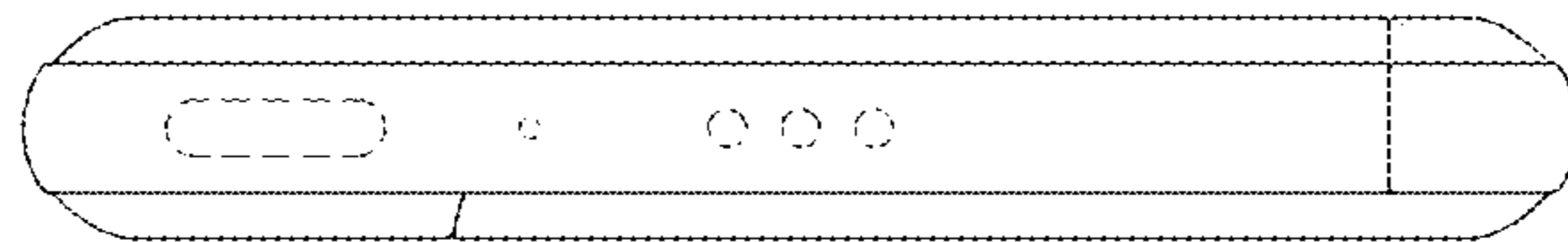

FIG. 8

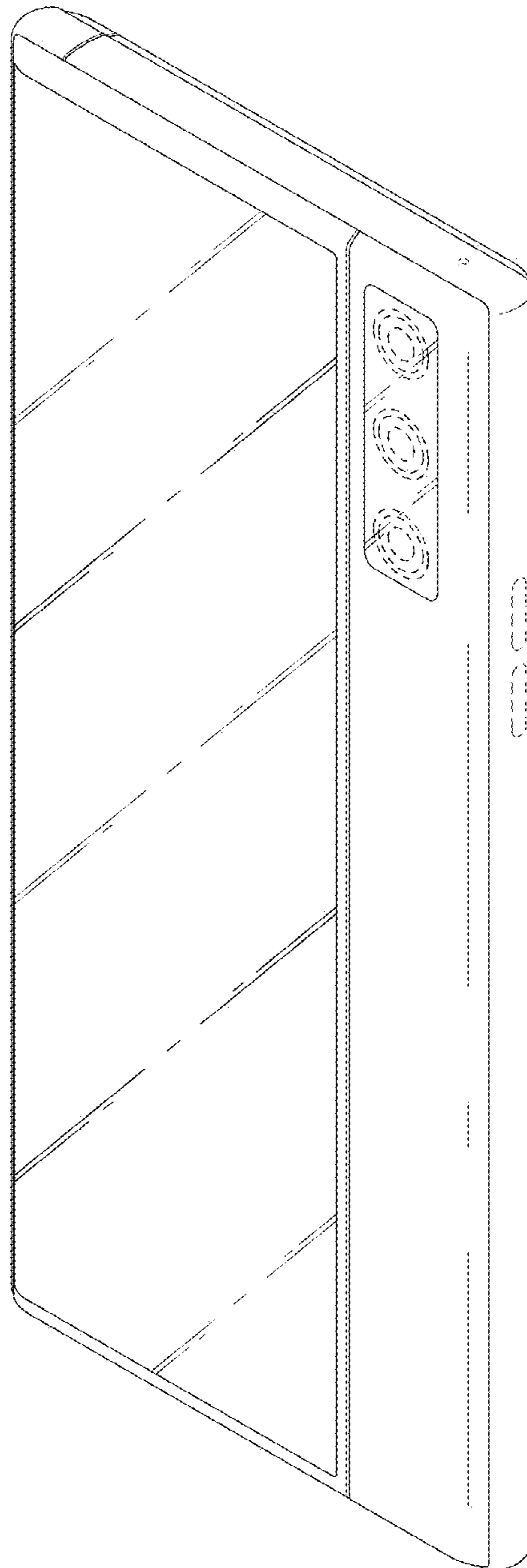

FIG. 9

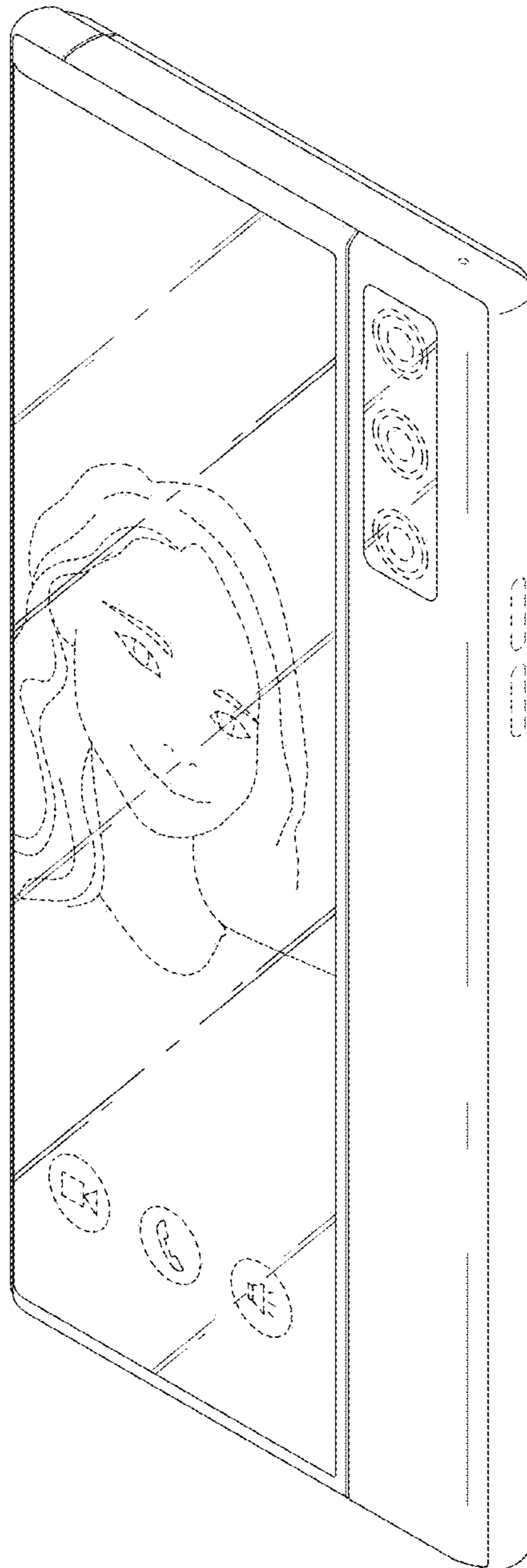

FIG. 10

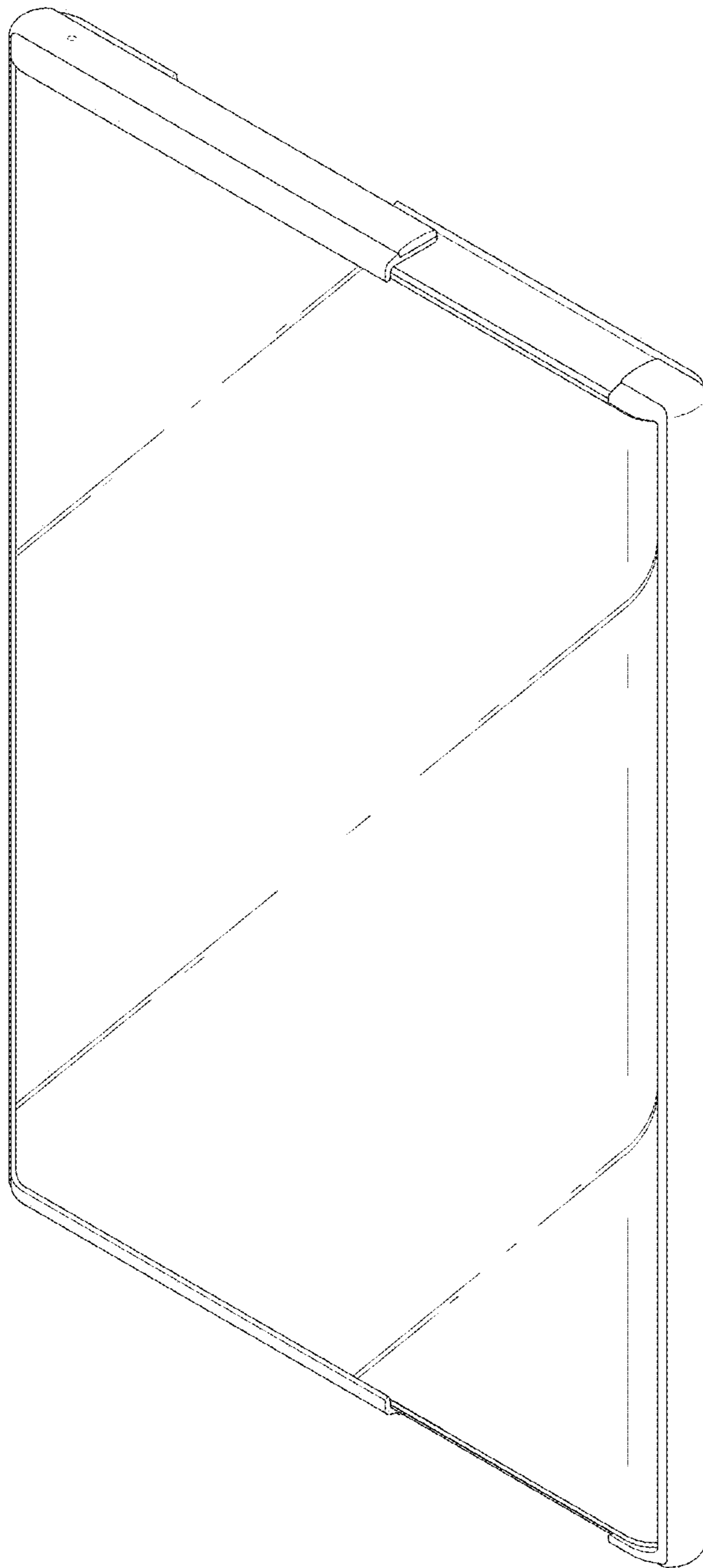

FIG. 11

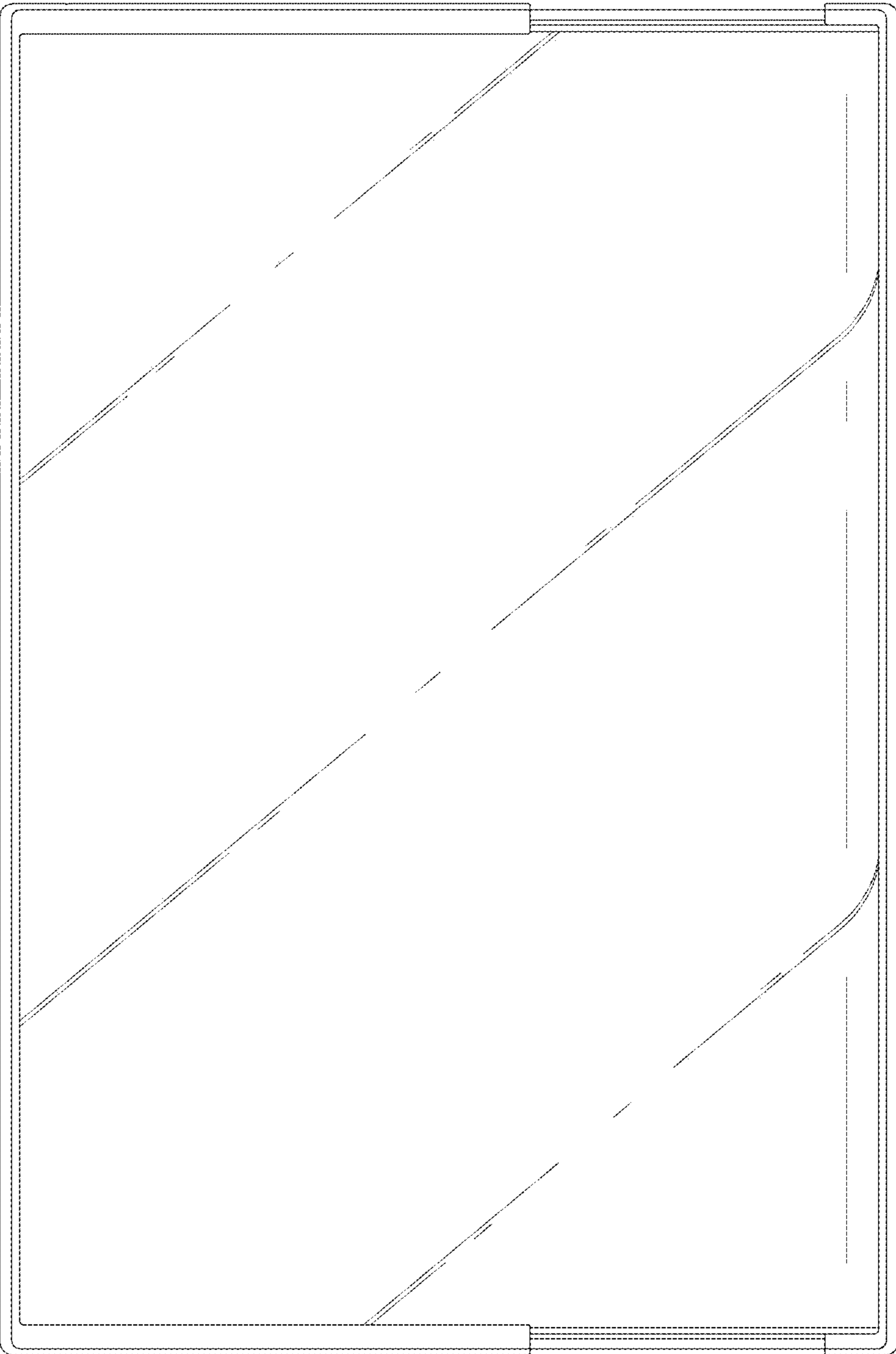

FIG. 12

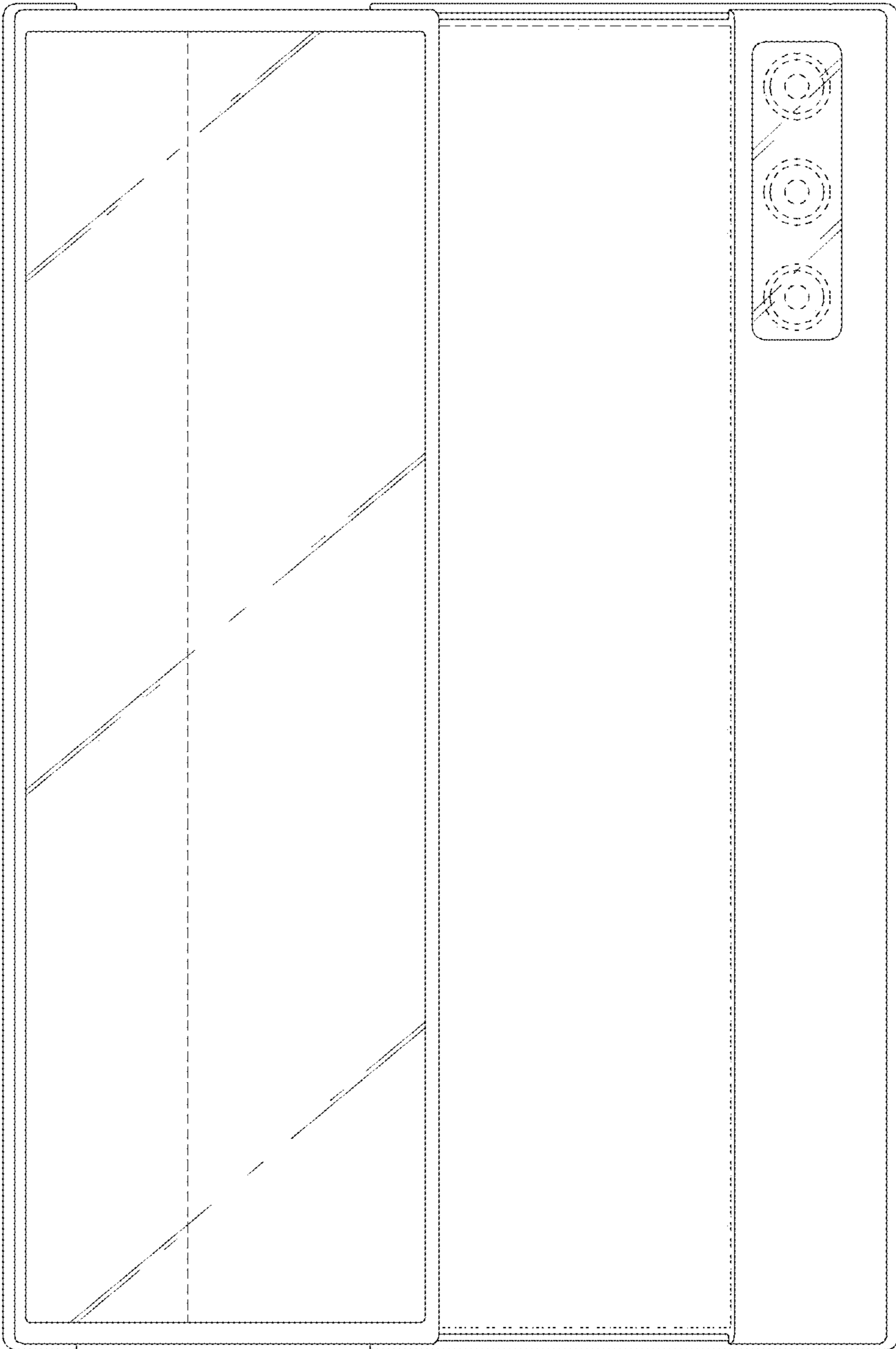

FIG. 13

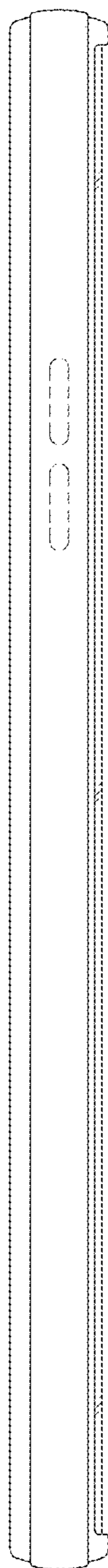

FIG. 14

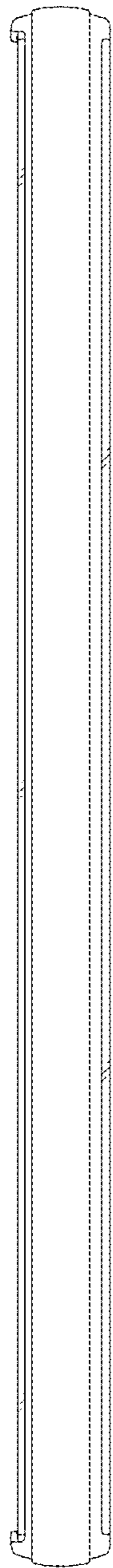

FIG. 15

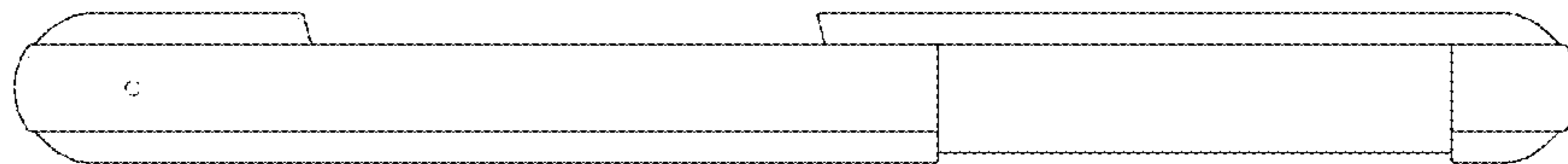

FIG. 16

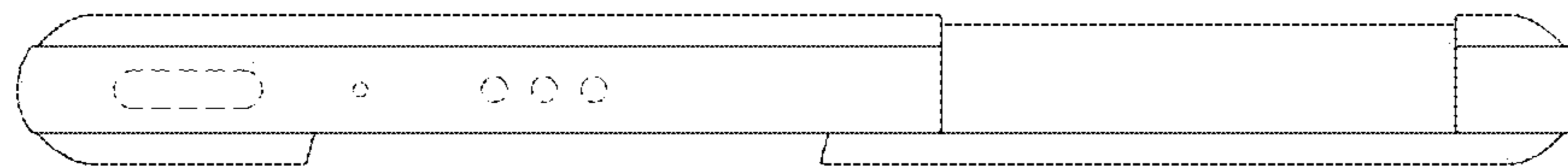

FIG. 17

