

US00D964889S

(12) **United States Design Patent** (10) **Patent No.:** **US D964,889 S**
Ghosh et al. (45) **Date of Patent:** **** Sep. 27, 2022**

(54) **MOTOR VEHICLE**

(56) **References Cited**

(71) Applicant: **Keller Motors LLC**, Stanford, CA (US)
 (72) Inventors: **Tathagata Ghosh**, Kalyani (IN); **Brandon Phillip Madison Jones**, Reno, NV (US); **Taylor Michael Keller**, Stanford, CA (US)

U.S. PATENT DOCUMENTS

D729,285 S *	5/2015	Seo et al.	D12/91
D800,018 S *	12/2017	Wheel	D12/91
D813,725 S *	3/2018	Filippini et al.	D12/91
D833,911 S *	5/2018	Frascella	D12/91
D844,489 S *	4/2019	Alexiev	D12/91
D915,239 S *	4/2021	Cattabriga et al.	D12/91

* cited by examiner

(73) Assignee: **Keller Motors LLC**, Stanford, CA (US)

Primary Examiner — Melody N Brown

(74) *Attorney, Agent, or Firm* — Jason C. Cameron

(**) Term: **15 Years**

(57) **CLAIM**

The ornamental design of a motor vehicle, as shown and described.

(21) Appl. No.: **29/740,360**

DESCRIPTION

(22) Filed: **Jul. 2, 2020**

(51) **LOC (13) Cl.** **12-08**

(52) **U.S. Cl.**
USPC **D12/88**

(58) **Field of Classification Search**
 USPC D12/86, 90-92, 164, 83, 87; D21/433, D21/434, 531-535, 550; 296/181.1-181.5, 183.1
 CPC B62D 25/00; B62D 25/06; B62D 33/00; B62D 35/00

FIG. 1 is a REAR elevational view of a motor vehicle showing our new design;
 FIG. 2 is a FRONT elevational view thereof;
 FIG. 3 is a TOP plan view thereof;
 FIG. 4 is a SIDE elevational view thereof, the opposite being a mirror image of that side shown;
 FIG. 5 is a BOTTOM plan view thereof;
 FIG. 6 is a FRONT PERSPECTIVE view thereof; and,
 FIG. 7 is a REAR PERSPECTIVE view thereof.

See application file for complete search history.

1 Claim, 7 Drawing Sheets

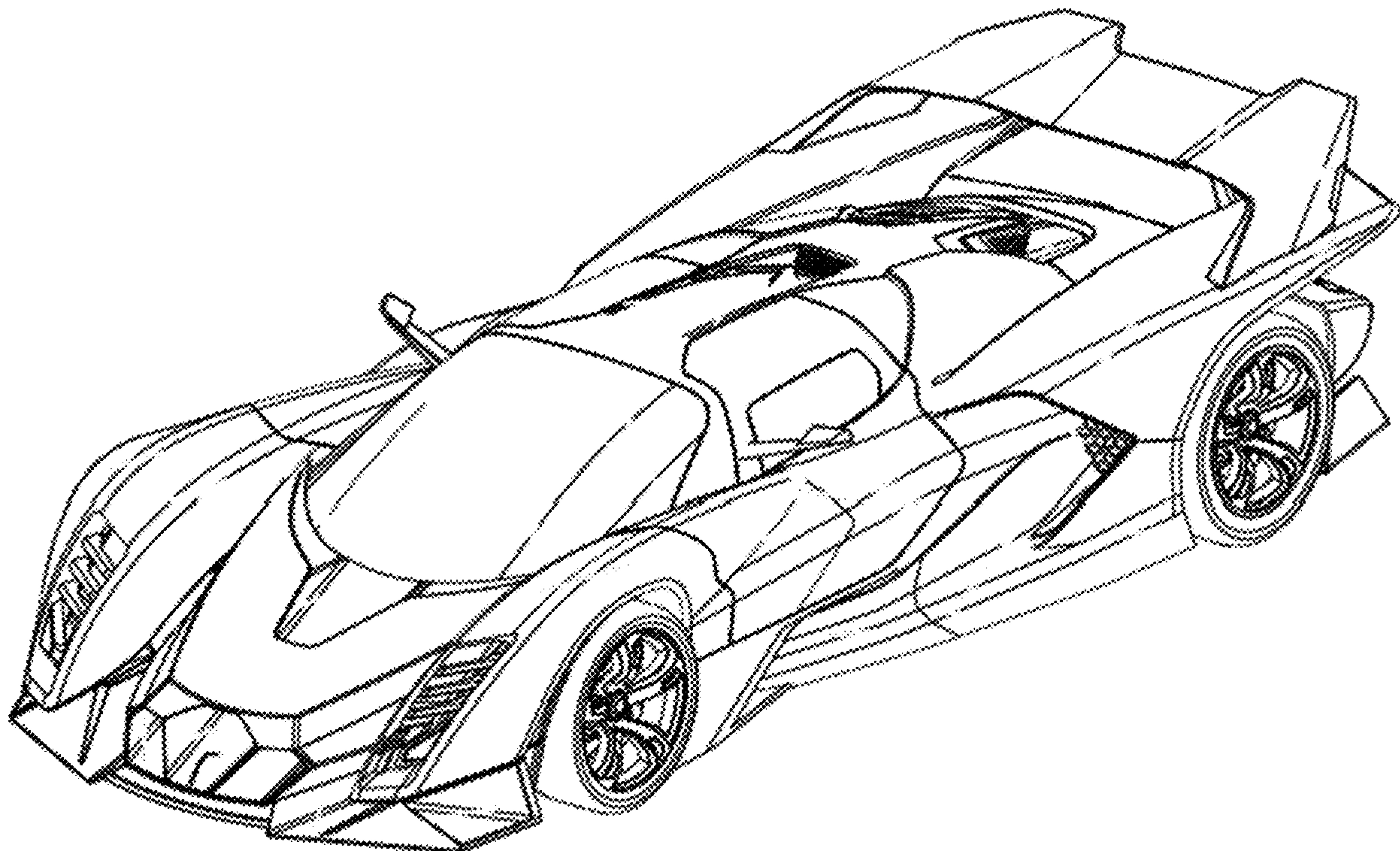

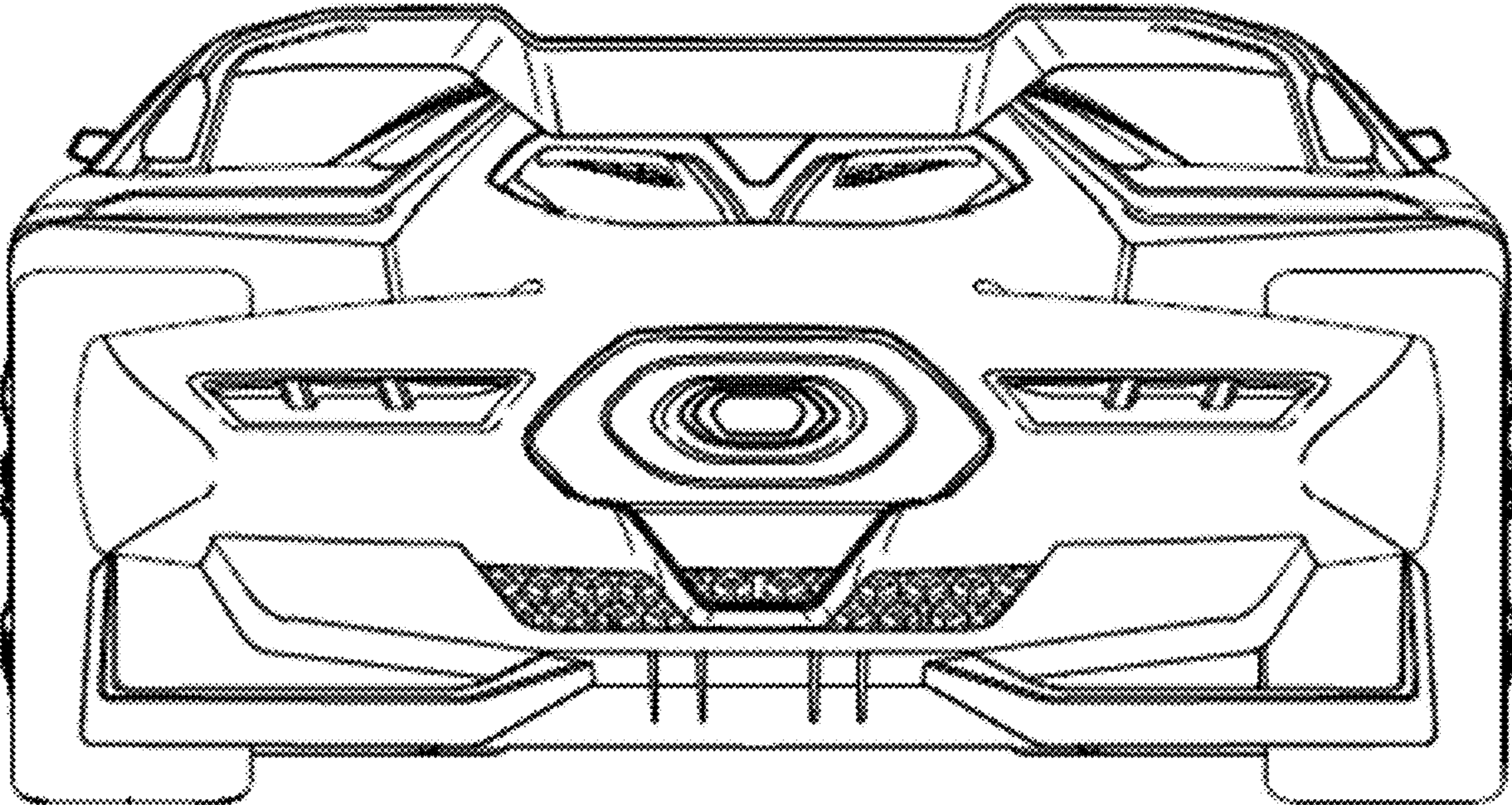

FIG. 1

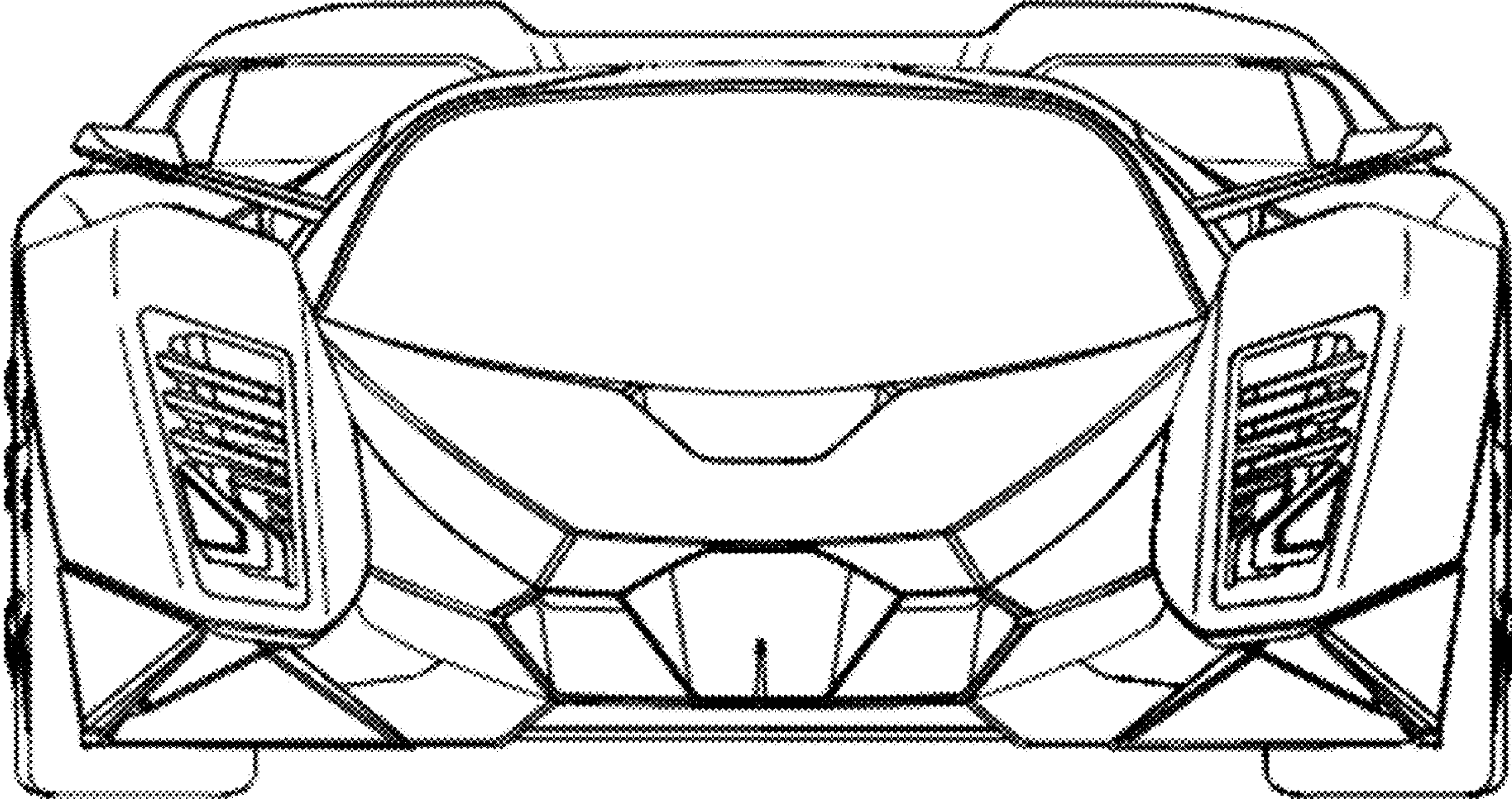

FIG. 2

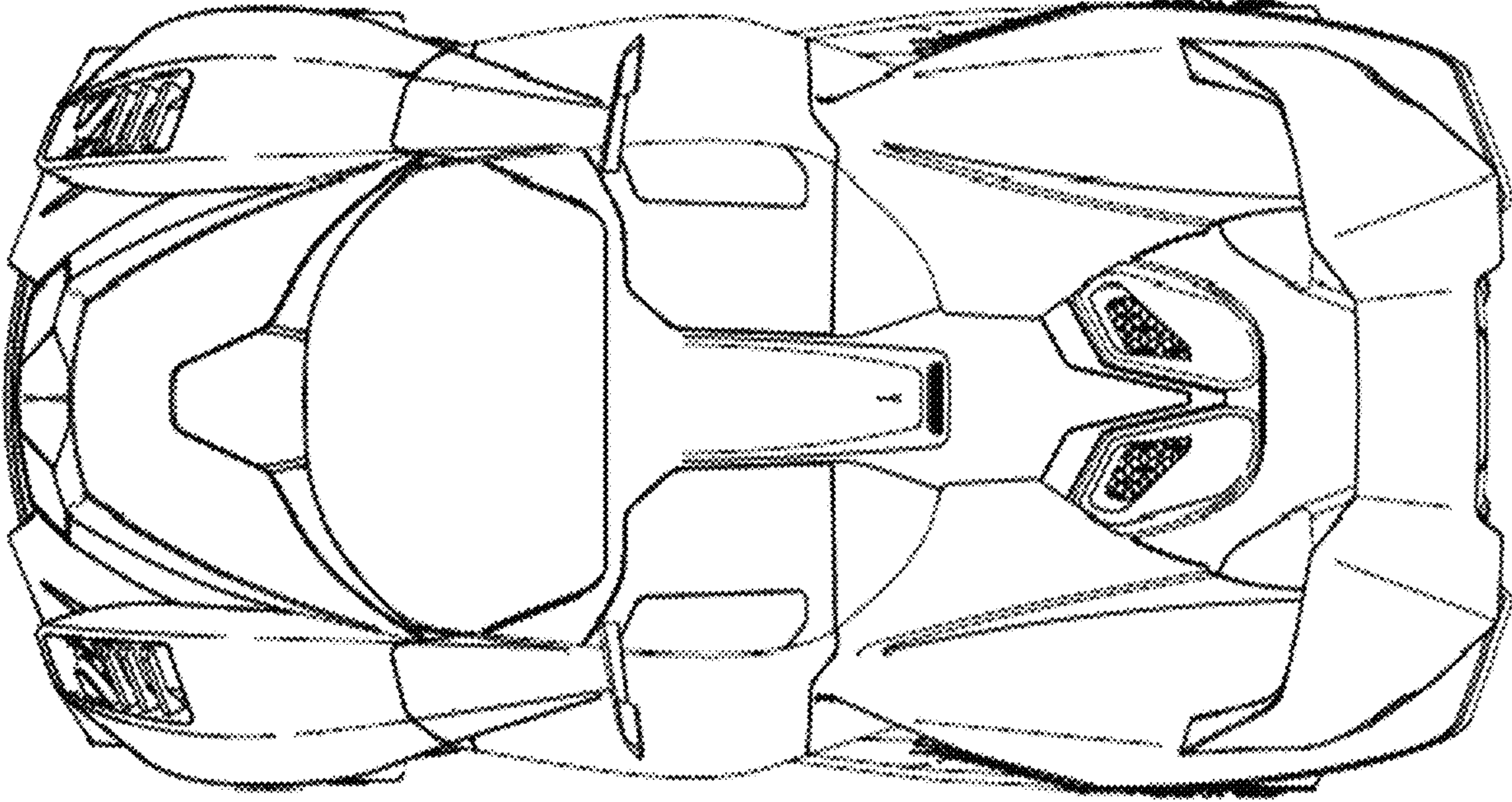

FIG. 3

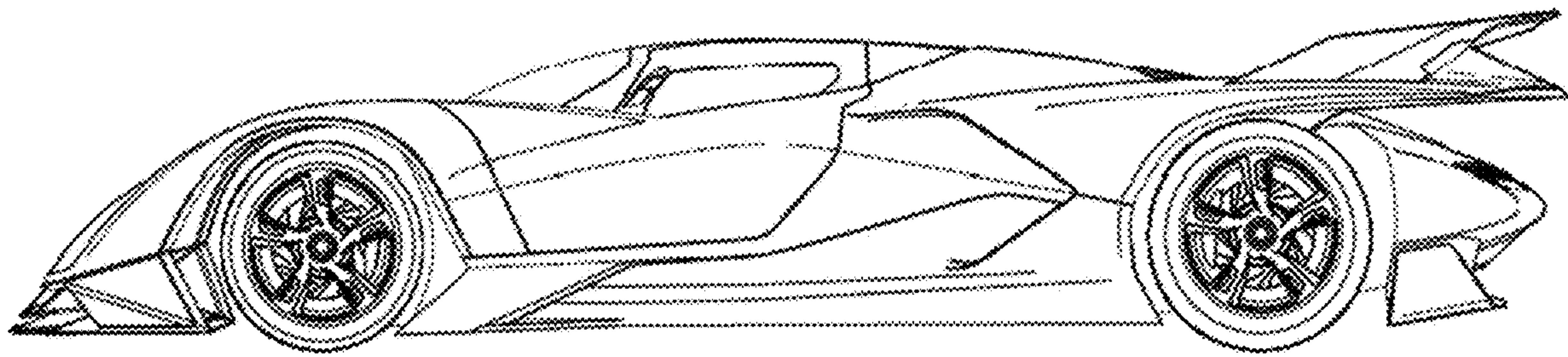

FIG. 4

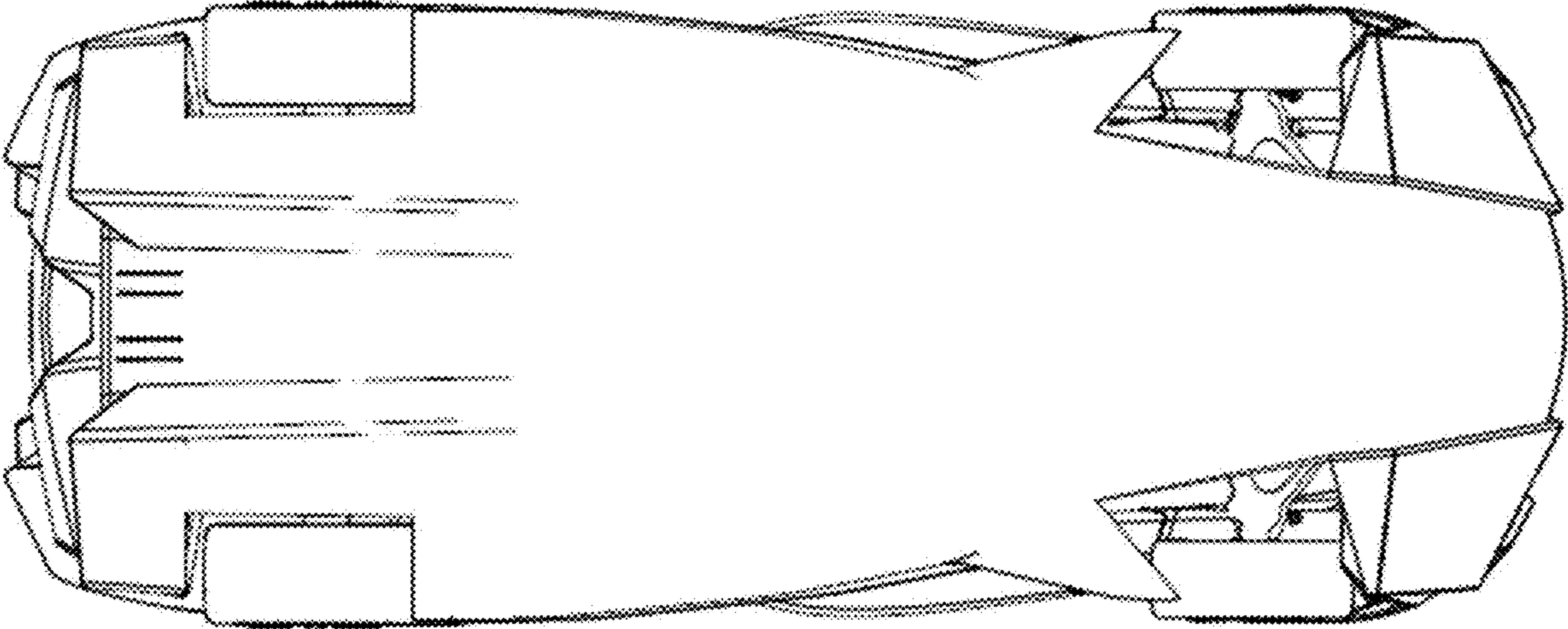

FIG. 5

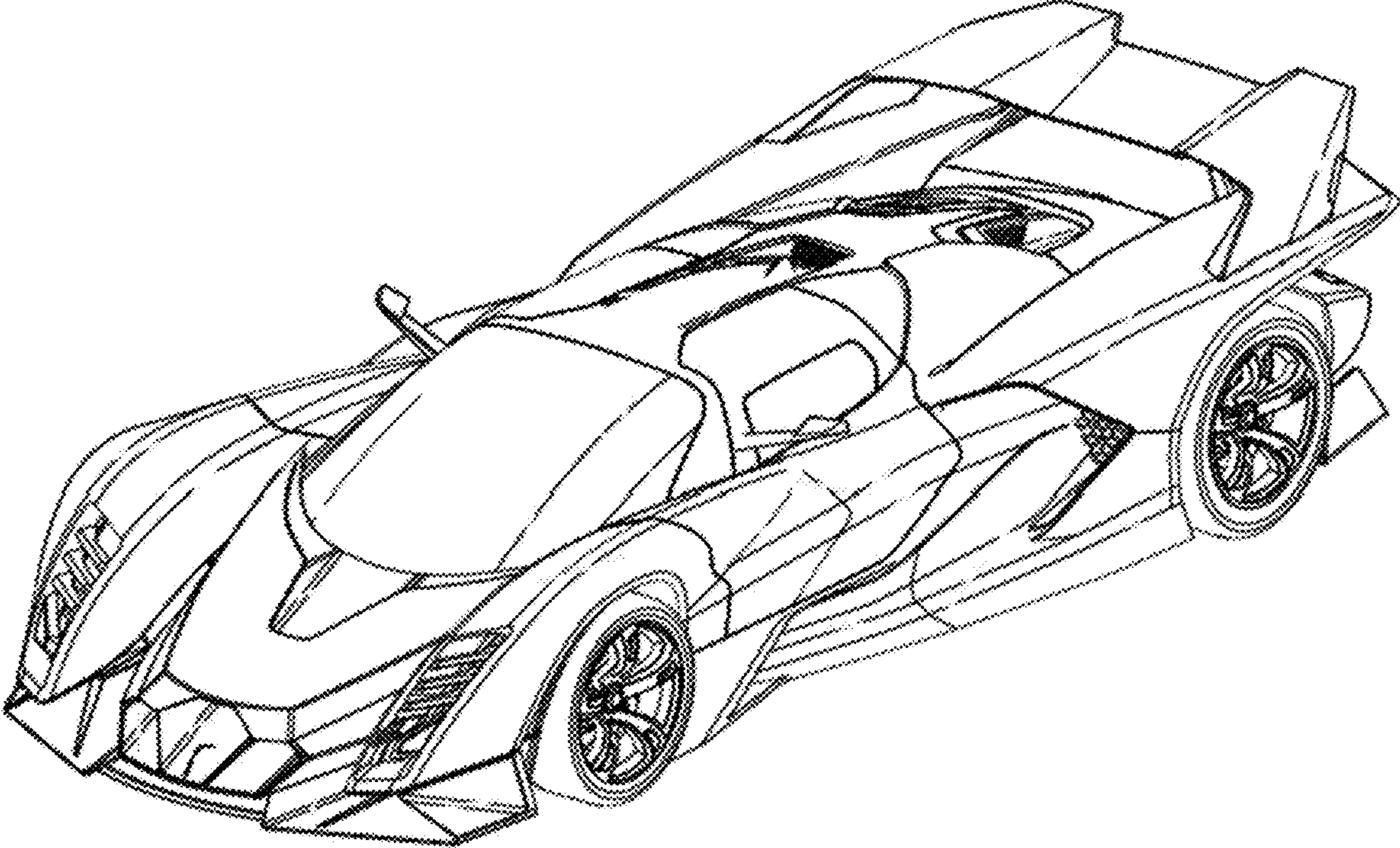

FIG. 6

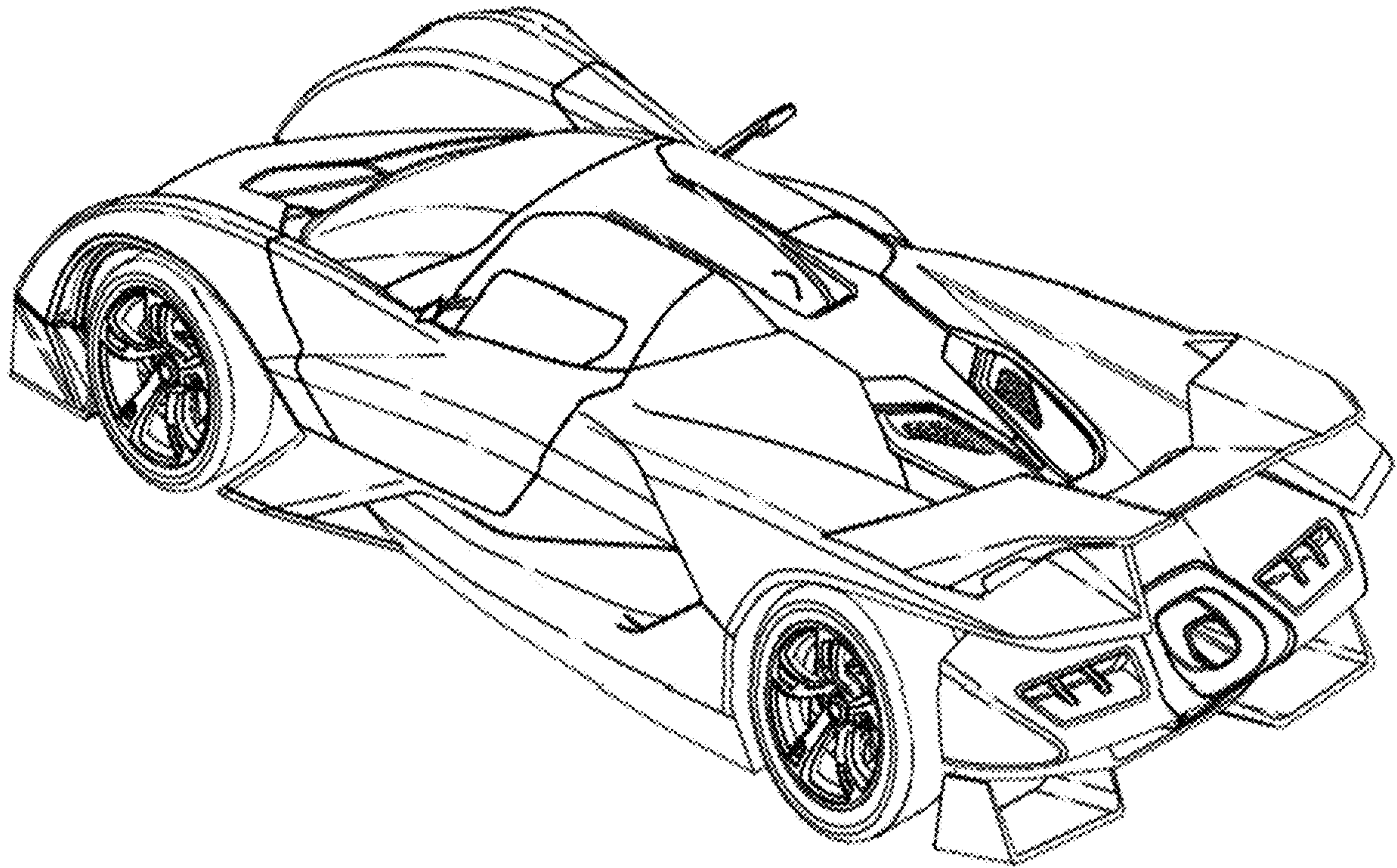

FIG. 7