



US00D964623S

(12) **United States Design Patent** (10) **Patent No.:** **US D964,623 S**  
**Jiang** (45) **Date of Patent:** **\*\* Sep. 20, 2022**

(54) **LAMP**

(71) Applicant: **Shunyuan Jiang**, Sichuan (CN)

(72) Inventor: **Shunyuan Jiang**, Sichuan (CN)

(\*\*) Term: **15 Years**

(21) Appl. No.: **29/739,257**

(22) Filed: **Jun. 24, 2020**

(51) **LOC (13) Cl.** ..... **26-05**

(52) **U.S. Cl.**  
USPC ..... **D26/65**

(58) **Field of Classification Search**

USPC ... D26/1, 24, 35, 44, 60, 61, 63, 65, 66, 72,  
D26/76, 80, 81, 83, 84, 93, 25, 29, 86,  
D26/87; D21/302, 306

CPC .... F21Y 2107/00; F21Y 2105/16; F21V 3/02;  
F21V 21/30; F21V 14/02; F21V 17/164;  
F21V 11/18; F21V 11/183

See application file for complete search history.

(56) **References Cited**

**U.S. PATENT DOCUMENTS**

D212,722 S *	11/1968	Kahn	.....	D10/114.1
5,800,048 A *	9/1998	Gordin	.....	F21V 7/0016
				362/275
D608,488 S *	1/2010	Miranda	.....	D26/87
D753,330 S *	4/2016	Lee	.....	D26/65
D760,426 S *	6/2016	Blum	.....	D26/120
D816,881 S *	5/2018	Qiao	.....	D26/86
D816,882 S *	5/2018	Qiao	.....	D26/86
D833,662 S *	11/2018	Gordin	.....	D26/63
D835,324 S *	12/2018	Haubach	.....	D26/86
D869,730 S *	12/2019	Lin	.....	D26/80
D879,354 S *	3/2020	Lin	.....	D26/87
D898,269 S *	10/2020	Huang	.....	D26/86

(Continued)

**OTHER PUBLICATIONS**

[Hampton Bay 4335442807 4 Brushed Nickel LED Dimmable Fixed Track Lighting Kit], available in Amazon.com, date first

available Jan. 13, 2017 [online], [site visited Dec. 8, 2021], available from internet URL: [https://www.amazon.com/dp/B01N5PBJIR/ref=cm\\_sw\\_em\\_r\\_mt\\_dp\\_R8GS6NC8XHWCW1ZQYQKC2](https://www.amazon.com/dp/B01N5PBJIR/ref=cm_sw_em_r_mt_dp_R8GS6NC8XHWCW1ZQYQKC2) (Year: 2017).\*

(Continued)

*Primary Examiner* — Marissa J Cash  
*Assistant Examiner* — Liv C Anderson

(57) **CLAIM**

The ornamental design for a lamp, as shown and described.

**DESCRIPTION**

FIG. 1 is a front and top perspective view of a lamp, showing my new design;  
 FIG. 2 is a rear and top perspective view thereof;  
 FIG. 3 is a front elevational view thereof;  
 FIG. 4 is a rear elevational view thereof;  
 FIG. 5 is a left side elevational view thereof;  
 FIG. 6 is a right side elevational view thereof;  
 FIG. 7 is a top plan view thereof;  
 FIG. 8 is a bottom plan view thereof;  
 FIG. 9 is a perspective view thereof, showing the lamp in a flipped position;  
 FIG. 10 is an enlarged detail view of area with a indicator "10" in FIG. 1;  
 FIG. 11 is an enlarged detail view of area with a indicator "11" in FIG. 2;  
 FIG. 12 is an enlarged detail view of area with a indicator "12" in FIG. 3; and,  
 FIG. 13 is an enlarged detail view of area with a indicator "13" in FIG. 9.

The broken lines in the figures illustrate portions of the article that form no part of the claimed design. The dot dash dot broken lines in FIGS. 1-3 and 9-13 depict the boundaries of the enlarged detail areas and form no part of the claimed design.

**1 Claim, 13 Drawing Sheets**

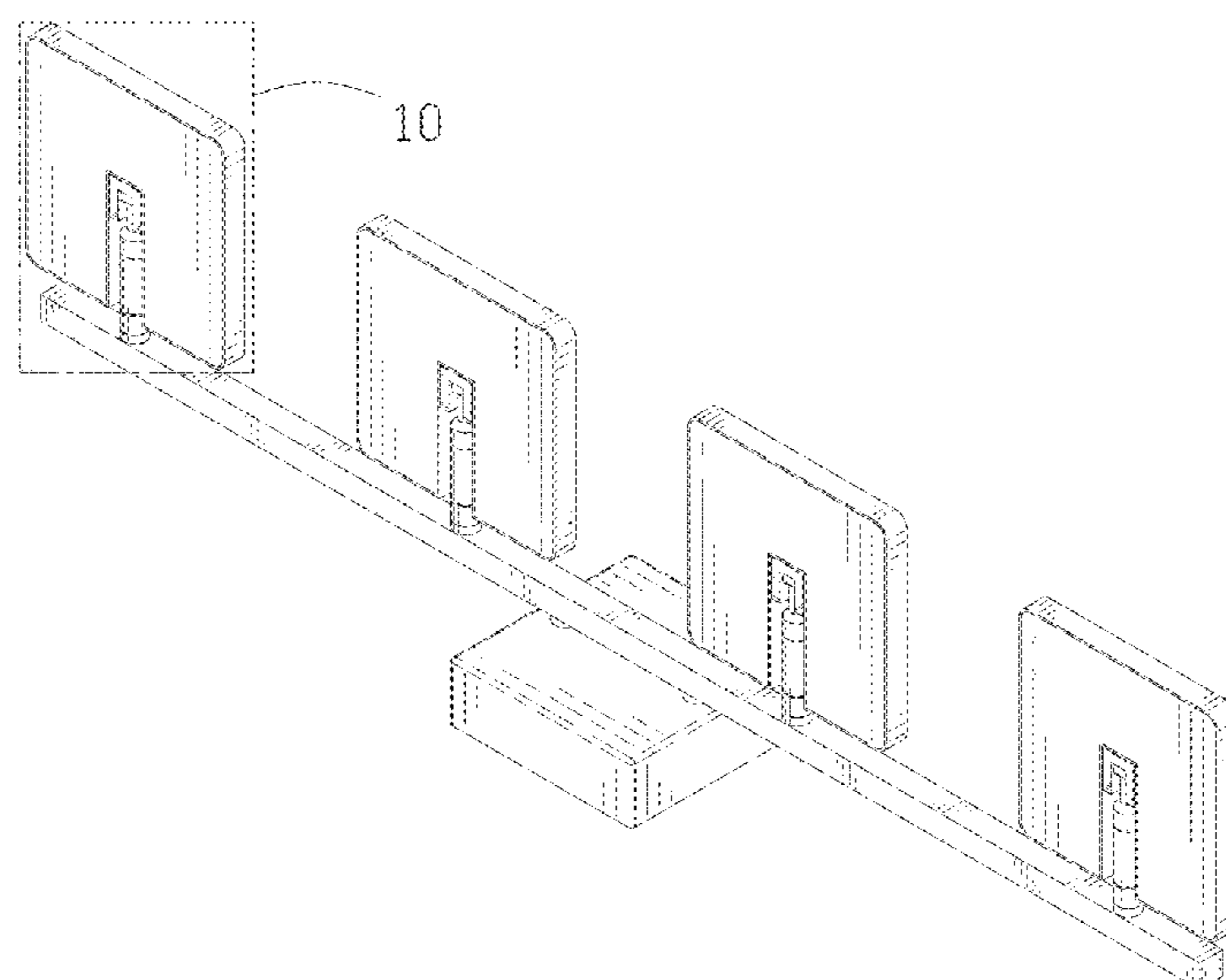

(56)

**References Cited**

U.S. PATENT DOCUMENTS

D908,945 S *	1/2021	Zheng	.....	D26/86
D911,584 S *	2/2021	Zheng	.....	D26/86
D914,266 S *	3/2021	Wang	.....	D26/87
D917,768 S *	4/2021	Chen	.....	D26/87
D925,807 S *	7/2021	Chen	.....	D26/87
D945,047 S *	3/2022	Jiang	.....	D26/86
D945,684 S *	3/2022	Yuan	.....	D26/86
D946,809 S *	3/2022	Mei	.....	D26/86
D950,133 S *	4/2022	Lin	.....	D26/86
D950,829 S *	5/2022	Lin	.....	D26/86
D952,928 S *	5/2022	Wen	.....	D26/86

OTHER PUBLICATIONS

[Arnsberg R32524106 Contemporary Modern LED Chandelier . . . ], available in Amazon.com, date first available Jul. 24, 2017 [online], [site visited Dec. 10, 2021], available from

internet URL: [https://www.amazon.com/dp/B0746MLBY5/ref=cm\\_sw\\_em\\_r\\_mt\\_dp\\_Q583527MGC2QFSYZFZ0C](https://www.amazon.com/dp/B0746MLBY5/ref=cm_sw_em_r_mt_dp_Q583527MGC2QFSYZFZ0C) (Year: 2017).\*

[Ralbay Modern Vanity Lights 4 Lights Modern LED Vanity Lights . . . ], available in Amazon.com, date first available Nov. 30, 2020 [online], [site visited Dec. 10, 2021], available from internet URL: [https://www.amazon.com/dp/B08PBTKCM2/ref=sbl\\_dpx\\_lighting-vanity-lights\\_B07T53FMZM\\_0?th=1](https://www.amazon.com/dp/B08PBTKCM2/ref=sbl_dpx_lighting-vanity-lights_B07T53FMZM_0?th=1) (Year: 2020).\*

[Dainolite Ltd VLD-215-4W-PC Contemporary Modern LED Vanity Fixture . . . ], available from Amazon.com, date first available Oct. 11, 2018 [online], [site visited Dec. 10, 2021], available from internet URL: [https://www.amazon.com/dp/B07L4QVH6Q/ref=sbl\\_dpx\\_lighting-vanity-lights\\_B07T53FMZM\\_0](https://www.amazon.com/dp/B07L4QVH6Q/ref=sbl_dpx_lighting-vanity-lights_B07T53FMZM_0) (Year: 2018).\*

[Fibevon Targets for Nerf Guns . . . ], available in Amazon.com, oldest review date Feb. 10, 2020, [site visited Dec. 14, 2021], available from internet URL: [https://www.amazon.com/Targets-Electronic-Scoring-Digital-Shooting/dp/B07Z8RFVXX/ref=sr\\_1\\_21?keywords=toy%2Btargets&qid=1639508773&sr=8-21&th=1](https://www.amazon.com/Targets-Electronic-Scoring-Digital-Shooting/dp/B07Z8RFVXX/ref=sr_1_21?keywords=toy%2Btargets&qid=1639508773&sr=8-21&th=1) (Year: 2020).\*

\* cited by examiner

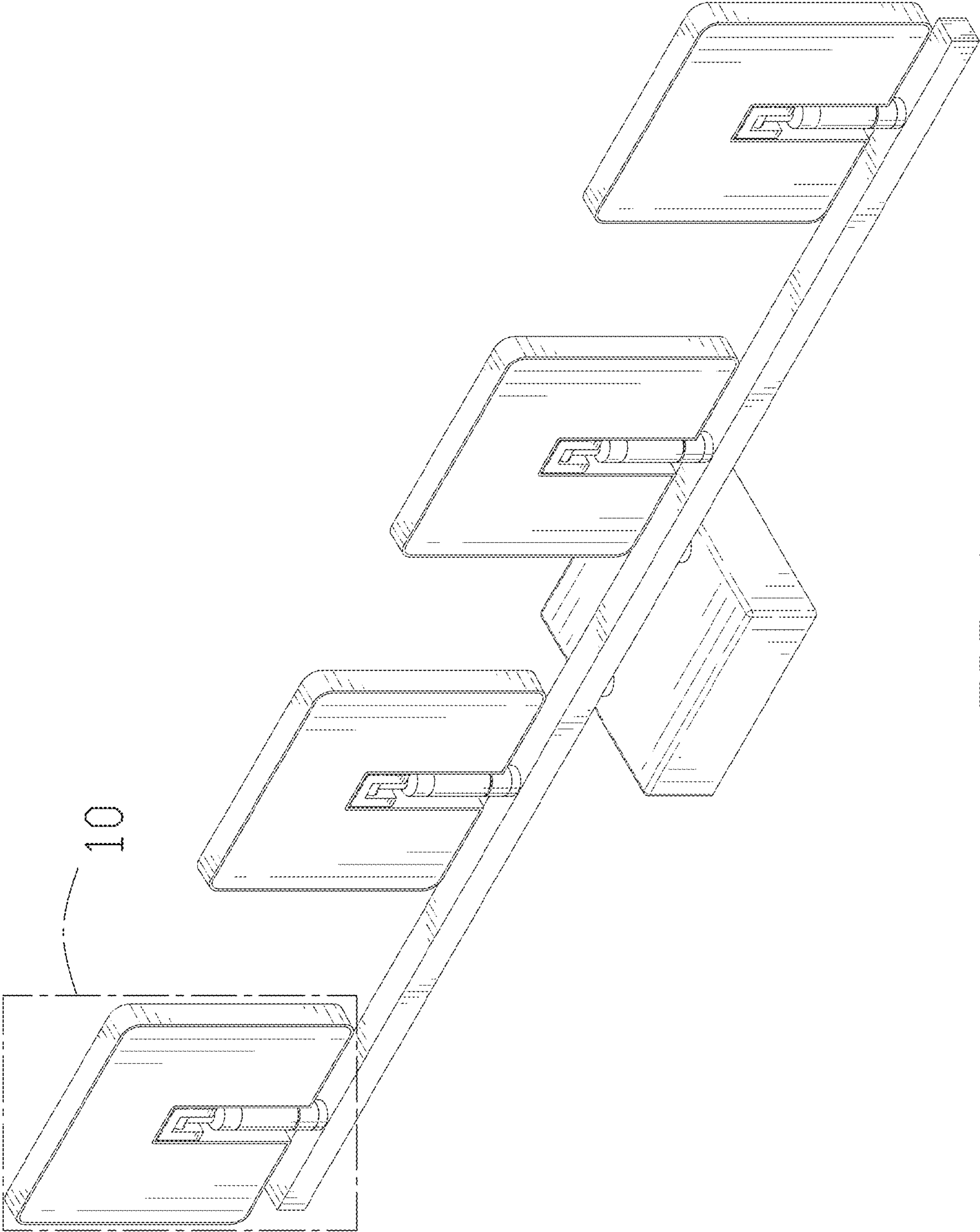

FIG. 1

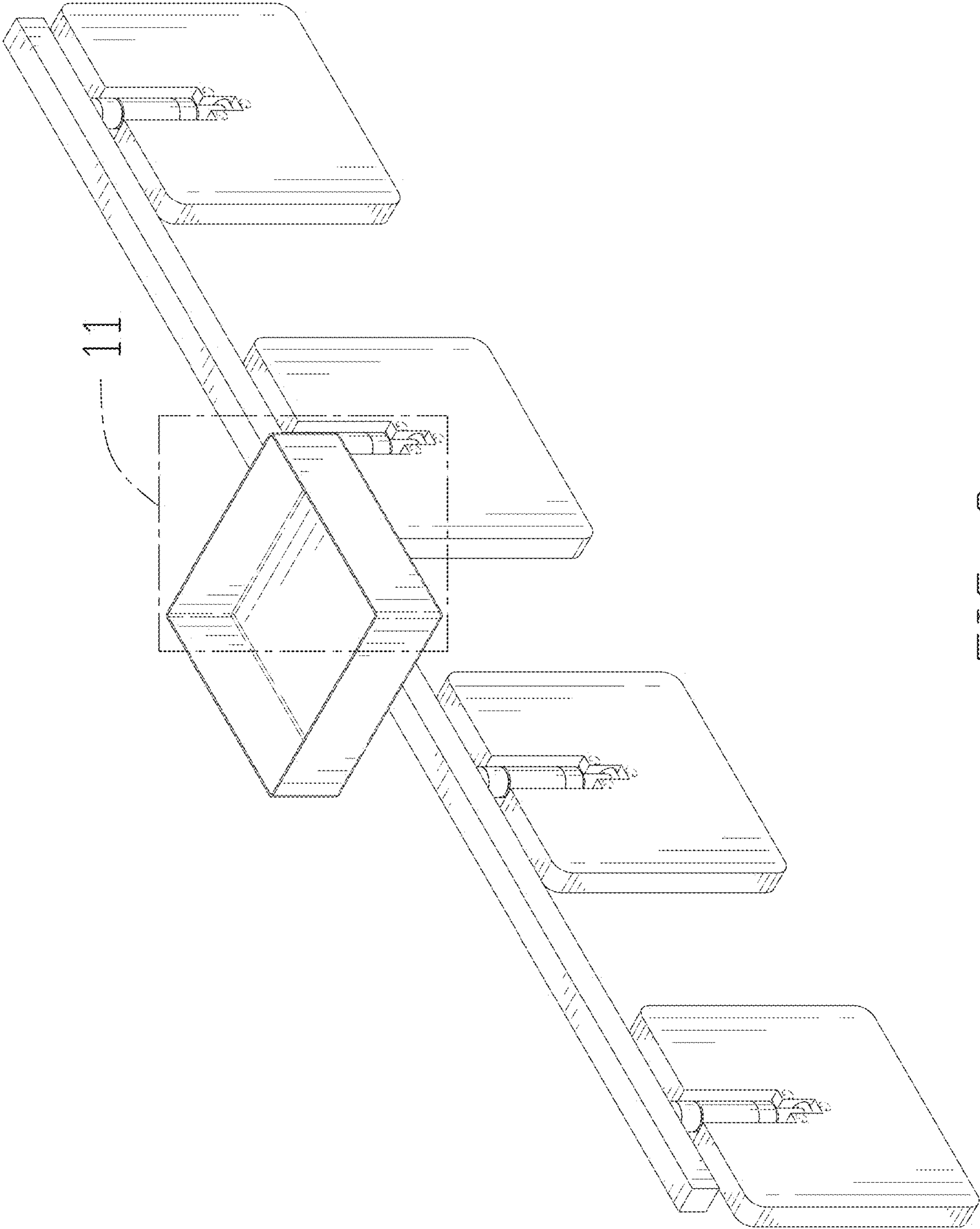

FIG. 2

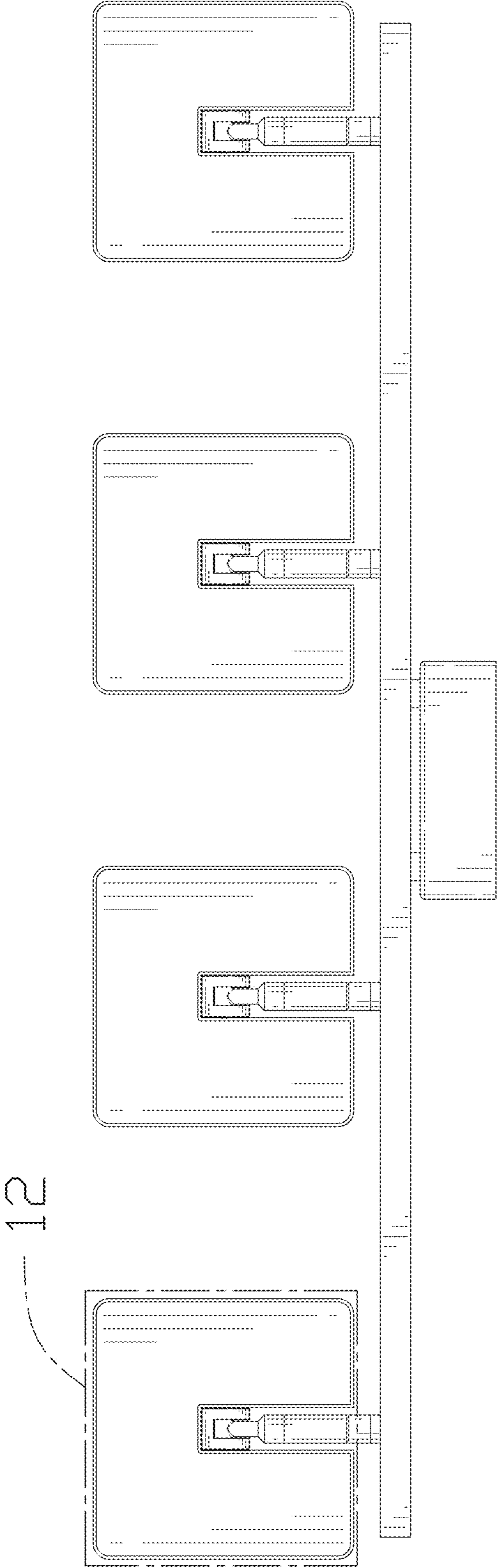

FIG. 3

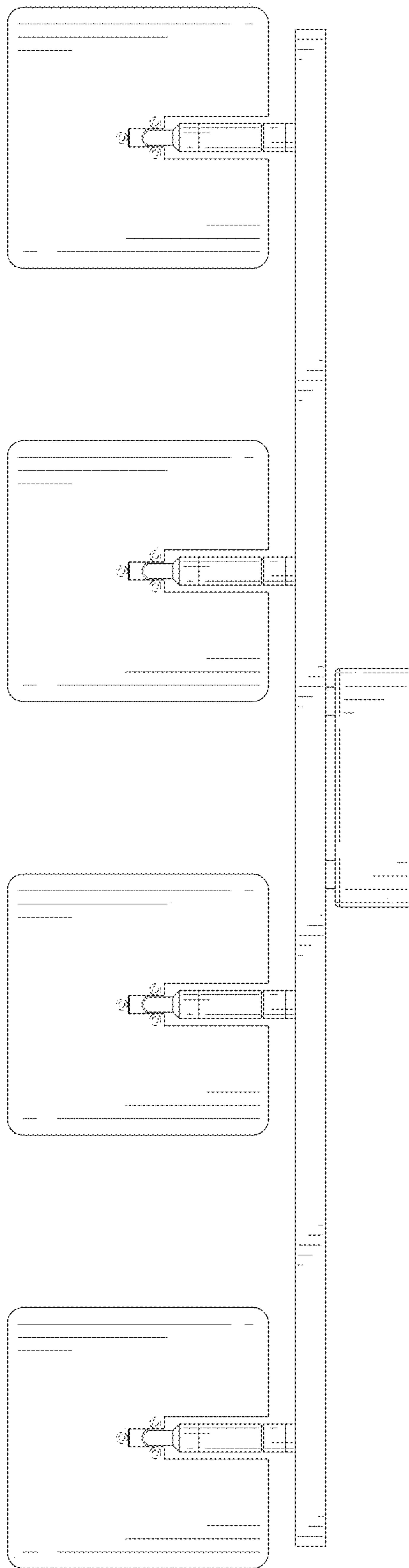

FIG. 4

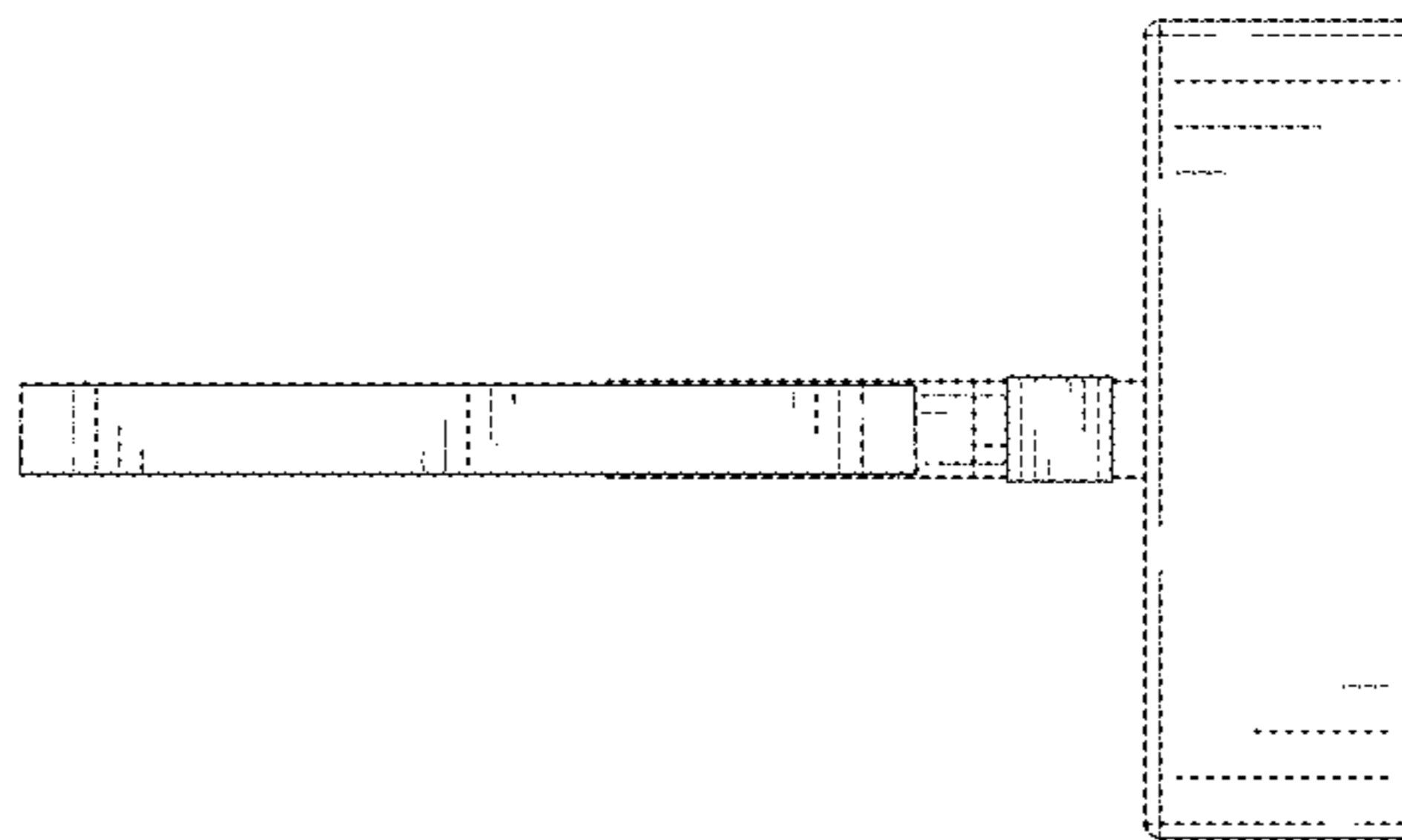

FIG. 5

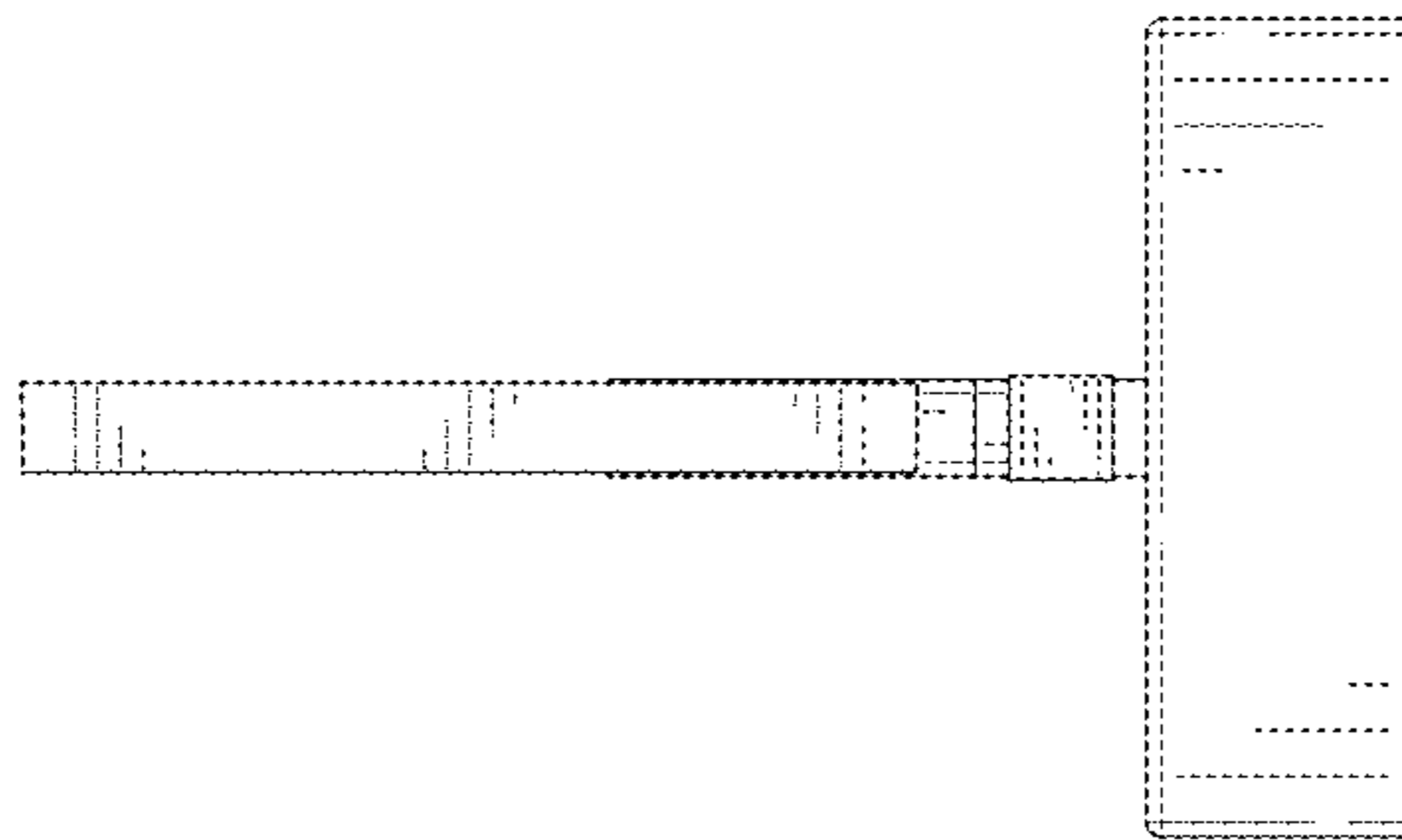

FIG. 6



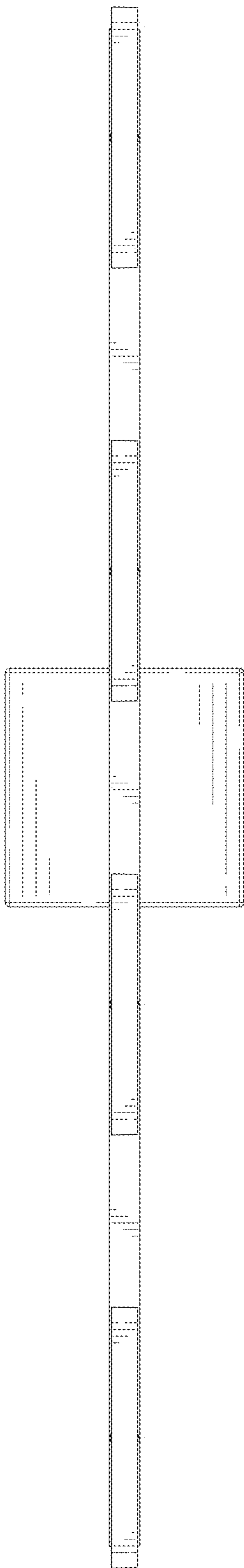

FIG. 7

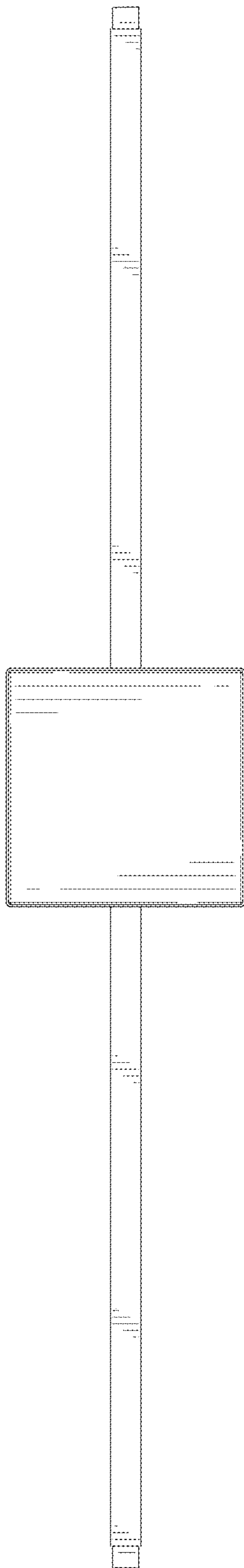

FIG. 8

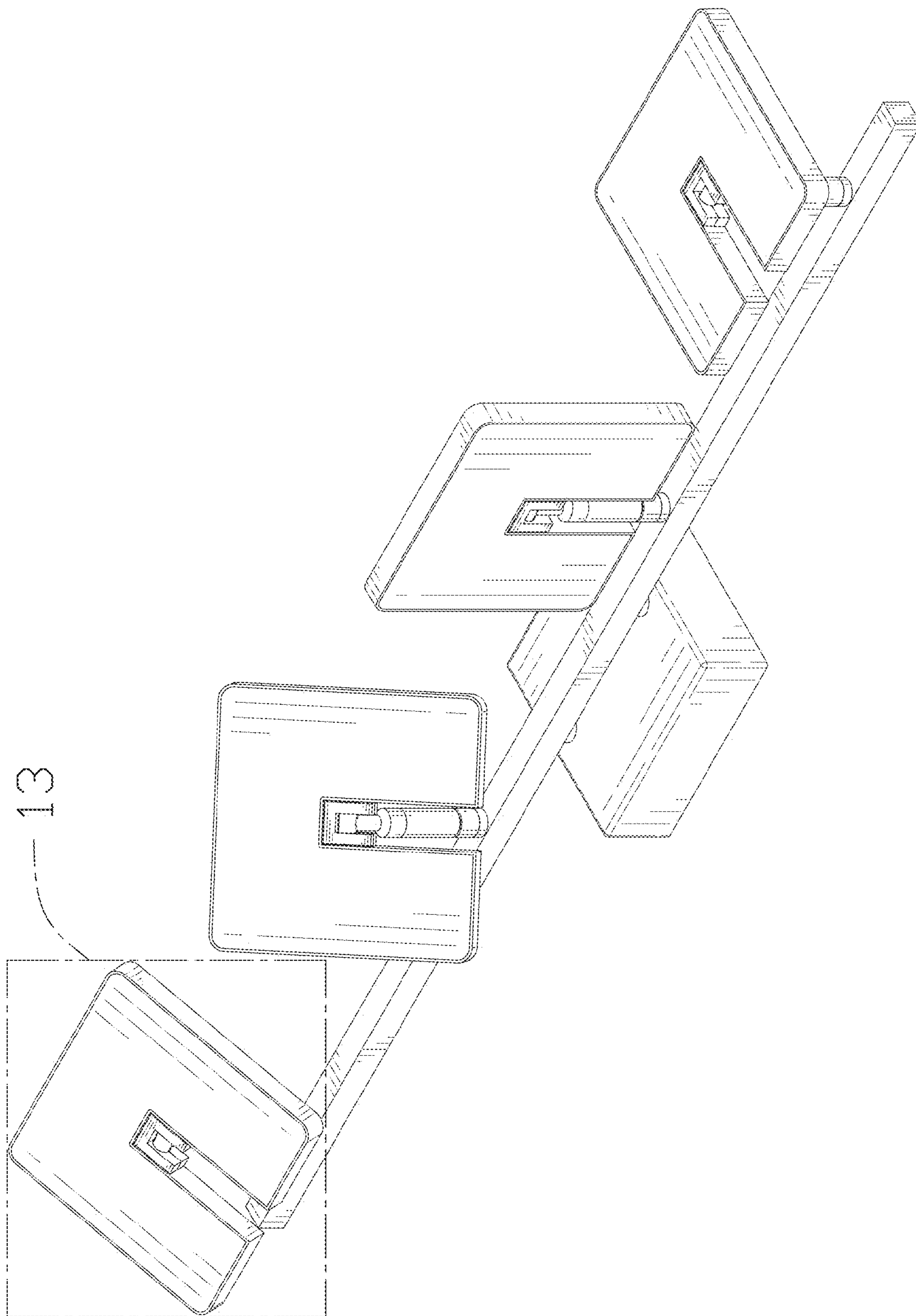

FIG. 9

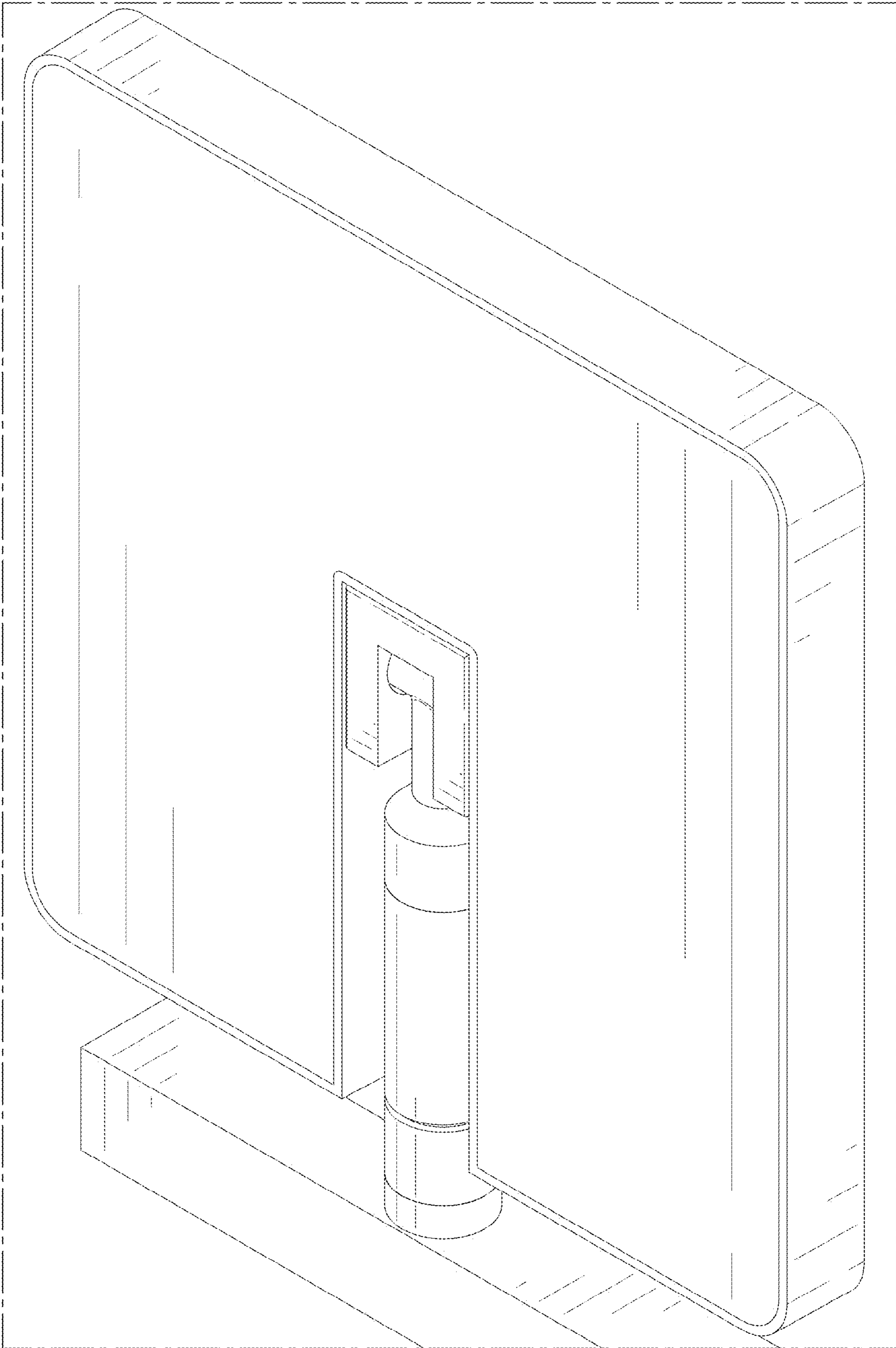

FIG. 10

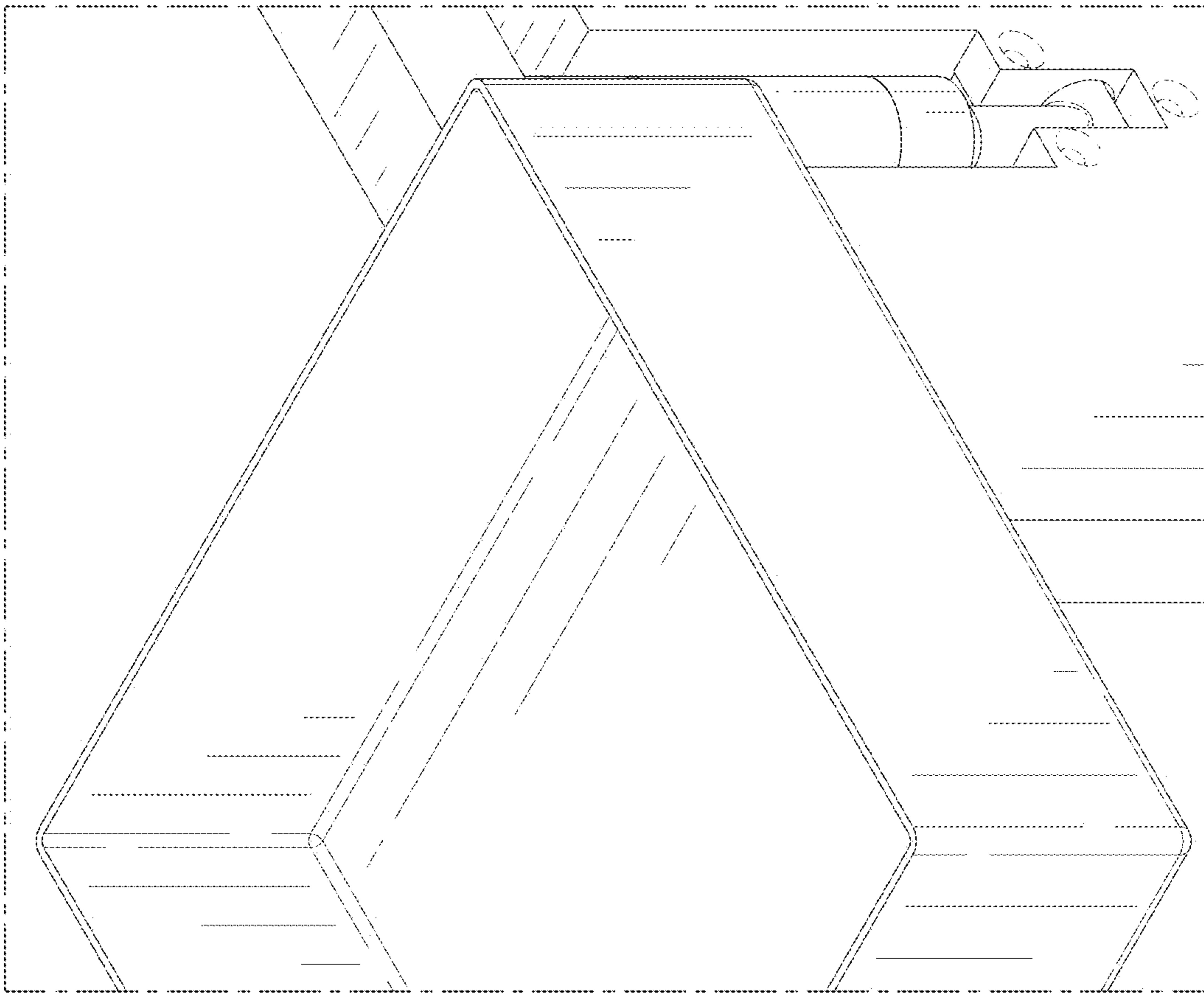

FIG. 11

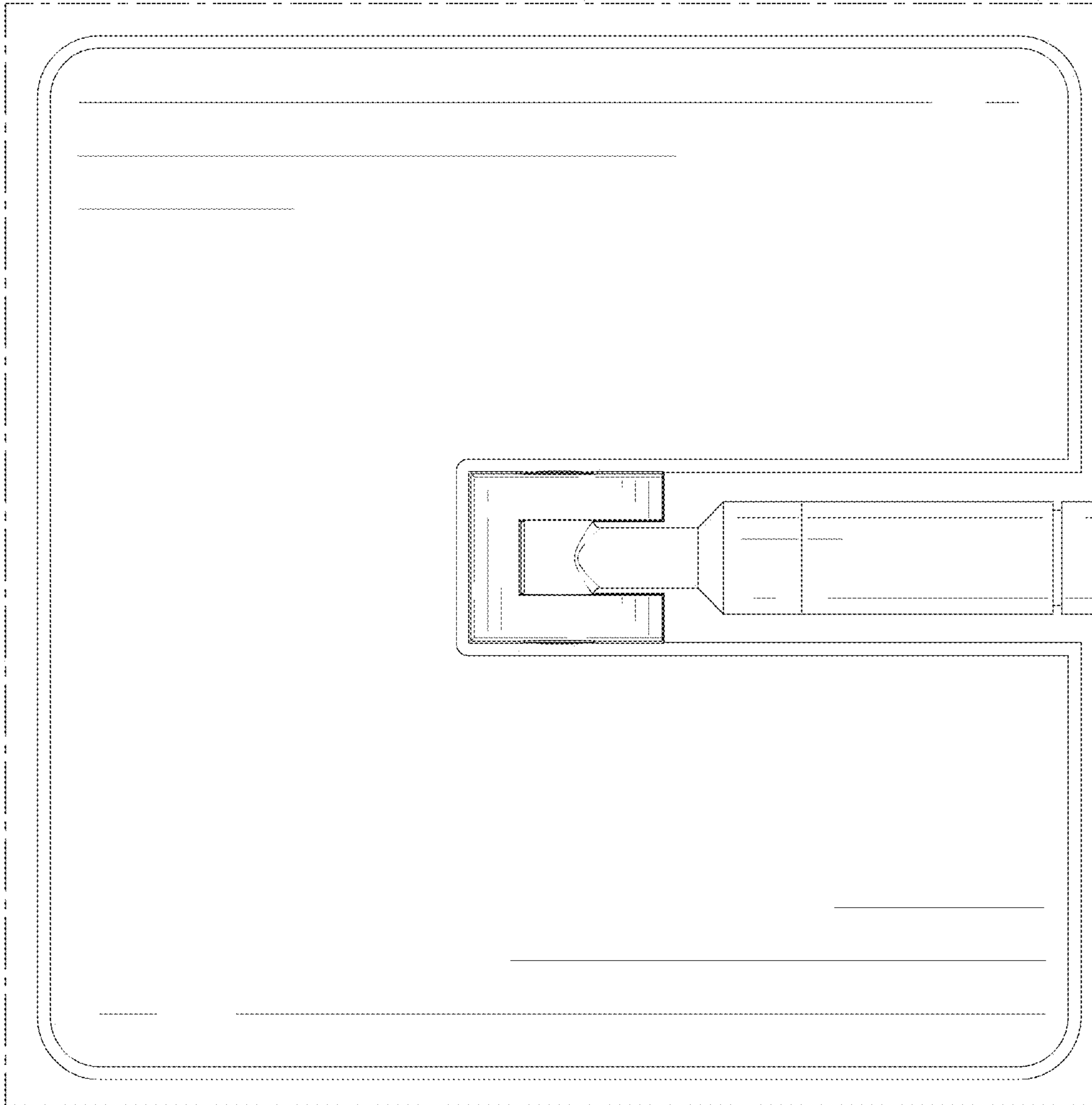

FIG. 12

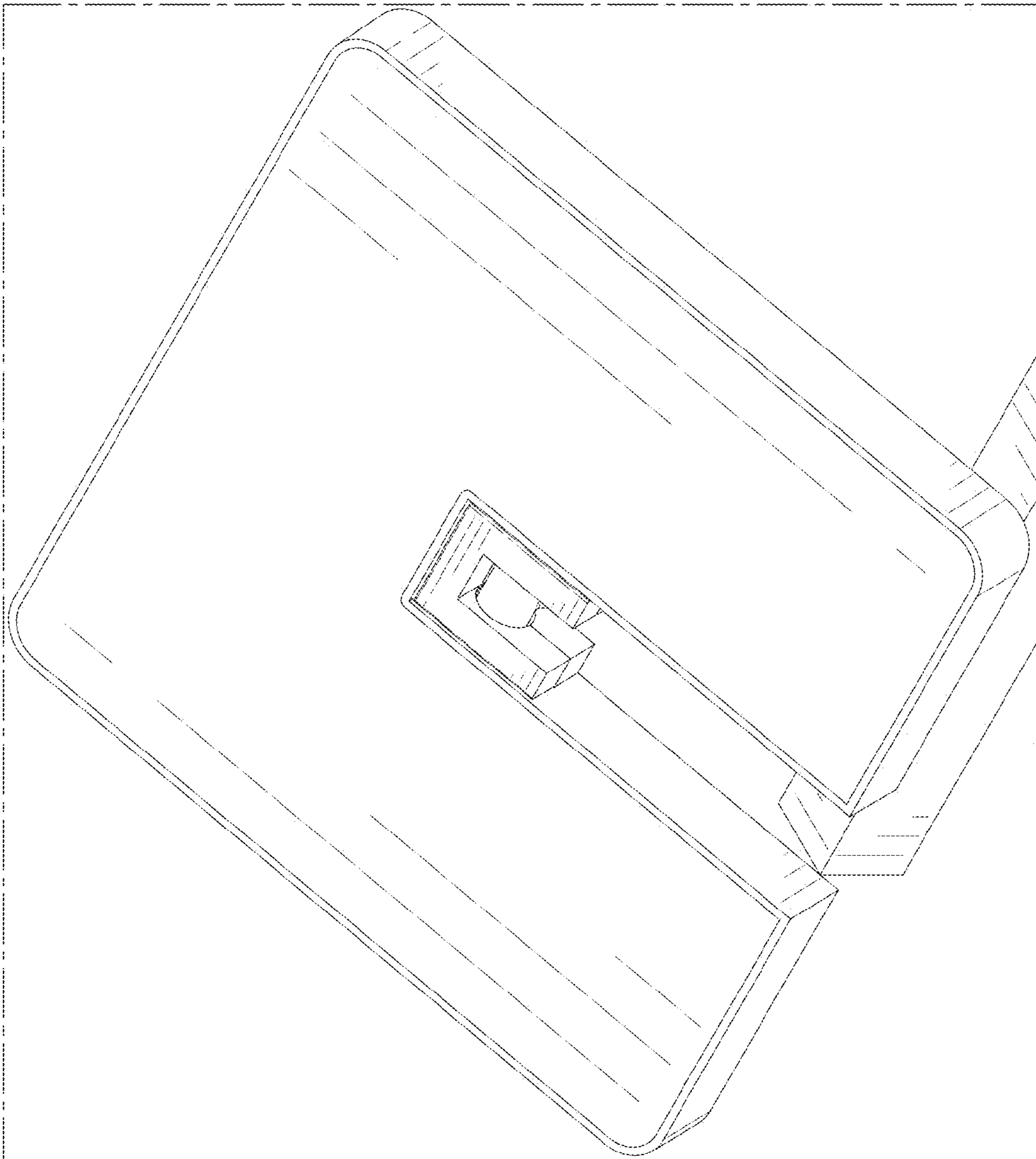

FIG. 13