

US00D964605S

(12) **United States Design Patent**  
**Zhao**

(10) **Patent No.:** **US D964,605 S**  
(45) **Date of Patent:** **\*\* Sep. 20, 2022**

(54) **HEADLIGHT**

(71) Applicant: **Weidi Zhao**, Guangdong (CN)

(72) Inventor: **Weidi Zhao**, Guangdong (CN)

(73) Assignee: **GUANGZHOU CHENGGUANG ELECTRONIC TECHNOLOGY CO., LTD.**, Guangzhou (CN)

(\*\*) Term: **15 Years**

(21) Appl. No.: **29/737,853**

(22) Filed: **Jun. 12, 2020**

(30) **Foreign Application Priority Data**

Mar. 25, 2020 (CN) ..... 202030104753.3

(51) **LOC (13) Cl.** ..... **26-06**

(52) **U.S. Cl.**  
USPC ..... **D26/28**

(58) **Field of Classification Search**

USPC ..... D26/28, 29, 30, 31, 32, 33, 34, 35, 36  
CPC .. F21S 41/00; F21S 41/16; F21S 41/43; F21S 41/141; F21S 41/162; F21S 41/18; F21S 41/20; F21S 41/60; B60Q 1/04; F21W 2103/40; F21W 2103/35; F21W 2107/17; F21W 2107/13

See application file for complete search history.

(56) **References Cited**

**U.S. PATENT DOCUMENTS**

D574,790 S \* 8/2008 Song ..... D13/179  
D587,217 S \* 2/2009 Yun ..... D13/179

D660,256 S \* 5/2012 Yoon ..... D13/179  
D798,475 S \* 9/2017 Georgitsis ..... D26/28  
D855,844 S \* 8/2019 Peng ..... D26/28  
D864,428 S \* 10/2019 Yang ..... D26/24  
D922,620 S \* 6/2021 Yang ..... D26/28

**OTHER PUBLICATIONS**

DOT 110W 5x7 LED Headlights, SHM, Aug. 10, 2020, Published by Amazon, first visited Oct. 14, 2021 via URL: <<https://www.amazon.com/Headlights-Headlamp-Compatible-Cherokee-Replacement/dp/B08FHZ1GKB/>> (Year: 2020).\*

\* cited by examiner

*Primary Examiner* — Leanne Was-Englehart

(74) *Attorney, Agent, or Firm* — Georgi Korobanov

(57) **CLAIM**

The ornamental design for a headlight, as shown and described.

**DESCRIPTION**

FIG. 1 is a perspective view of a headlight showing my new design;  
FIG. 2 is a front elevational view thereof;  
FIG. 3 is a top plan view thereof;  
FIG. 4 is a left side elevational view thereof;  
FIG. 5 is a rear elevational view thereof;  
FIG. 6 is a right side view thereof; and,  
FIG. 7 is a bottom plan view thereof.  
The broken lines in the drawings depict portions of the headlight that form no part of the claimed design.

**1 Claim, 7 Drawing Sheets**

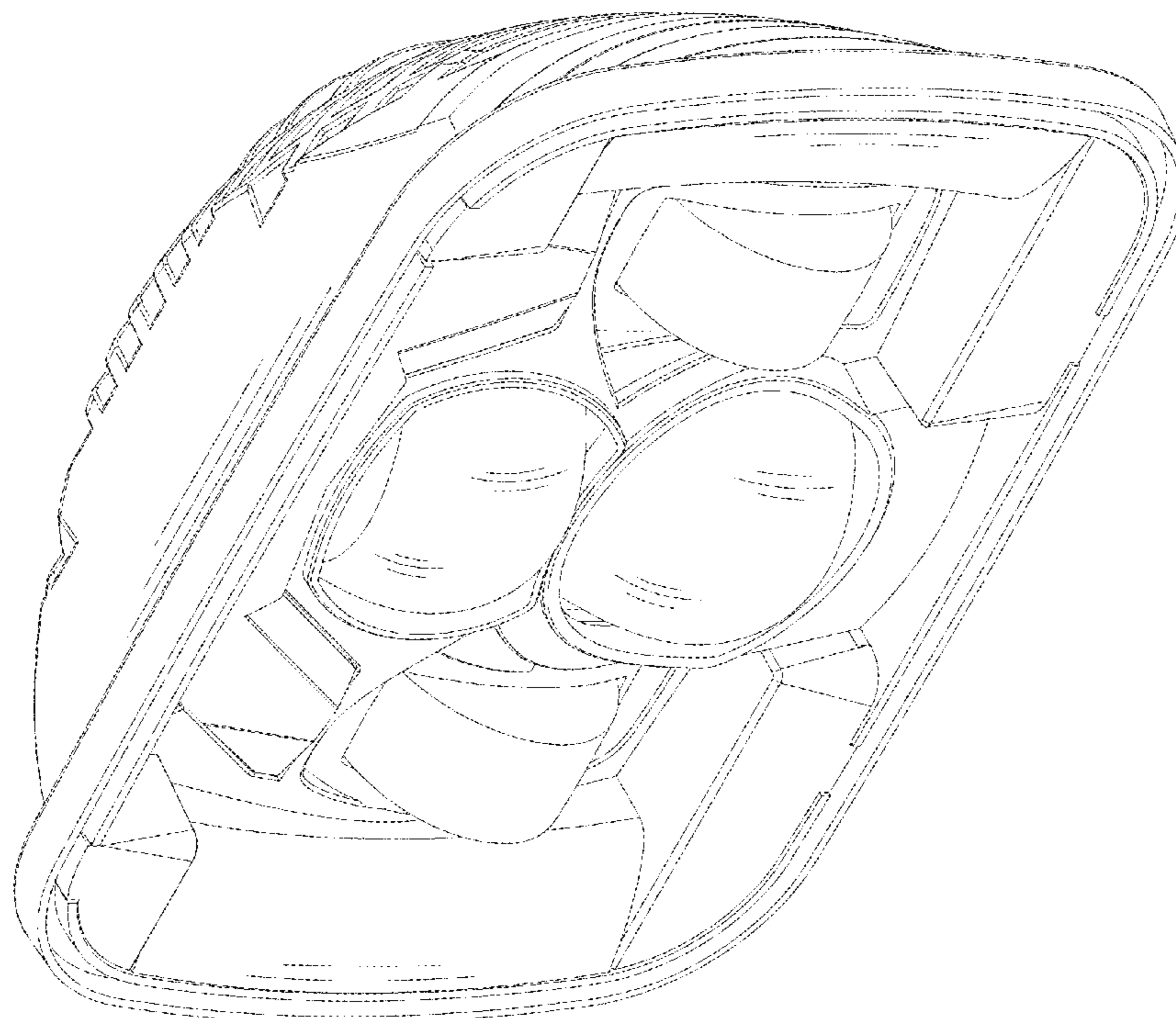



FIG. 1

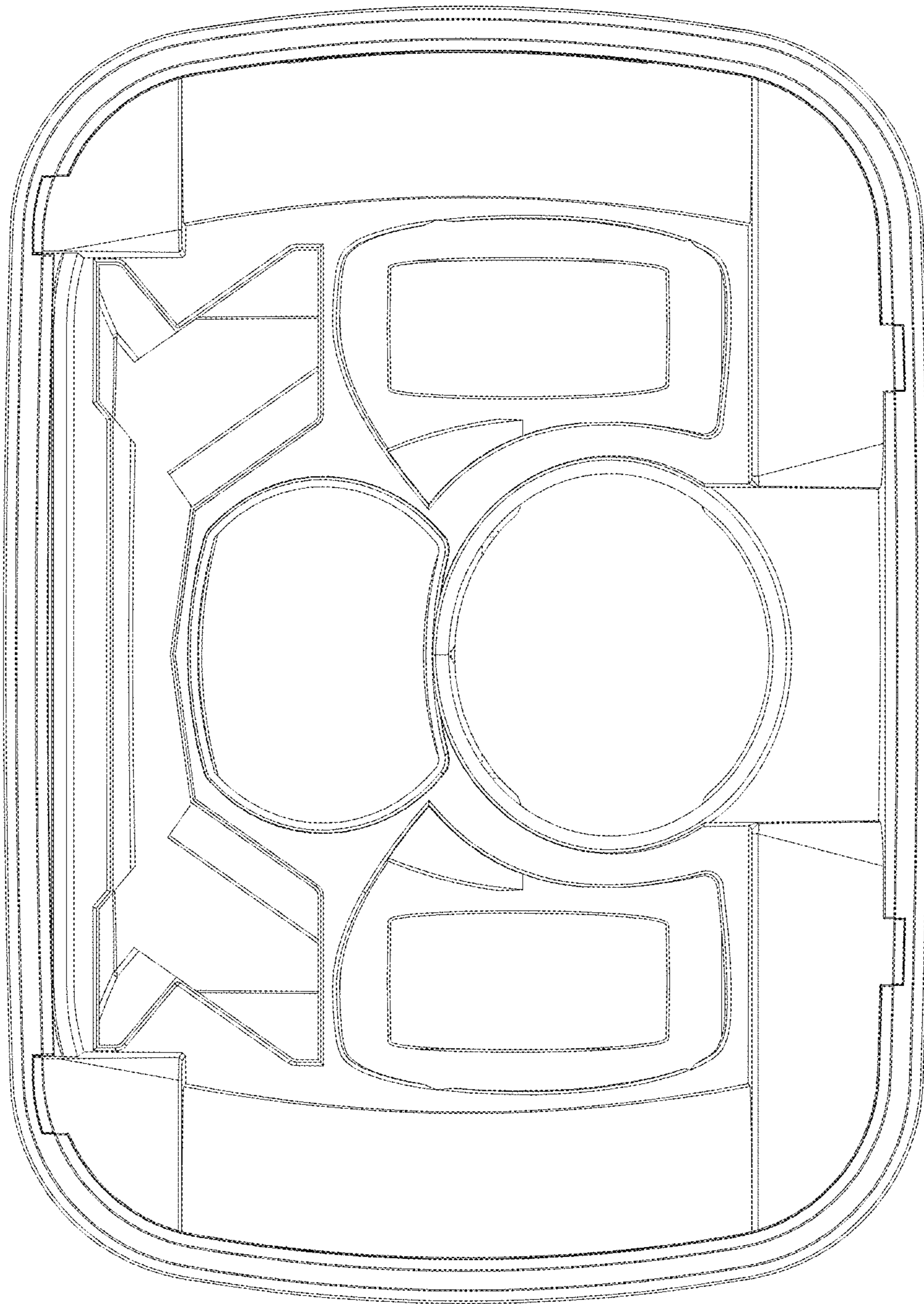

FIG. 2

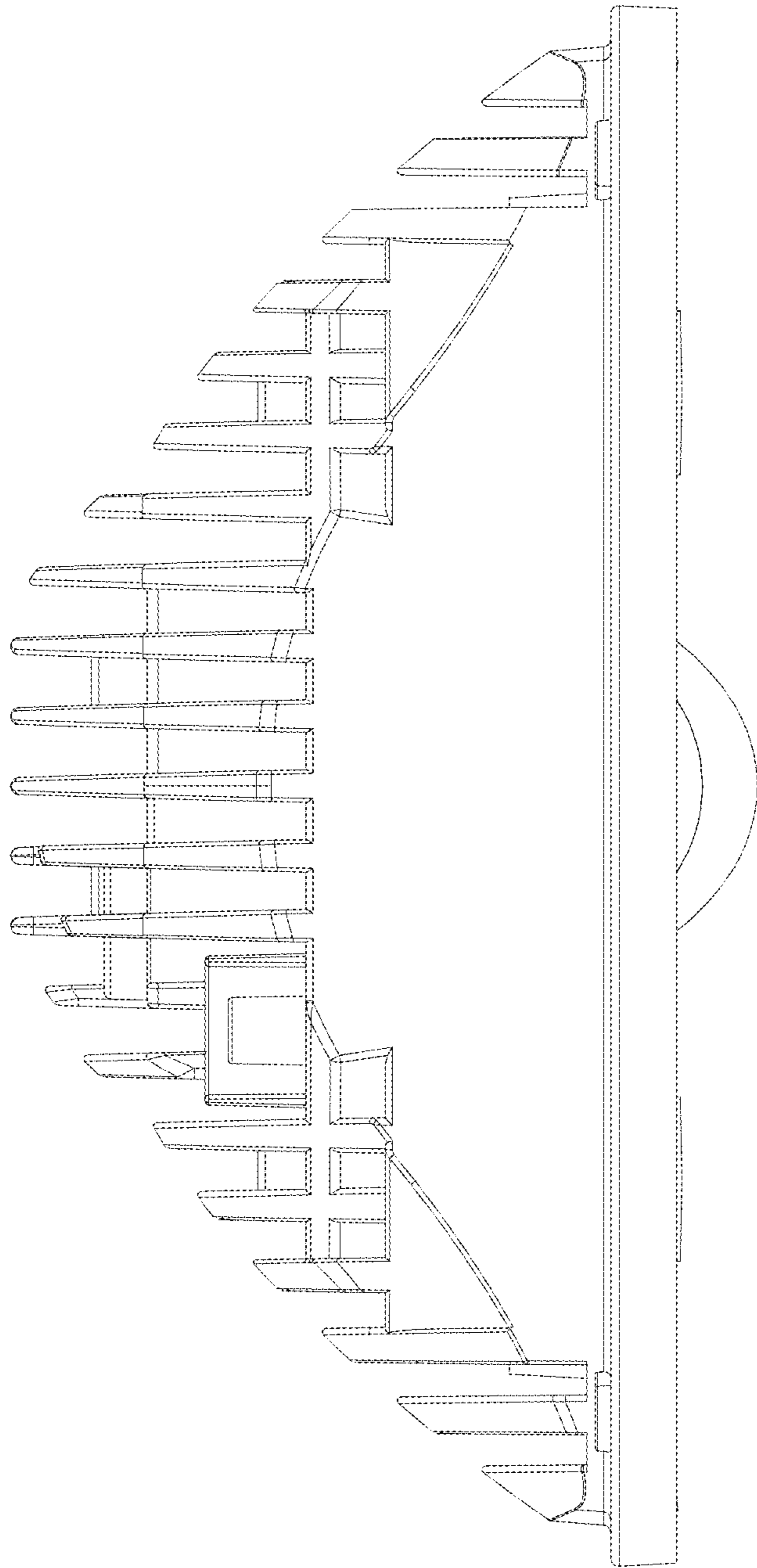

FIG. 3

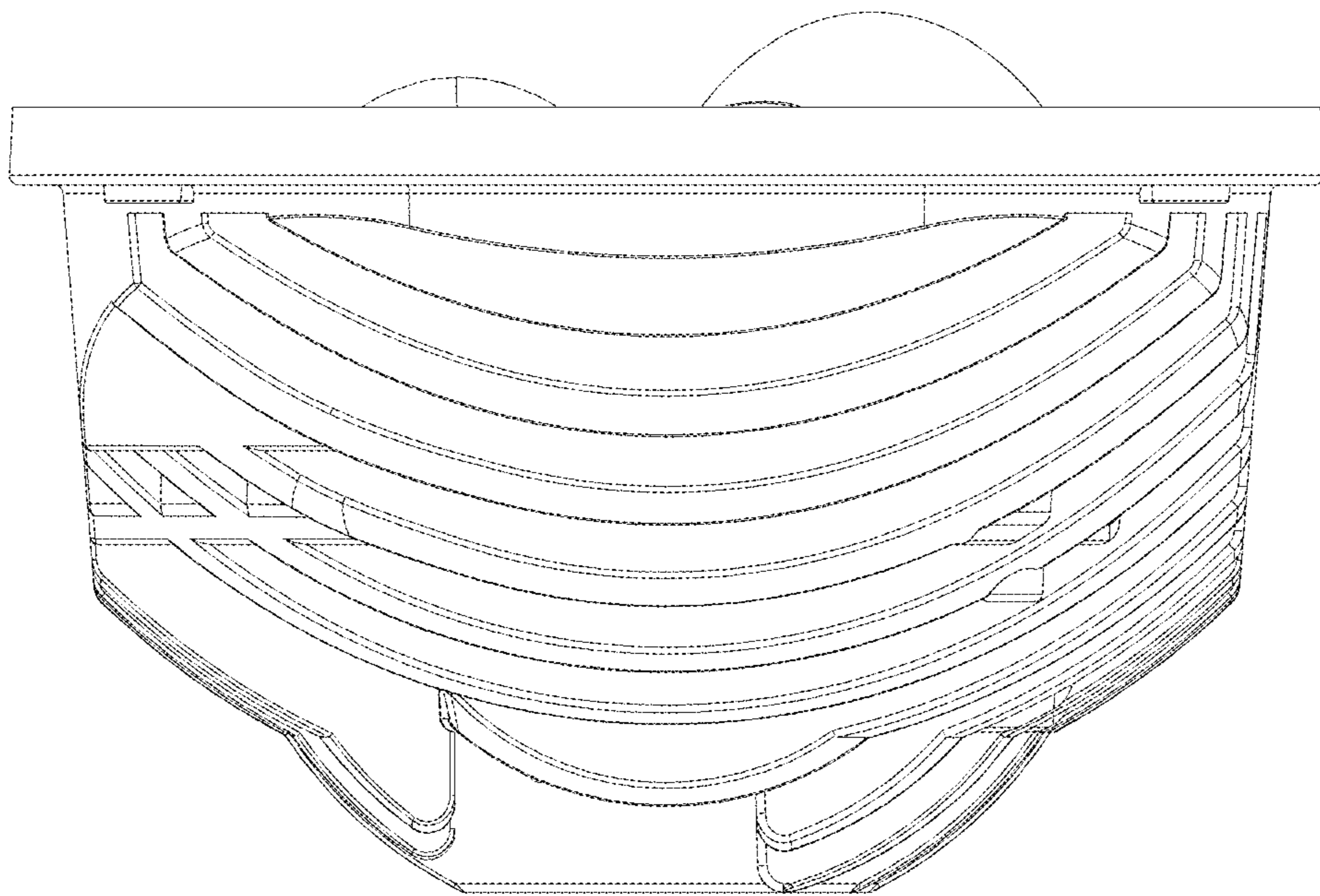

FIG. 4

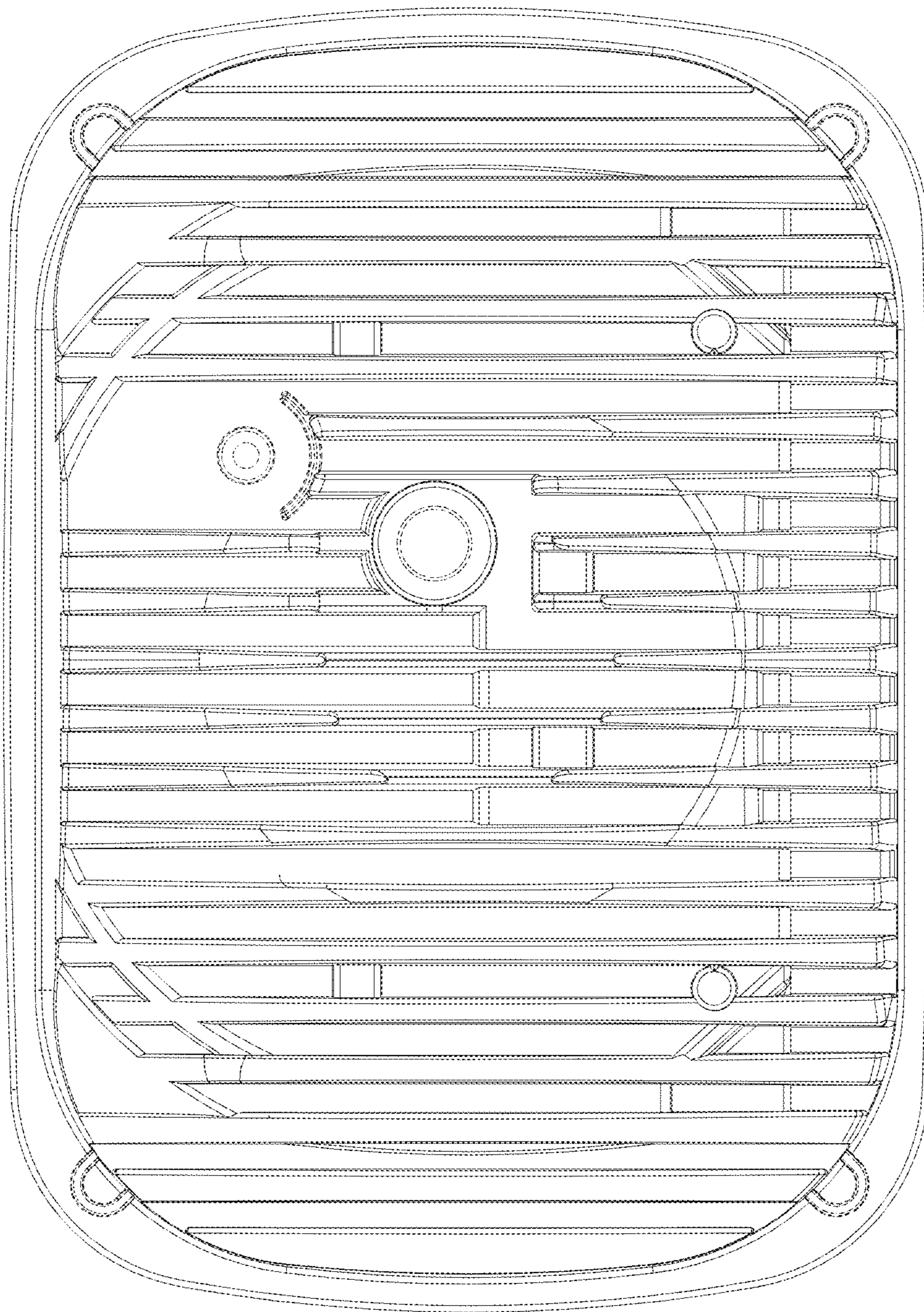

FIG. 5

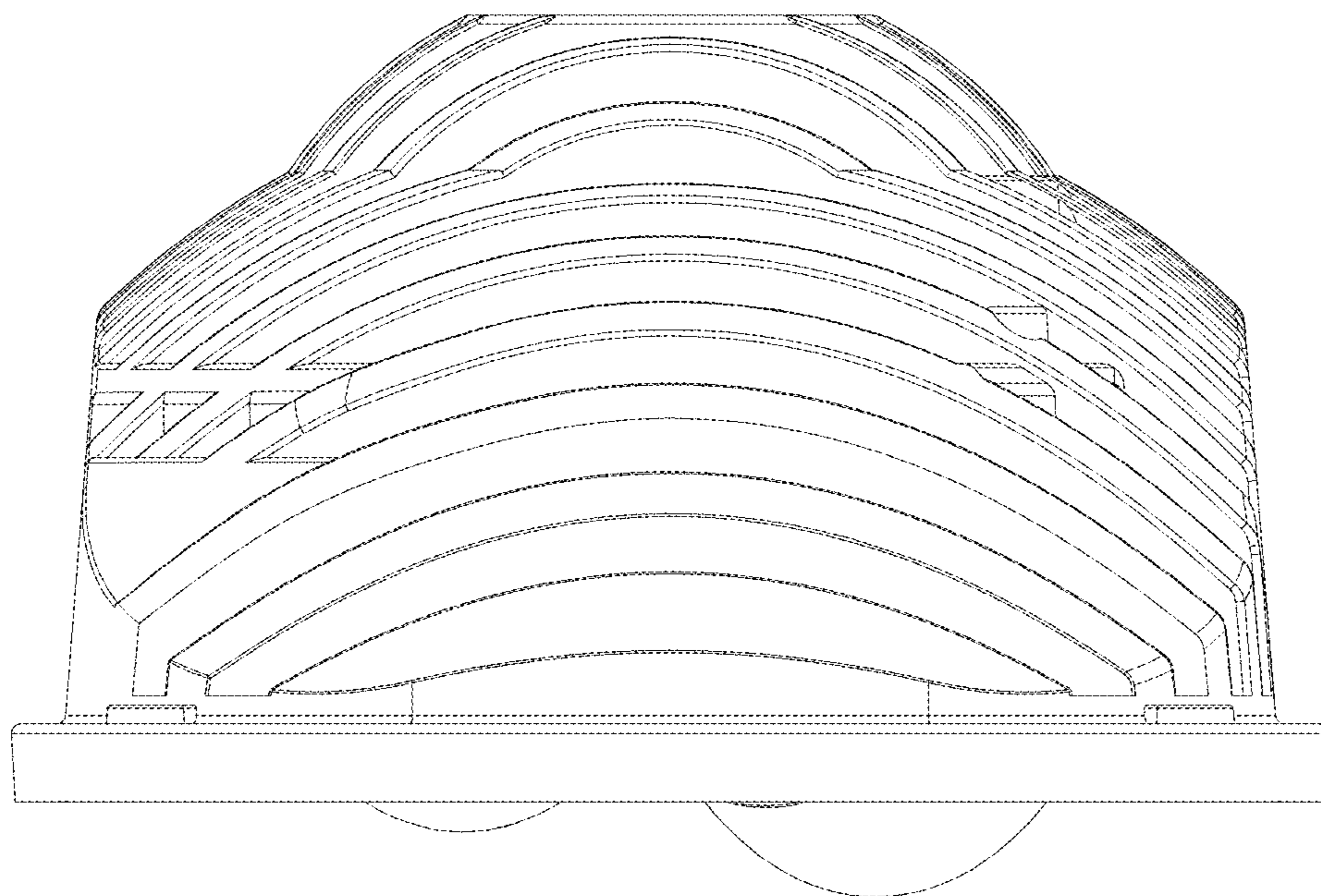

FIG. 6

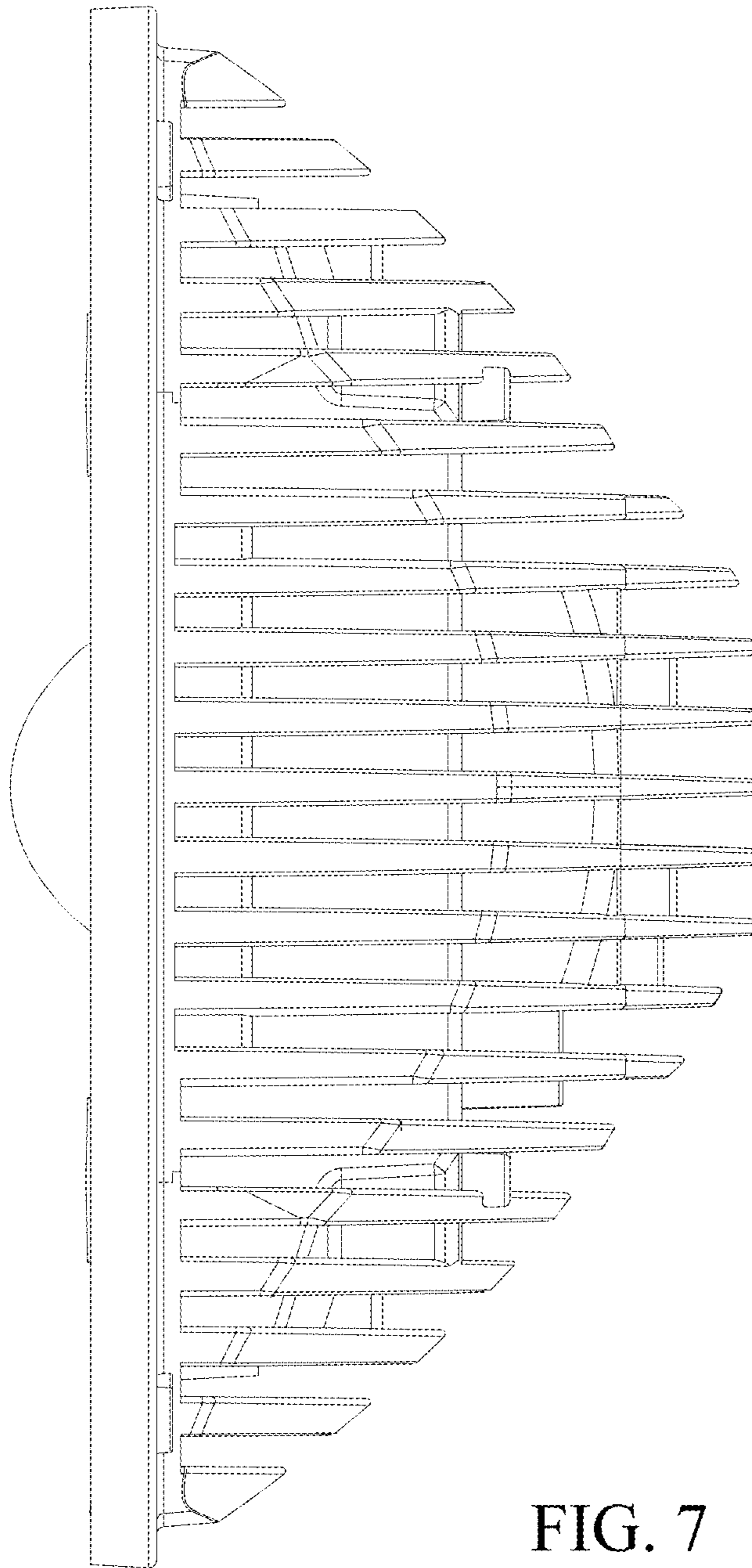

FIG. 7