



US00D964582S

(12) **United States Design Patent** (10) **Patent No.:** **US D964,582 S**
Chengen (45) **Date of Patent:** **** Sep. 20, 2022**

(54) **FACIAL SCRUBBER**
(71) Applicant: **Fourstar Group Inc.**, Taipei (TW)
(72) Inventor: **Zhang Chengen**, Guangzhou (CN)
(73) Assignee: **Fourstar Group Inc.**, Taipei (TW)
(**) Term: **15 Years**
(21) Appl. No.: **29/761,252**
(22) Filed: **Dec. 8, 2020**
(51) **LOC (13) Cl.** **28-03**
(52) **U.S. Cl.**
USPC **D24/214**
(58) **Field of Classification Search**
USPC D24/133, 188, 200, 211, 212, 213, 214,
D24/215; D28/63; D30/160; D4/130,
D4/127, 128
CPC A46B 15/0075; A46B 2200/1006; A46B
2200/1053; A46B 3/00
See application file for complete search history.

D891,113 S * 7/2020 Yoon D4/100
D919,300 S * 5/2021 Li D4/100
D927,066 S * 8/2021 Yue D28/63
D933,367 S * 10/2021 Lee D4/134
D940,469 S * 1/2022 Sommer D4/134
D953,042 S * 5/2022 Kan D4/128

OTHER PUBLICATIONS

Amazon, "Vtrem Facial Cleansing Brush", Date First Available Jul. 25, 2019. https://www.amazon.com/Vtrem-Cleansing-Silicone-Handheld-Exfoliating/dp/B07VRQBHKL/ref=cm_cr_ar_p_d_product_top?ie=UTF8. Shown on p. 1. (Year: 2019).*
Lurellacosmetics, "Facial Exfoliator", Review Date Jun. 18, 2021. https://lurellacosmetics.com/products/sponge-cleaner?_pos=1&_sid=852f25b17&_ss=r&variant=37392471654575#shopify-section-gl-product-page-reviews. Shown on p. 1. (Year: 2021).*

* cited by examiner

Primary Examiner — Michael A Maharajh
(74) *Attorney, Agent, or Firm* — Salter & Michaelson

(57) **CLAIM**

The ornamental design for a facial scrubber, as shown and described.

DESCRIPTION

FIG. 1 is a perspective view of a facial scrubber;
FIG. 2 is a front elevational view thereof;
FIG. 3 is a rear elevational view thereof;
FIG. 4 is a right side elevational view thereof;
FIG. 5 is a left side elevational view thereof;
FIG. 6 is a top plan view thereof; and,
FIG. 7 is a bottom plan view thereof.
The broken lines shown in the drawings are for the purpose of illustrating portions of the facial scrubber, which form no part of the claimed design.

1 Claim, 7 Drawing Sheets

(56) **References Cited**

U.S. PATENT DOCUMENTS

D739,145 S * 9/2015 von Berg D4/127
D764,172 S * 8/2016 Pan D4/100
D795,593 S * 8/2017 Huang D4/127
D804,189 S * 12/2017 von Berg D4/100
D819,338 S * 6/2018 Xiong D4/102
D819,976 S * 6/2018 Albers D4/114
D848,011 S * 5/2019 Champeval D24/215
D849,263 S * 5/2019 Soutelo Gomes D24/215
D864,577 S * 10/2019 Keast D28/63
D876,842 S * 3/2020 Tschopp D4/127
D887,149 S * 6/2020 Yang D4/127
D889,850 S * 7/2020 Rybacek D4/133

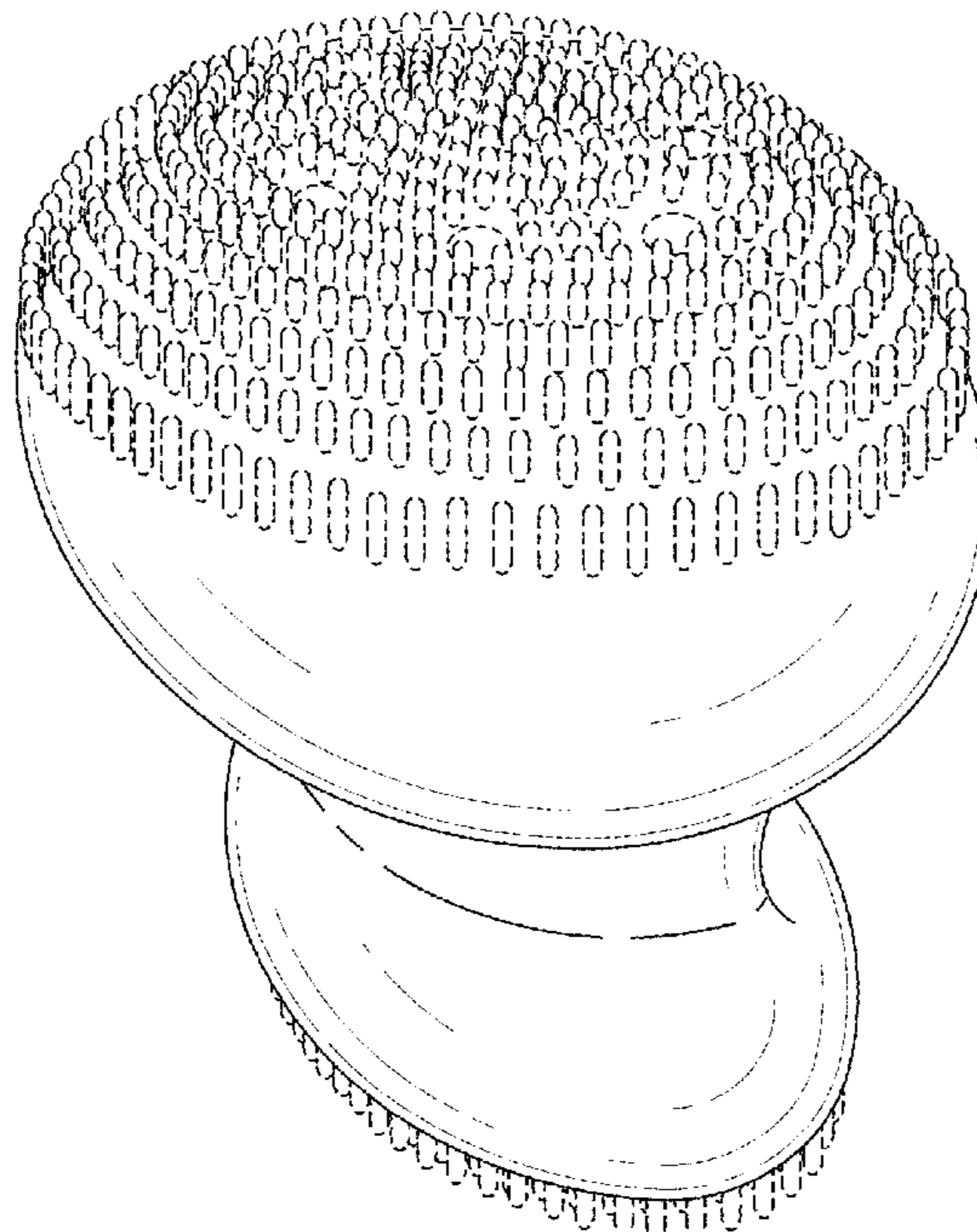

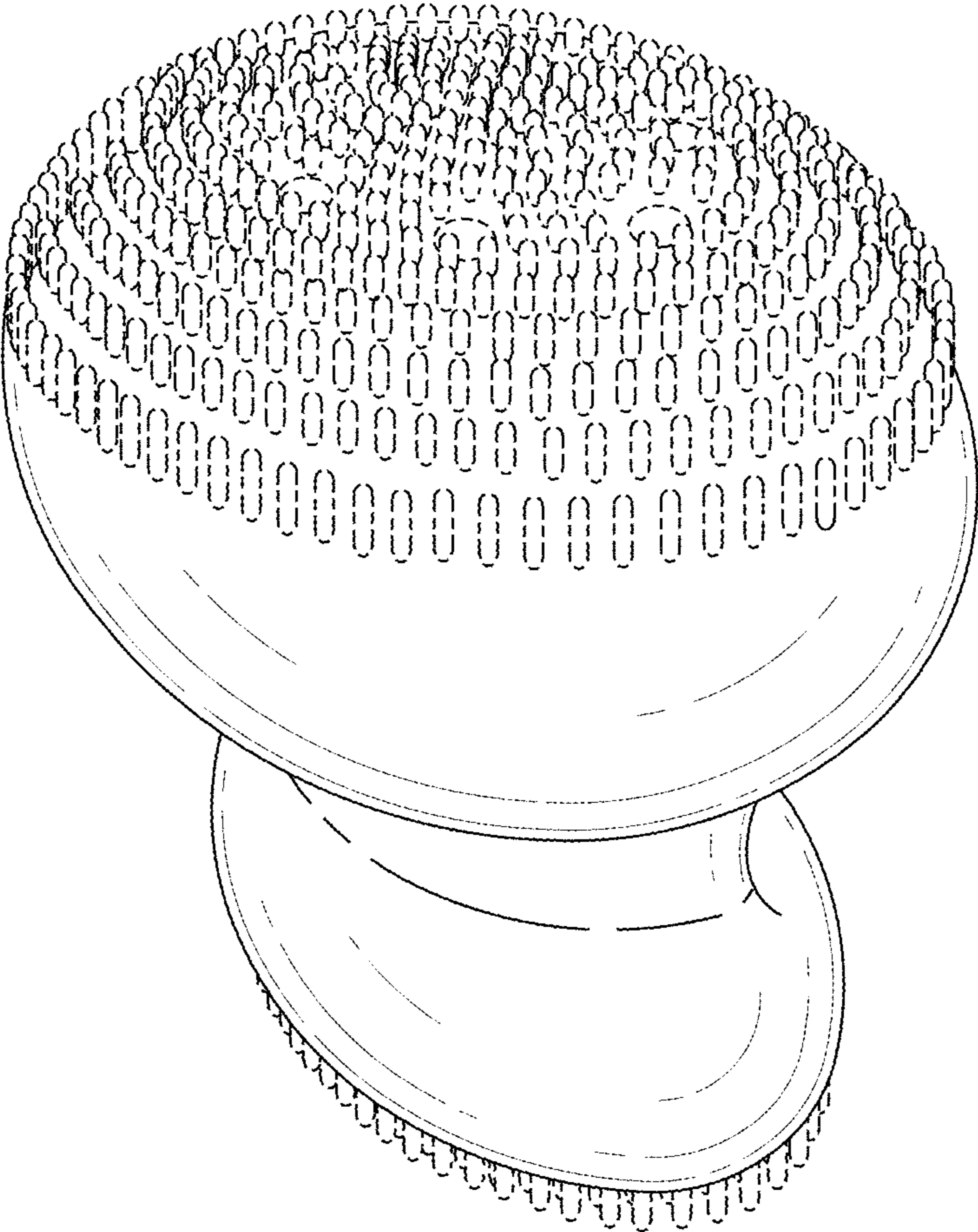

FIG. 1

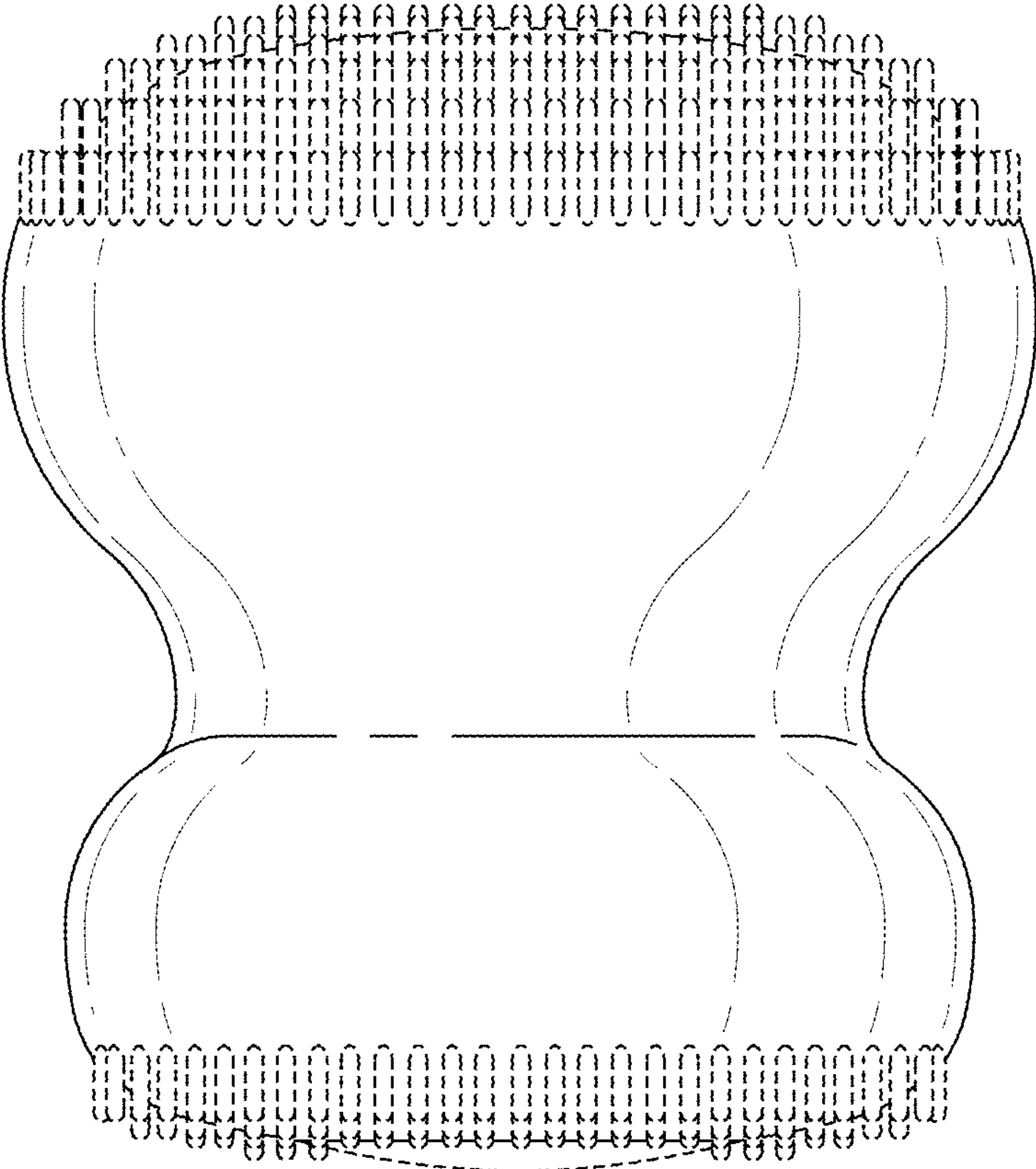

FIG. 2

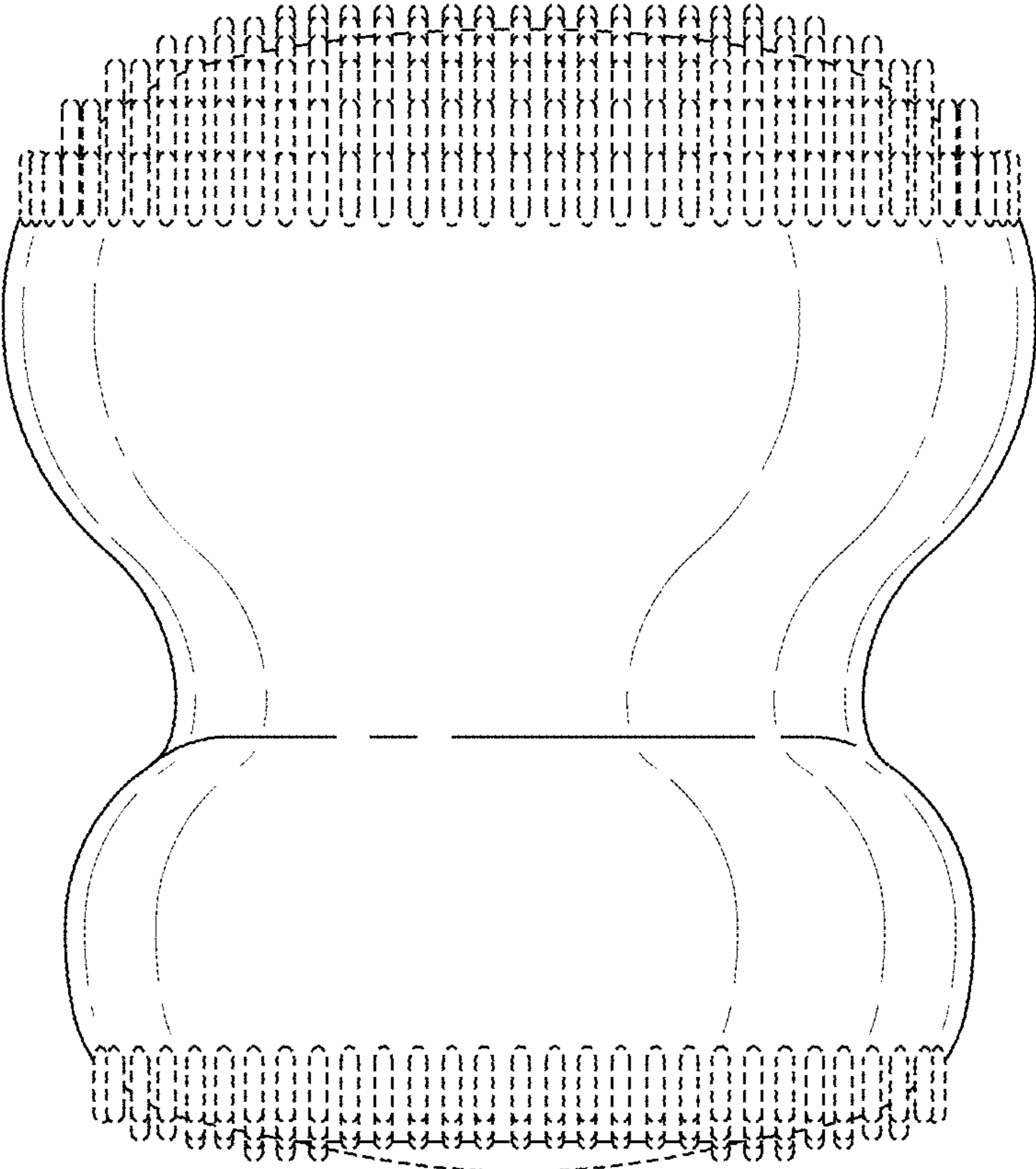

FIG. 3

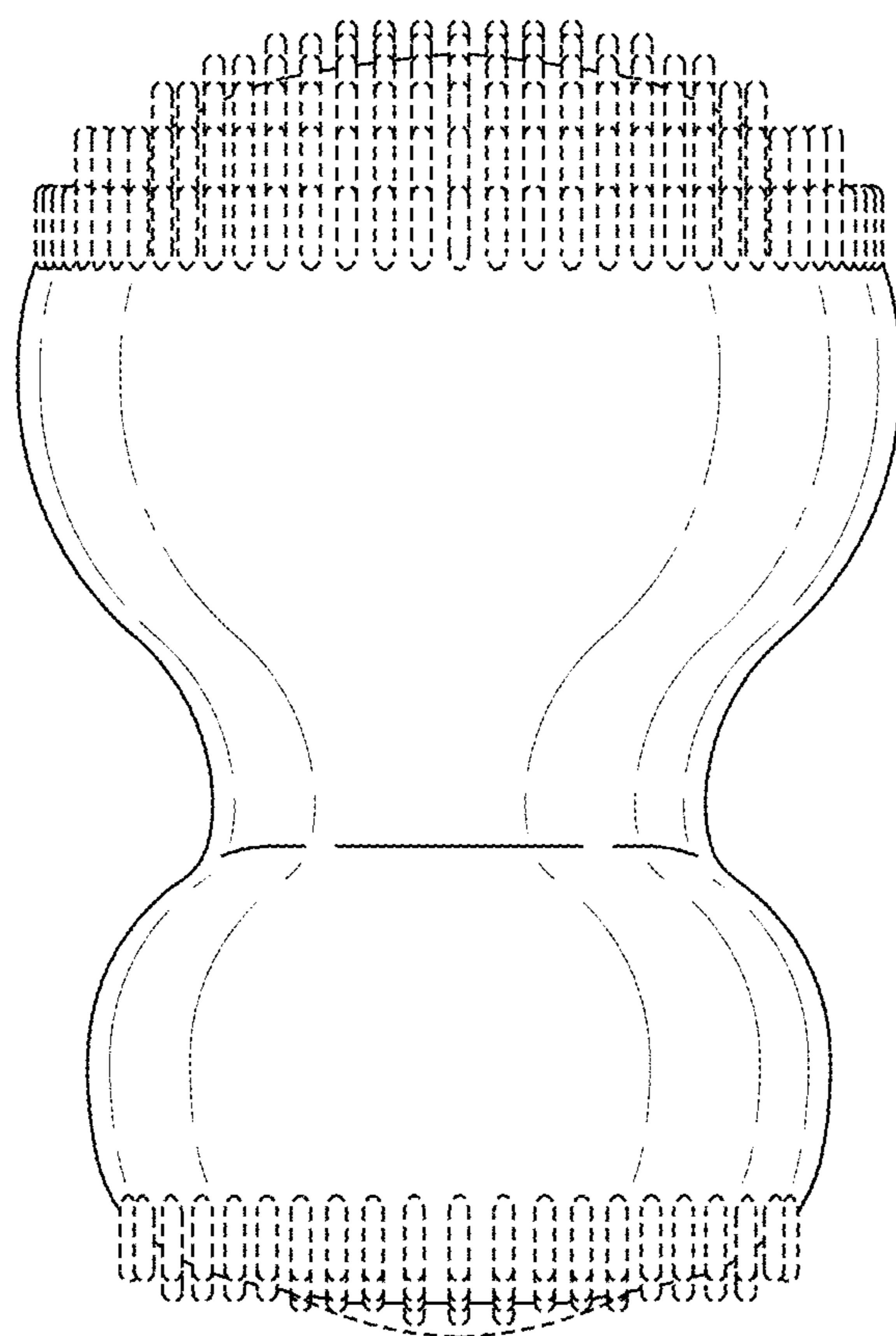

FIG. 4

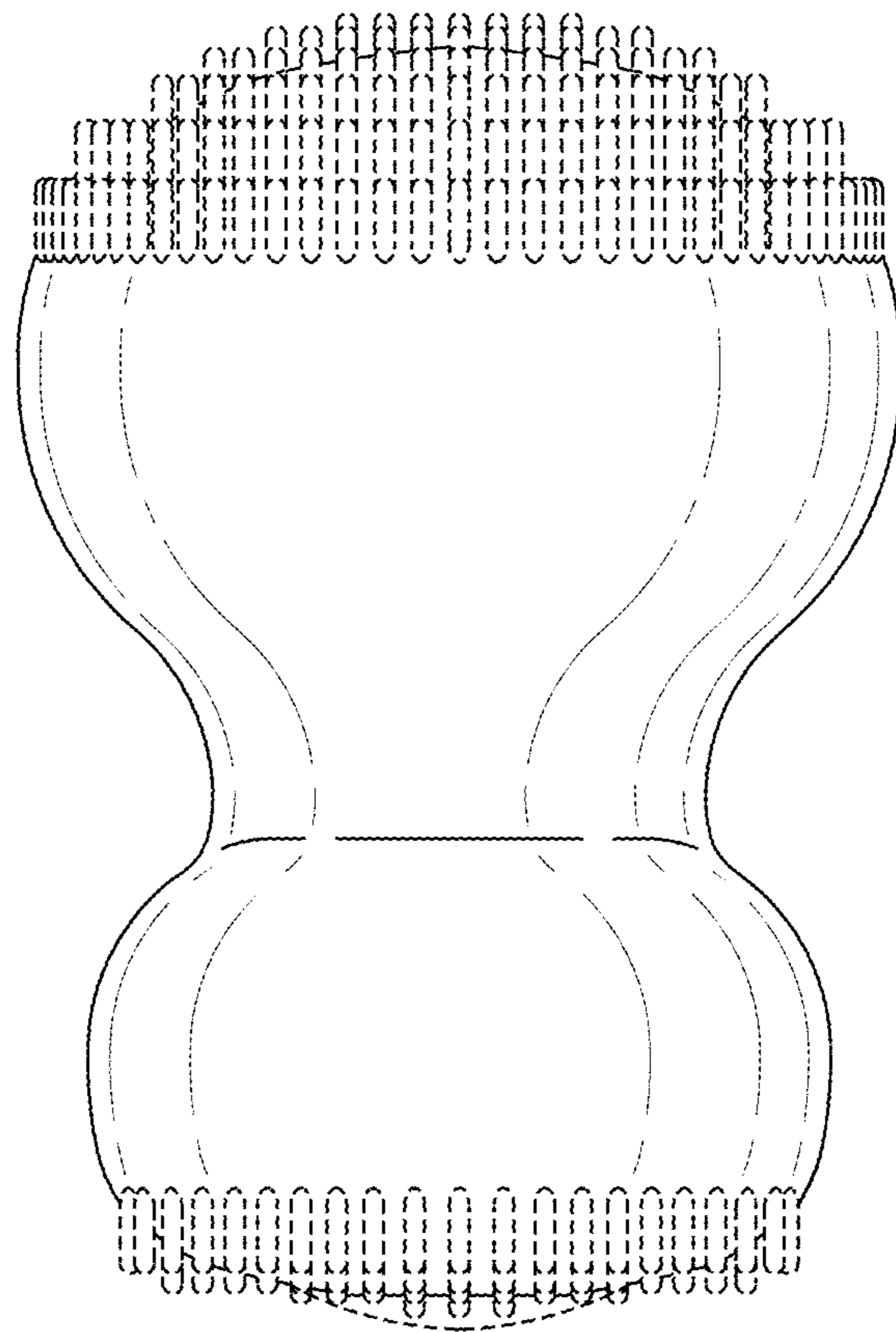

FIG. 5

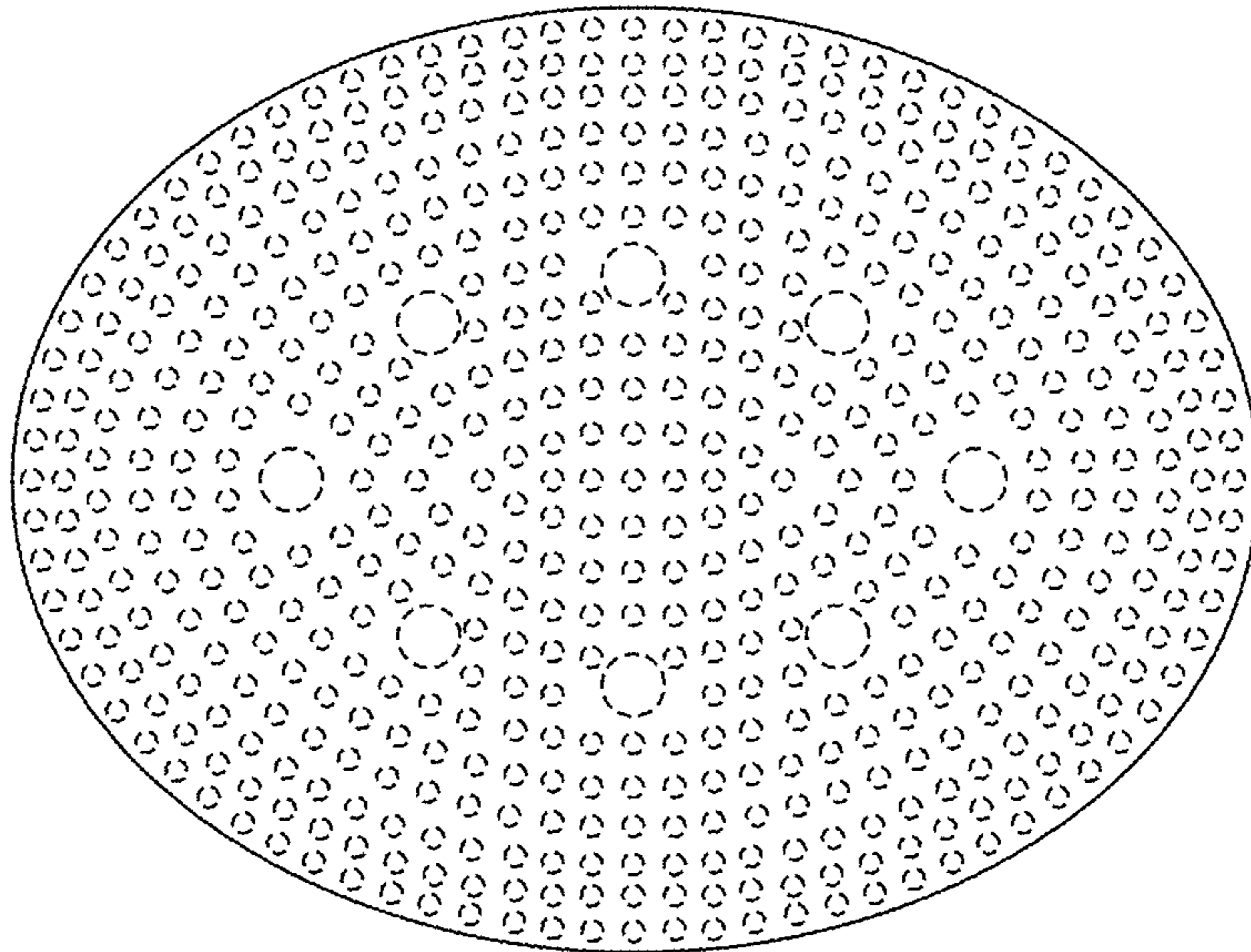

FIG. 6

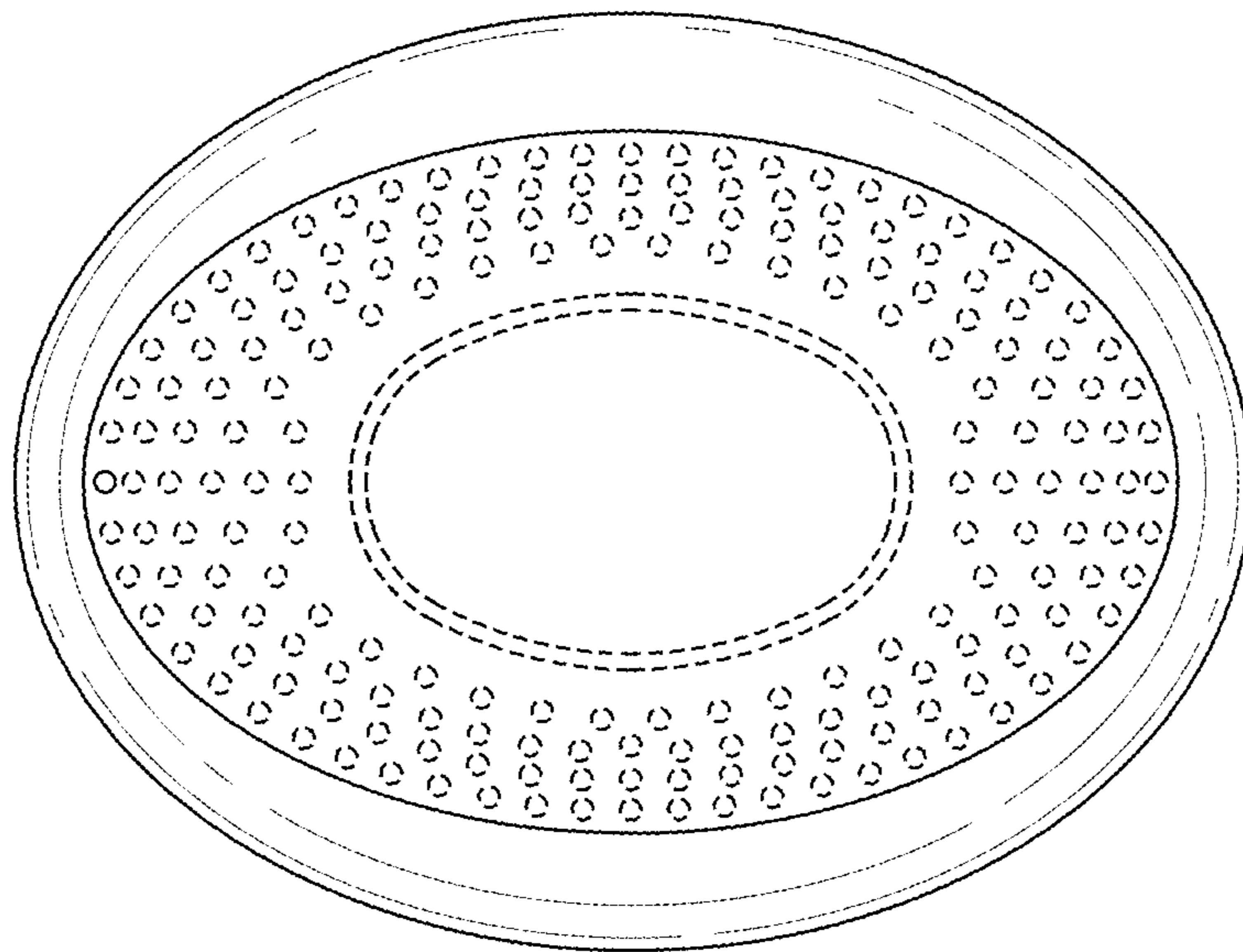

FIG. 7