

US00D964565S

(12) **United States Design Patent** (10) **Patent No.:** **US D964,565 S**
Olson (45) **Date of Patent:** **** Sep. 20, 2022**

(54) **BORING SURGICAL TOOL**

(71) Applicant: **Daniel J. Olson**, Erie, PA (US)

(72) Inventor: **Daniel J. Olson**, Erie, PA (US)

(**) Term: **15 Years**

(21) Appl. No.: **29/733,468**

(22) Filed: **May 2, 2020**

(51) **LOC (13) Cl.** **24-02**

(52) **U.S. Cl.**
USPC **D24/147**

(58) **Field of Classification Search**

USPC D24/146-147, 107-108, 110, D24/110.4-110.6, 111-122, 127-128, D24/130, 133, 140-141, 145-147, 152, D24/155-156, 172, 186, 190, 200, D24/206-207, 215, 124-125; D15/21-29, 138-140; D8/70, 354
CPC . A61B 17/1615; A61B 17/1697; A61B 1/303; A61B 5/150045; A61F 5/455; A61F 5/4553; A61F 13/2045; A61F 6/06; A61F 6/08; A61F 6/12; A61F 2/04; A61F 2/005; A61F 2/0009; A61F 2/0027; A61F 2/0036; A61F 2/0045; A61F 13/26; A61F 13/266; A61F 5/44; A61F 9/0008; A61F 9/0026; A61F 2230/0091; A61F 2250/0004; A61F 7/02; A61F 7/03; A61F 7/08; A61F 7/10; A61F 7/106; A61F 2207/0001; A61F 2007/0004; A61F 9/026; A61F 9/04; A61F 13/124; A61H 21/00; A61H 19/00; A61H 19/40; A61H 19/44; A61H 35/02; A61H 2201/0153; A61J 1/00; A61J 1/05; B65D 47/18; B65D 83/30; B01L 3/0282; A61M 35/003; A61M 35/00; A61M 2210/0612

See application file for complete search history.

(56) **References Cited**

U.S. PATENT DOCUMENTS

2,816,737 A 12/1957 Kinard et al.
4,616,638 A 10/1986 Griggs
4,710,075 A 12/1987 Davison
4,800,873 A 1/1989 Audell

(Continued)

Primary Examiner — Samantha Q Lawrence

Assistant Examiner — Holly M Rodriguez

(74) *Attorney, Agent, or Firm* — Jon L. Woodard;
Woodard International Law

(57) **CLAIM**

What is claimed the ornamental design for a boring surgical tool, as shown and described.

DESCRIPTION

FIG. 1 is a top front perspective view of a boring surgical tool with right, clockwise-boring threads according to one embodiment of the invention;

FIG. 2 is a side view of the boring surgical tool of FIG. 1; FIG. 3 is a front view of the boring surgical tool of FIG. 1; FIG. 4 is a top view of the boring surgical tool of FIG. 1; FIG. 5 is a bottom view of the boring surgical tool of FIG. 1;

FIG. 6 is a front, cross sectional view of the boring surgical tool of FIG. 1 taken along line 6-6 of FIG. 1;

FIG. 7 is a top front perspective view of a boring surgical tool with left, counterclockwise-boring threads according to one embodiment of the invention;

FIG. 8 is a side view of the boring surgical tool of FIG. 7; FIG. 9 is a front view of the boring surgical tool of FIG. 7; FIG. 10 is a top view of the boring surgical tool of FIG. 7; FIG. 11 is a bottom view of the boring surgical tool of FIG. 7; and,

FIG. 12 is a front, cross sectional view of the boring surgical tool of FIG. 7 taken along line 12-12 of FIG. 7.

1 Claim, 8 Drawing Sheets

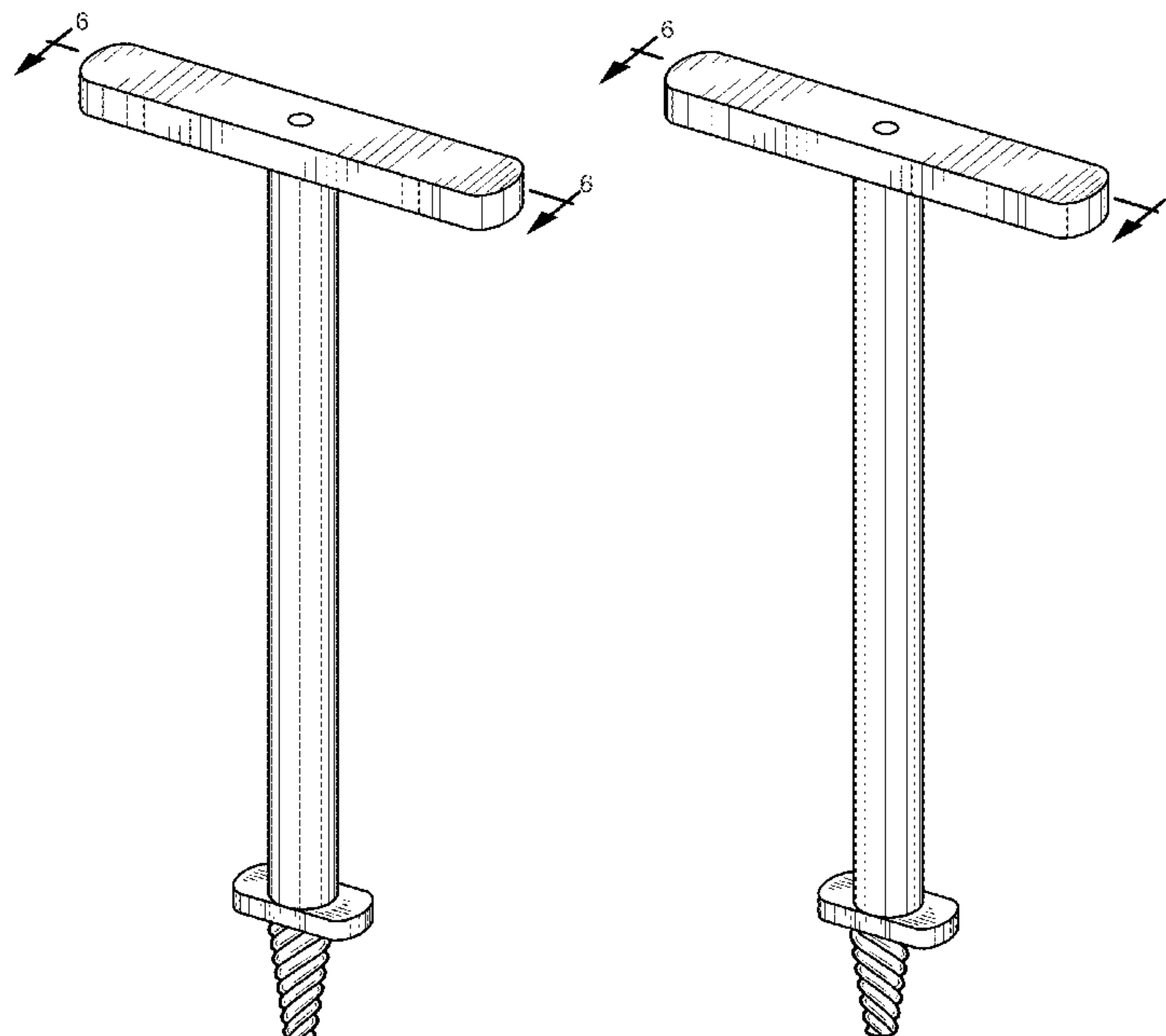

(56)

References Cited

U.S. PATENT DOCUMENTS

D313,471 S * 1/1991 Bremer D24/147
5,049,150 A * 9/1991 Cozad A61B 17/8866
606/80
5,147,376 A * 9/1992 Pianetti A61B 17/3417
411/411
D598,096 S * 8/2009 Petersen D24/133
D600,346 S * 9/2009 Petersen D24/140
8,236,006 B2 8/2012 Hamada
8,998,923 B2 4/2015 Chirico et al.
9,289,249 B2 3/2016 Ramsay et al.
10,499,930 B2 12/2019 Yim
D915,593 S * 4/2021 Alenezi D24/152
2008/0195115 A1 * 8/2008 Oren A61B 17/1604
606/96
2012/0078315 A1 * 3/2012 Sweeney A61F 2/442
606/86 A
2021/0212838 A1 * 7/2021 Wright A61B 17/175

* cited by examiner

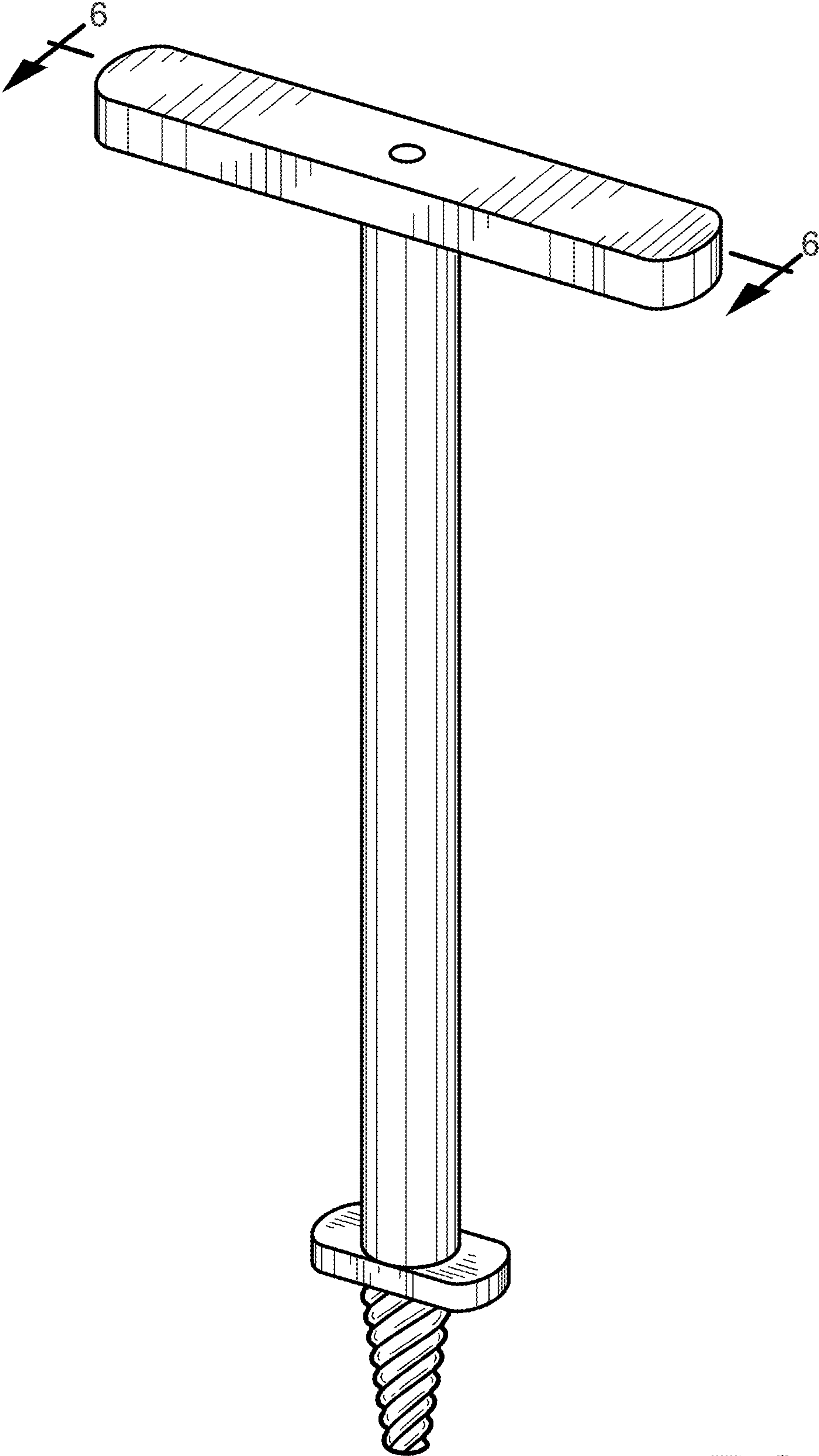

FIG. 1

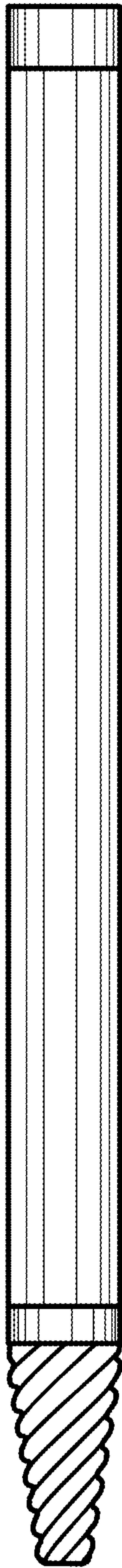

FIG. 2

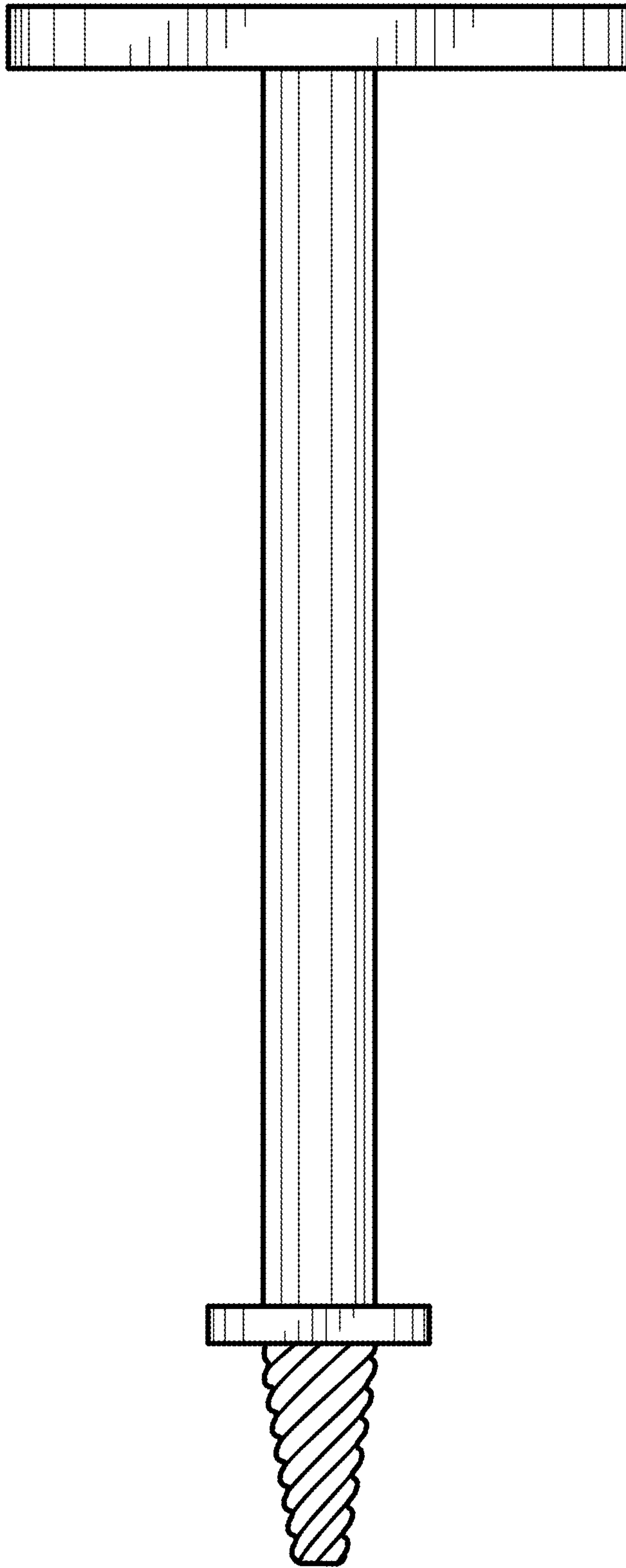

FIG. 3

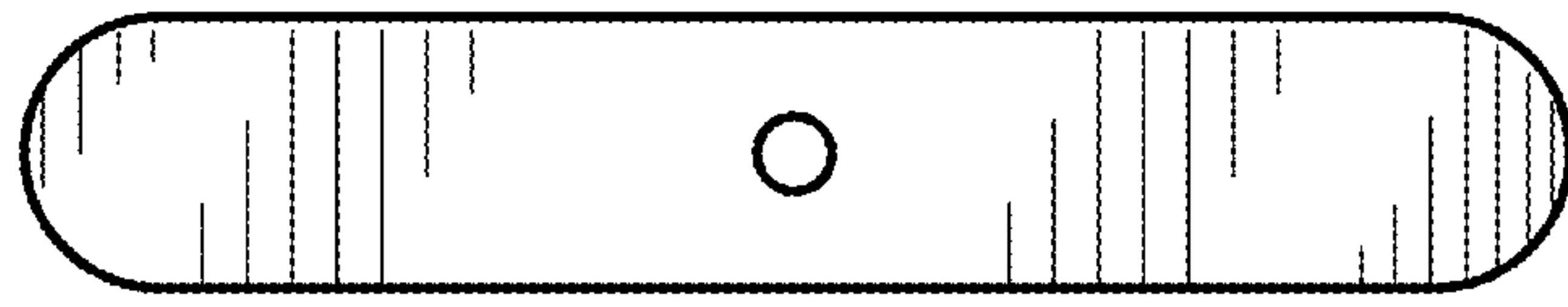

FIG. 4

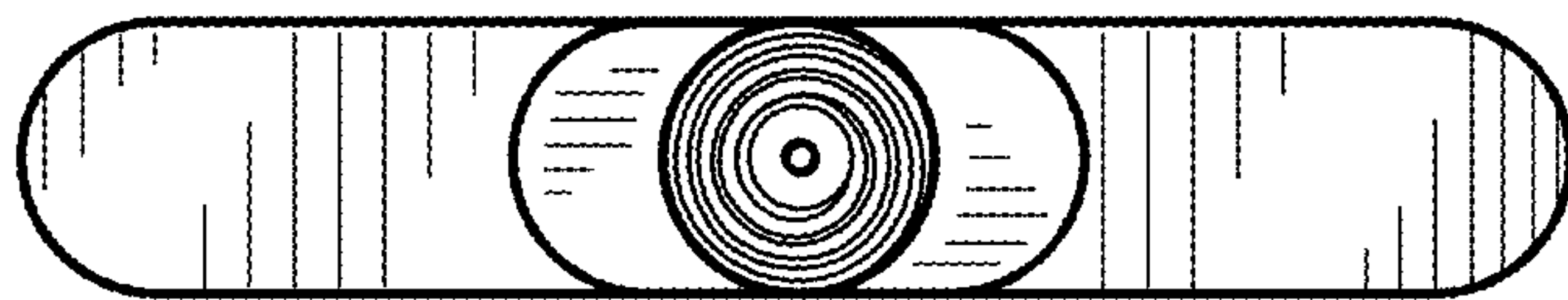

FIG. 5

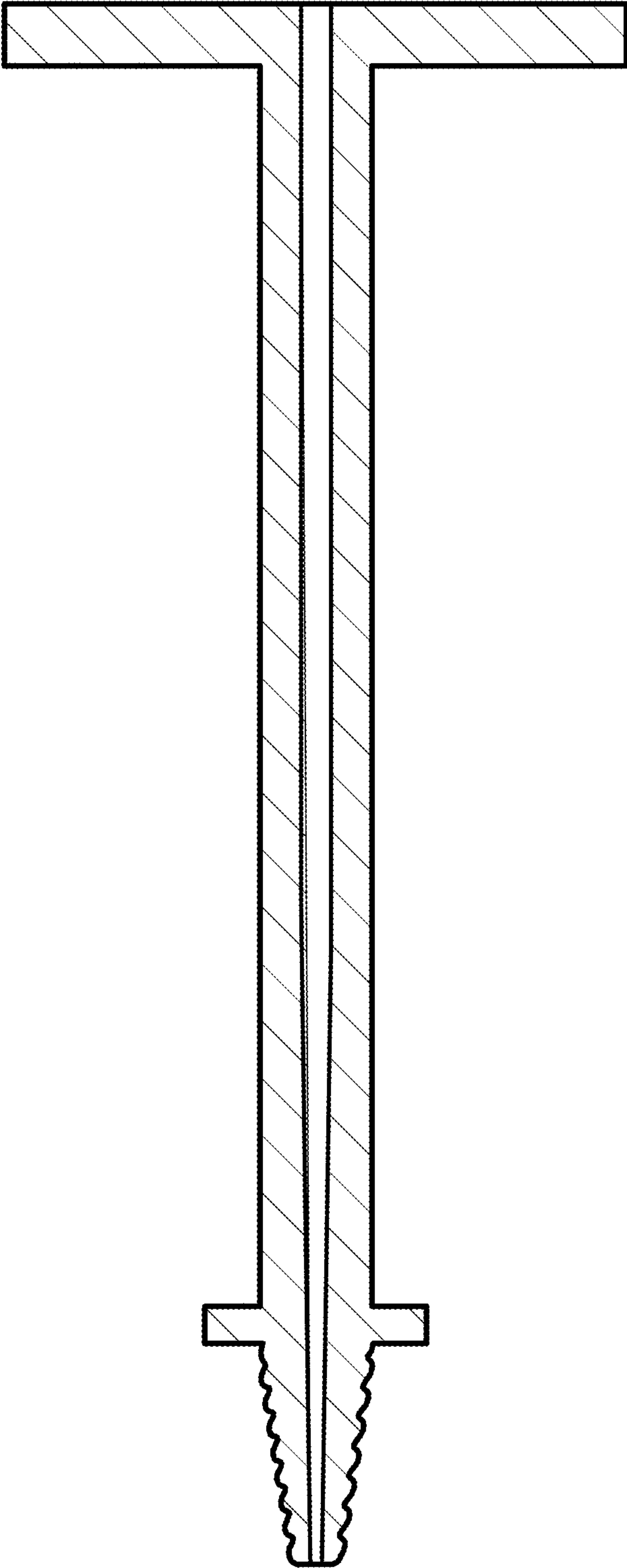

FIG. 6

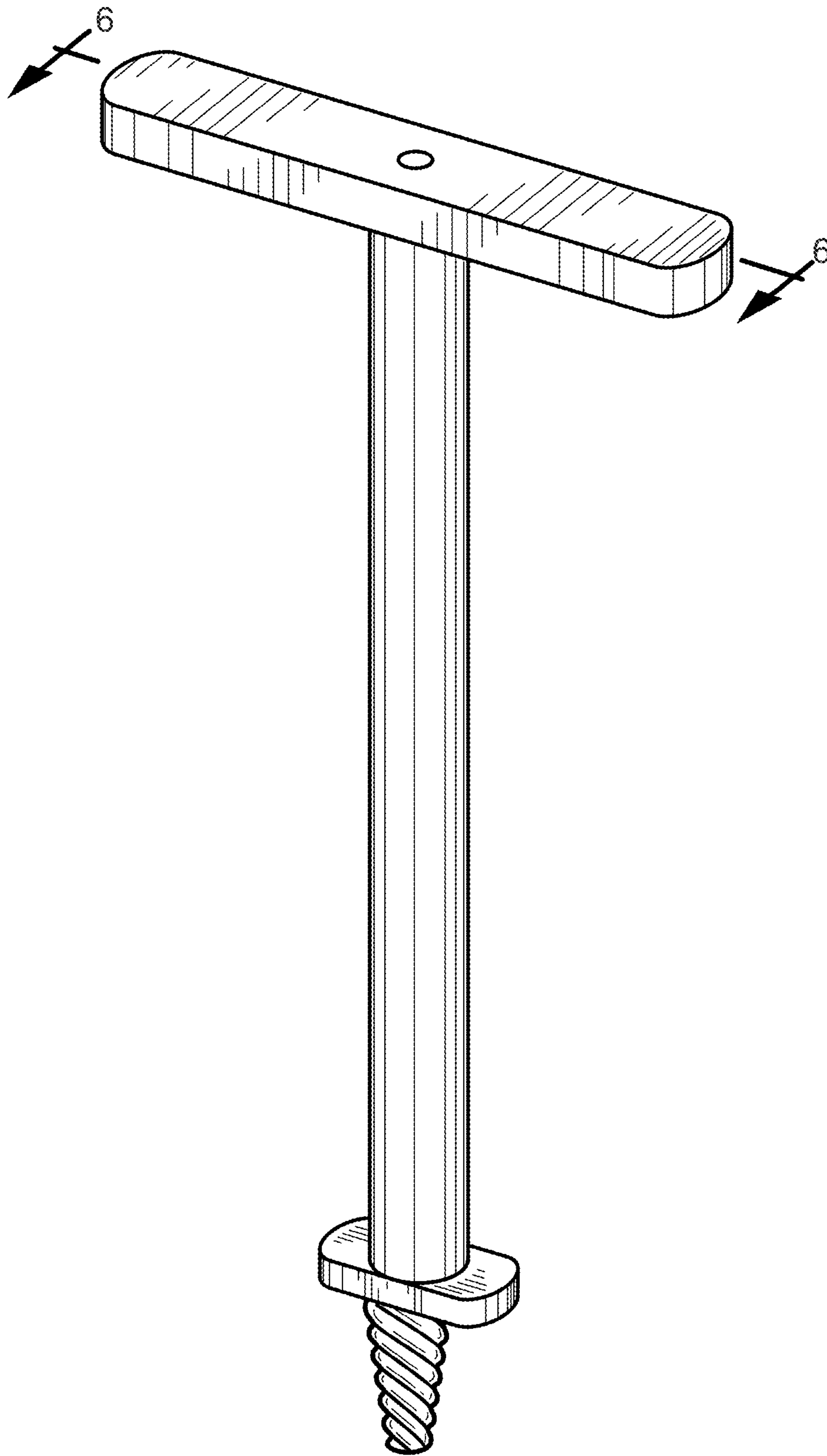

FIG. 7

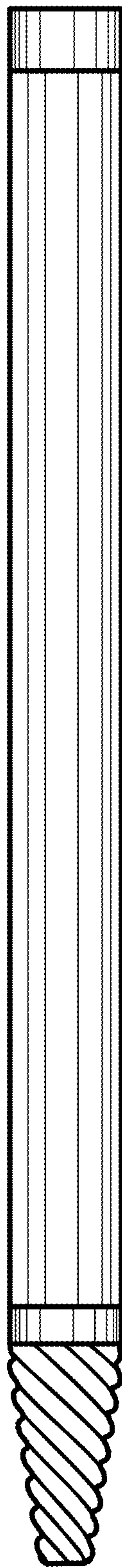

FIG. 8

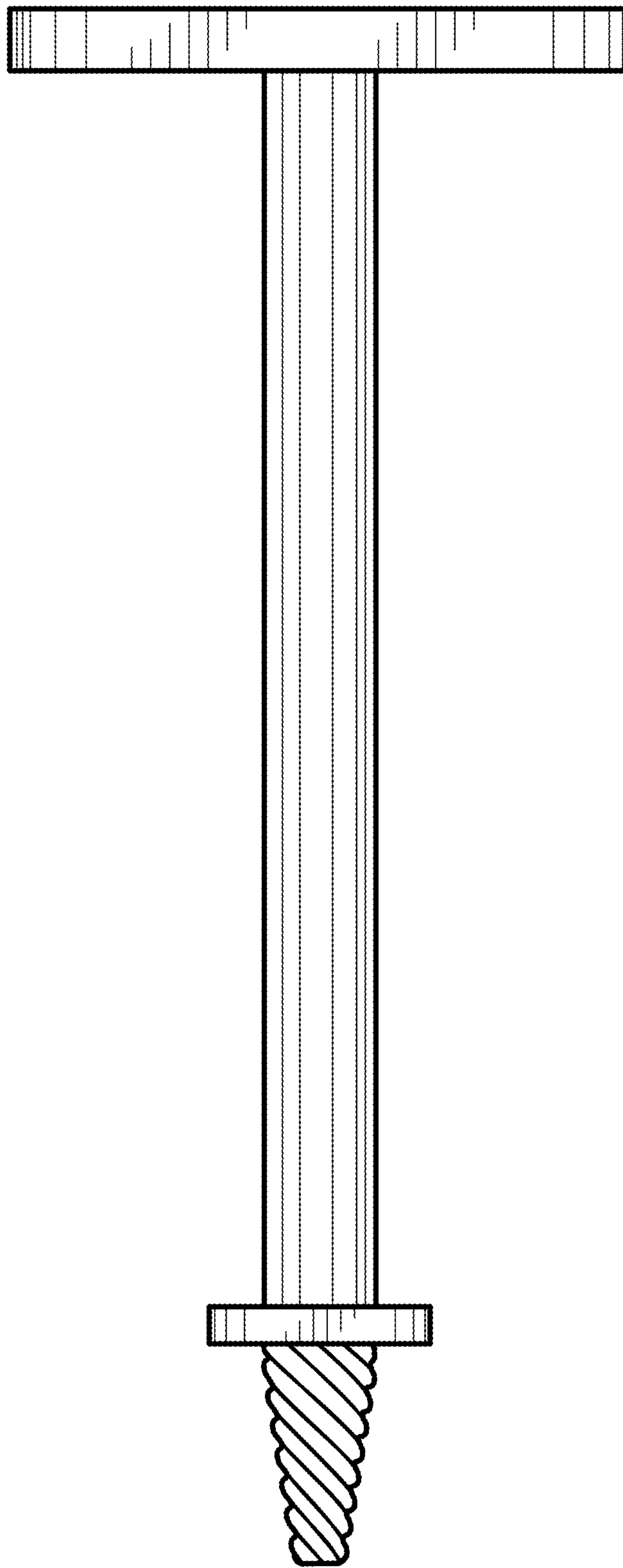

FIG. 9

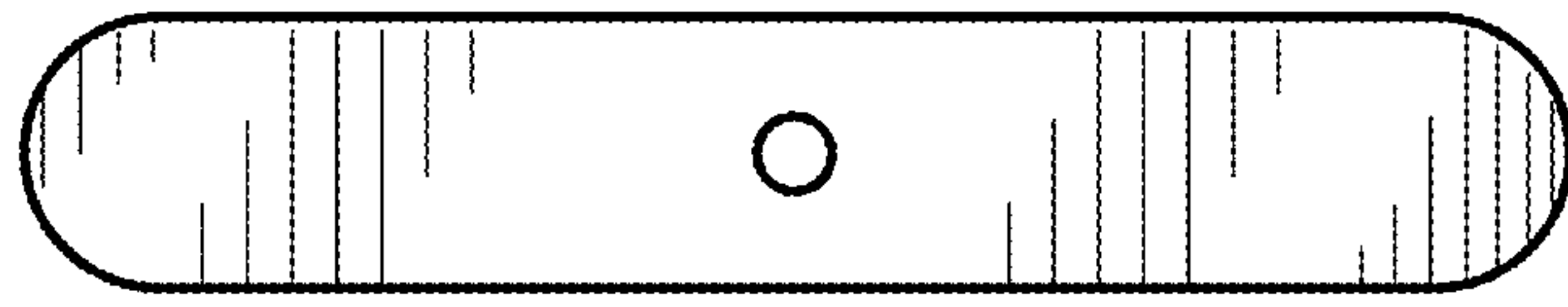

FIG. 10

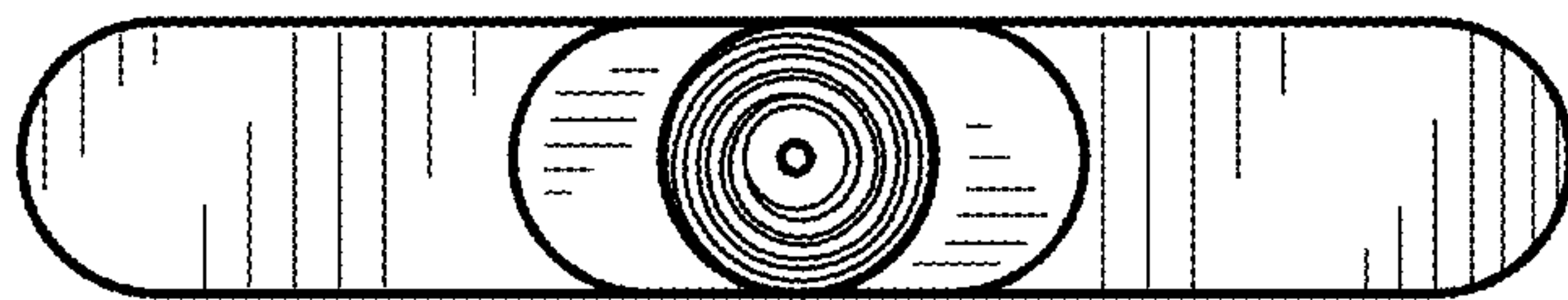

FIG. 11

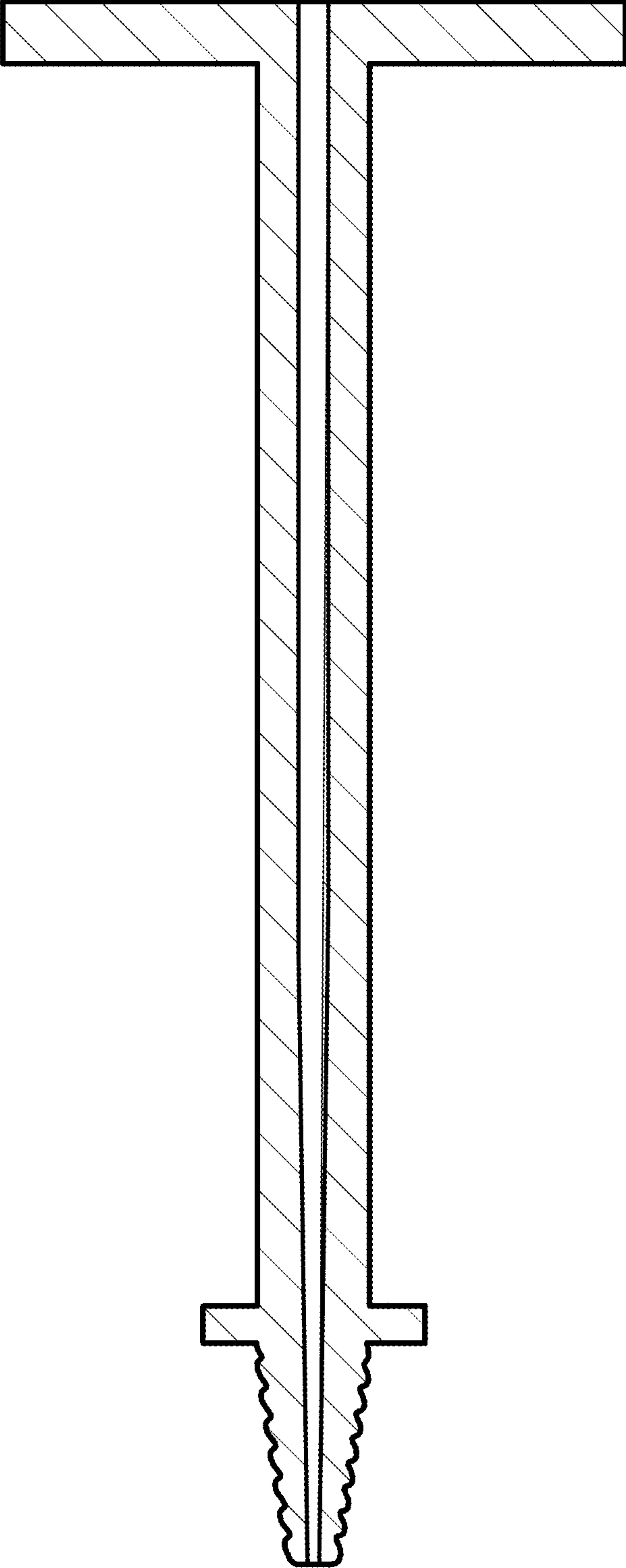

FIG. 12