



US00D964550S

(12) **United States Design Patent** (10) **Patent No.:** **US D964,550 S**
Hall, Jr. (45) **Date of Patent:** **** Sep. 20, 2022**

(54) **MASK CLIP**
(71) Applicant: **Walter Hall, Jr.**, North Richland Hills, TX (US)
(72) Inventor: **Walter Hall, Jr.**, North Richland Hills, TX (US)

8,505,170 B1 * 8/2013 Gray A45F 5/022
24/3.12
D693,733 S * 11/2013 Fujii D11/200
D702,106 S 4/2014 Weinberg
D713,290 S * 9/2014 Fildan D11/200
(Continued)

(**) Term: **15 Years**
(21) Appl. No.: **29/756,878**

CA 199306 * 3/2022
CN 103117462 A 5/2013
(Continued)

(22) Filed: **Oct. 30, 2020**
(51) **LOC (13) Cl.** **29-02**
(52) **U.S. Cl.**
USPC **D24/110.1**; D11/200
(58) **Field of Classification Search**
USPC D24/110.1, 106, 128; D11/200; D8/356, D8/394
CPC A41D 1/002; A41D 13/1161; A41D 13/11; A41D 13/0012; A41D 13/1184; A44B 99/00; A41F 1/00; E05D 3/12; A42B 1/247; A42B 7/00; A42B 1/244
See application file for complete search history.

FOREIGN PATENT DOCUMENTS

OTHER PUBLICATIONS

Helmet Holder Clip, Feb. 11, 2022, amazon.com [online], [site visited Apr. 25, 2022], Available from internet, URL: <https://www.amazon.com/Multifunction-Backpack-Snowboard-Accessories-Bracket%EF%BC%889/dp/B09S8VYZBZ/ref=sr_1_4?crid=59VCOCDQ49XT&keywords=Ski+Helmet+Clip+Face+Mask+Holder+Clip&qid=1650920850&srefix=ski+helmet+clip+face+mask+holder+clip%2Caps%2C72&sr=8-4> (Year: 2022).*

Primary Examiner — Wendy L Arminio
Assistant Examiner — Maheen Khurshid

(56) **References Cited**
U.S. PATENT DOCUMENTS

D28,347 S * 3/1898 Morrell D8/395
D146,923 S * 6/1947 Leming D11/200
D333,257 S * 2/1993 Newcomer D8/394
D462,447 S * 9/2002 Doyle D24/190
D500,706 S * 1/2005 Guney D11/216
D568,782 S * 5/2008 Yang D11/200
D575,143 S * 8/2008 Kuo D8/394
D586,258 S * 2/2009 Guney D11/216
D588,498 S * 3/2009 Davidson D11/216
D607,712 S 1/2010 Kelleghan
D608,629 S 1/2010 Daugherty et al.
D612,765 S * 3/2010 Fildan D11/218
D616,559 S * 5/2010 Boyer D24/106
D639,937 S * 6/2011 Gray D24/128
D669,764 S 10/2012 Kelleghan
D672,031 S * 12/2012 Hunt D24/106
D673,262 S * 12/2012 Omura D14/223

(57) **CLAIM**

The ornamental design for a mask clip, as shown and described.

DESCRIPTION

FIG. 1 is a top-front-right perspective view of a mask clip showing my new design;
FIG. 2 is a bottom-rear-left perspective view thereof;
FIG. 3 is a front elevation view thereof;
FIG. 4 is a rear elevation view thereof;
FIG. 5 is a top plan view thereof;
FIG. 6 is a bottom plan view thereof;
FIG. 7 is a left elevation view thereof; and,
FIG. 8 is a right elevation view thereof.

1 Claim, 8 Drawing Sheets

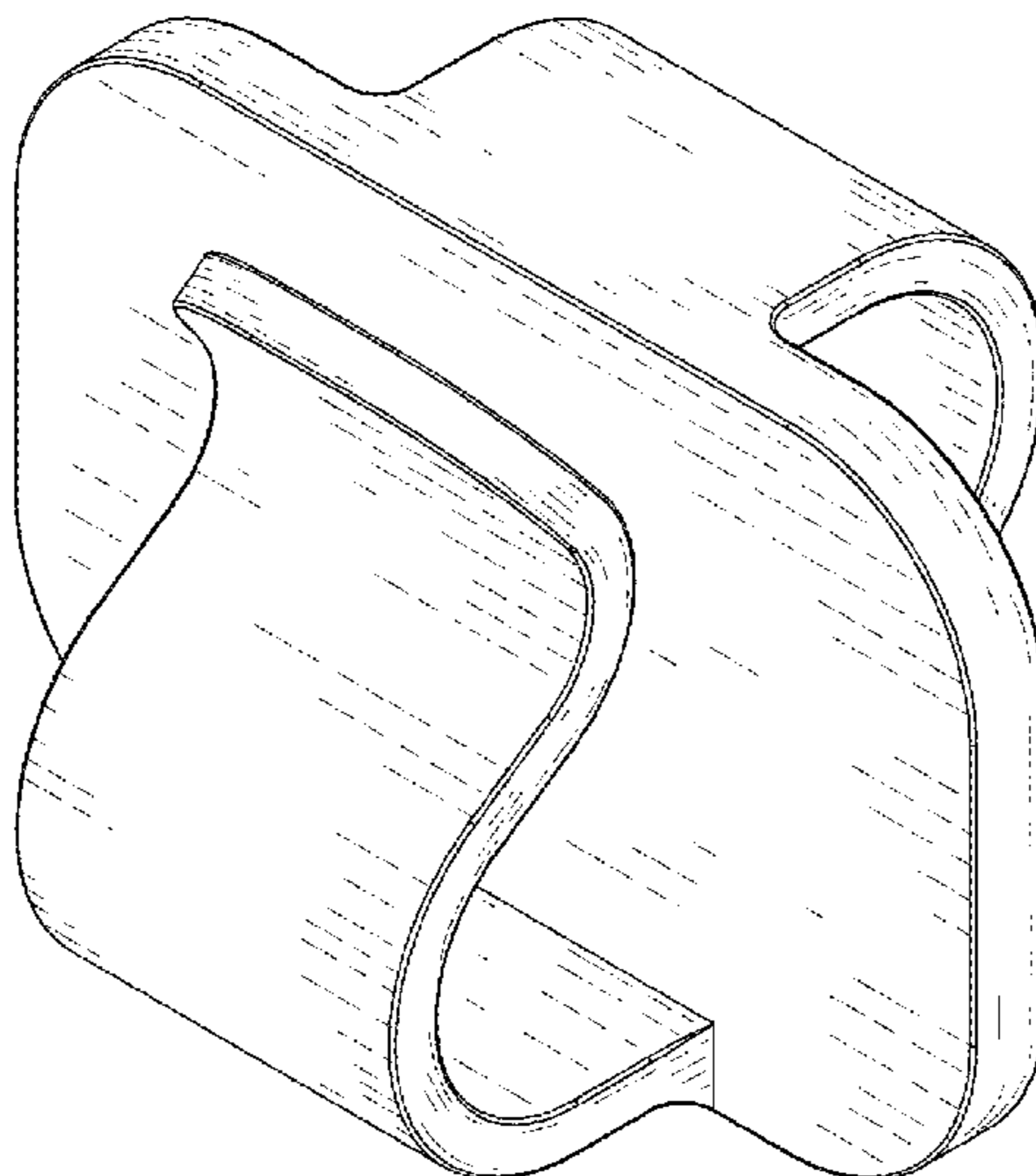

(56)

References Cited

U.S. PATENT DOCUMENTS

D743,842 S * 11/2015 La Guzza D24/110.1
 D820,219 S * 6/2018 Herriford
 D833,598 S * 11/2018 Nordensson Spångberg
 D24/128
 10,226,092 B1 * 3/2019 Parker A45F 5/021
 D948,029 S * 4/2022 Hopta D8/394
 2004/0045133 A1 * 3/2004 Buettell A45F 5/02
 24/3.12
 2020/0068967 A1 * 3/2020 Efrat A41F 1/00
 2020/0085148 A1 * 3/2020 Gall A44B 11/06
 2022/0079267 A1 * 3/2022 Mason A41D 13/1161

FOREIGN PATENT DOCUMENTS

CN 305956339 * 7/2020
 KR 300946388.0000 * 3/2018

OTHER PUBLICATIONS

LuckyShe Ear Savers Mask Clips Extender, Apr. 15, 2020, amazon.com [online], [site visited Apr. 25, 2022], Available from internet,

URL: <https://www.amazon.com/LuckyShe-Savers-Extender-Transparent-Acrylic/dp/B087X8G237/ref=sr_1_4?crd=3QJV6QVV8O2SJ&keywords=s%2Bshaped%2Bmask%2Bclip&qid=1651004562&s=hpc&sprefix=s%2Bshaped%2Bmask%2Bclip%2Chpc%2C91&sr=1-4&th=1> (Year: 2020).*

Ripstop, Double-Ended Mitten Hook, <<https://ripstopbytheroll.com/collections/plastic-hooks/products/double-ended-mitten-hook>>.

Alibaba.com, Factory Bag Accessory 10mm S Shape Ornament Plastic Snap Swivel Hook, <https://www.alibaba.com/product-detail/Factory-Bag-Accessory-10mm-S-Shape_60669145311.html?spm=a2700.7724857.normalList.2.139a1dfeBG923i&s=p&fullFirstScreen=true>.

Presco, S Hooks—Metal and Plastic, <<https://presco.uk/products/s-hook-metal-plastic?variant=39280692658367>>.

Aliexpress, 90/100/115MM Durable Stainless Steel Double Ended Clip Hook Bolt Snap Scuba Diving Buckle Diving Kayak Paddle Leash Accessories, <<https://aliexpress.ru/item/32966609054.html>>.

ExportersIndia.com, <<https://www.exportersindia.com/clipsindia/>>.

Ebay, Brass S shaped Detachable Quick release Keychain Belt Clip keyring holder H437, <<https://www.ebay.com/itm/Brass-S-shaped-Detachable-Quick-release-Keychain-Belt-Clip-keyring-holder-H437-/253097902111>>.

* cited by examiner

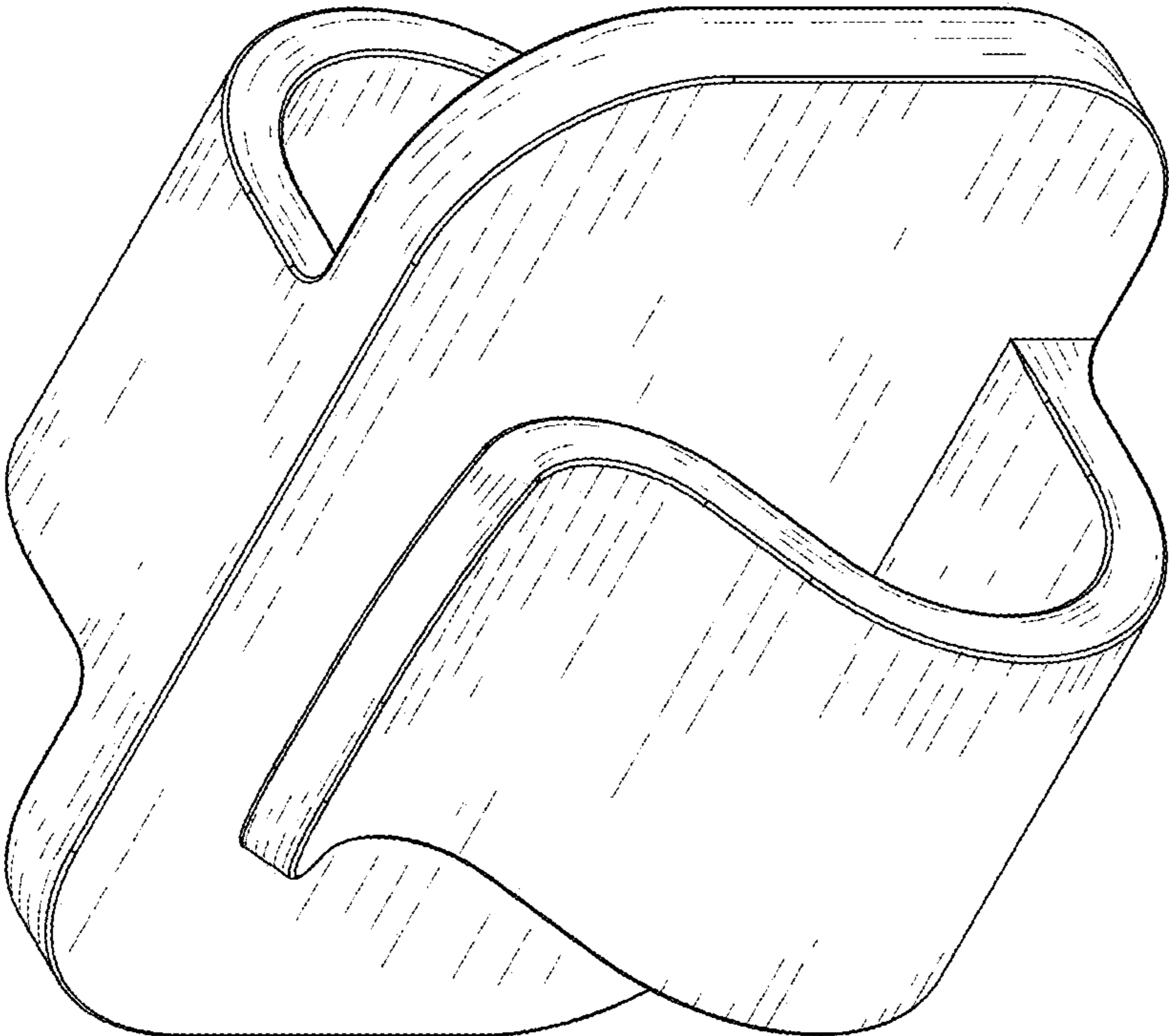

FIG. 1

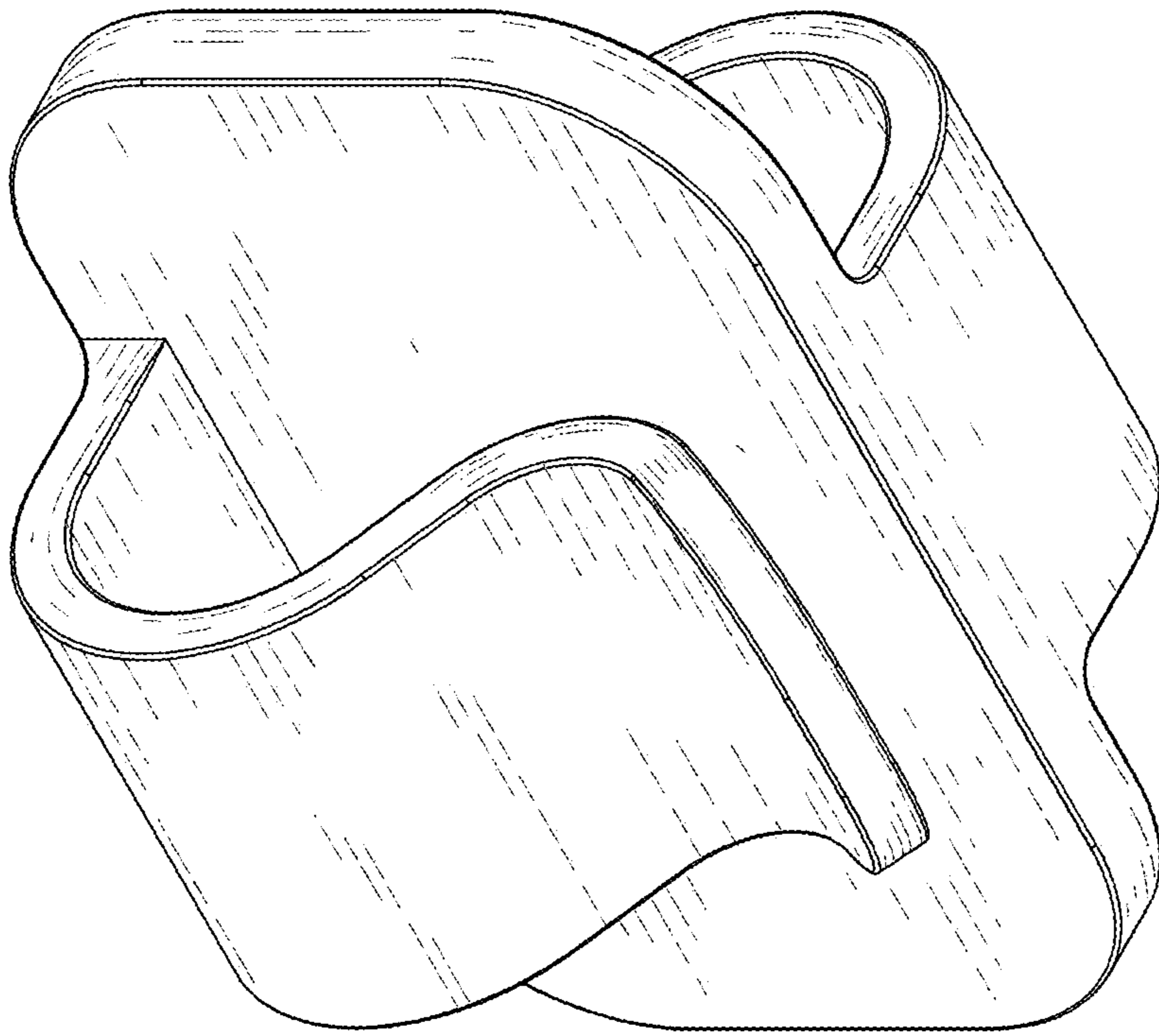

FIG. 2

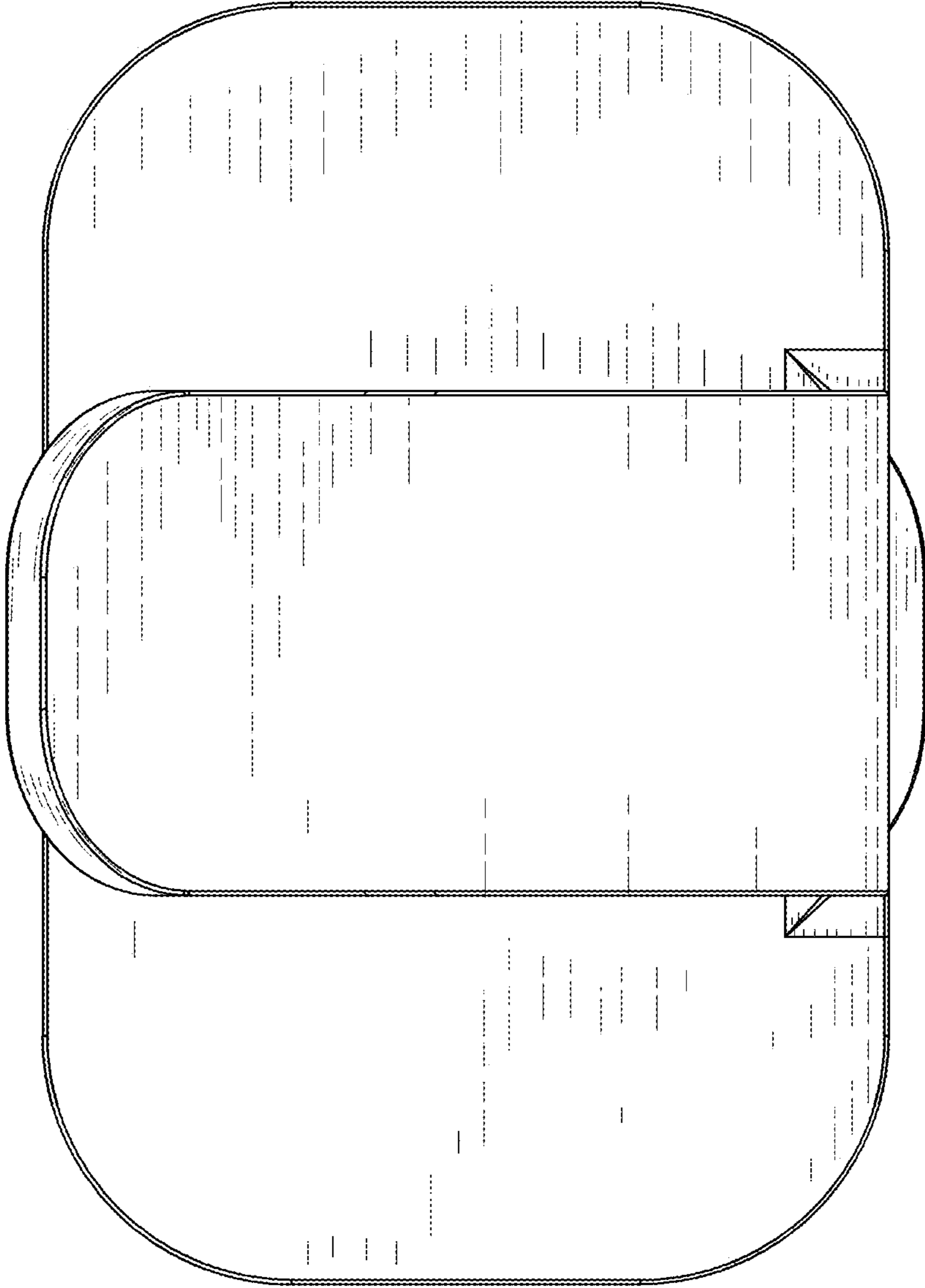

FIG. 3

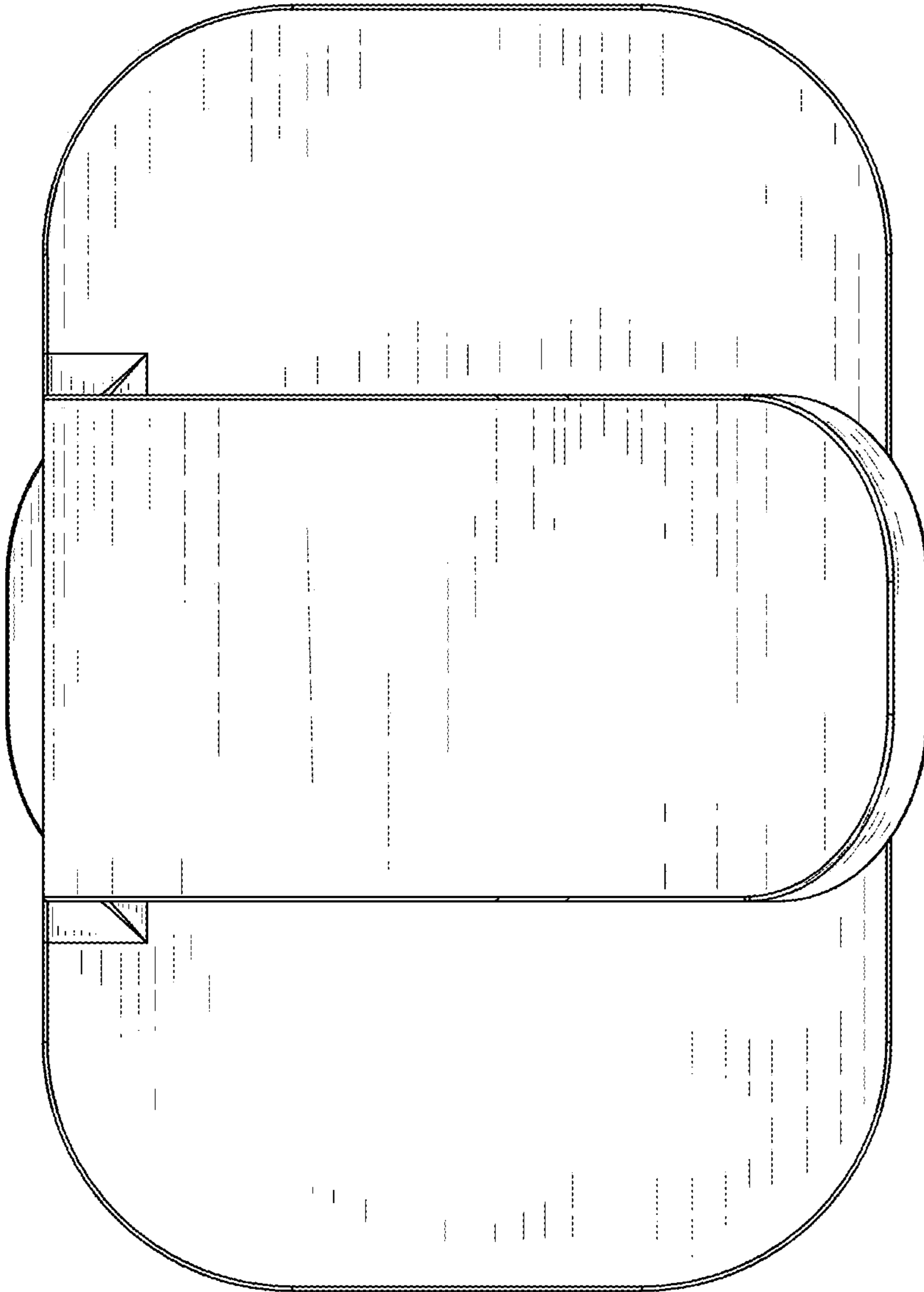

FIG. 4

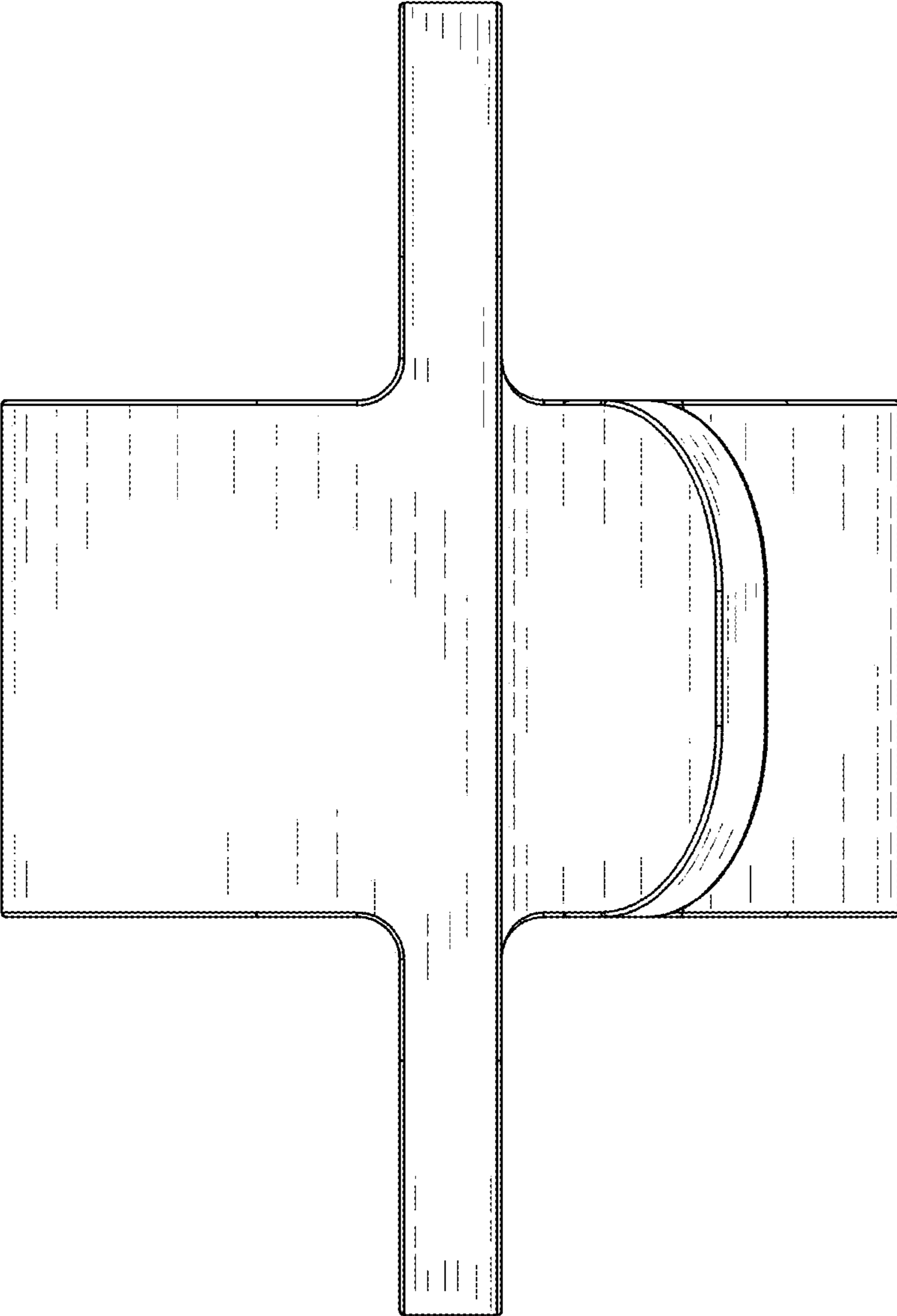

FIG. 5

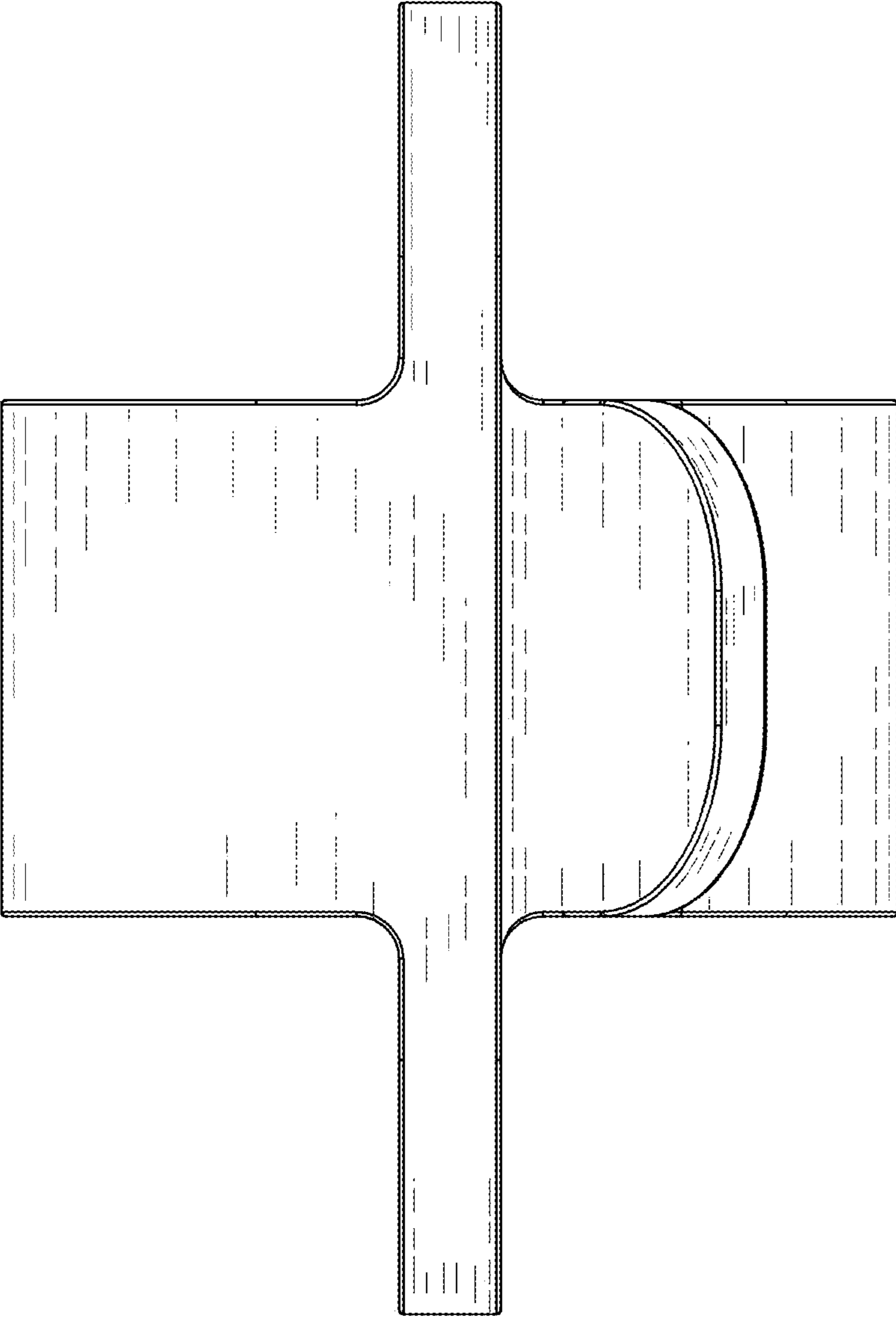

FIG. 6

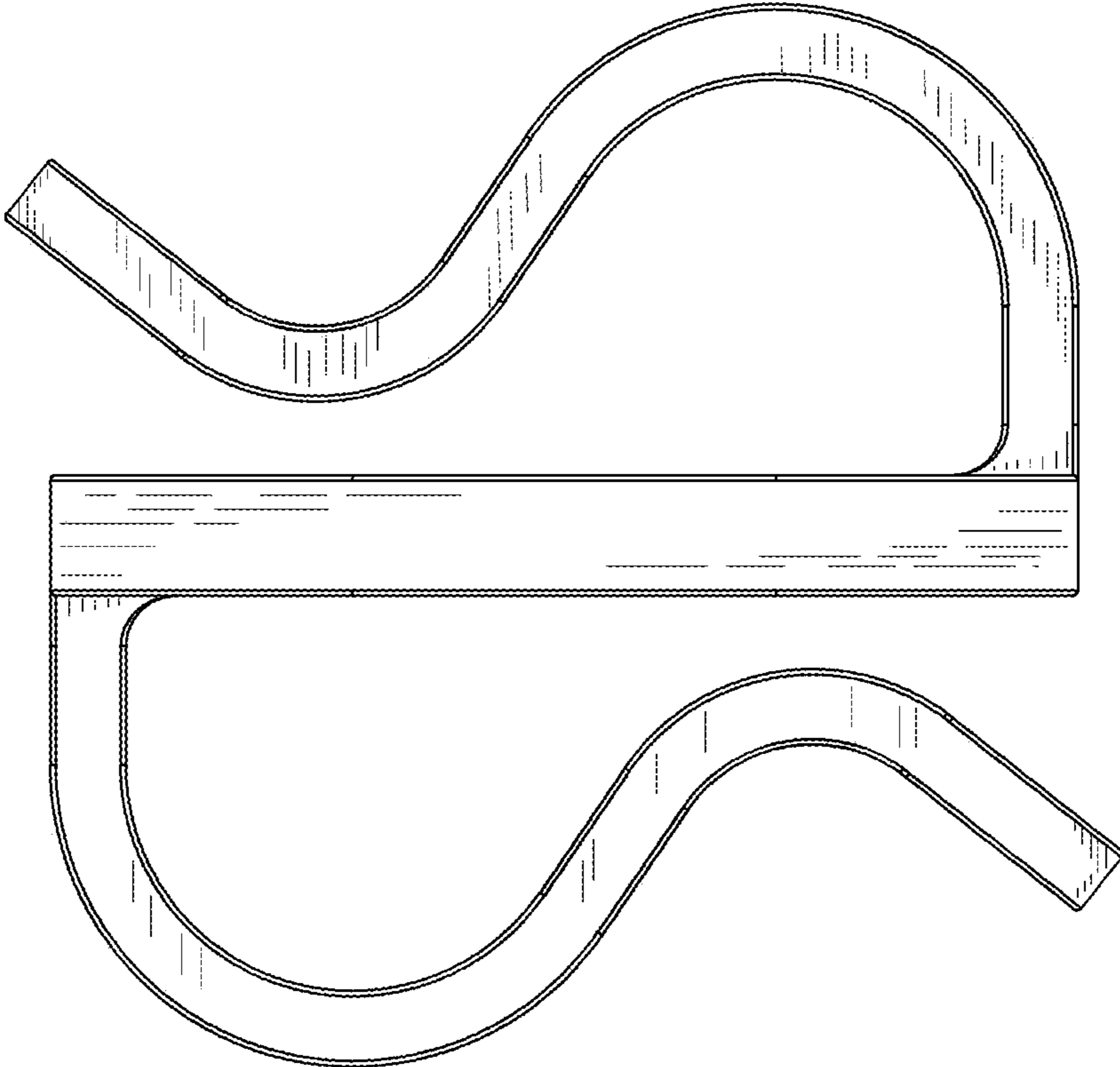

FIG. 7

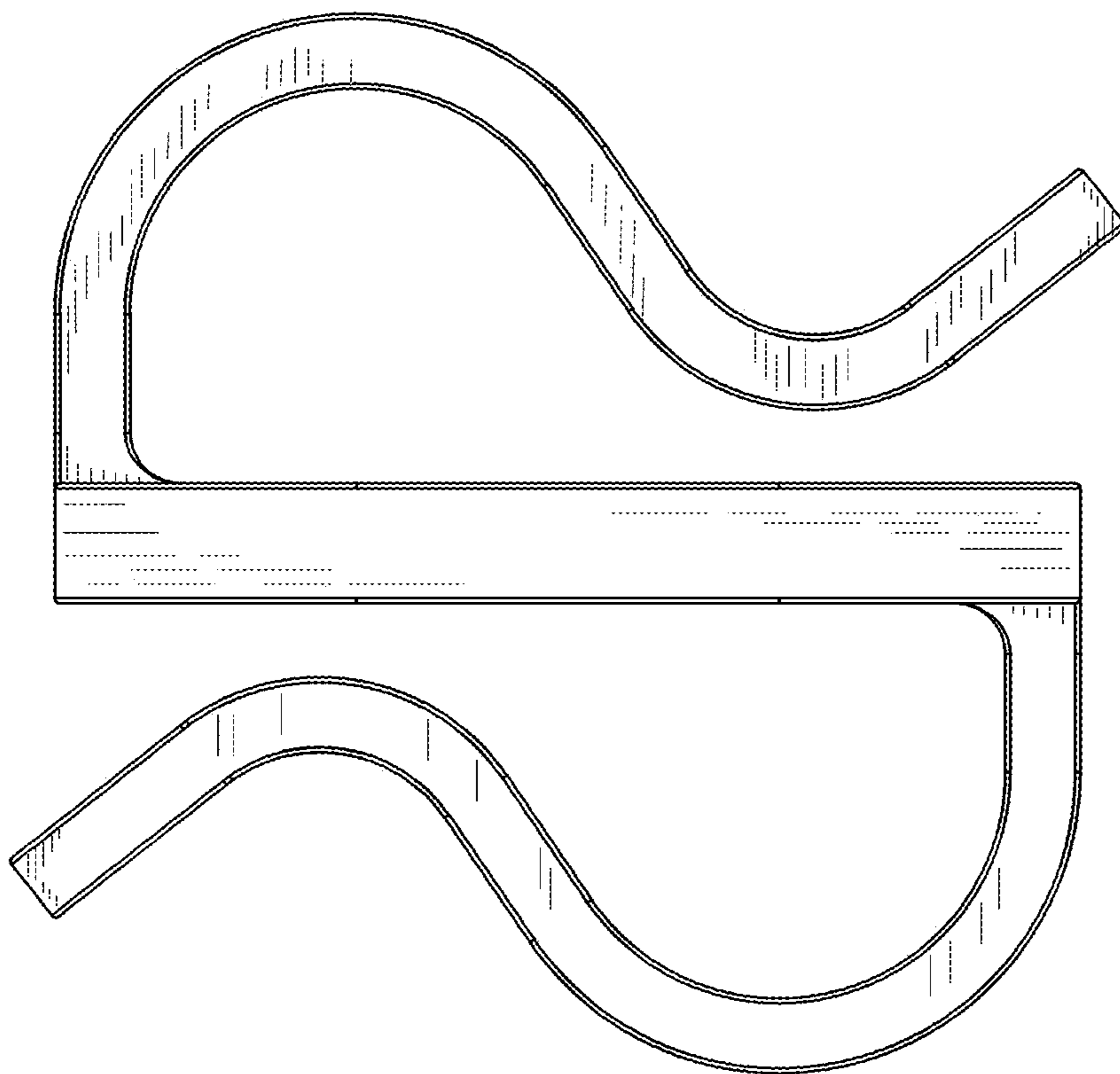

FIG. 8