



US00D964498S

(12) **United States Design Patent** (10) **Patent No.:** **US D964,498 S**
Zhang et al. (45) **Date of Patent:** **** Sep. 20, 2022**

(54) **TENT**

(71) Applicant: **EAGLE OUTDOOR CAMPING PRODUCTS CO., LTD.**, Quzhou (CN)

(72) Inventors: **Zhengfeng Zhang**, Quzhou (CN);
Shuaiguang Deng, Quzhou (CN);
Huifen Wu, Quzhou (CN)

(73) Assignee: **EAGLE OUTDOOR CAMPING PRODUCTS CO., LTD.**, Quzhou (CN)

(**) Term: **15 Years**

(21) Appl. No.: **29/767,290**

(22) Filed: **Jan. 21, 2021**

(30) **Foreign Application Priority Data**

Dec. 31, 2020 (CN) 202030828200.2
Dec. 31, 2020 (CN) 202030828343.3

(51) **LOC (13) Cl.** **21-04**

(52) **U.S. Cl.**
USPC **D21/834**

(58) **Field of Classification Search**
USPC D21/834-840; D25/32, 16, 17, 56, 57,
D25/18, 22, 1; D12/401-404; D30/108
CPC E04H 15/00; E04H 15/02; E04H 15/18;
E04H 15/32; E04H 15/34; E04H 15/001;
E04H 15/003; E04H 15/005; E04H
15/006; E04H 15/008; E04H 15/06; E04H
15/08; E04H 15/14; E04H 15/16; E04H
15/20; E04H 15/22; E04H 15/26; E04H
15/28; E04H 15/30; E04H 15/60; E04H
15/62; E04H 15/54; E04H 15/40; E04H
15/42; E04H 15/425; E04H 15/36; E04H
15/38; E04H 2015/201-204; E04H 15/50;
E04H 15/44; E04H 15/46; E04H 15/48;
E04H 2015/205-209; E04H 6/005; E04H
15/58; Y10S 135/902; Y10S 135/904;
Y10S 135/907; Y10S 135/908; Y10S
135/90;

(Continued)

(56) **References Cited**

U.S. PATENT DOCUMENTS

3,375,836 A * 4/1968 Domeneghetti E04H 15/06
135/132
4,548,438 A * 10/1985 Myers E04H 15/38
296/26.02

(Continued)

OTHER PUBLICATIONS

Roofnest Falcon Aluminum Hardshell Roof Top Tent Date Reviewed:
Sep. 25, 2019. Retrieved from internet: <https://offroadtents.com/products/roofnest-falcon-aluminum-hardshell-roof-top-tent-2-sizes?_pos=1&_sid=bc02342b9&_ss=r&variant=19553635860537> [site visited Jun. 14, 2022] (Year: 2019).*

(Continued)

Primary Examiner — Joseph Kukella

Assistant Examiner — Yuan Yuan

(74) *Attorney, Agent, or Firm* — Muncy, Geissler, Olds & Lowe, P.C.

(57) **CLAIM**

The ornamental design for a tent, as shown and described.

DESCRIPTION

FIG. 1 is a front elevational view of a tent showing our new design;
FIG. 2 is a rear elevational view thereof;
FIG. 3 is a left side view thereof;
FIG. 4 is a right side view thereof;
FIG. 5 is a top plan view thereof;
FIG. 6 is a bottom plan view thereof;
FIG. 7 is a perspective view thereof; and,
FIG. 8 is another perspective view thereof.
The broken lines illustrate portions of the tent which form no part of the claimed design.

1 Claim, 8 Drawing Sheets

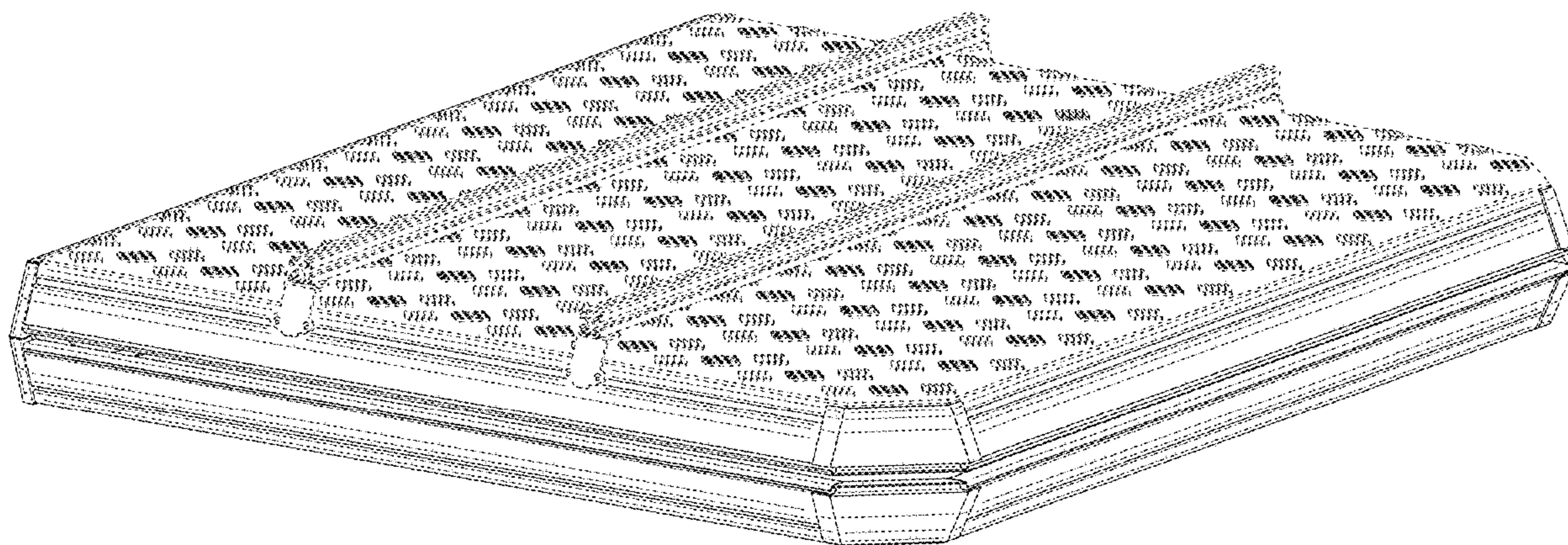

(58) **Field of Classification Search**
 CPC .. Y10S 135/901; A63H 33/008; A47D 13/063
 See application file for complete search history.

(56) **References Cited**

U.S. PATENT DOCUMENTS

5,544,671	A *	8/1996	Phillips	B60P 3/341
					135/88.14
D484,736	S *	1/2004	Sarnoff	D7/323
9,156,391	B2 *	10/2015	Loranger	B60P 3/341
9,222,278	B2 *	12/2015	Park	E04H 15/06
D820,192	S *	6/2018	Currid	D12/403
10,465,412	B1 *	11/2019	Currid	E04H 15/008
10,590,675	B2 *	3/2020	Zhou	E04H 15/008
11,105,112	B2 *	8/2021	Montesalvo	E04H 15/54
D936,521	S *	11/2021	Zhang	D12/103
D943,045	S *	2/2022	Park	D21/834
11,345,272	B1 *	5/2022	Tatro	B60R 9/04
2003/0136064	A1 *	7/2003	Von Arx	G09F 15/0025
					52/749.1
2021/0025190	A1 *	1/2021	Montesalvo	B60P 3/38
2022/0017008	A1 *	1/2022	Davis	B60P 3/38

OTHER PUBLICATIONS

The Vagabond Rooftop Tent. Earliest Review Date: Nov. 21, 2018.
 Retrieved from internet: <<https://www.roamadventureco.com/products/the-vagabond#shopify-product-reviews>> [site visited Jun. 14, 2022]
 (Year: 2018).*

Alu-Cab Gen 3.1 Expedition Tent Walkthrough. Date Uploaded:
 Feb. 2, 2021. Retrieved from internet: <<https://www.youtube.com/watch?v=-EP2vY-5mGI>> [site visited Jun. 14, 2022] (Year: 2021).*

* cited by examiner

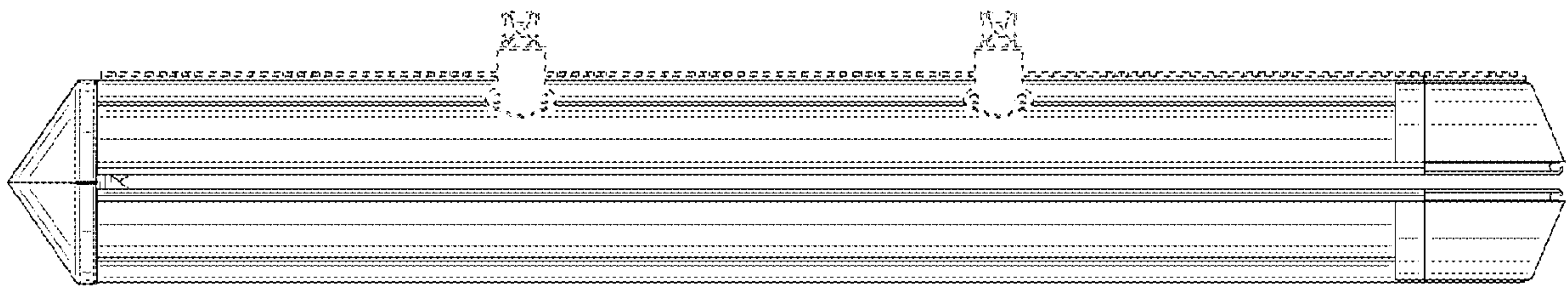

FIG. 1

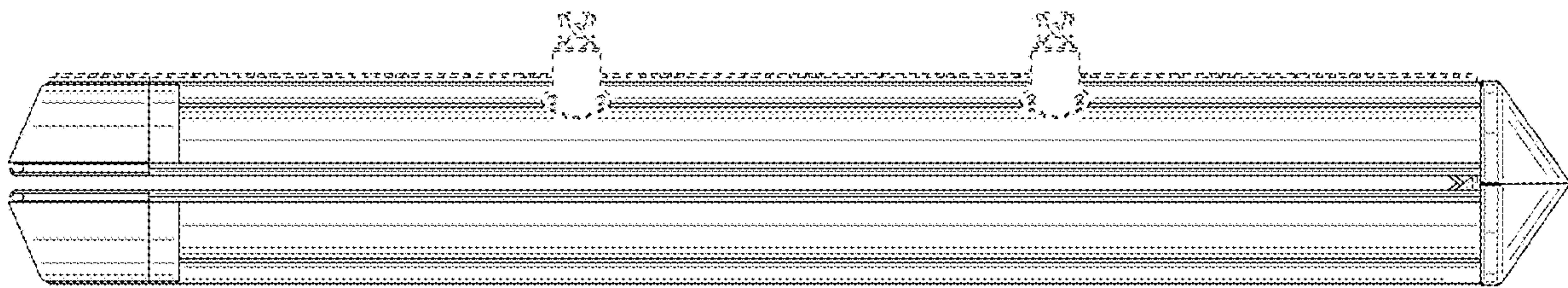

FIG. 2

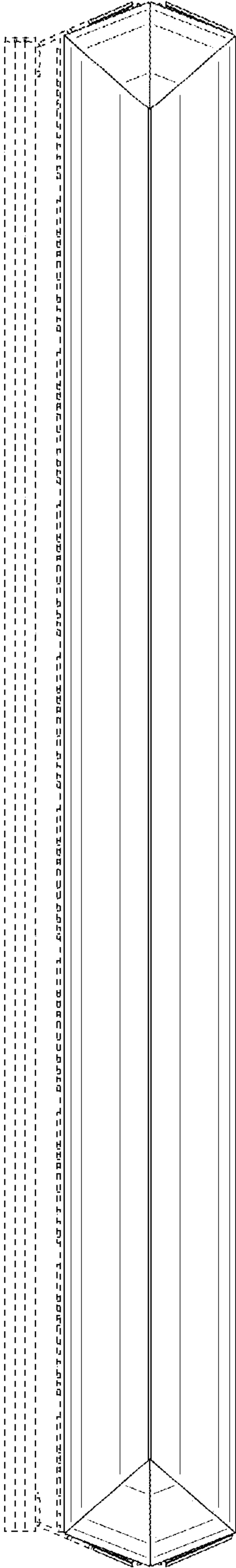

FIG. 3

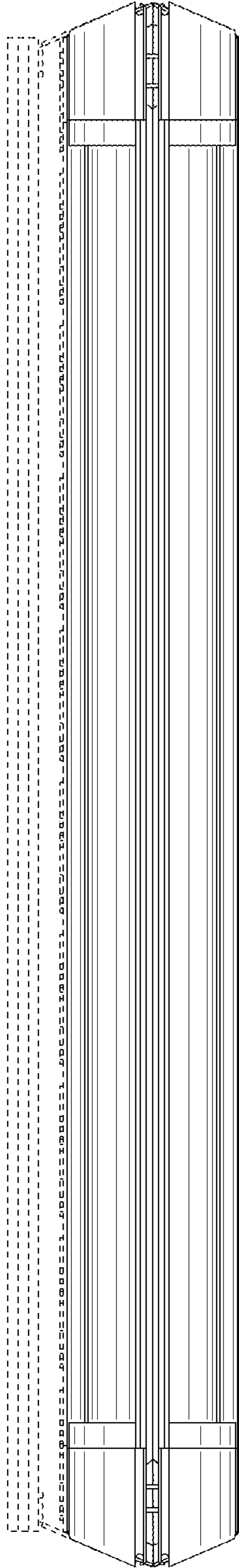

FIG. 4

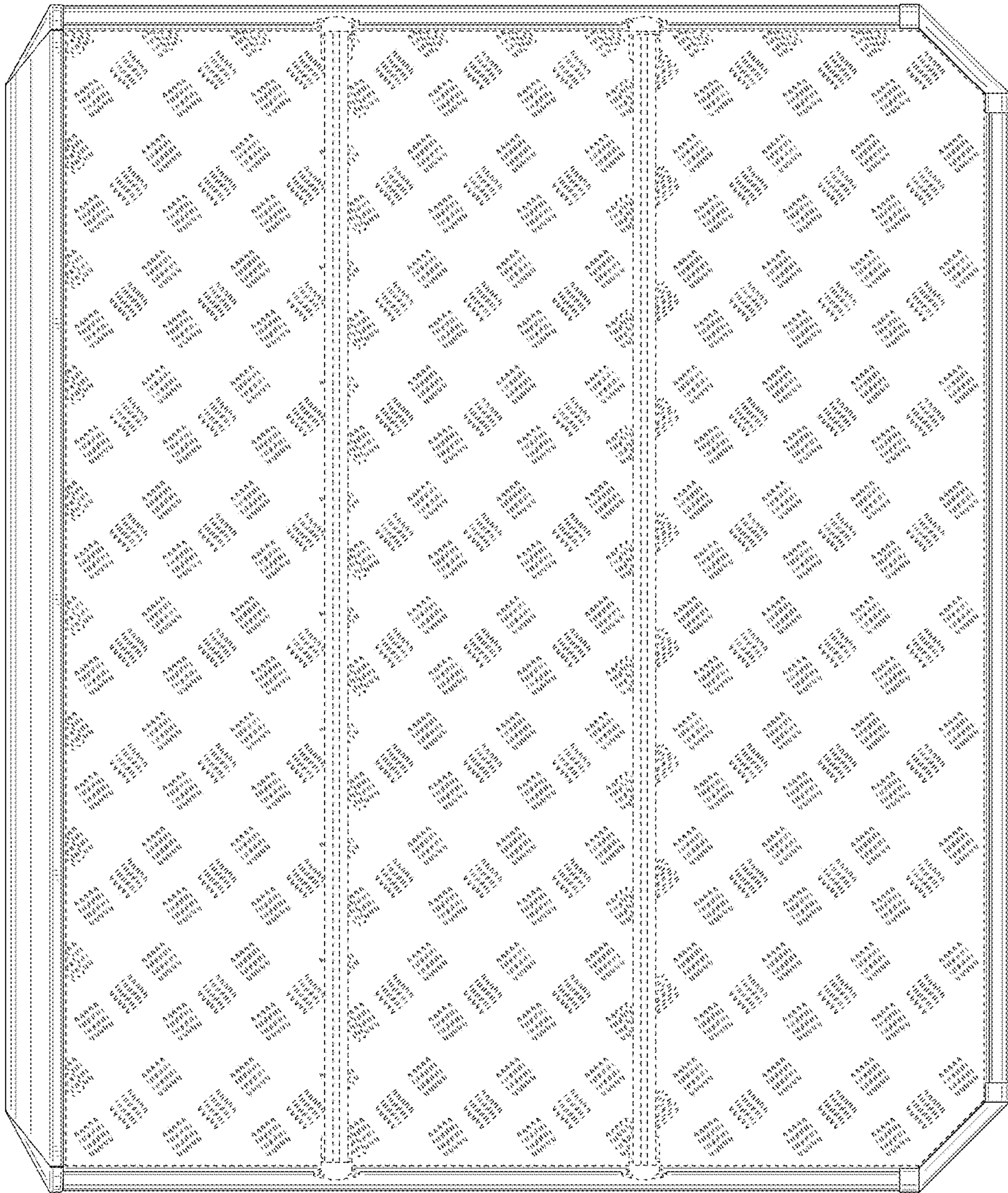

FIG. 5

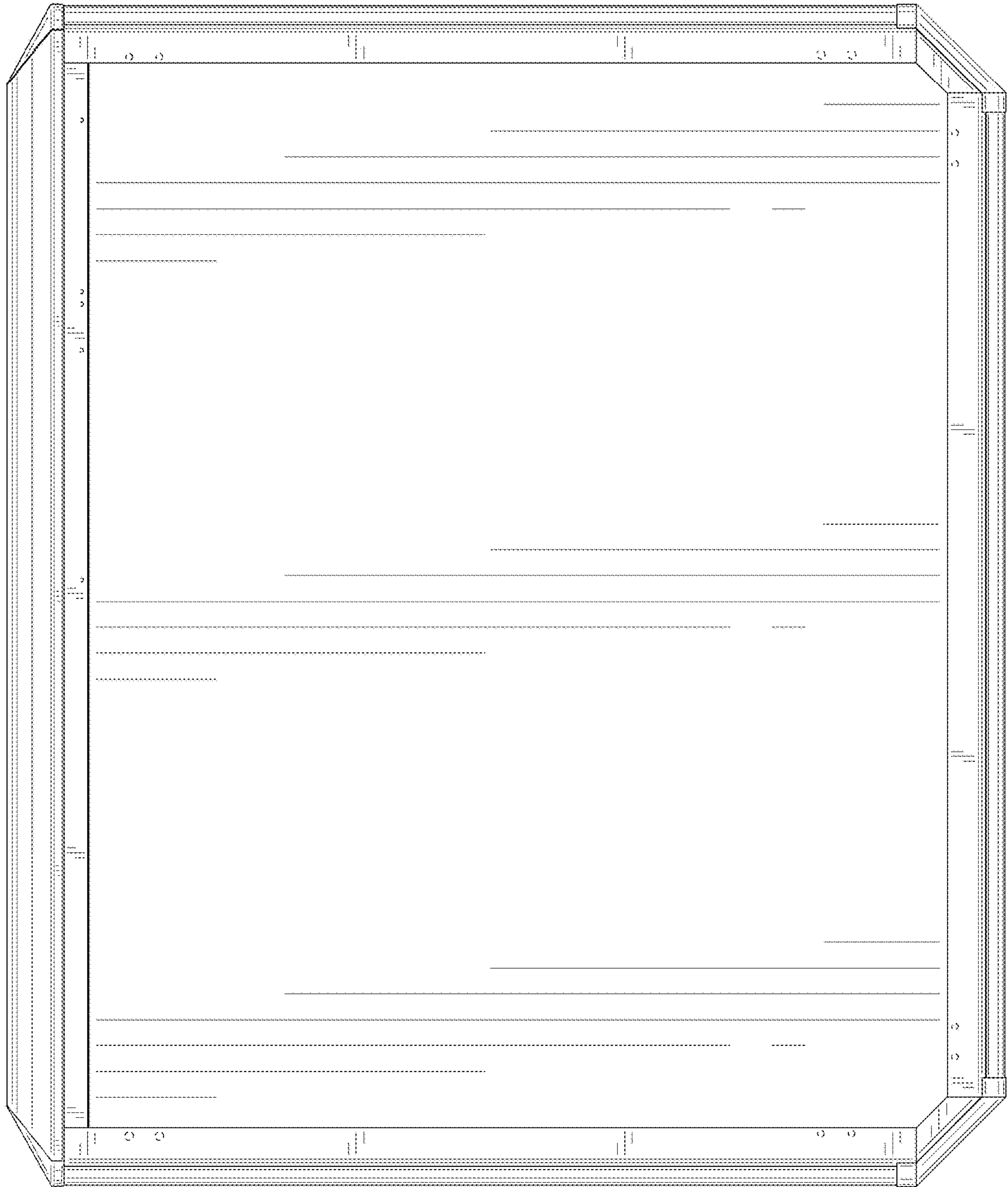

FIG. 6

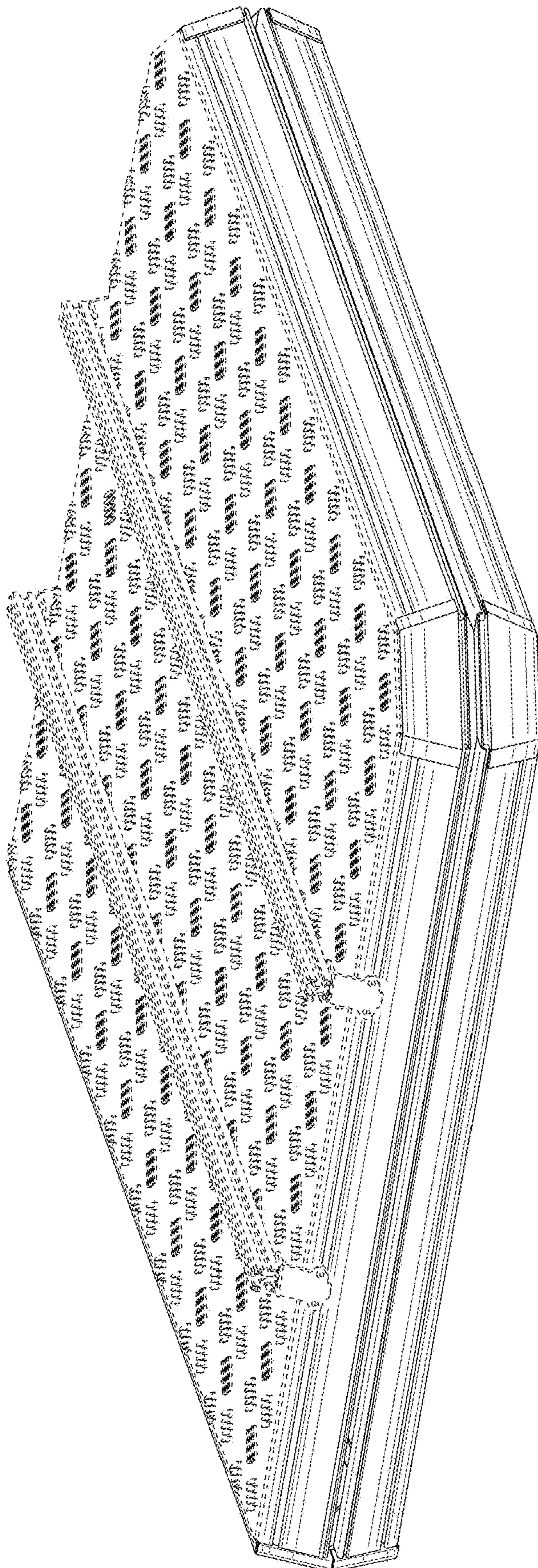

FIG. 7

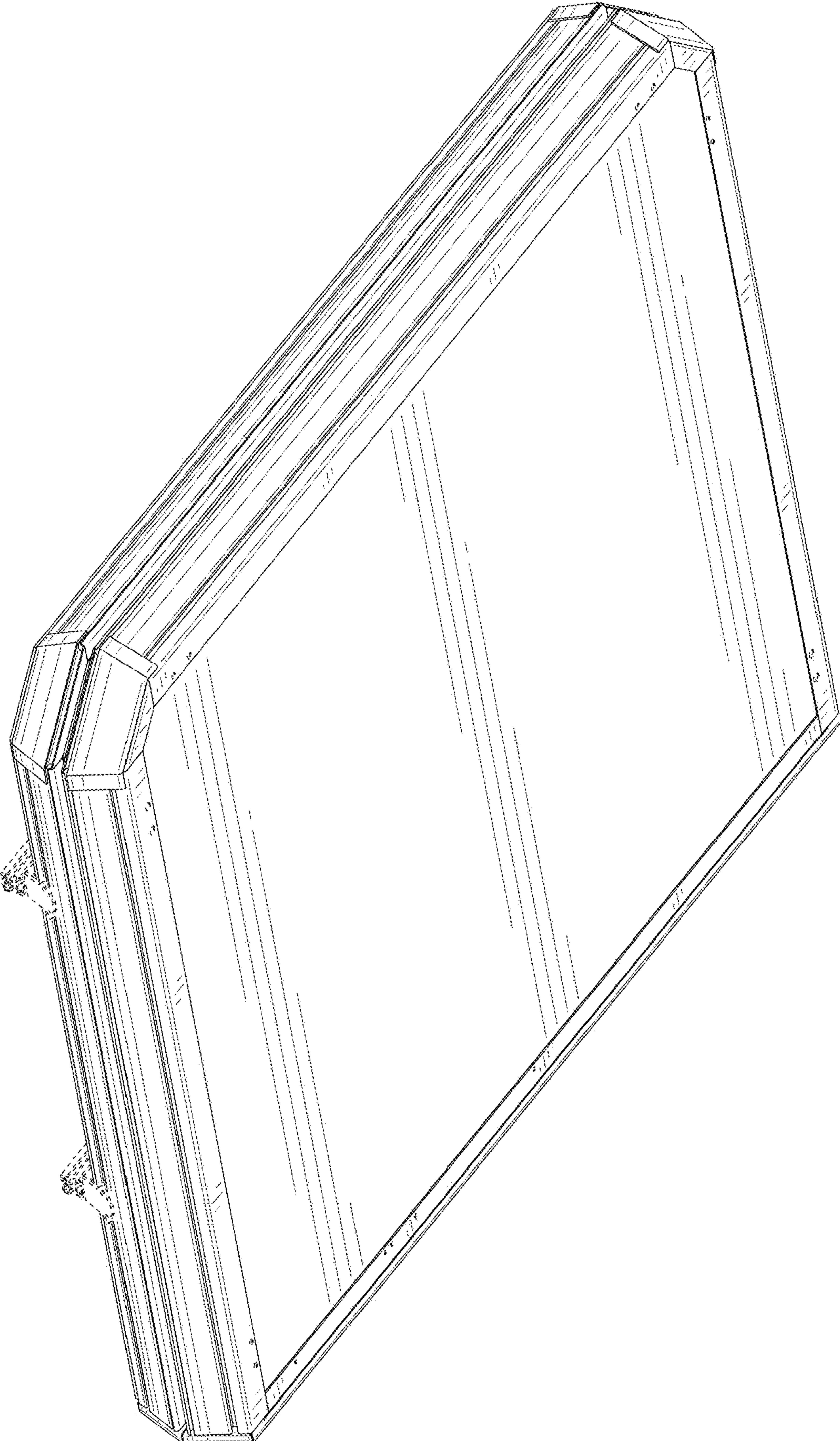

FIG. 8