



US00D964345S

(12) **United States Design Patent** (10) **Patent No.:** **US D964,345 S**  
**Park** (45) **Date of Patent:** **\*\* Sep. 20, 2022**

(54) **ALL-IN-ONE COMPUTER**

(71) Applicant: **Lenovo (Beijing) Co., Ltd.**, Beijing (CN)

(72) Inventor: **Sangwoo Park**, Beijing (CN)

(73) Assignee: **Lenovo (Beijing) Co., Ltd.**, Beijing (CN)

(\*\*) Term: **15 Years**

(21) Appl. No.: **29/788,258**

(22) Filed: **Apr. 20, 2021**

**Related U.S. Application Data**

(62) Division of application No. 29/626,047, filed on Nov. 14, 2017, now Pat. No. Des. 919,613.

(30) **Foreign Application Priority Data**

Jul. 18, 2017 (CN) ..... 201730317707.X

(51) **LOC (13) Cl.** ..... **14-02**

(52) **U.S. Cl.**  
USPC ..... **D14/314; D14/349; D14/496**

(58) **Field of Classification Search**  
USPC ..... D14/125–130, 135, 137, 140, 140.11, D14/142, 144, 147, 149, 150, 155, 168, D14/172, 185, 188, 203.1, 203.3, 204, D14/206, 209.1, 212–217, 218, 221, 226, D14/240, 242, 248, 257, 299, 301, 308,  
(Continued)

(56) **References Cited**

**U.S. PATENT DOCUMENTS**

D230,511 S † 2/1974 Stieber ..... D99/28  
D349,432 S † 8/1994 Kibbe ..... D26/38

(Continued)

**OTHER PUBLICATIONS**

Notice of Restriction Requirement of the U.S. Appl. No. 29/626,047, dated Feb. 20, 2020.

(Continued)

*Primary Examiner* — Rebekah A Caruso

(74) *Attorney, Agent, or Firm* — Oppedahl Patent Law Firm LLC

(57) **CLAIM**

The ornamental design for an all-in-one computer, as shown and described.

**DESCRIPTION**

FIG. 1 is a front view of an all-in-one computer showing the new design in a first embodiment;  
FIG. 2 is a back view thereof;  
FIG. 3 is a left side view thereof;  
FIG. 4 is a right side view thereof;  
FIG. 5 is a top view thereof;  
FIG. 6 is a bottom view thereof;  
FIG. 7 is a perspective view thereof;  
FIG. 8 is a perspective view thereof showing two parts of the all-in-one computer separated;  
FIG. 9 is a front view of an all-in-one computer showing the new design in a second embodiment;  
FIG. 10 is a back view thereof;  
FIG. 11 is a left side view thereof;  
FIG. 12 is a right side view thereof;  
FIG. 13 is a top view thereof;  
FIG. 14 is a bottom view thereof;  
FIG. 15 is a perspective view thereof; and,  
FIG. 16 is a perspective view thereof showing two parts of the all-in-one computer separated.  
The broken lines shown in the drawings illustrate portions of the all-in-one computer that form no part of the claimed design.

**1 Claim, 16 Drawing Sheets**

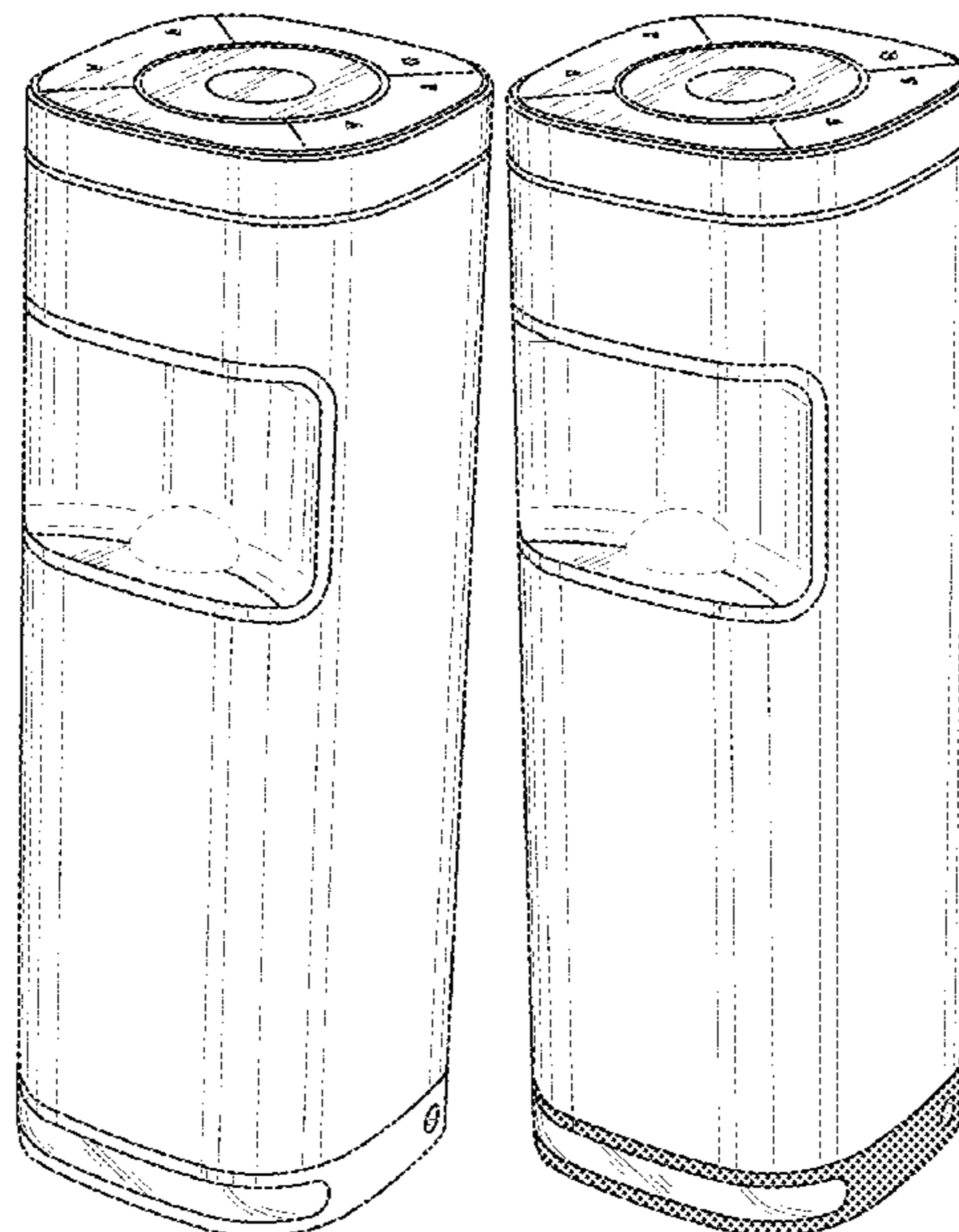

(58) **Field of Classification Search**

USPC ..... D14/314, 341, 348, 349, 353, 354, 356,  
 D14/357, 358, 432, 439, 447, 454, 496;  
 D13/110, 168, 184; D16/202, 203, 208;  
 D10/104.1, 106.1, 106.3  
 CPC ..... G06F 1/16; G06F 1/1601; G06F 1/1613;  
 G06F 1/1633; G06F 1/1637; G06F 3/167;  
 G06F 15/0216; H04N 7/14; H04N 7/142;  
 H04N 7/147; H04N 7/15; H04N 21/00;  
 H04N 21/20; H04N 21/40; H04R 1/00;  
 H04R 1/02; H04R 1/403; H04R 1/406;  
 H04R 27/00

See application file for complete search history.

(56) **References Cited**

U.S. PATENT DOCUMENTS

D392,624 S † 3/1998 Hower ..... D10/104.1  
 D409,740 S † 5/1999 Gallagher ..... D23/366  
 D441,729 S † 5/2001 Fujikura ..... D13/158  
 D504,409 S † 4/2005 Kim ..... D14/203.3  
 D515,838 S † 2/2006 Cravens ..... D14/129  
 D518,080 S † 3/2006 Uehara ..... D16/202  
 D528,510 S † 9/2006 Schmieta ..... D13/168  
 D532,426 S † 11/2006 Lee ..... D14/203.3  
 D538,914 S † 3/2007 Nelson ..... D23/366  
 D546,347 S † 7/2007 Millora ..... D14/496  
 D565,080 S † 3/2008 Ishikawa ..... D16/221  
 D615,556 S † 5/2010 Yeo ..... D14/203.3  
 D640,362 S † 6/2011 Boshuizen ..... D23/366  
 D674,778 S † 1/2013 Skurdal ..... D14/214  
 D691,255 S † 10/2013 Abbondanzio ..... D23/366  
 D718,335 S † 11/2014 Lee ..... D14/203.1  
 D731,575 S † 6/2015 Moss ..... D16/215

D737,788 S † 9/2015 Leung ..... D14/125  
 D753,644 S † 4/2016 Hsieh ..... D14/314  
 D755,155 S † 5/2016 Paterson ..... D14/204  
 D804,460 S † 12/2017 Li ..... D14/242  
 D813,213 S † 3/2018 Honda ..... D14/240  
 D820,334 S † 6/2018 Lee ..... D15/199  
 D825,365 S † 8/2018 Van Der Bijl ..... D10/104.1  
 D837,182 S † 1/2019 Elmieh ..... D14/204  
 D853,361 S † 7/2019 Ding ..... D14/225  
 D854,509 S † 7/2019 Wu ..... D14/168  
 D858,613 S † 9/2019 Cho ..... D16/221  
 D864,890 S † 10/2019 Henning ..... D14/172  
 D868,726 S † 12/2019 Kim ..... D14/204  
 10,509,437 B2 † 12/2019 Patterson ..... G06F 3/167  
 D873,242 S † 1/2020 Kosaka ..... D14/214  
 D874,423 S † 2/2020 Wu ..... D14/168  
 D875,158 S † 2/2020 Wang ..... D16/203  
 D875,159 S † 2/2020 Siminoff ..... D16/203  
 D886,788 S † 6/2020 Wang ..... D14/204  
 D886,883 S † 6/2020 Zhang ..... D16/203  
 D897,315 S † 9/2020 Hong ..... D14/218  
 D905,008 S † 12/2020 Kim ..... D14/209.1  
 D919,613 S \* 5/2021 Park ..... D14/314  
 2005/0162545 A1 † 7/2005 Jeon ..... H04N 5/2252  
 348/373  
 2018/0242061 A1 † 8/2018 Honda ..... H04R 1/345

OTHER PUBLICATIONS

First Office Action of the U.S. Appl. No. 29/626,047, dated Jun. 24, 2020.

Notice of Allowance of the U.S. Appl. No. 29/626,047, dated Jan. 22, 2021.

\* cited by examiner

† imported from a related application

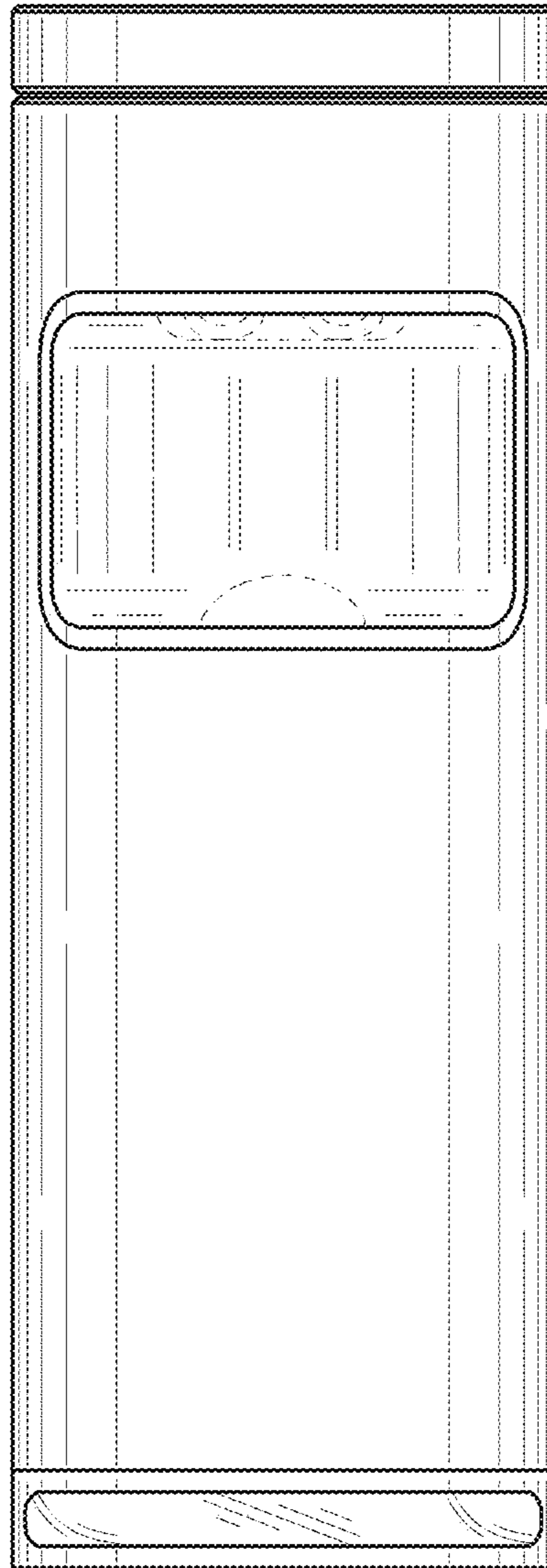

Fig. 1

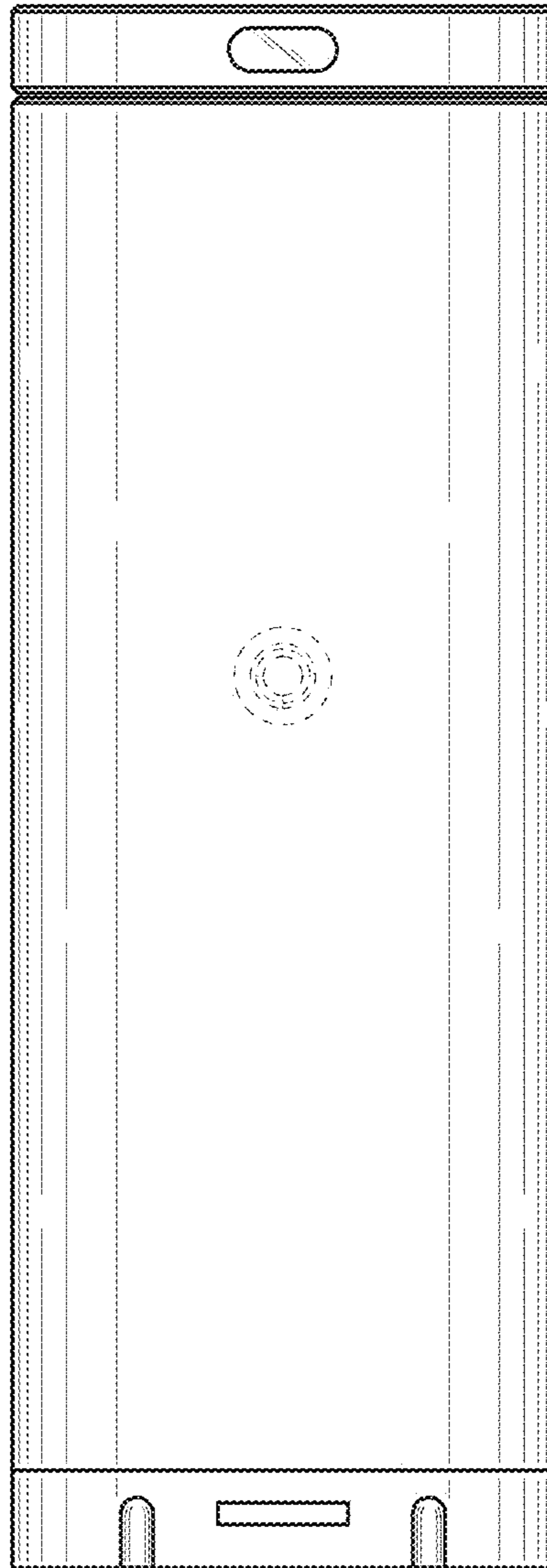

Fig. 2

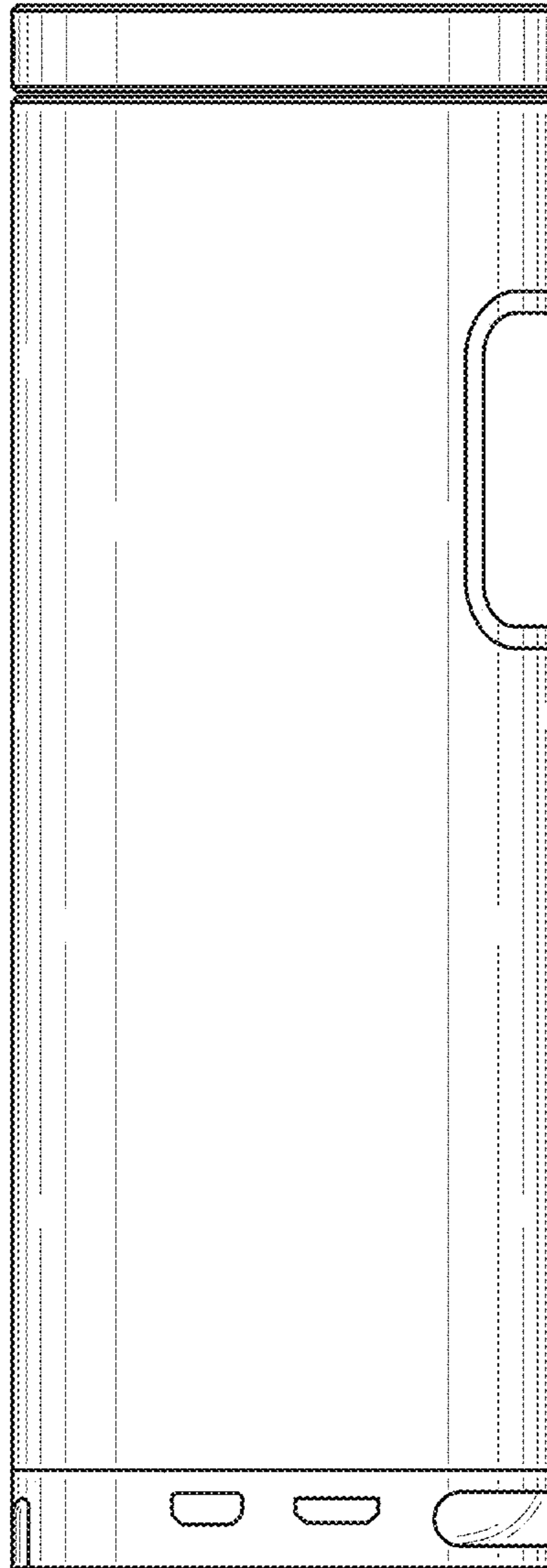

Fig. 3

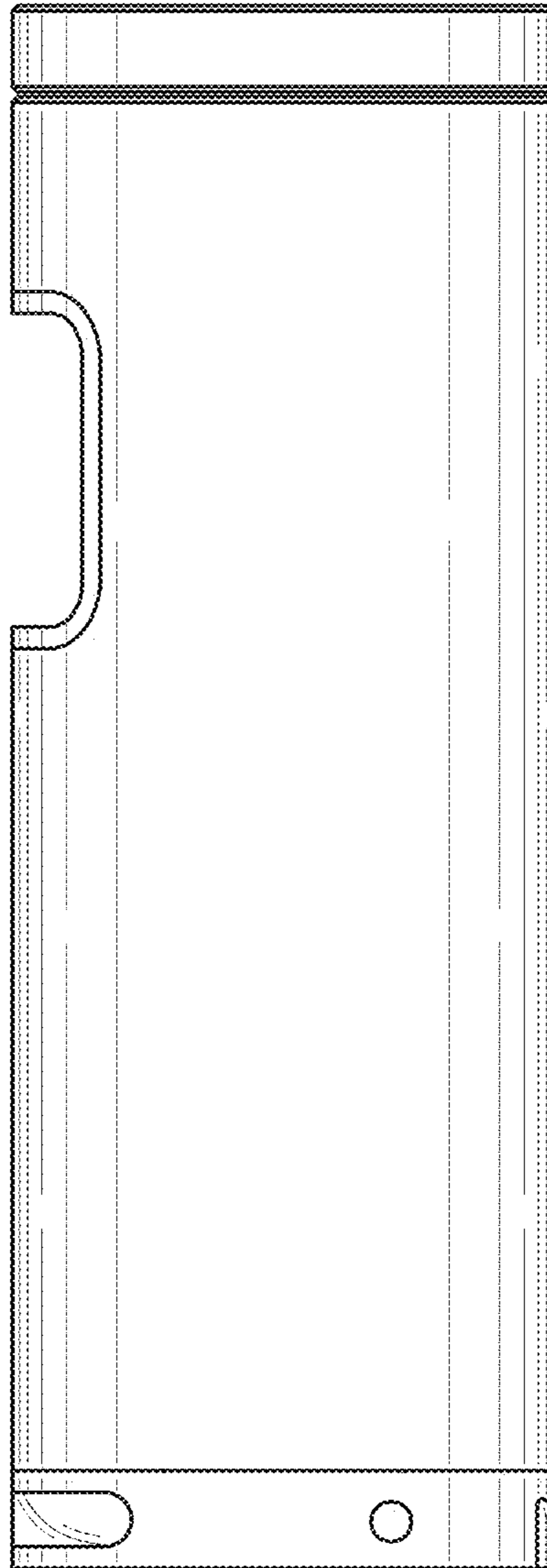

Fig. 4

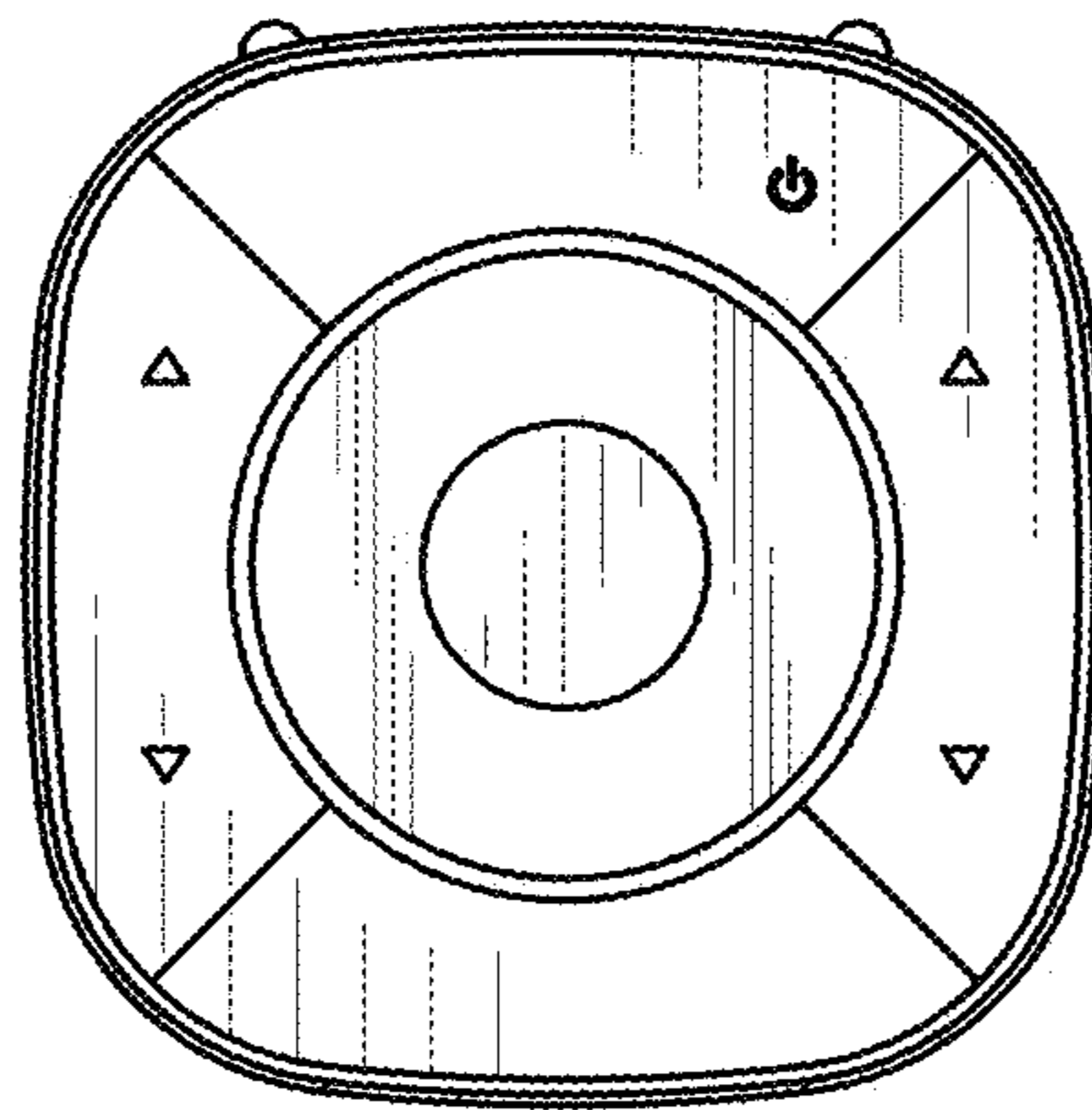

Fig. 5

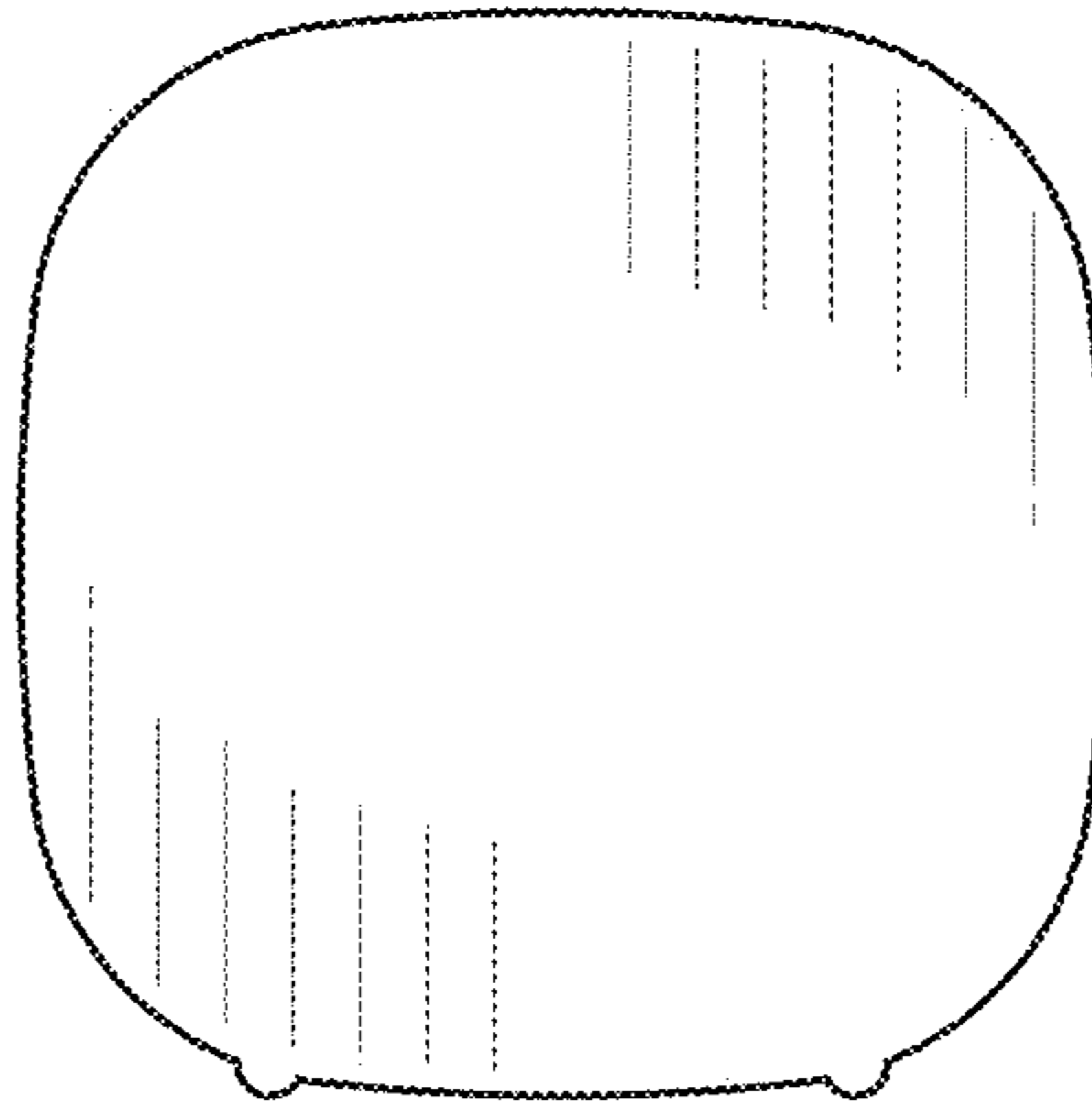

Fig. 6



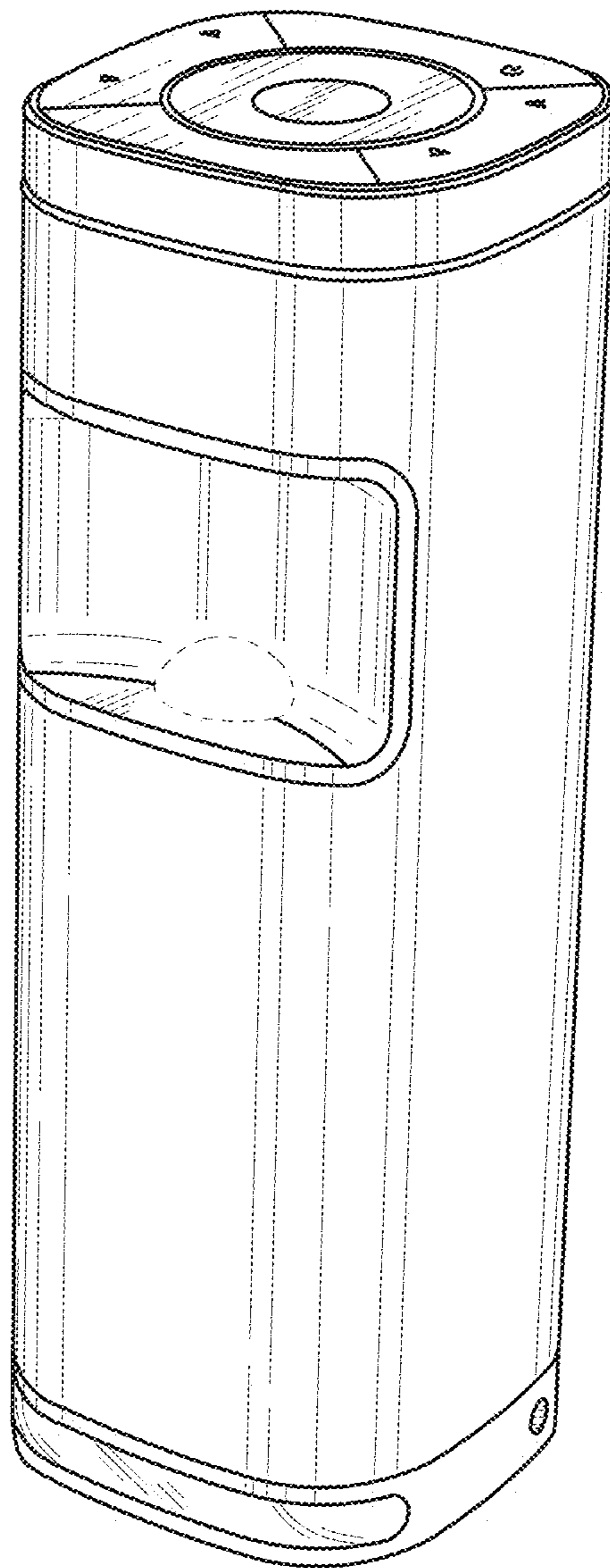

Fig. 7

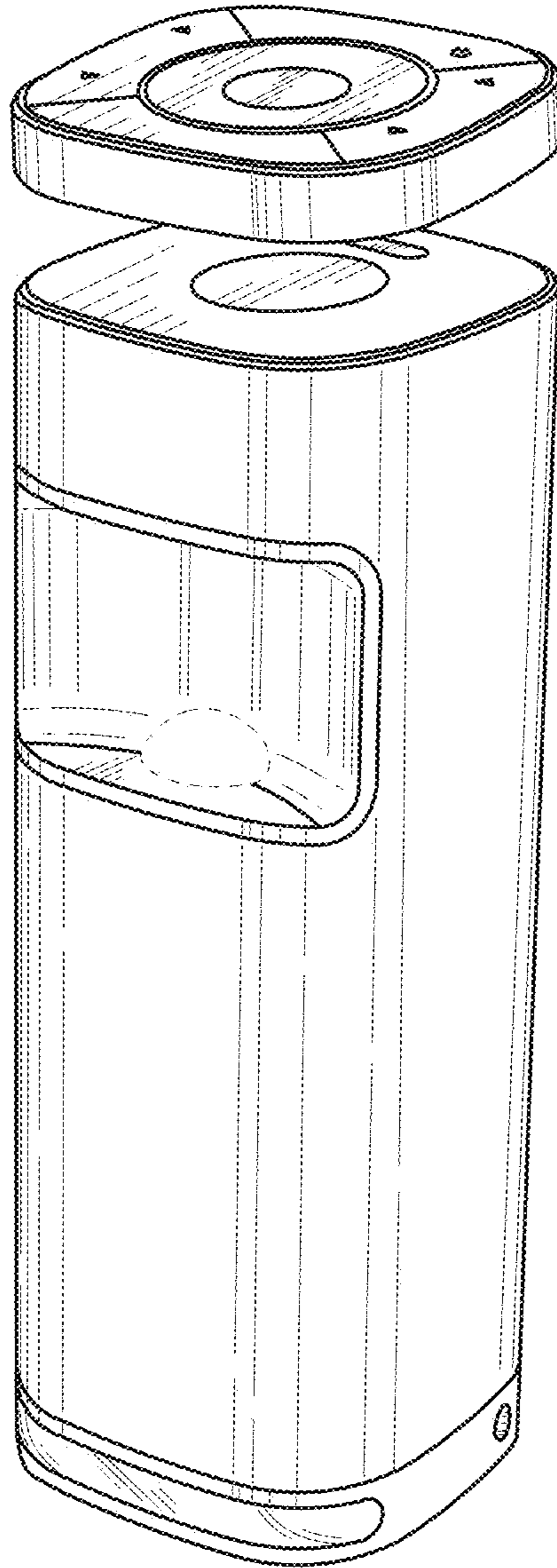

Fig. 8

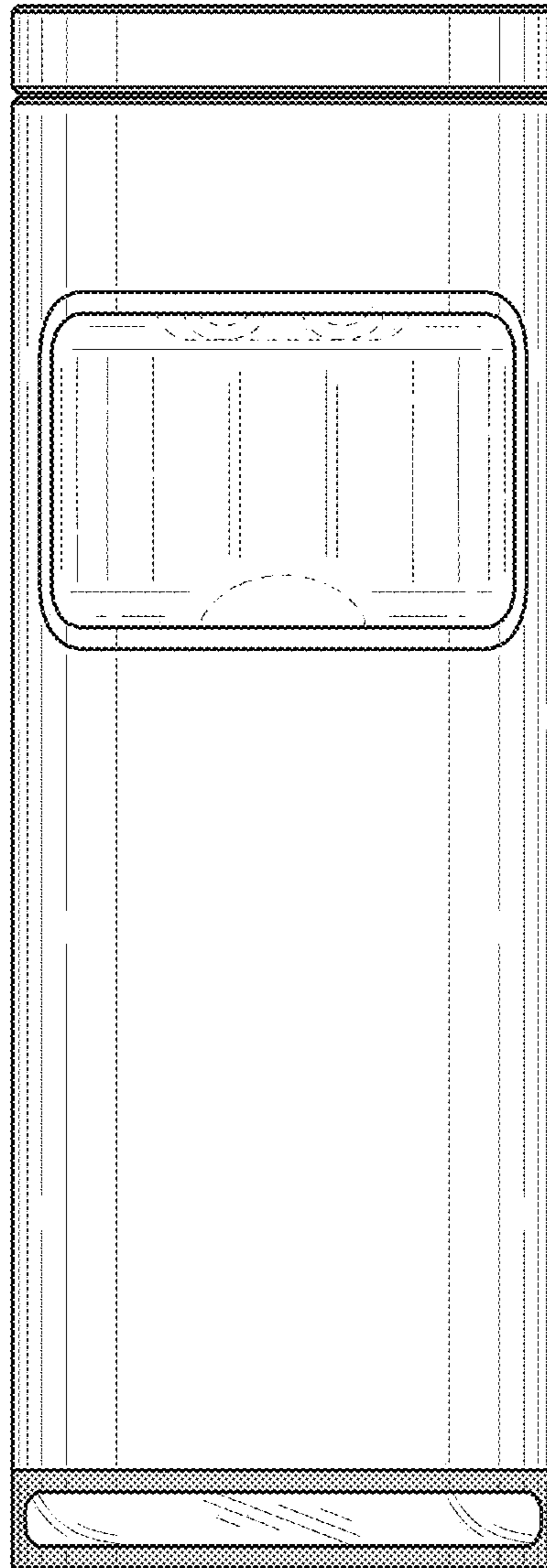

Fig. 9

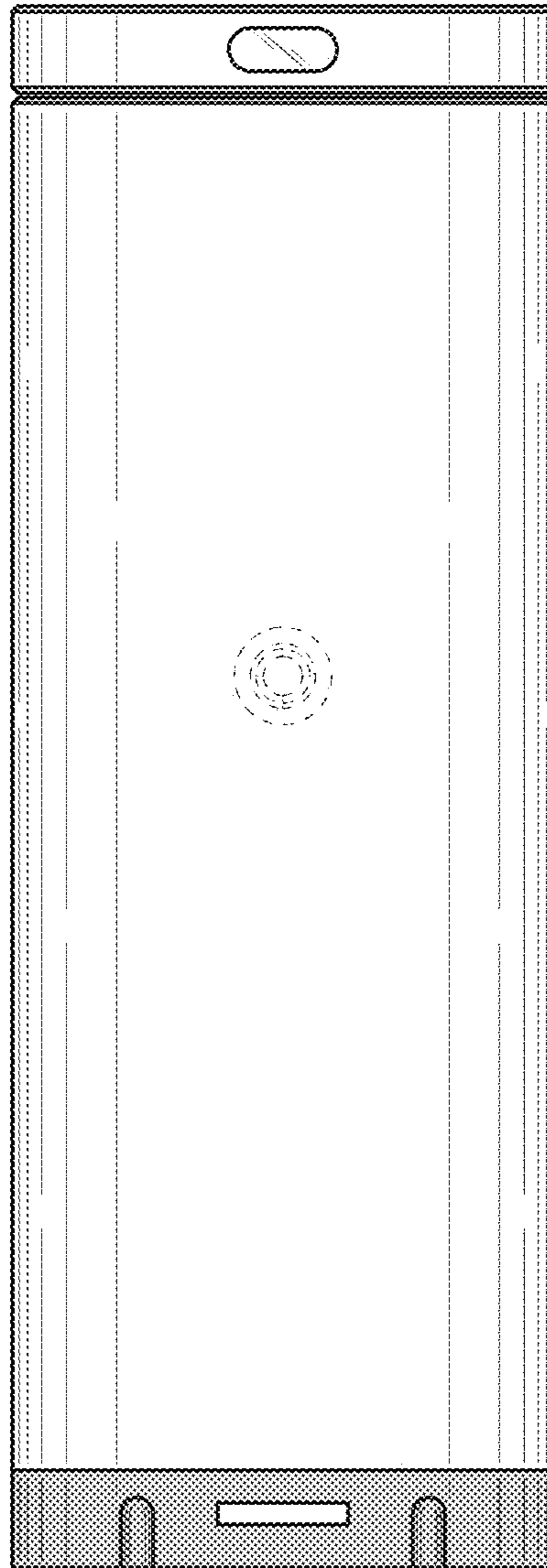

Fig. 10

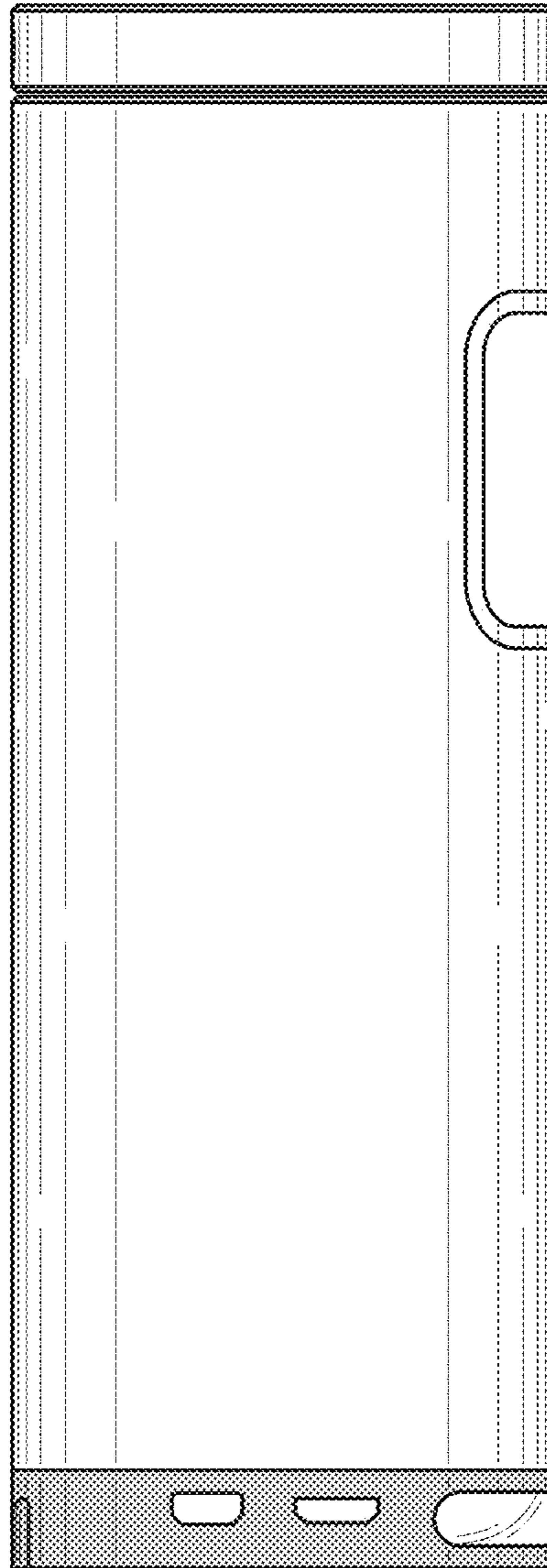

Fig. 11

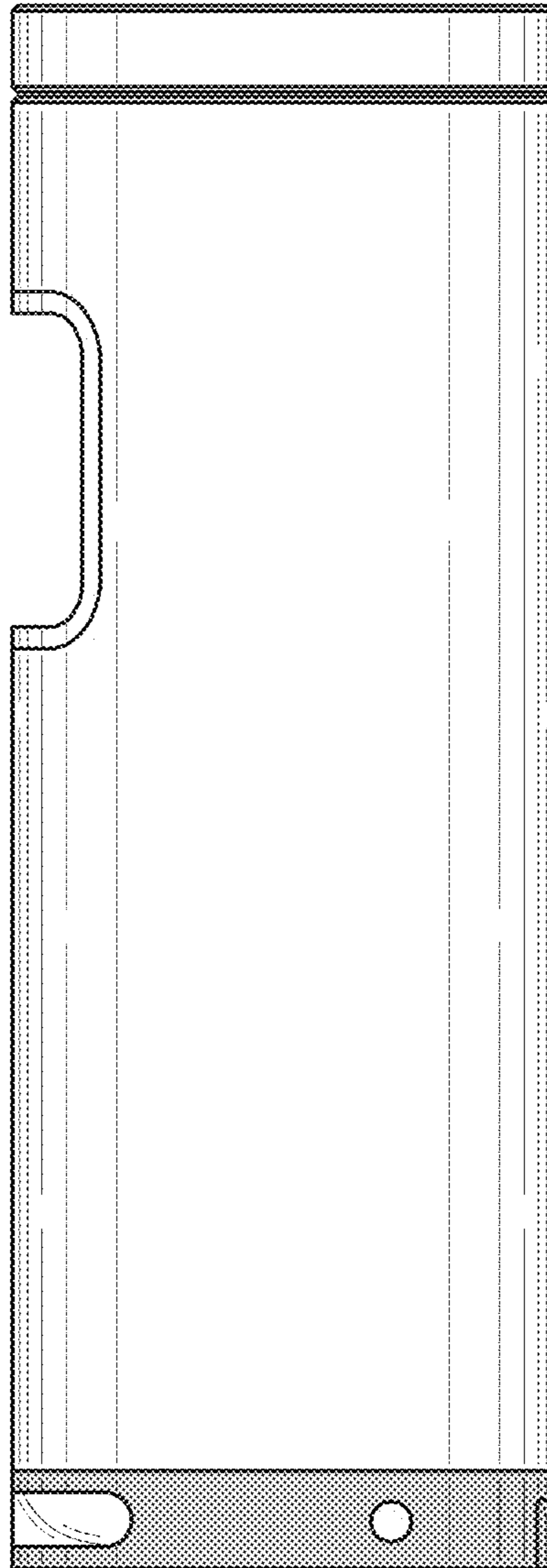

Fig. 12

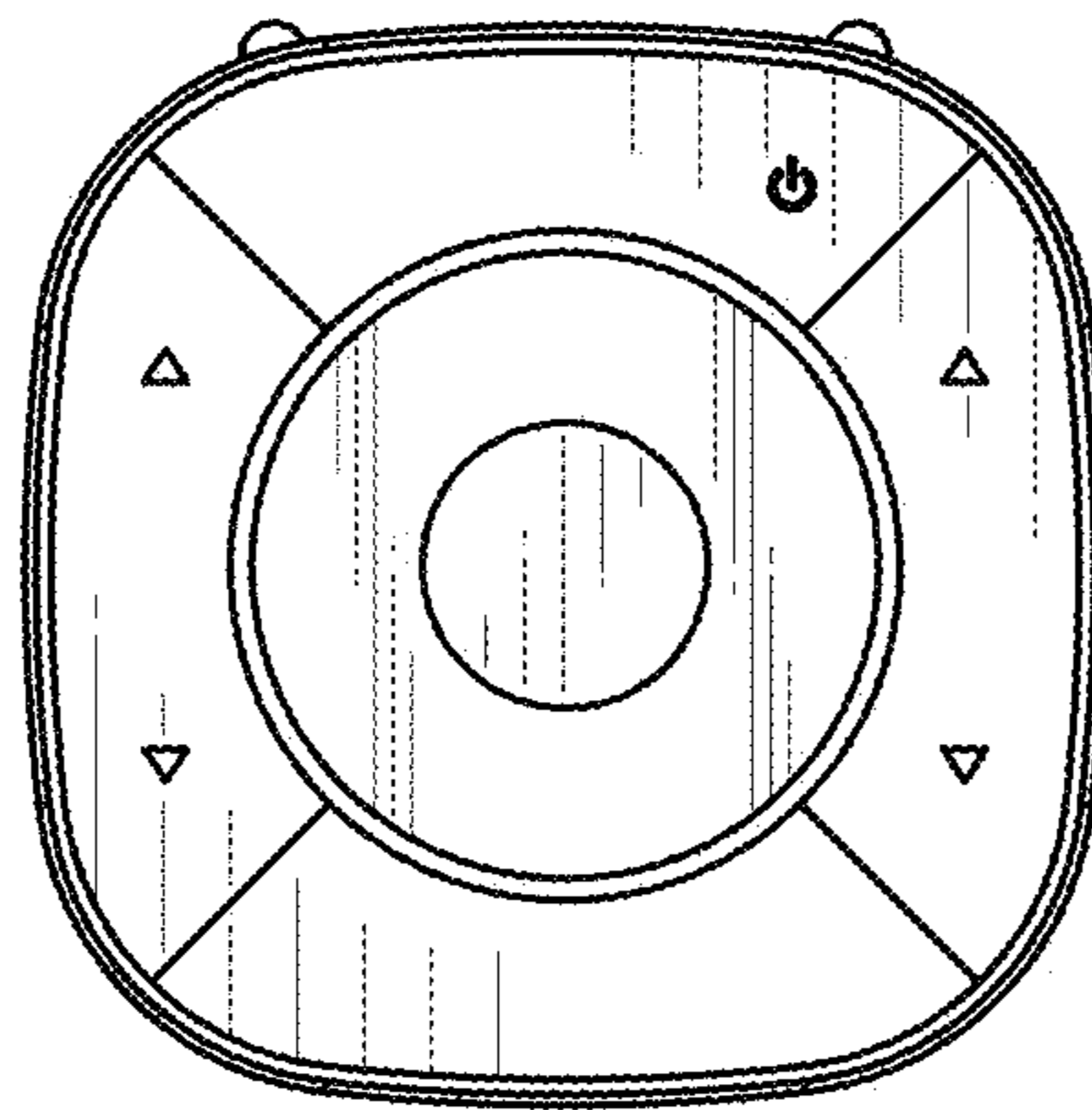

Fig. 13

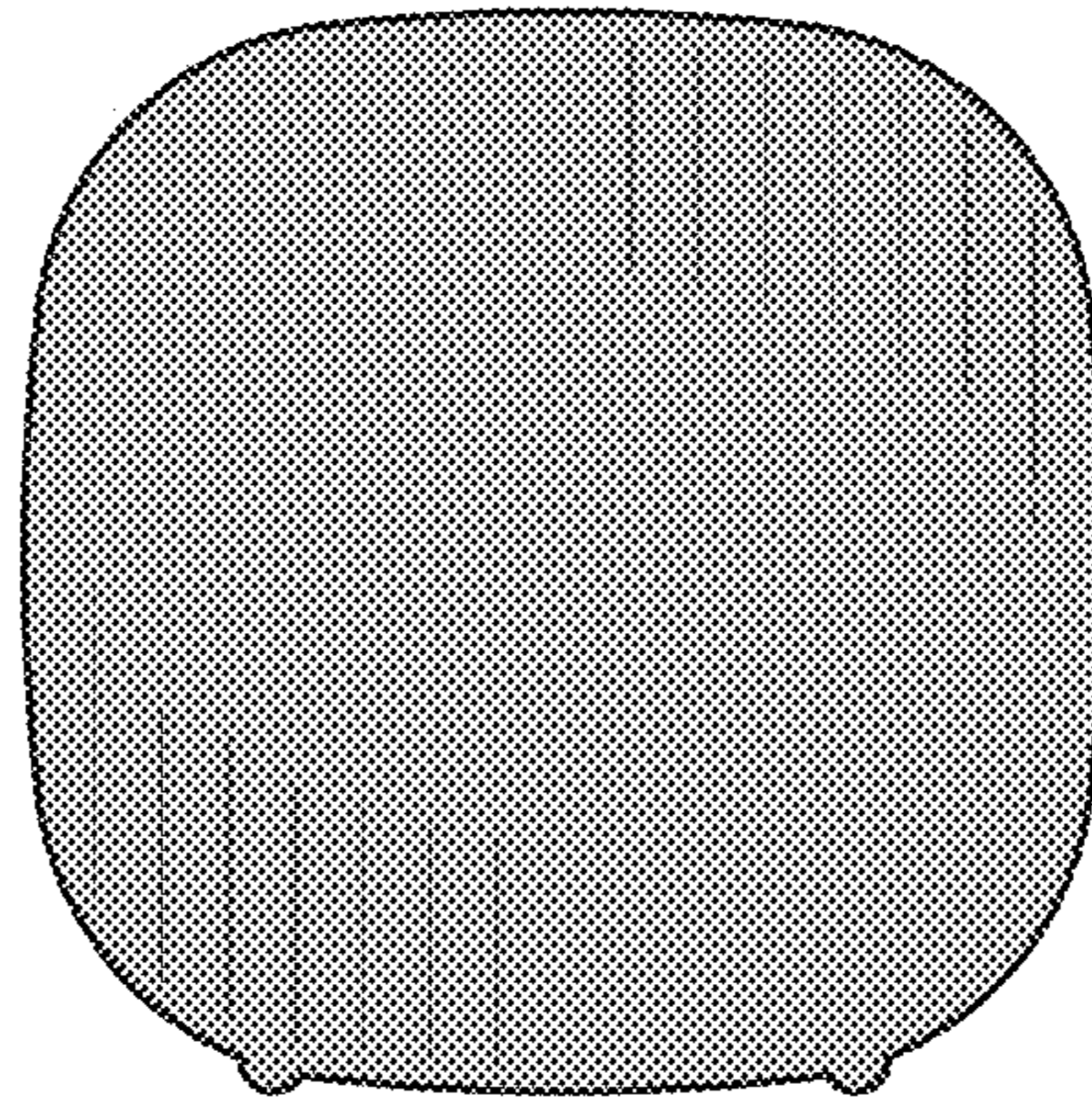

Fig. 14



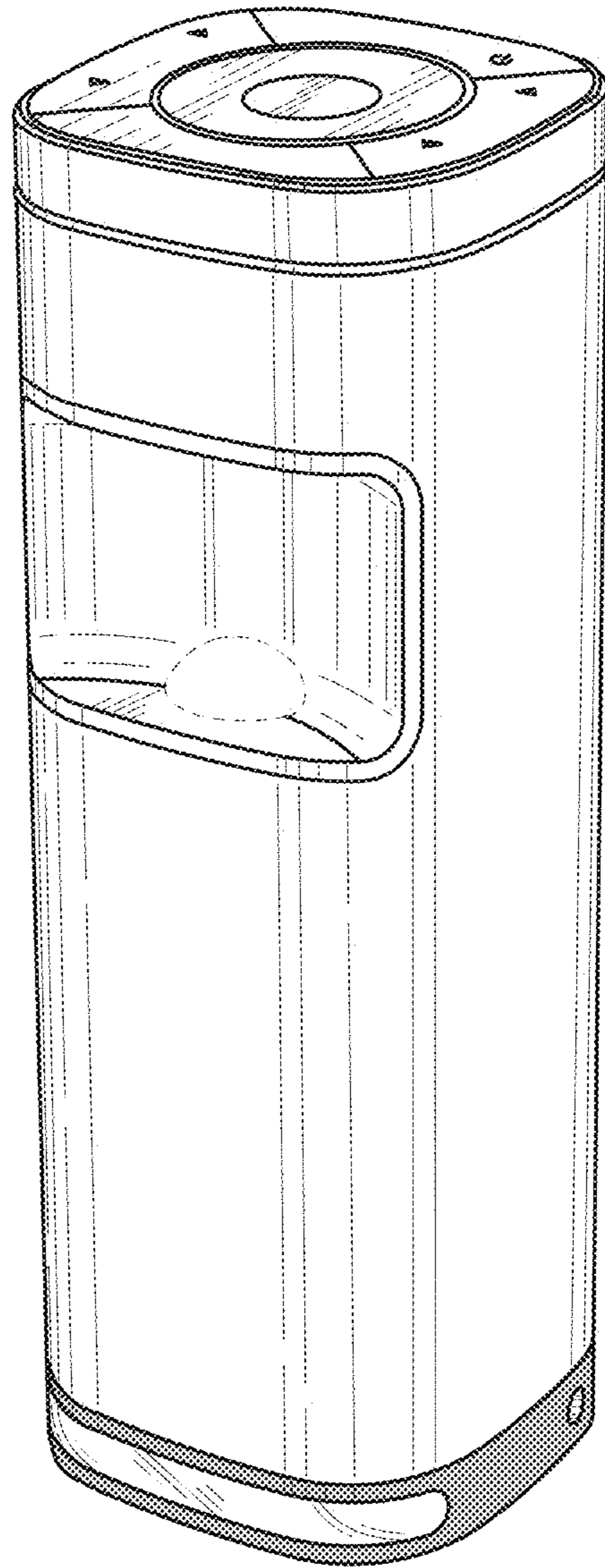

Fig. 15

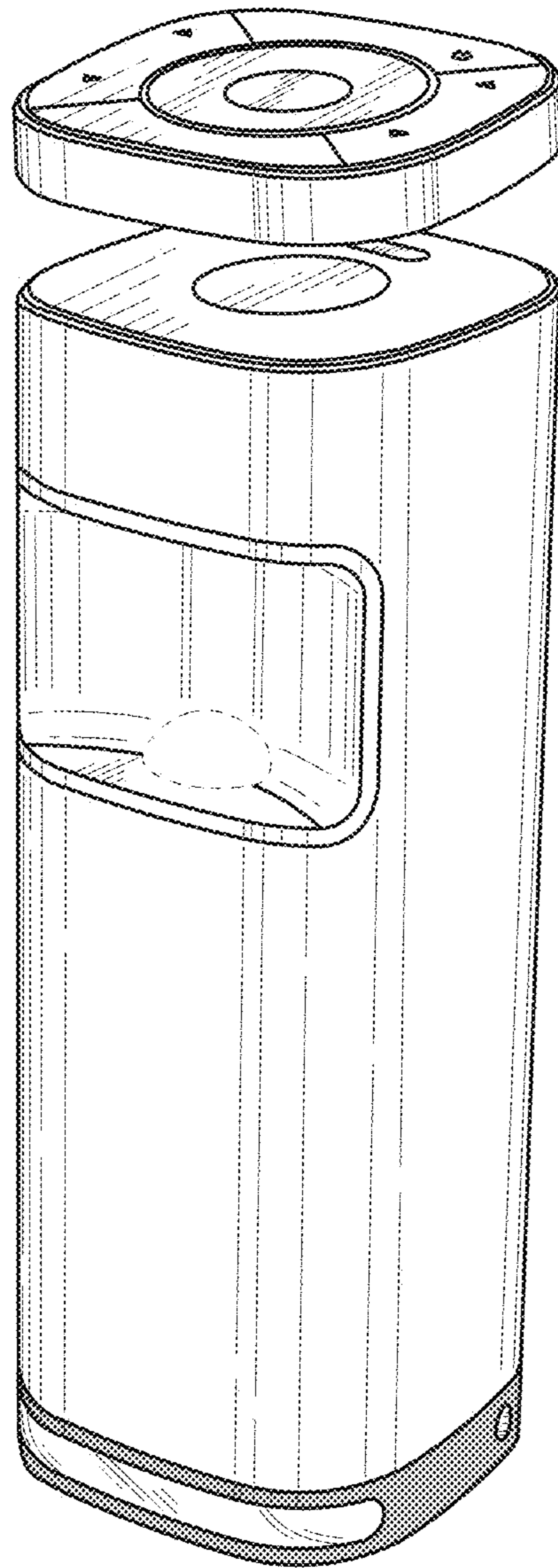

Fig. 16