



US00D964344S

(12) **United States Design Patent**  
**Fu et al.**

(10) **Patent No.:** **US D964,344 S**  
(45) **Date of Patent:** **\*\* Sep. 20, 2022**

(54) **SUPERCOMPUTING DEVICE**

(71) Applicant: **BITMAIN TECHNOLOGIES INC.**,  
Beijing (CN)

(72) Inventors: **Xingsong Fu**, Beijing (CN); **Xiangchao Liu**, Beijing (CN); **Lei Zhang**, Beijing (CN)

(73) Assignee: **BITMAIN TECHNOLOGIES INC.**,  
Beijing (CN)

(\*\*) Term: **15 Years**

(21) Appl. No.: **29/671,068**

(22) Filed: **Nov. 21, 2018**

(51) **LOC (13) Cl.** ..... **14-02**

(52) **U.S. Cl.**  
USPC ..... **D14/313**

(58) **Field of Classification Search**  
USPC ..... D14/300-304, 308-314, 328, 348-370,  
D14/388, 432, 435, 439-446, 450,  
D14/479-483, 140.1-140.4, 164, 193,  
D14/500-502, 257-258, 265; D13/184  
CPC ..... G06F 1/16; G06F 1/1628; G06F 1/181;  
H05K 7/00; H05K 7/18; H05K 7/14;  
H05K 5/00; H05K 5/0004; H05K 5/0008;  
H05K 5/0021; H05K 5/0213; H05K  
5/012; H05K 5/0234; H05K 5/0243  
See application file for complete search history.

(56) **References Cited**

**U.S. PATENT DOCUMENTS**

D377,478 S \* 1/1997 Geek ..... D14/308  
D396,690 S \* 8/1998 Fryers ..... D13/147  
D410,446 S \* 6/1999 Konshak ..... D14/367

(Continued)

**OTHER PUBLICATIONS**

Rosewill 4U Server Chassis/Server Case/Rackmount Case, posted at Amazon, posting date Aug. 23, 2012. Site visited May 13, 2021.

URL: <<https://www.amazon.com/Rosewill-Rackmount-Computer-Pre-Installed-RSV-L4500/dp/B0091IZ1ZG?th=1>> (Year: 2012).\*

(Continued)

*Primary Examiner* — Kathleen L Jones

(74) *Attorney, Agent, or Firm* — J.C. Patents

(57) **CLAIM**

The ornamental design for a supercomputing device, as shown and described.

**DESCRIPTION**

FIG. 1 is a front view of a supercomputing device; FIG. 2 is a rear view of the supercomputing device; FIG. 3 is a left view of the supercomputing device; FIG. 4 is a right view of the supercomputing device; FIG. 5 is a top view of the supercomputing device; FIG. 6 is a bottom view of the supercomputing device; FIG. 7 is a perspective view of the supercomputing device; FIGS. 8 to 17 are enlarged views of the encircled portions on FIG. 1; FIGS. 18 to 22 are enlarged views of the encircled portions on FIG. 2; FIGS. 23 to 29 are enlarged views of the encircled portions on FIG. 3; FIGS. 30 to 33 are enlarged views of the encircled portions on FIG. 5; FIGS. 34 to 41 are enlarged views of the encircled portions on FIG. 6; and, FIGS. 42 to 55 are enlarged views of the encircled portions on FIG. 7.

The evenly spaced broken lines depicting portions of the supercomputing device form no part of the claimed design. The line-dot-line broken lines that encircle portions of FIGS. 1-7 and that border the FIGS. 8-55 detail views indicate outer limits of enlarged areas of the figures and form no part of the claimed design.

**1 Claim, 55 Drawing Sheets**

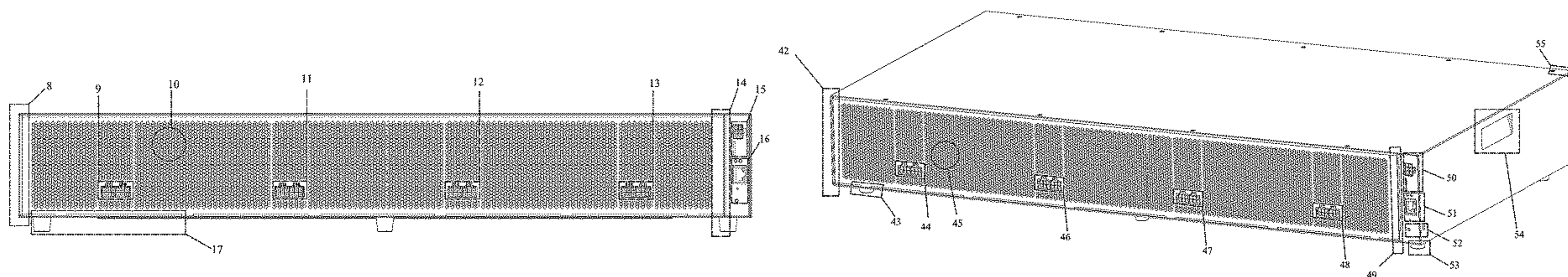

(56)

**References Cited**

U.S. PATENT DOCUMENTS

D427,191	S	*	6/2000	Hashizume	.....	D14/308
D464,054	S	*	10/2002	Houdek	.....	D14/444
D464,973	S	*	10/2002	Houdek	.....	D14/444
6,496,366	B1	*	12/2002	Coglitore	.....	G06F 1/18 174/377
D476,001	S	*	6/2003	Crisp	.....	D14/354
D477,826	S	*	7/2003	Crisp	.....	D14/444
D486,150	S	*	2/2004	Chung	.....	D14/356
D496,039	S	*	9/2004	Kerrigan	.....	D14/367
D521,466	S	*	5/2006	Nurmi	.....	D13/184
D699,718	S	*	2/2014	Kuehn	.....	D14/313
D735,186	S	*	7/2015	Terwilliger	.....	D14/313
D755,780	S	*	5/2016	Lin	.....	D14/301
D784,320	S	*	4/2017	Wallace	.....	D14/301
D785,616	S	*	5/2017	Zimmermann	.....	D14/313
D791,086	S	*	7/2017	Balschat	.....	D13/162.1
D795,244	S	*	8/2017	Zimmermann	.....	D14/313
D795,877	S	*	8/2017	Barron	.....	D14/439
D835,092	S	*	12/2018	Fu	.....	D14/301
D844,578	S	*	4/2019	Seflic	.....	D14/125
D857,014	S	*	8/2019	Wu	.....	D14/365
D895,561	S	*	9/2020	Xiang	.....	D13/184
D896,191	S	*	9/2020	Xiang	.....	D13/184
D896,218	S	*	9/2020	Gao	.....	D14/301

D896,807	S	*	9/2020	Li	.....	D14/313
D937,236	S	*	11/2021	Xiang	.....	D13/133
D949,850	S	*	4/2022	Tamayama	.....	D14/313
2012/0170208	A1	*	7/2012	Chen	.....	H05K 7/20736 361/679.48
2013/0091589	A1	*	4/2013	Shiakallis	.....	G06F 21/81 726/34
2015/0138716	A1	*	5/2015	Herman	.....	H05K 7/20145 361/679.32
2015/0138717	A1	*	5/2015	Herman	.....	H05K 7/1487 361/679.32
2016/0085276	A1	*	3/2016	Lieber	.....	H05K 7/16 361/679.31
2020/0214168	A1	*	7/2020	Bocek	.....	H05K 7/2089

OTHER PUBLICATIONS

Norco RPC-4224 4U Rackmount Server Case with 24 Hot-Swappable SATA/SAS Drive Bays, posted at newegg, posting date Dec. 28, 2011. Site visited May 13, 2021. URL: <<https://www.newegg.com/norco-rpc-4224/p/N82E16811219038>> (Year: 2011).\* "Terrablock New Version 1.5 by Facilis Technology" Japanese document No. HC17064844 published by Hoei Sangyo Co., Ltd., p. 15 cited in the Japanese Notice of Allowance.

\* cited by examiner



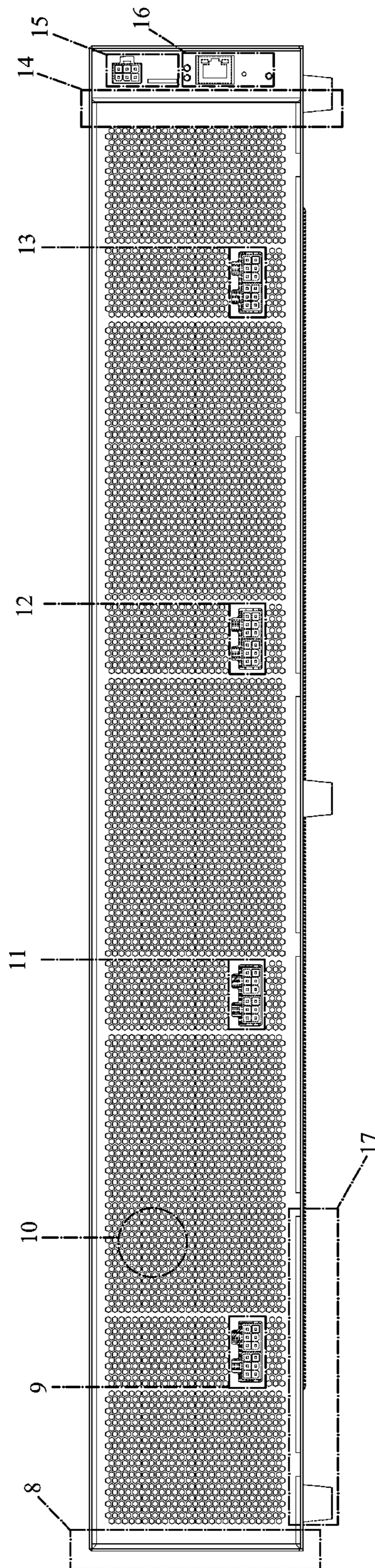

FIG. 1

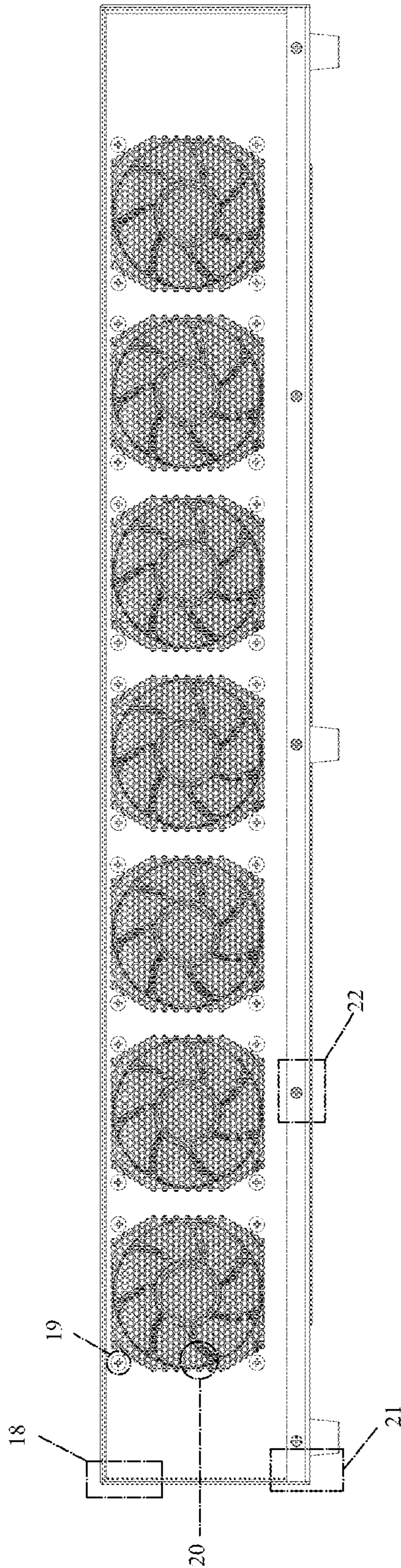

FIG. 2

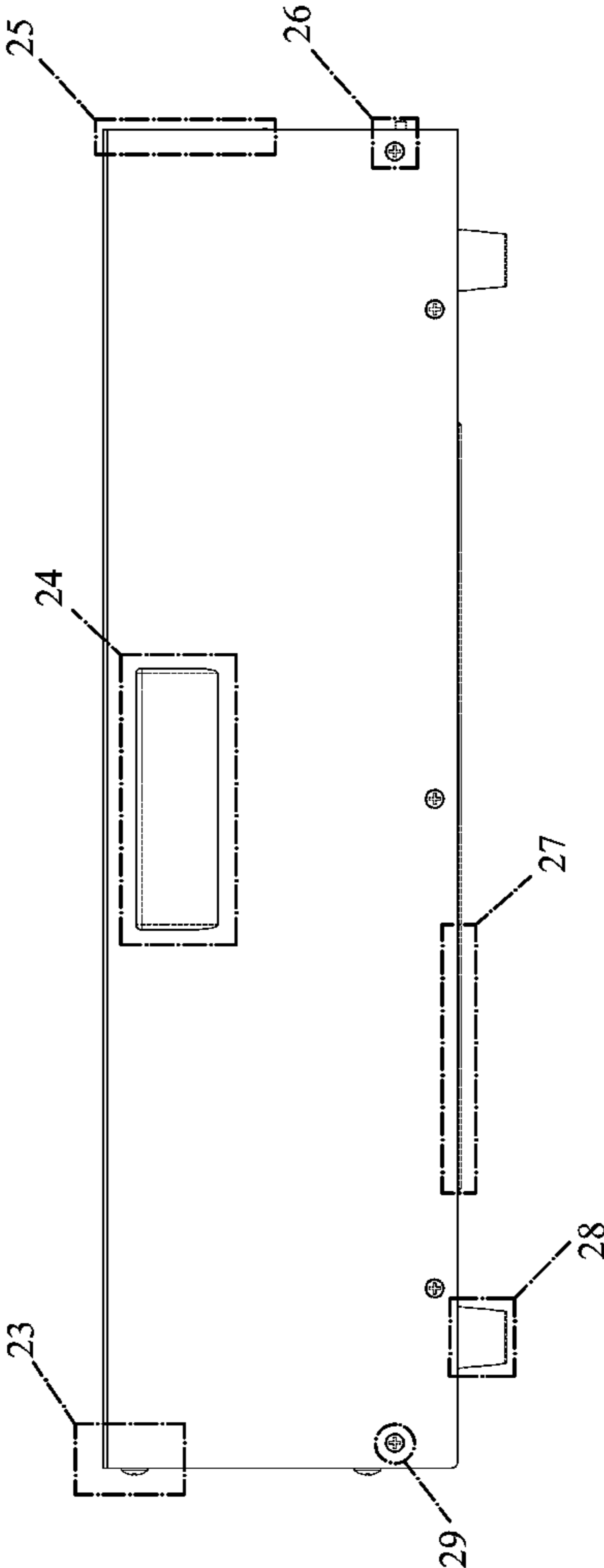

FIG. 3



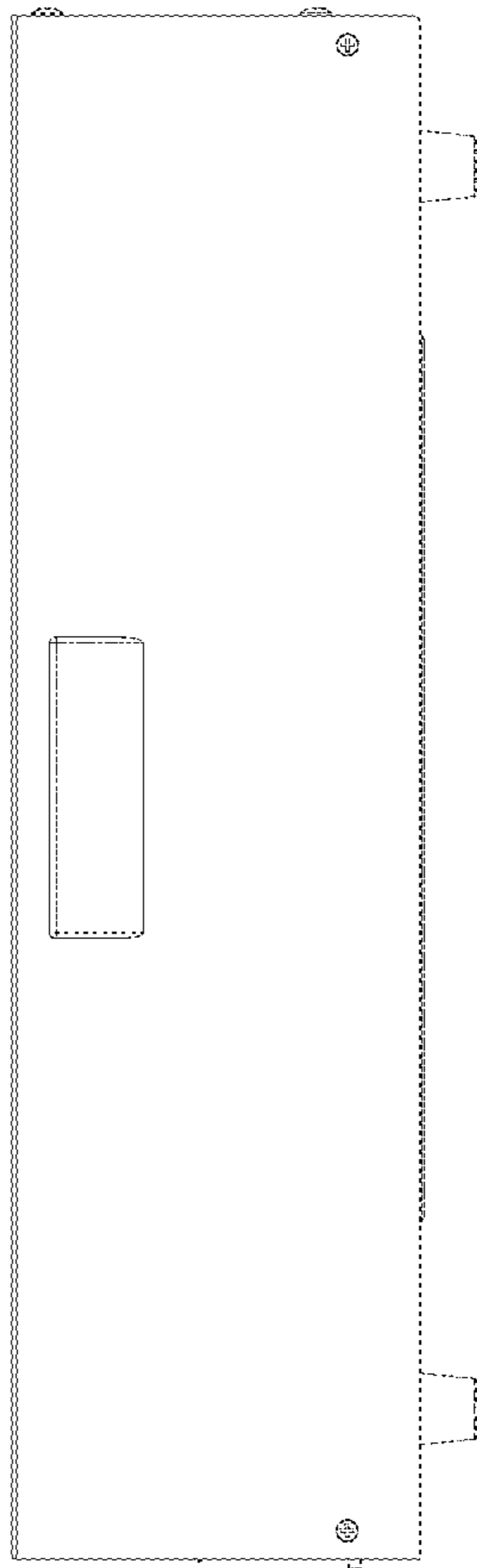

FIG. 4

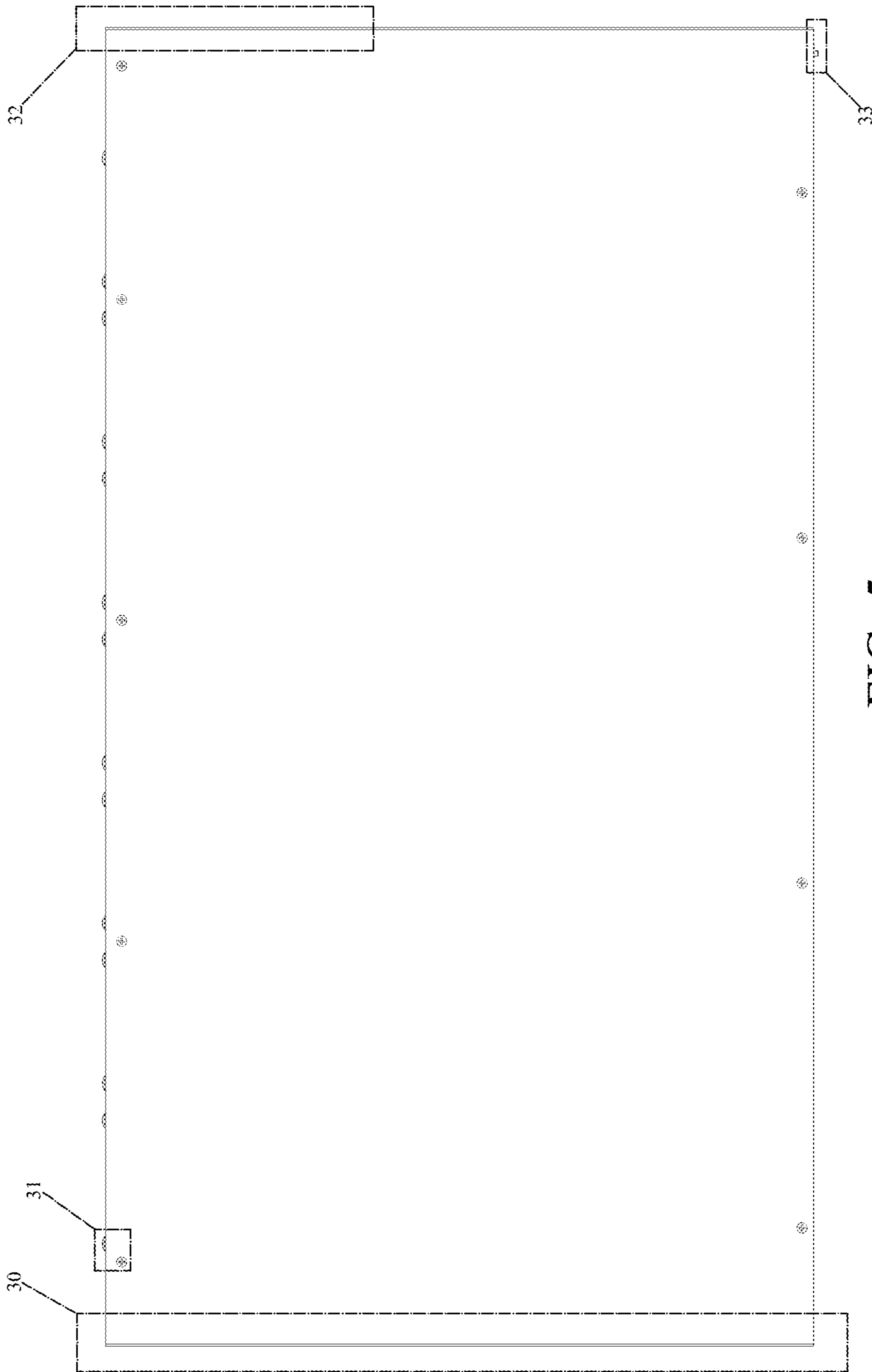

FIG. 5

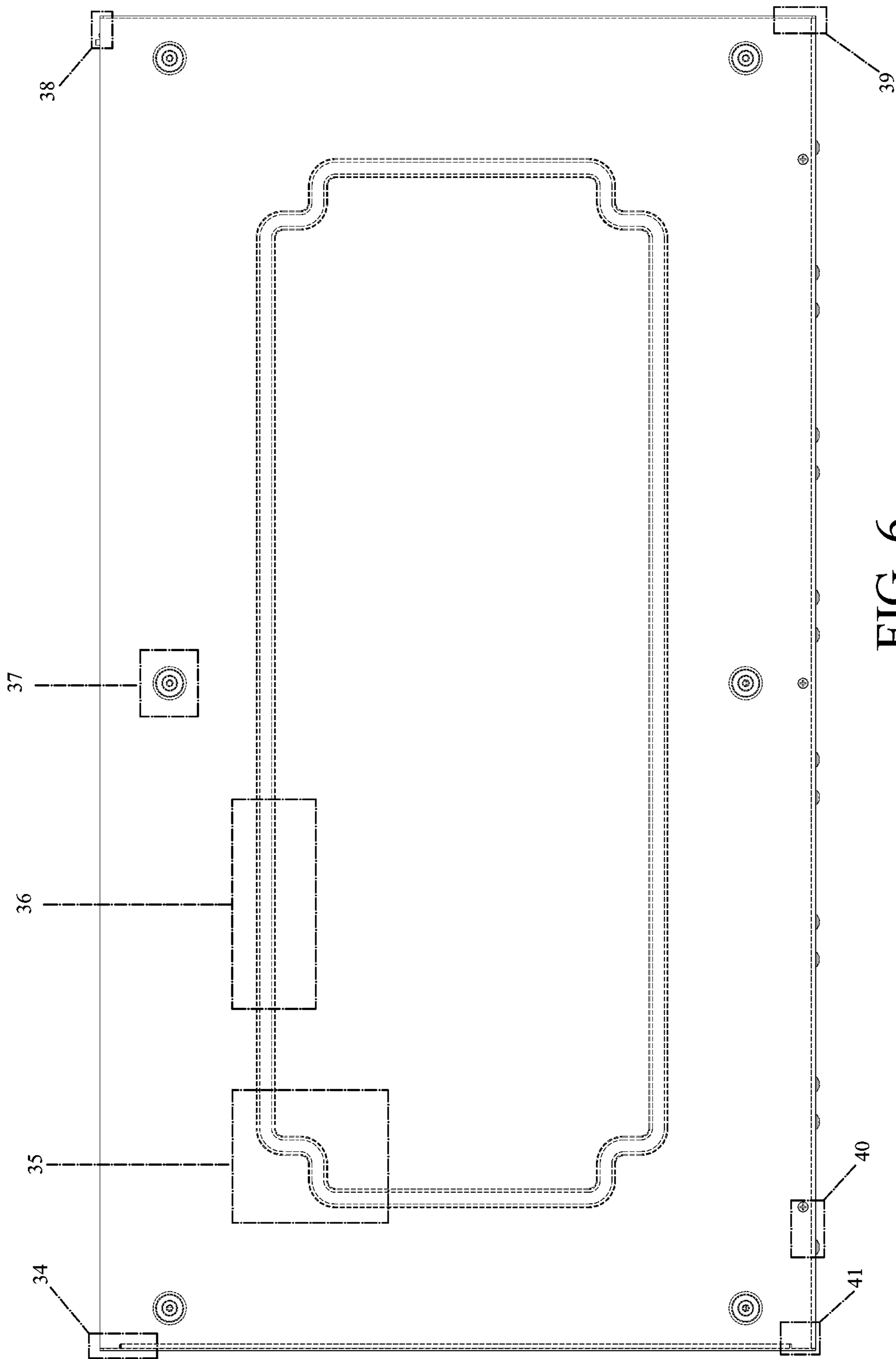

FIG. 6



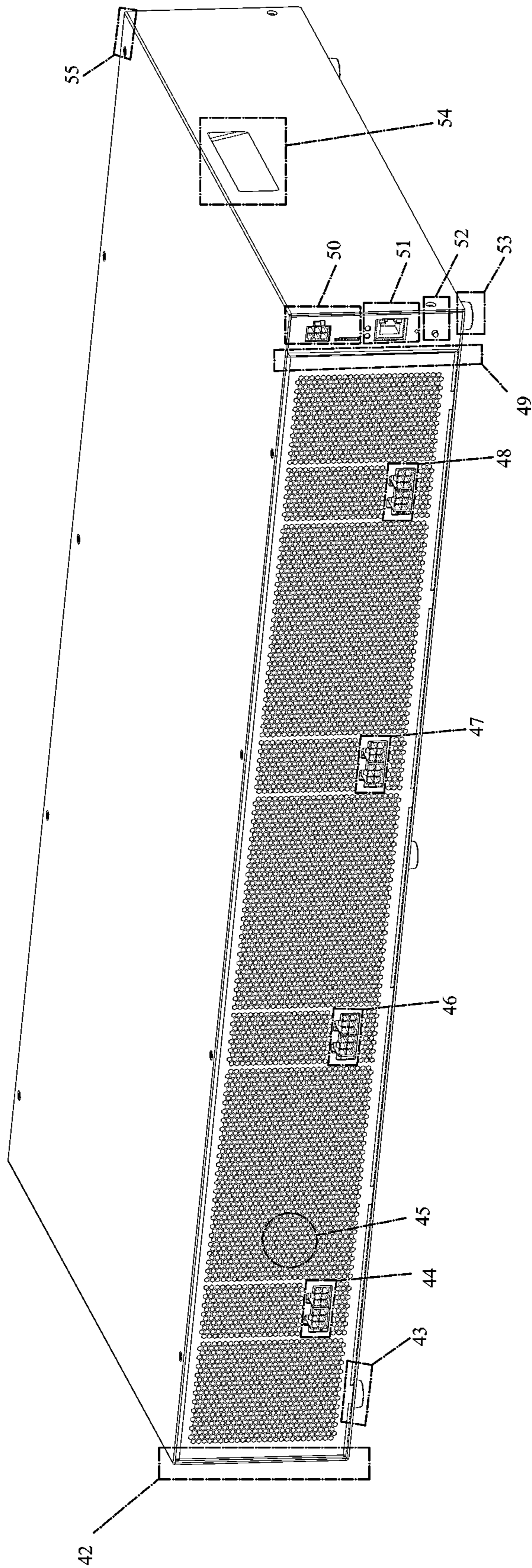

FIG. 7

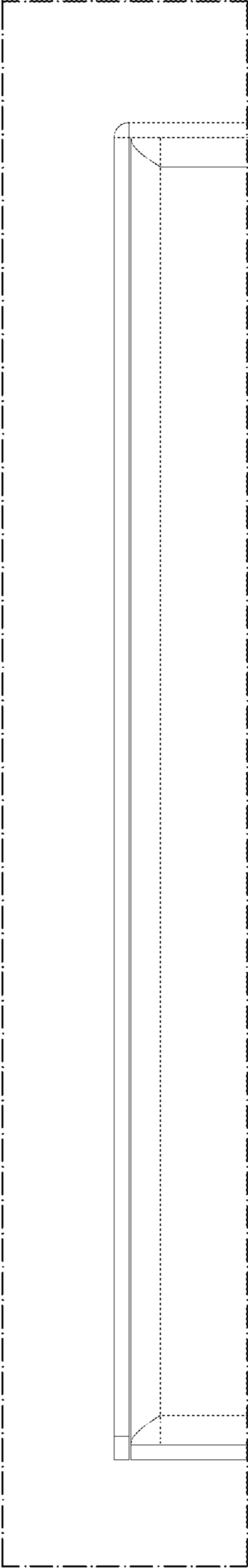

FIG. 8

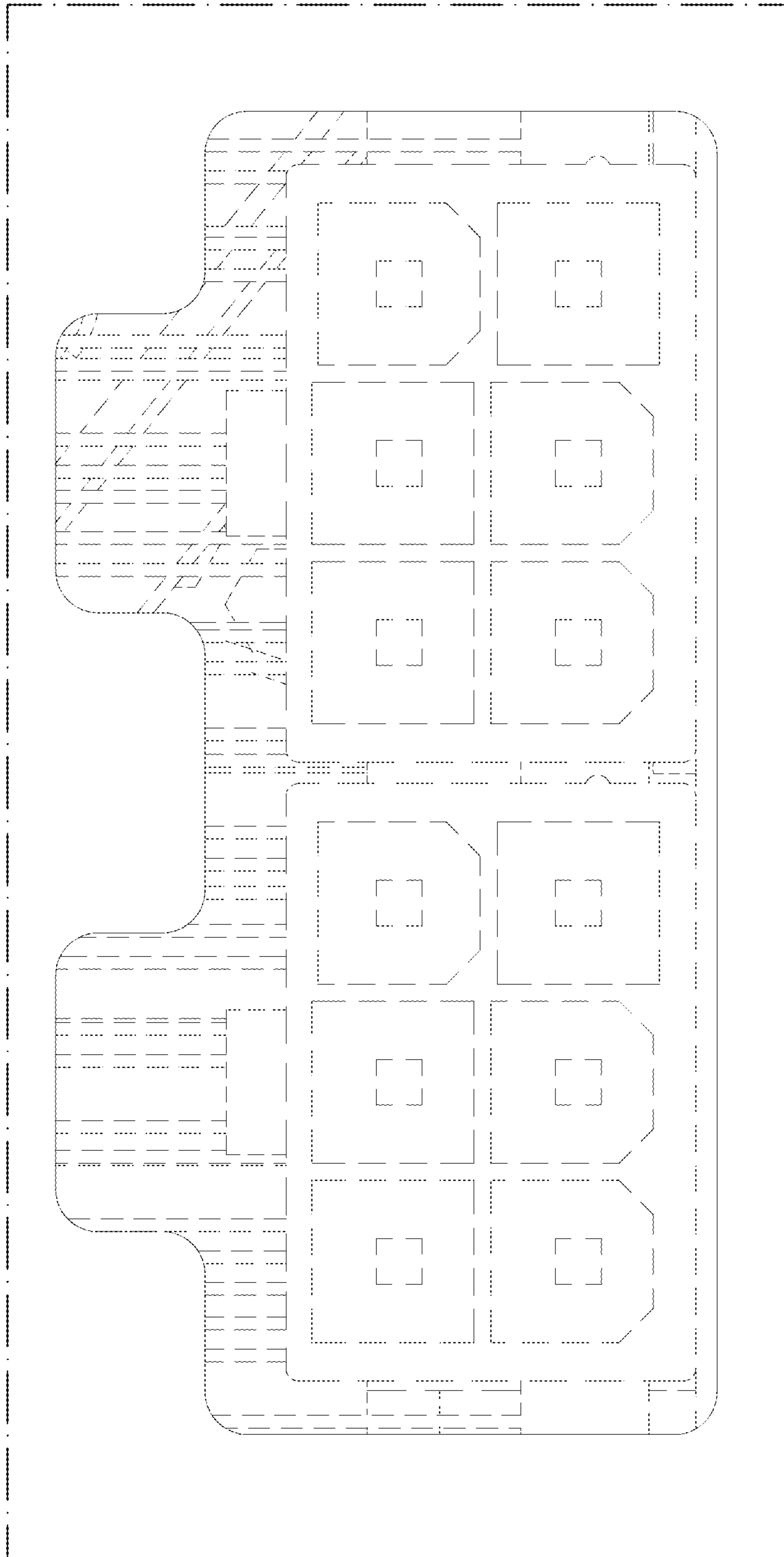

FIG. 9

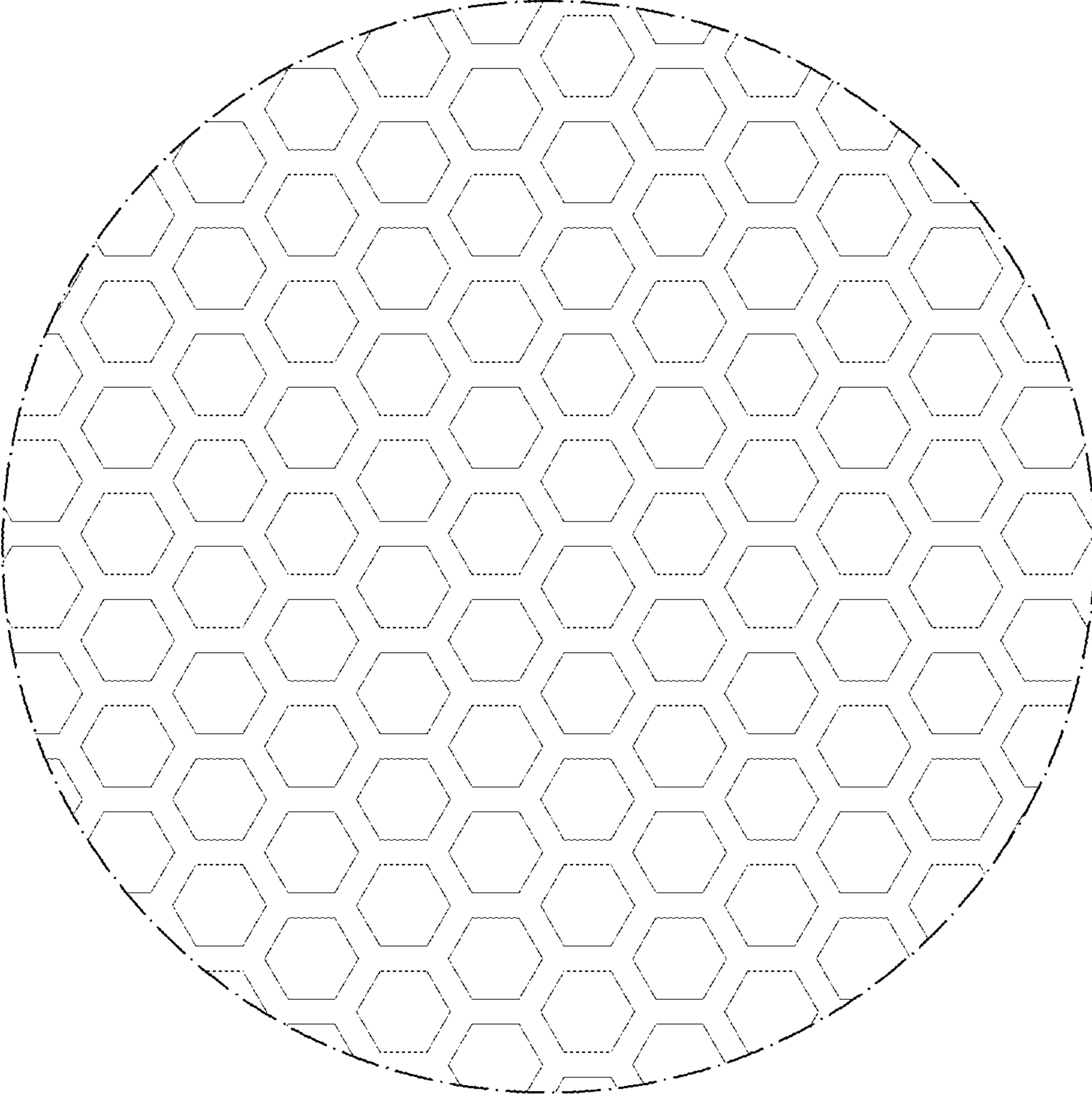

FIG. 10



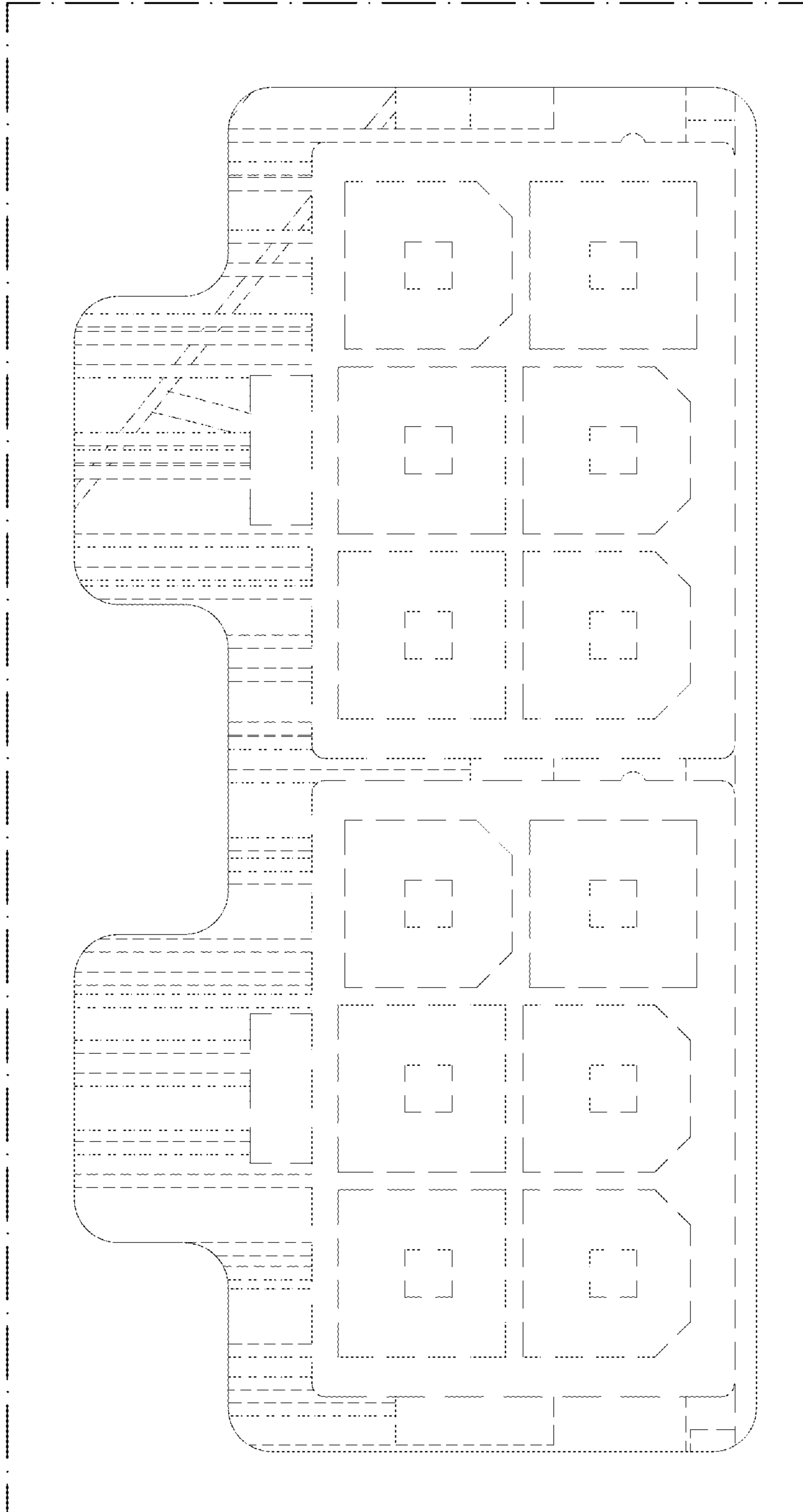

FIG. 11

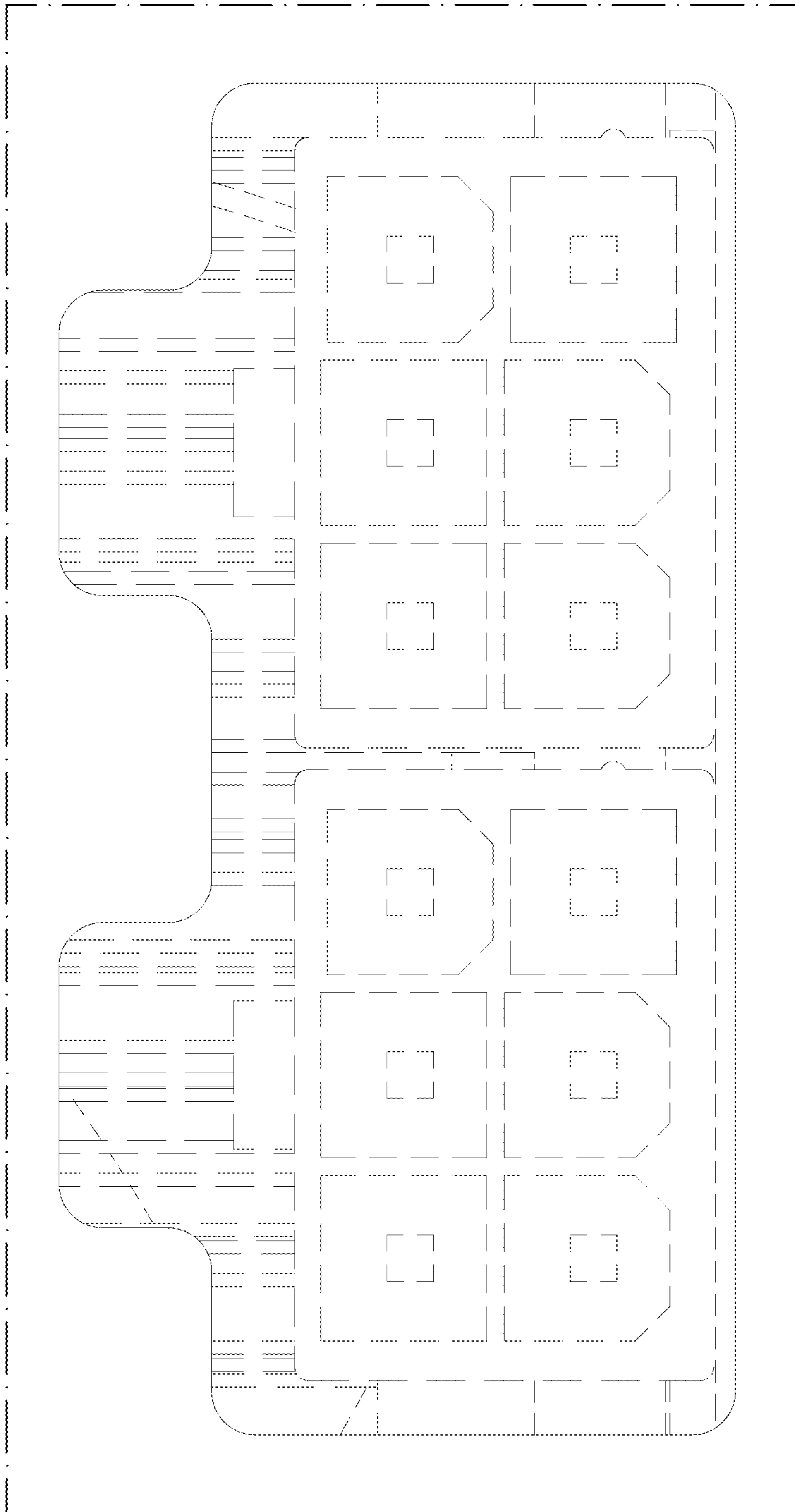

FIG. 12

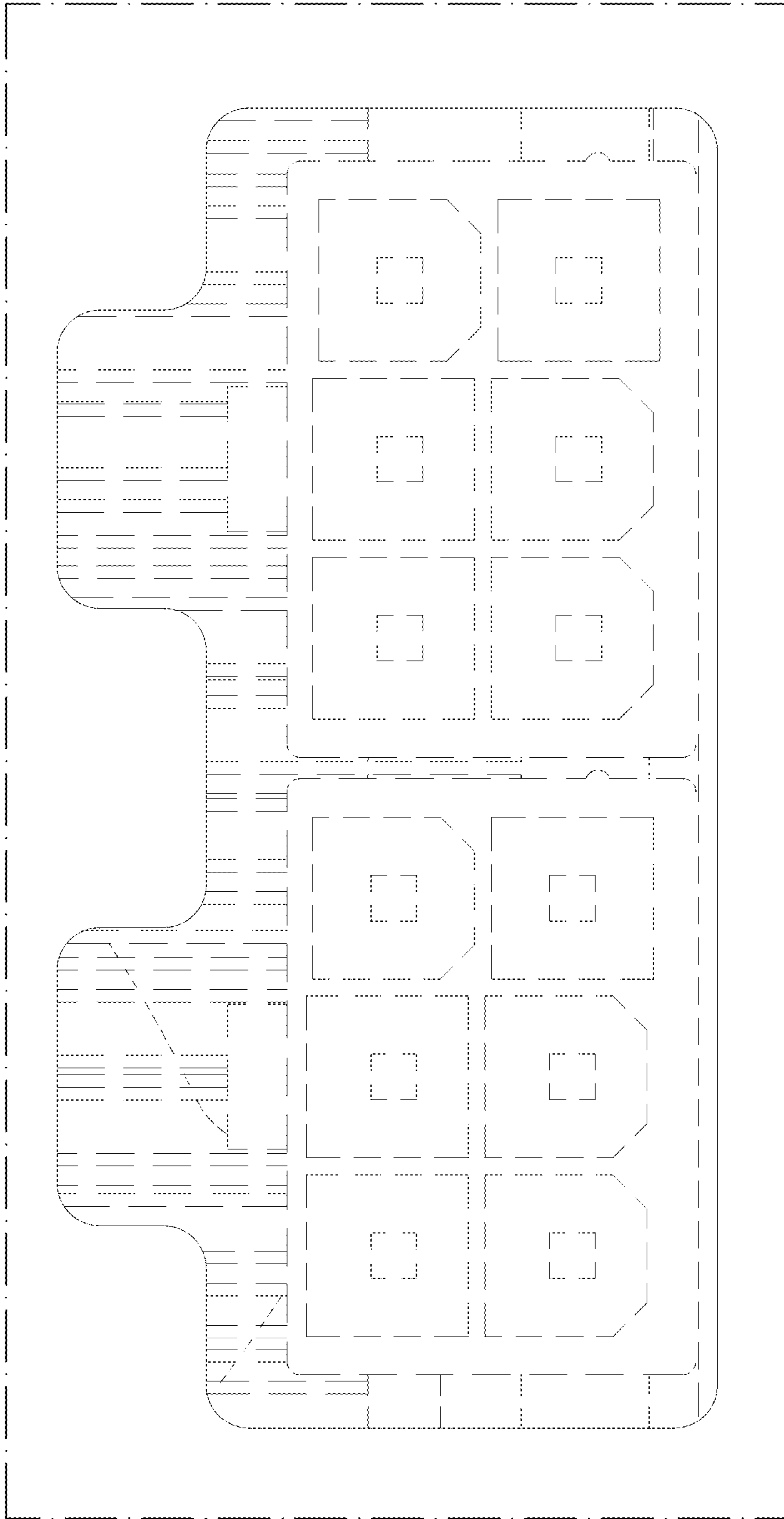

FIG. 13

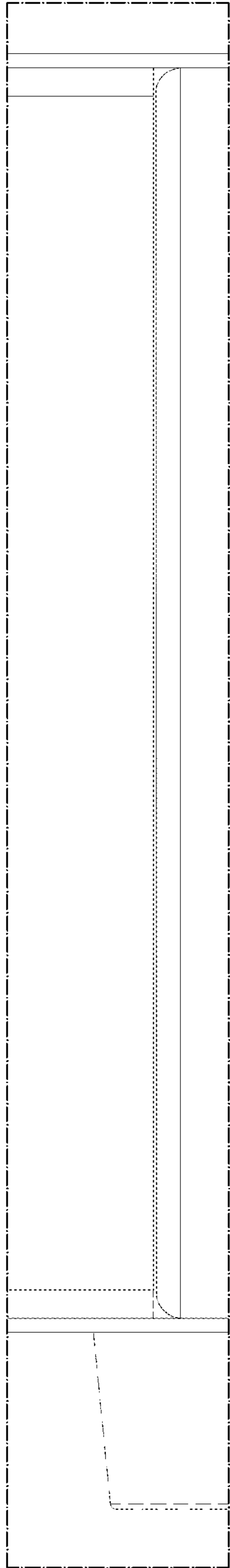

FIG. 14



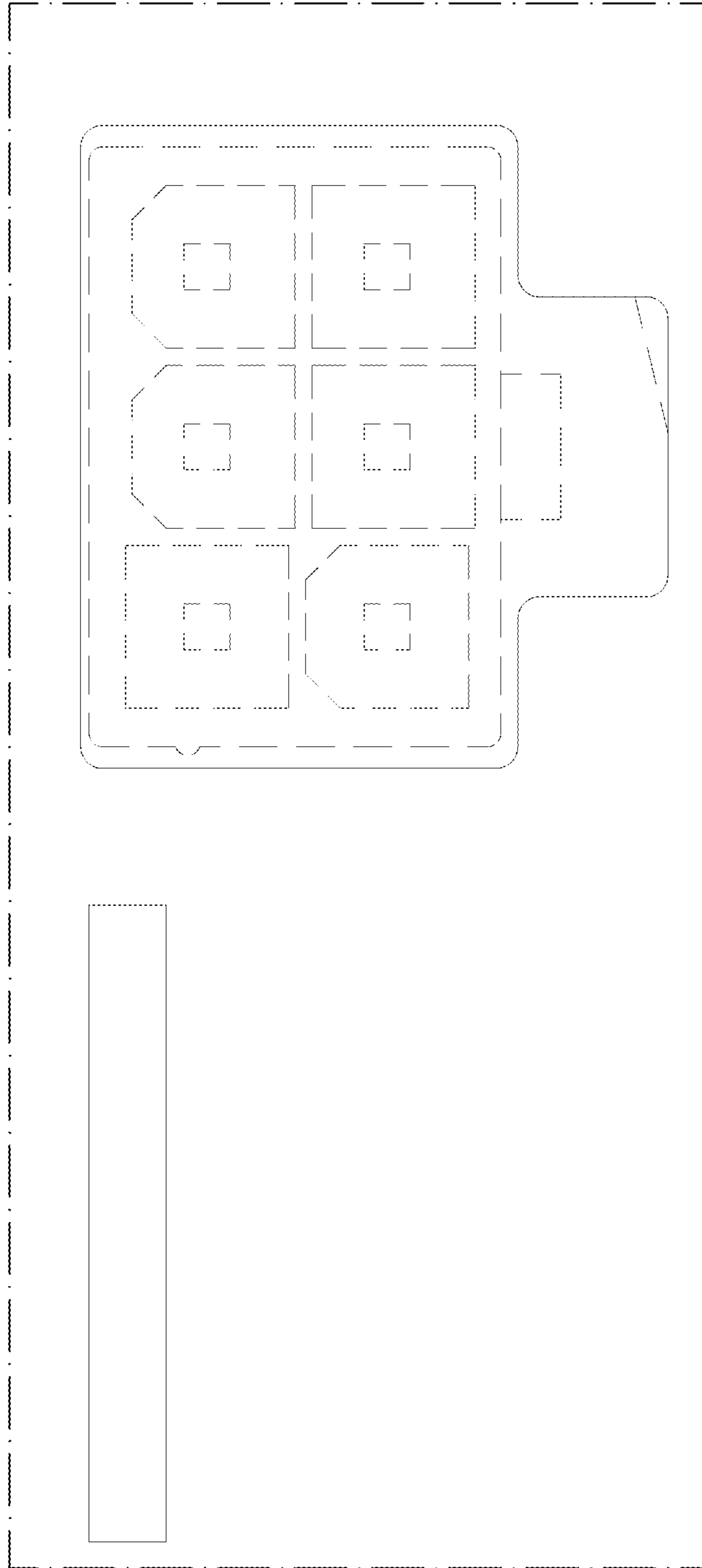

FIG. 15

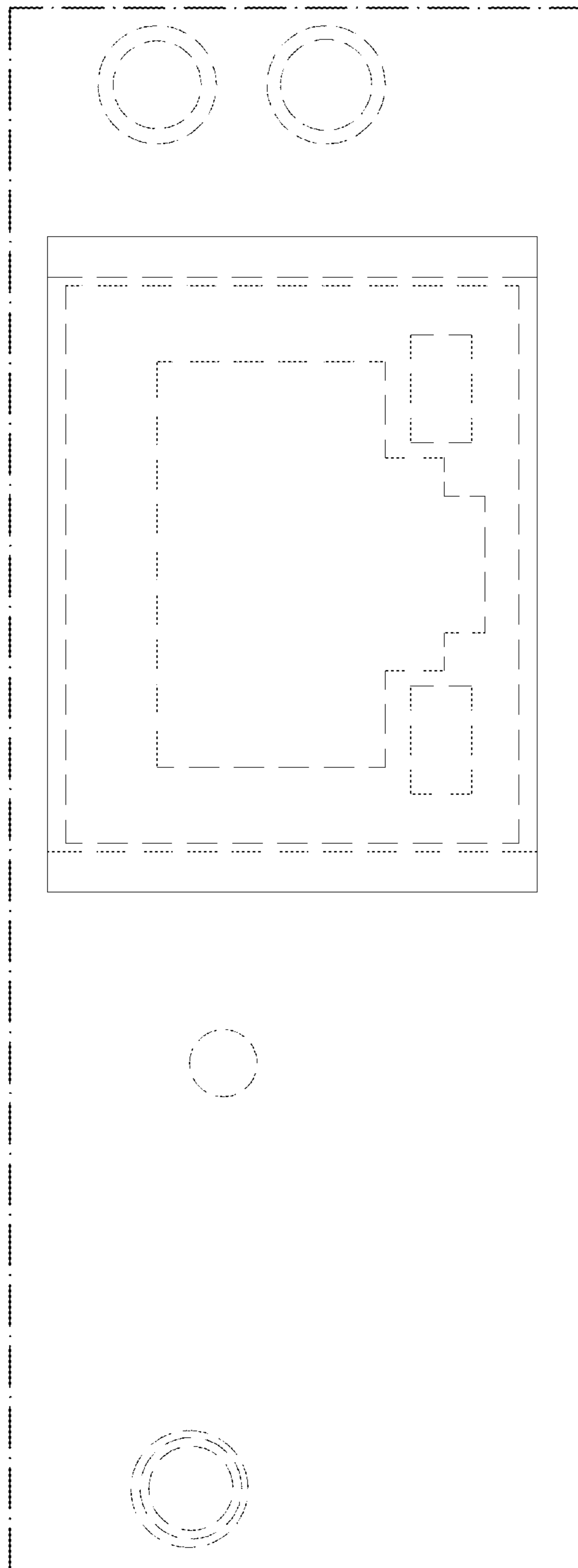

FIG. 16

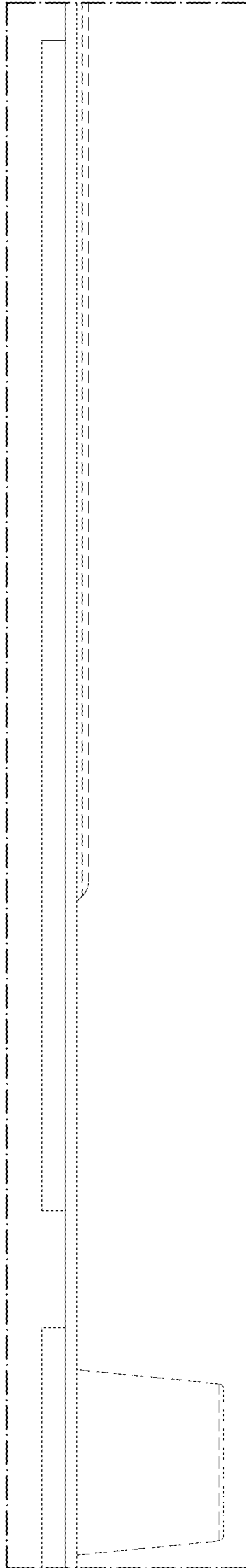

FIG. 17

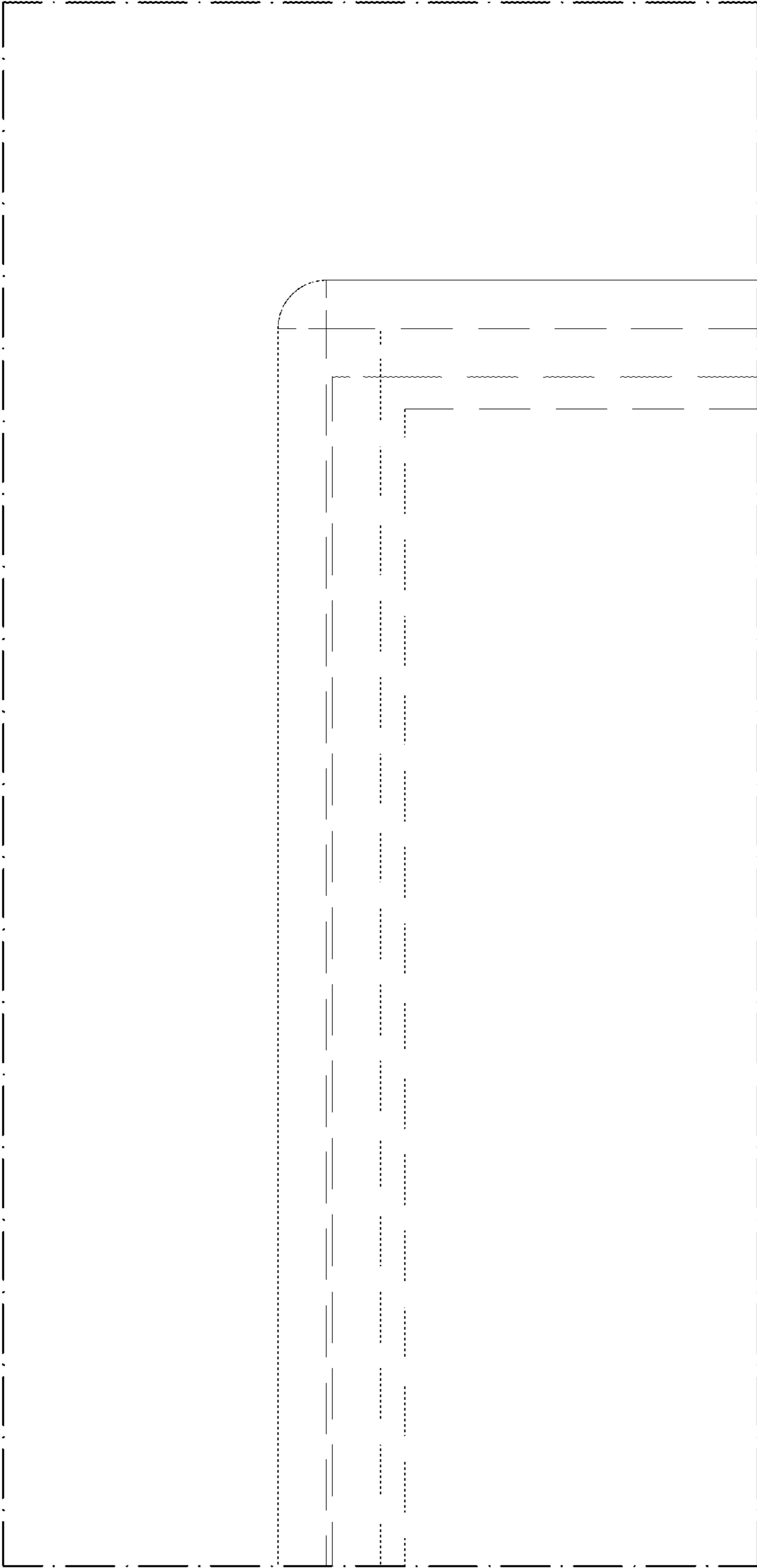

FIG. 18



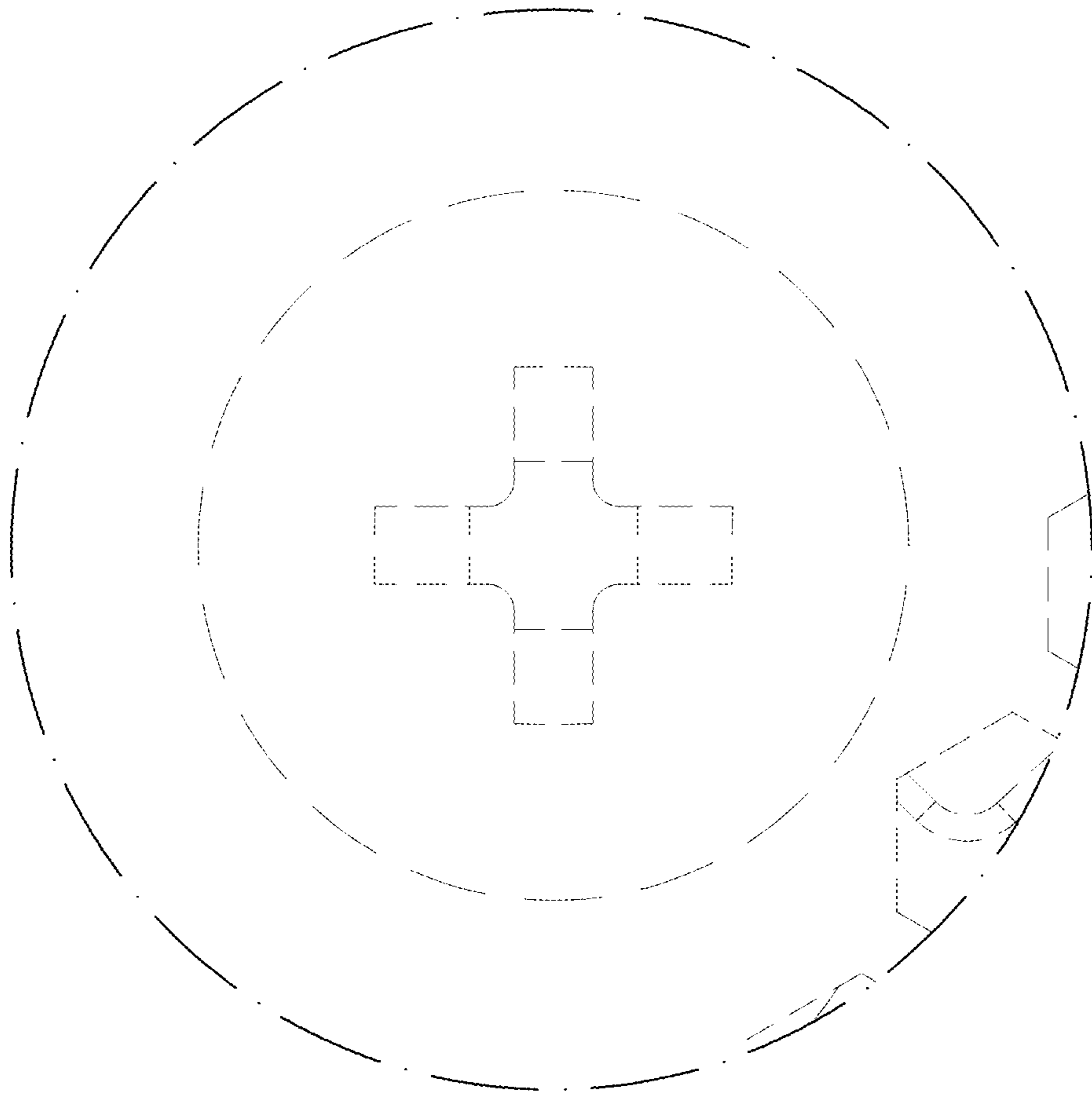

FIG. 19

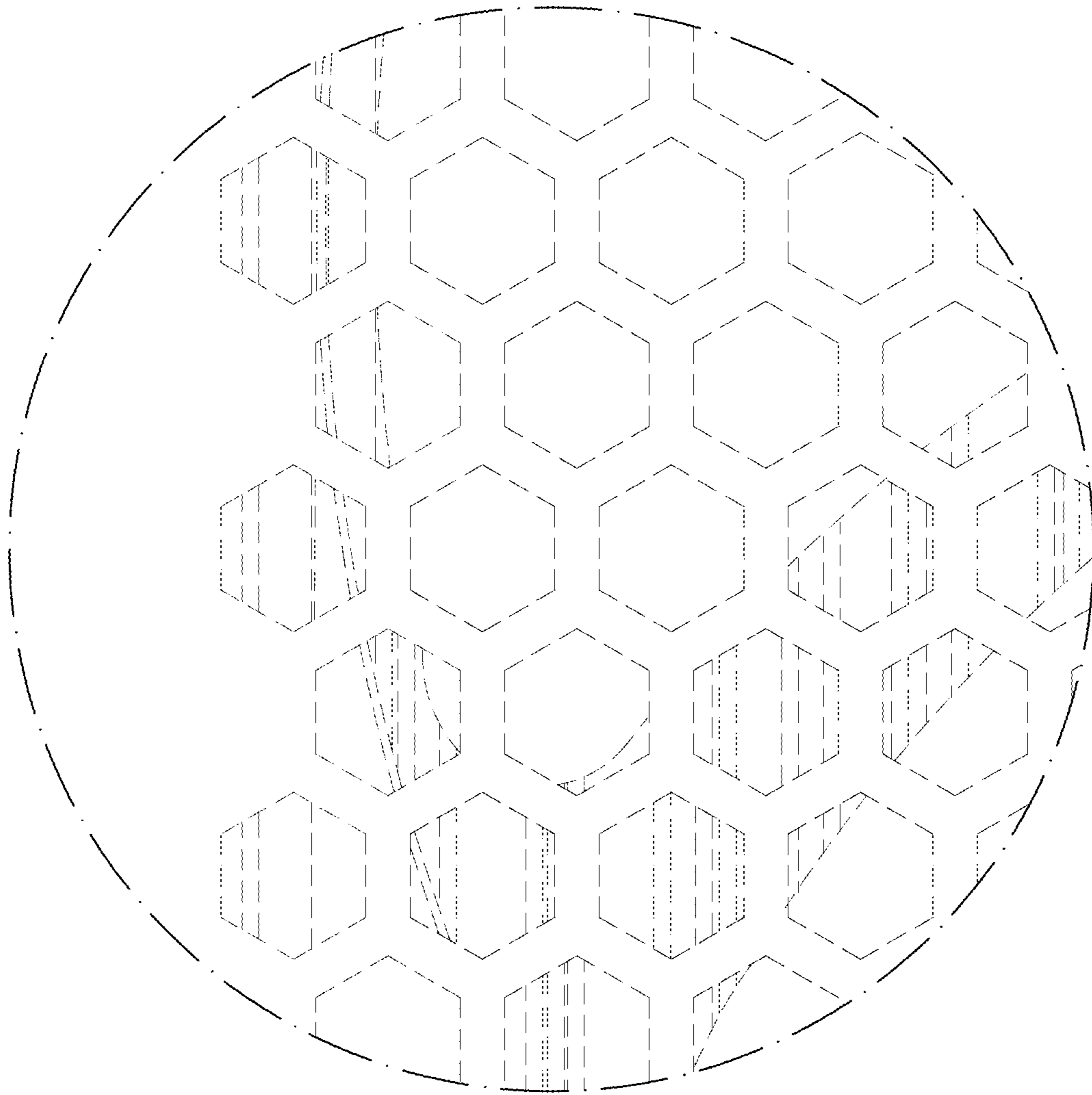

FIG. 20

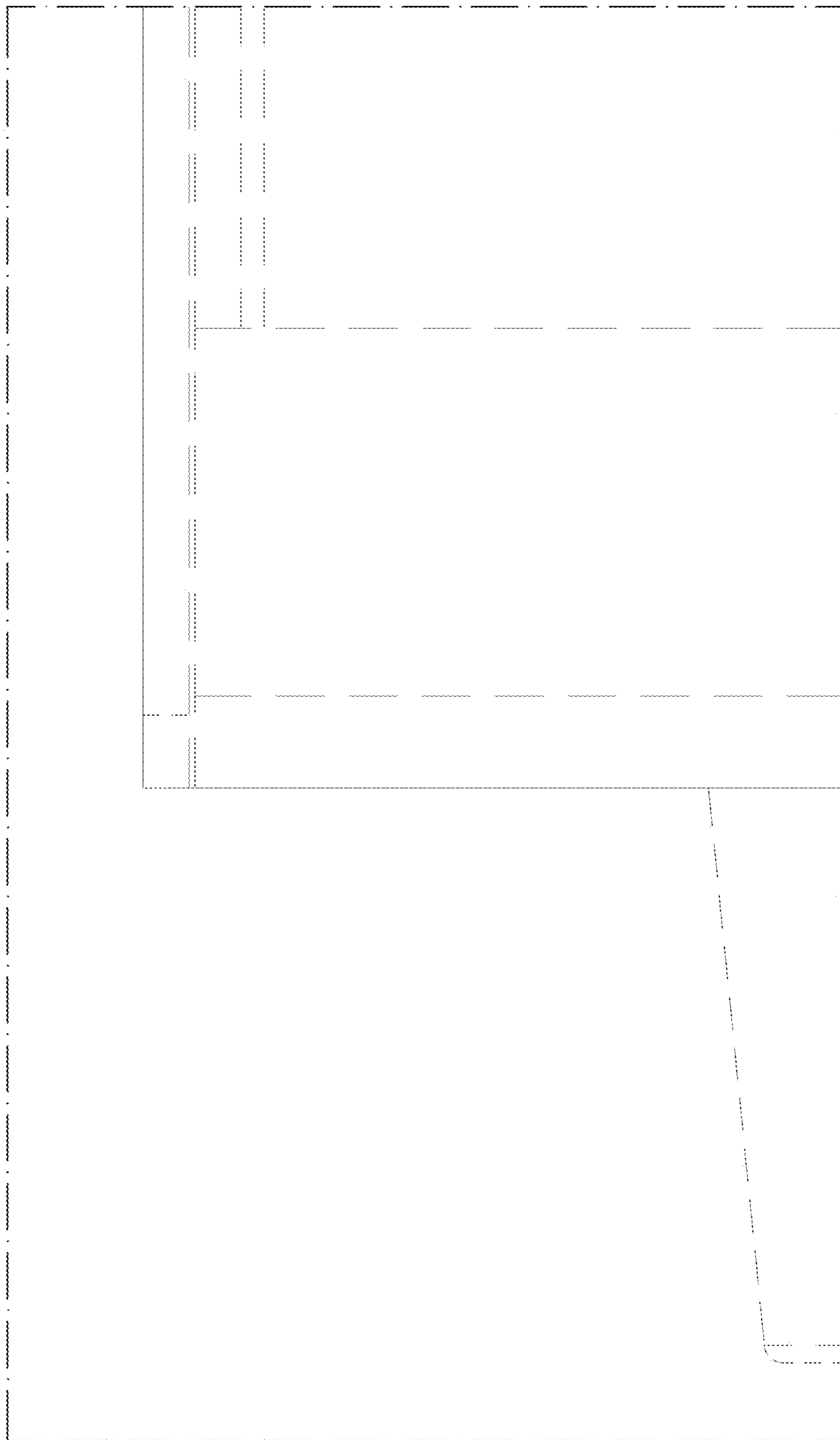

FIG. 21

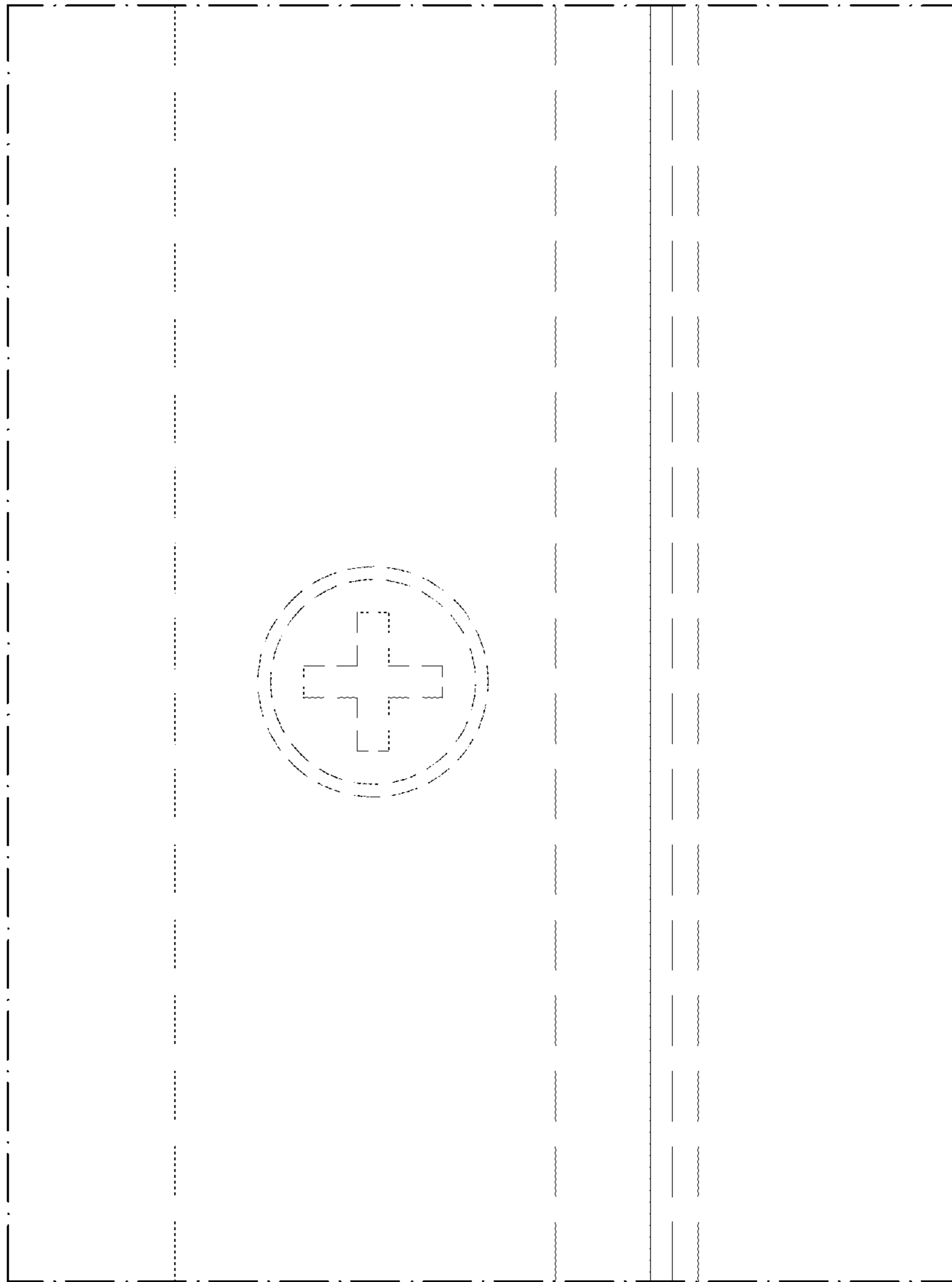

FIG. 22



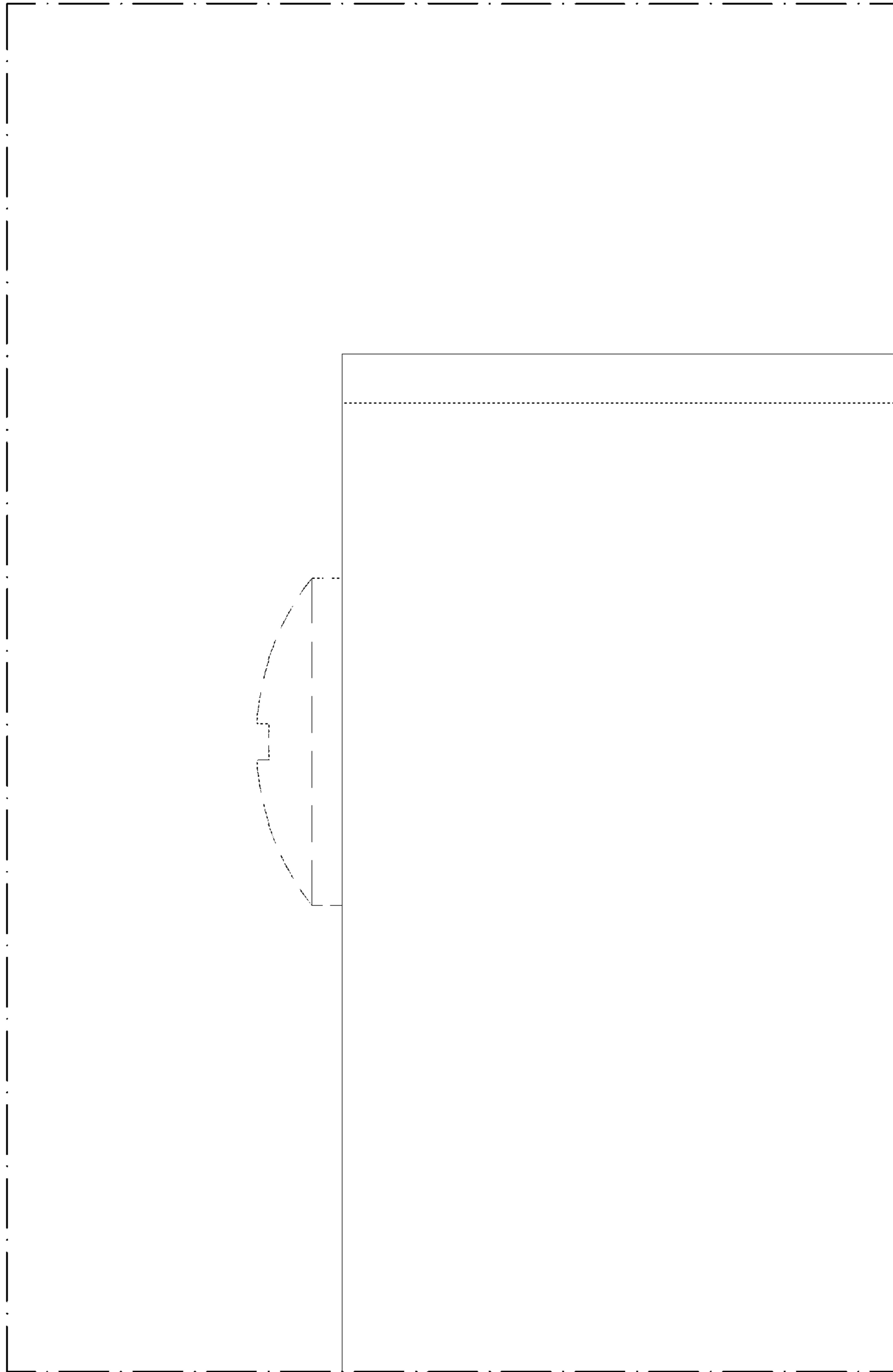

FIG. 23

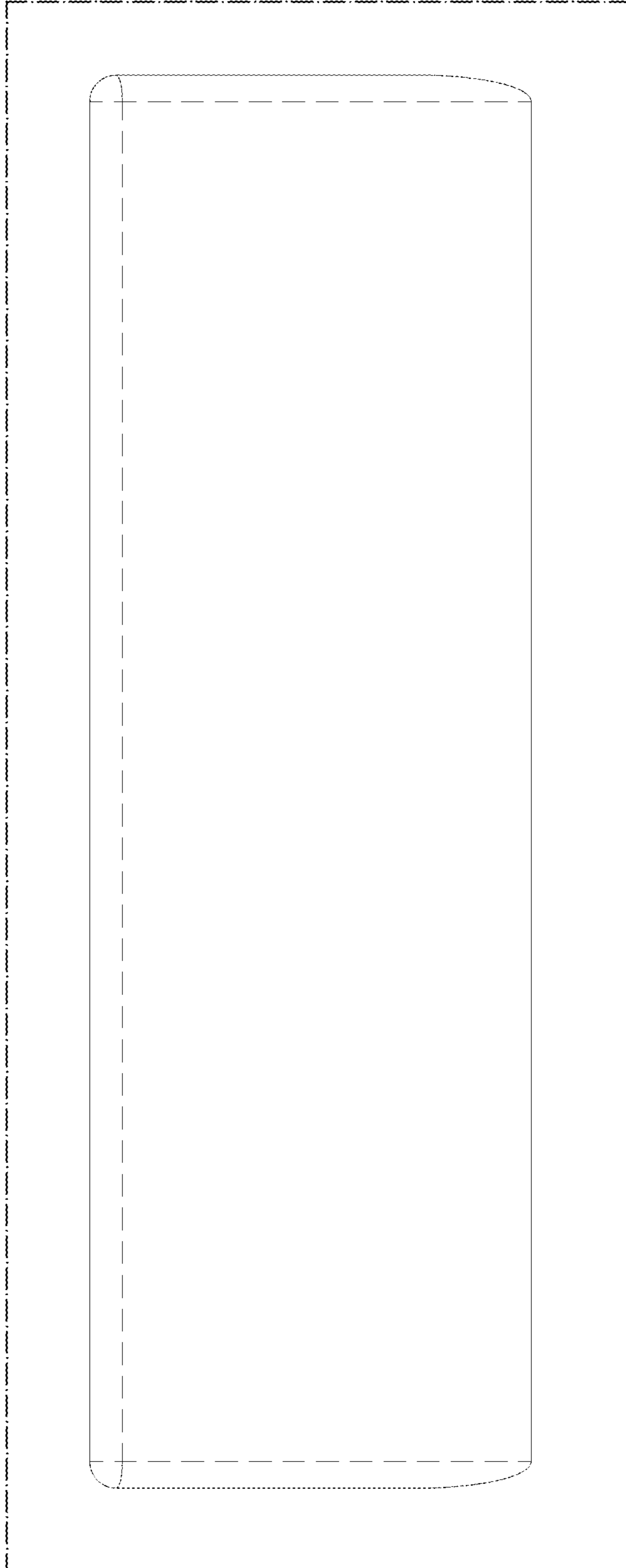

FIG. 24

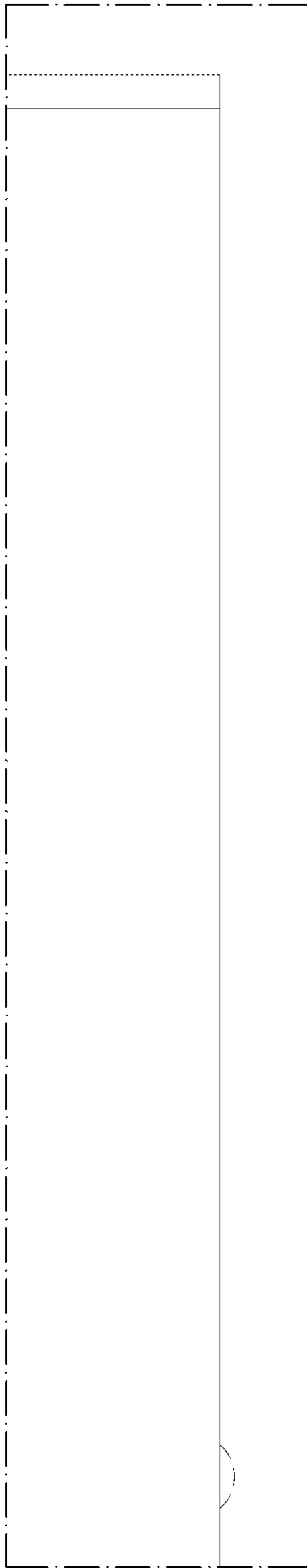

FIG. 25

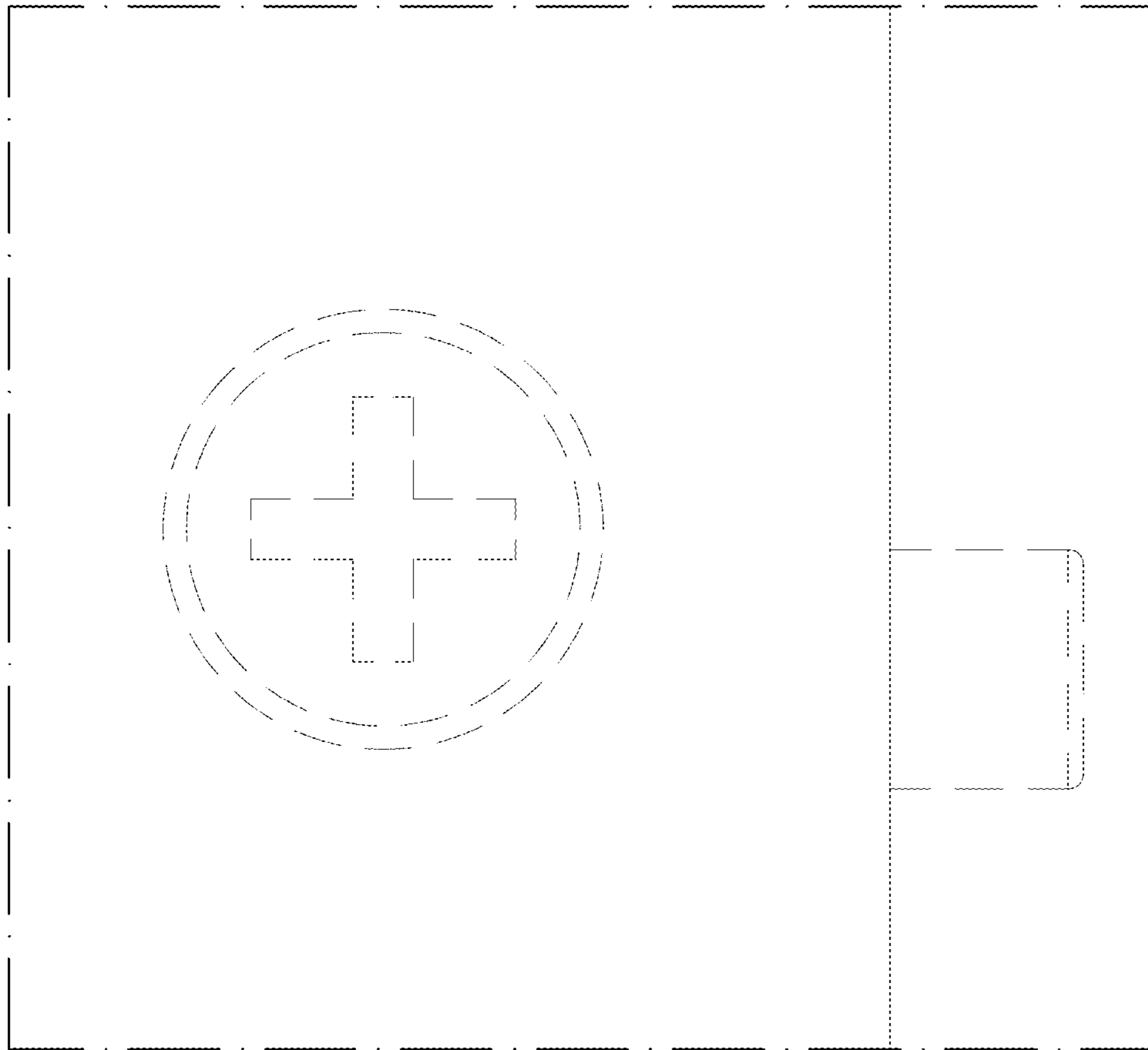

FIG. 26

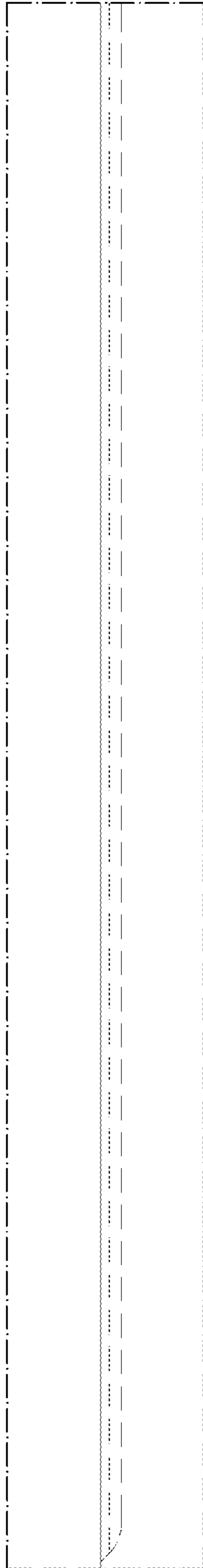

FIG. 27

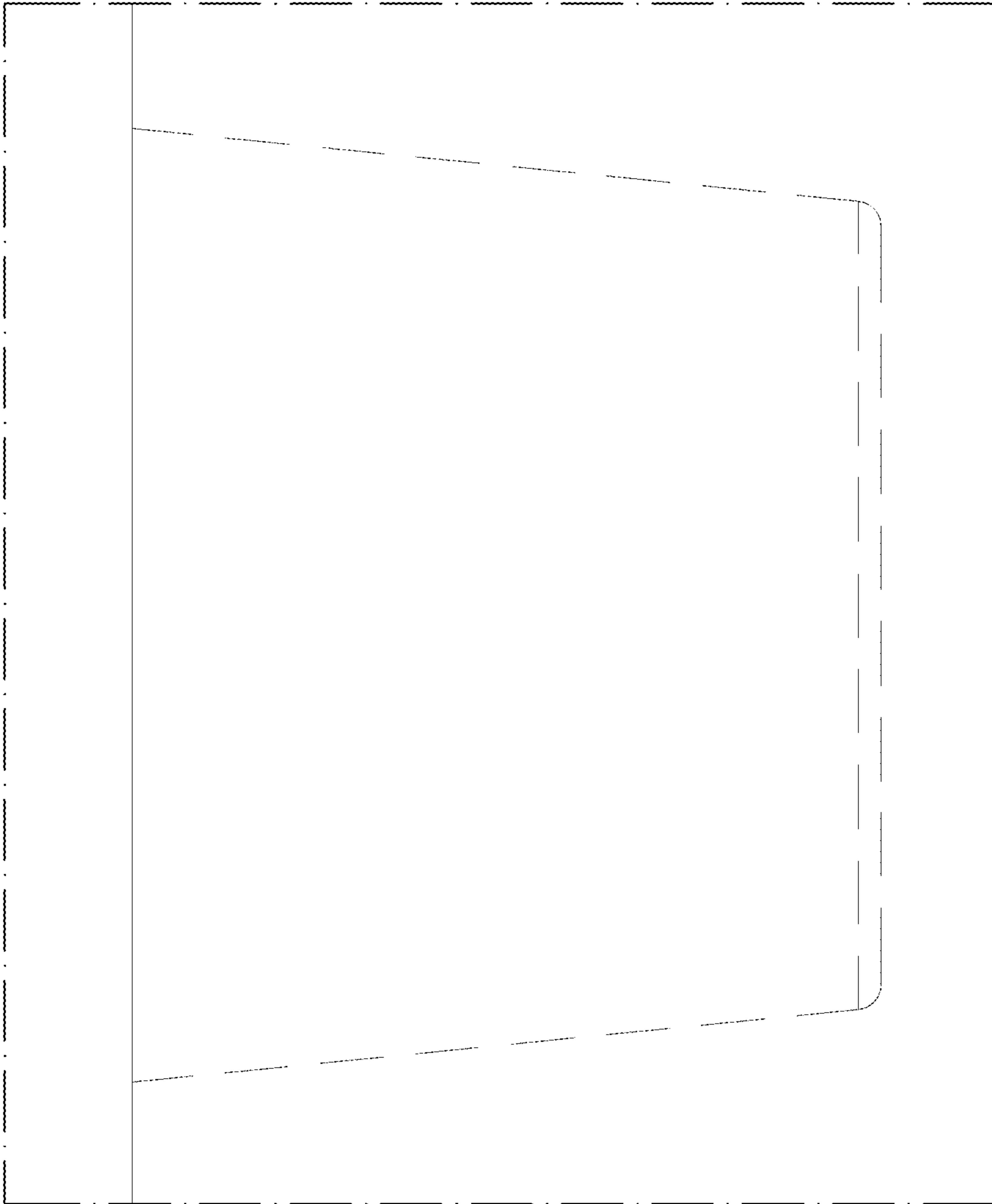

FIG. 28



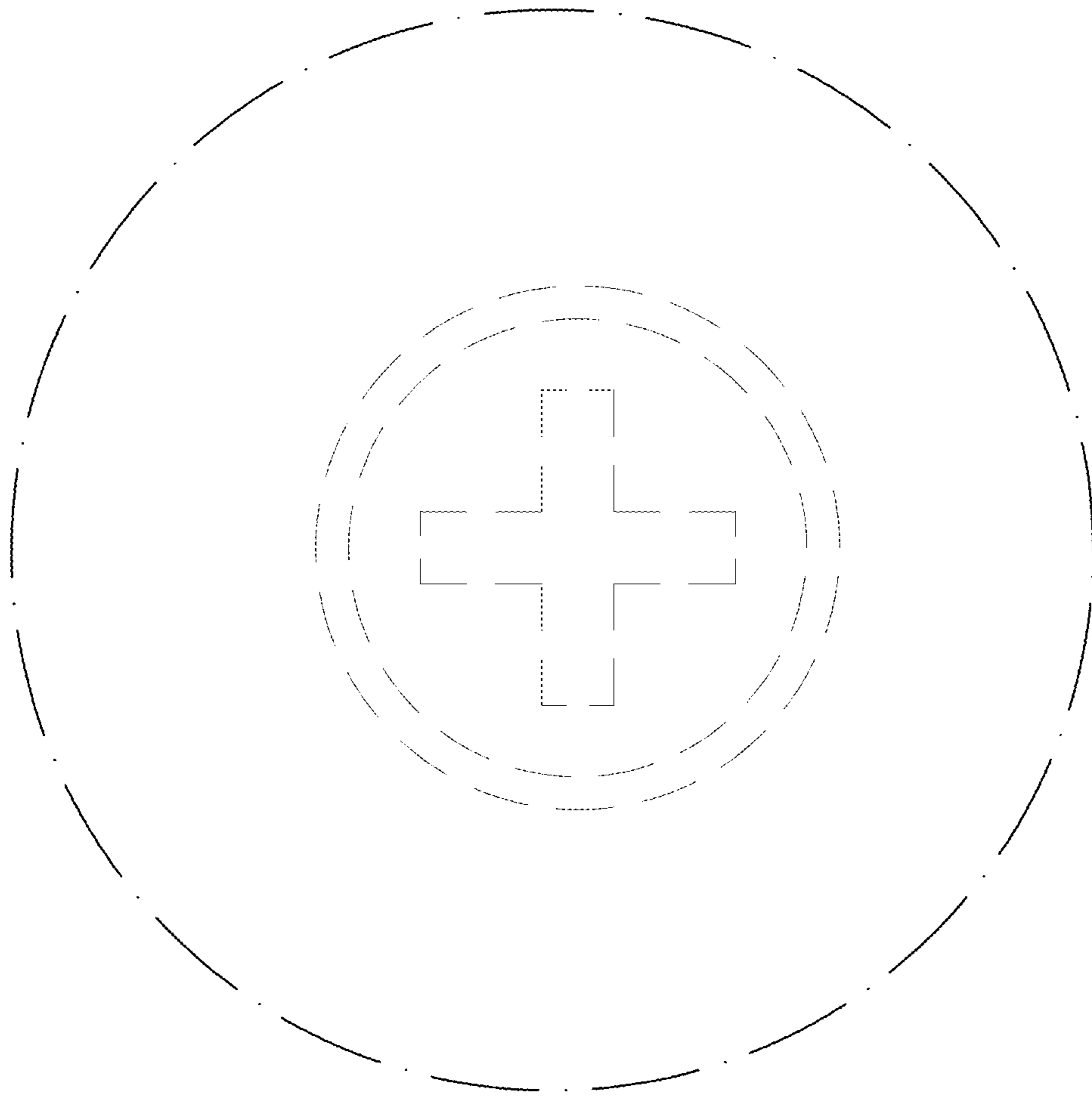

FIG. 29

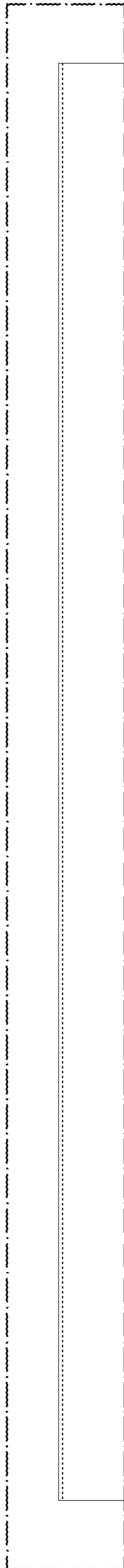

FIG. 30

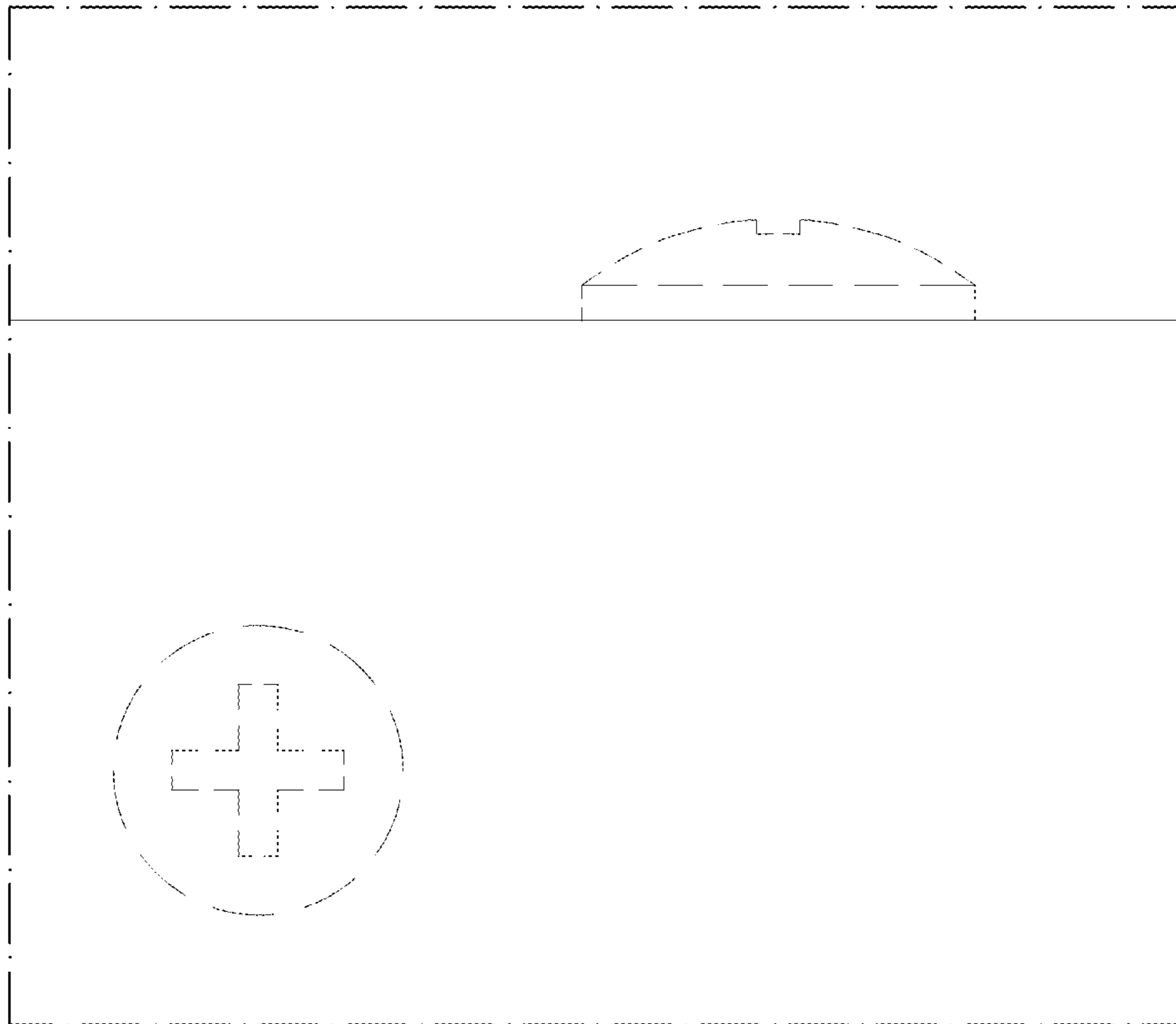

FIG. 31

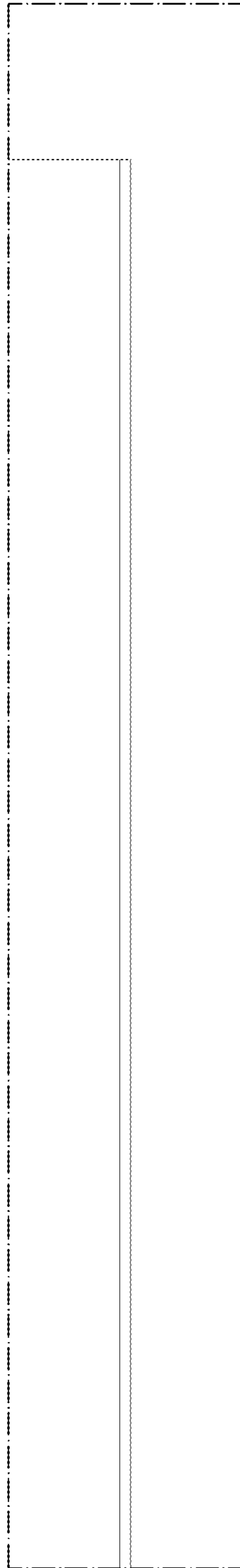

FIG. 32

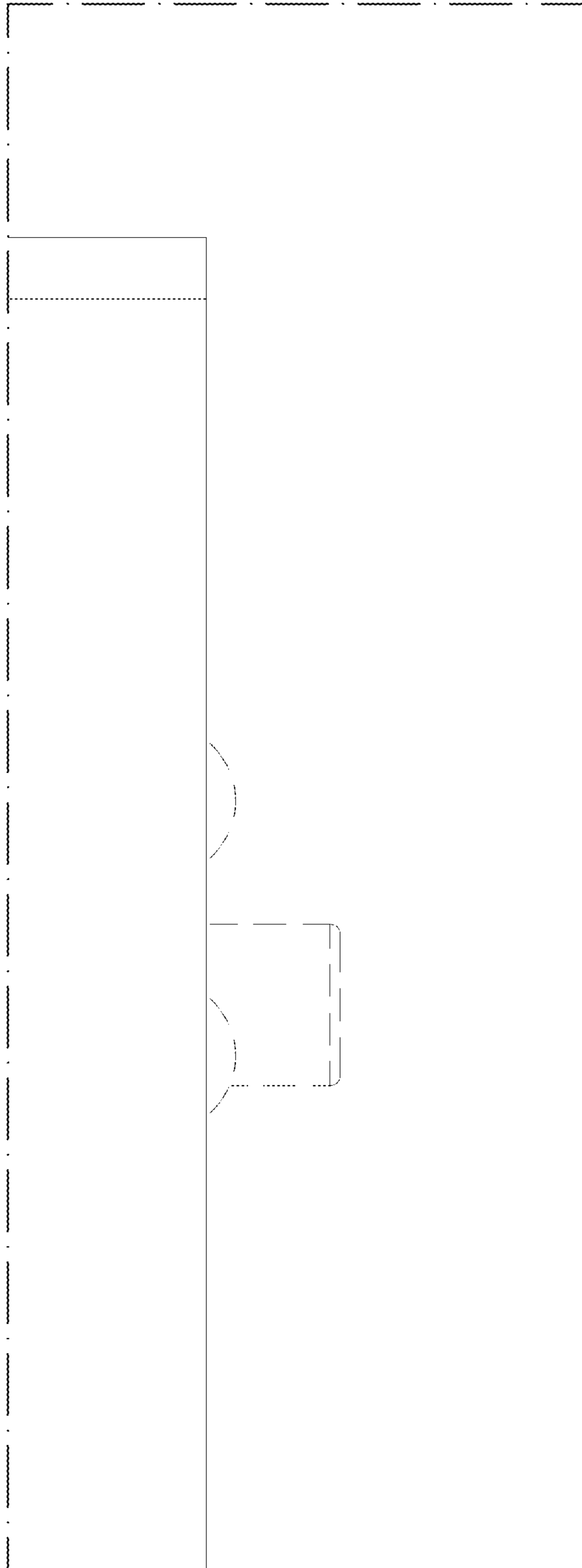

FIG. 33

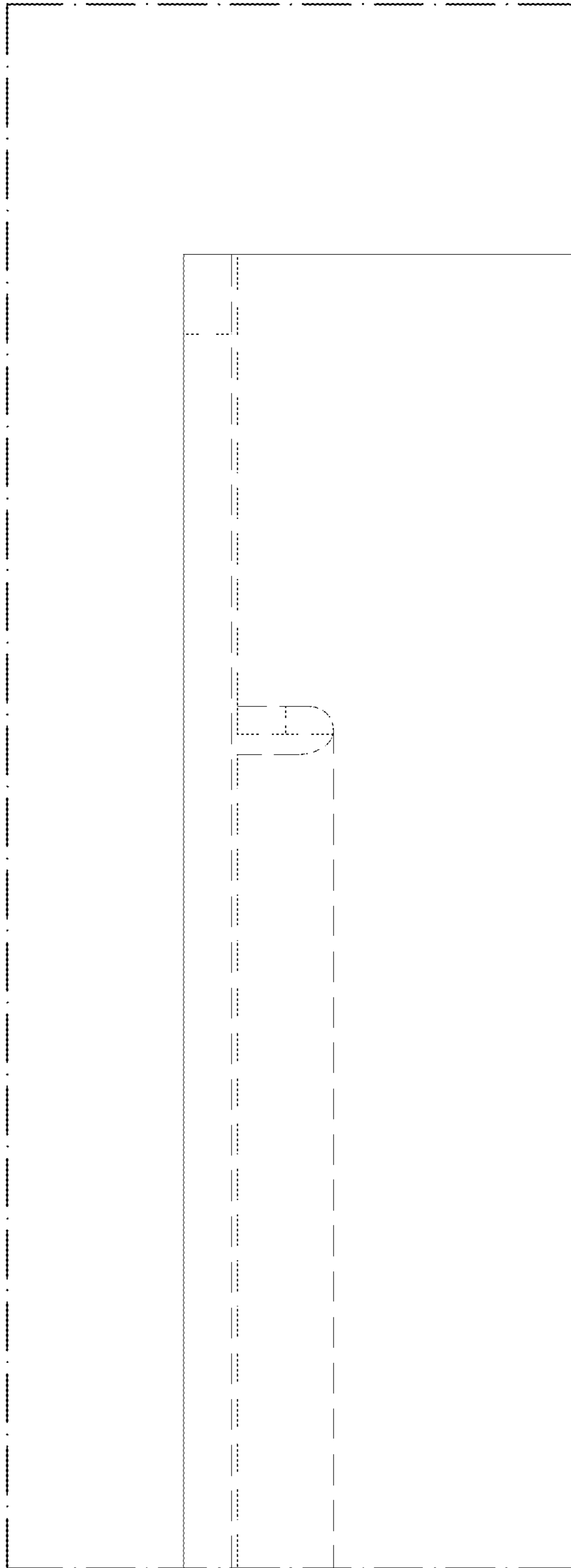

FIG. 34



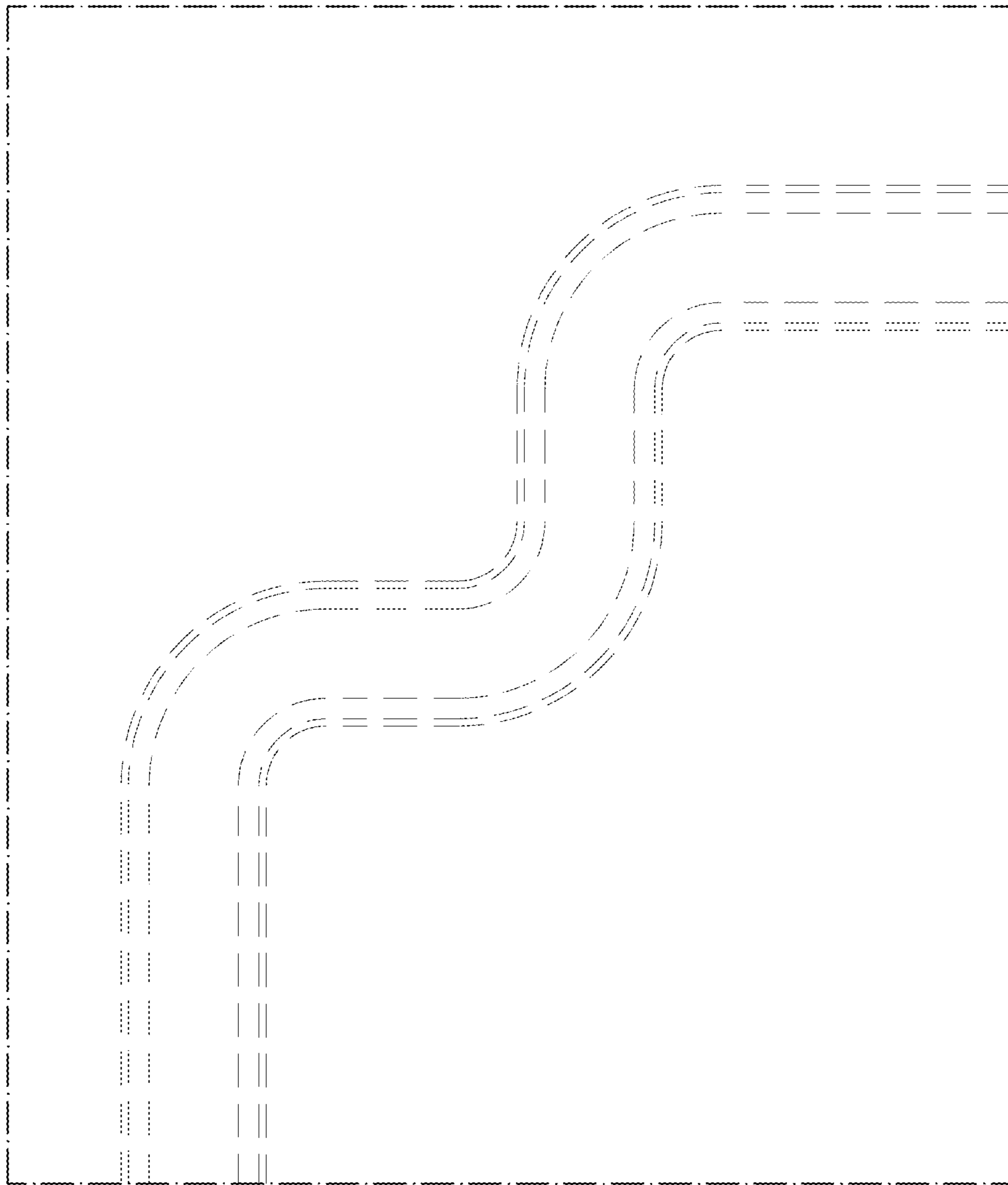

FIG. 35

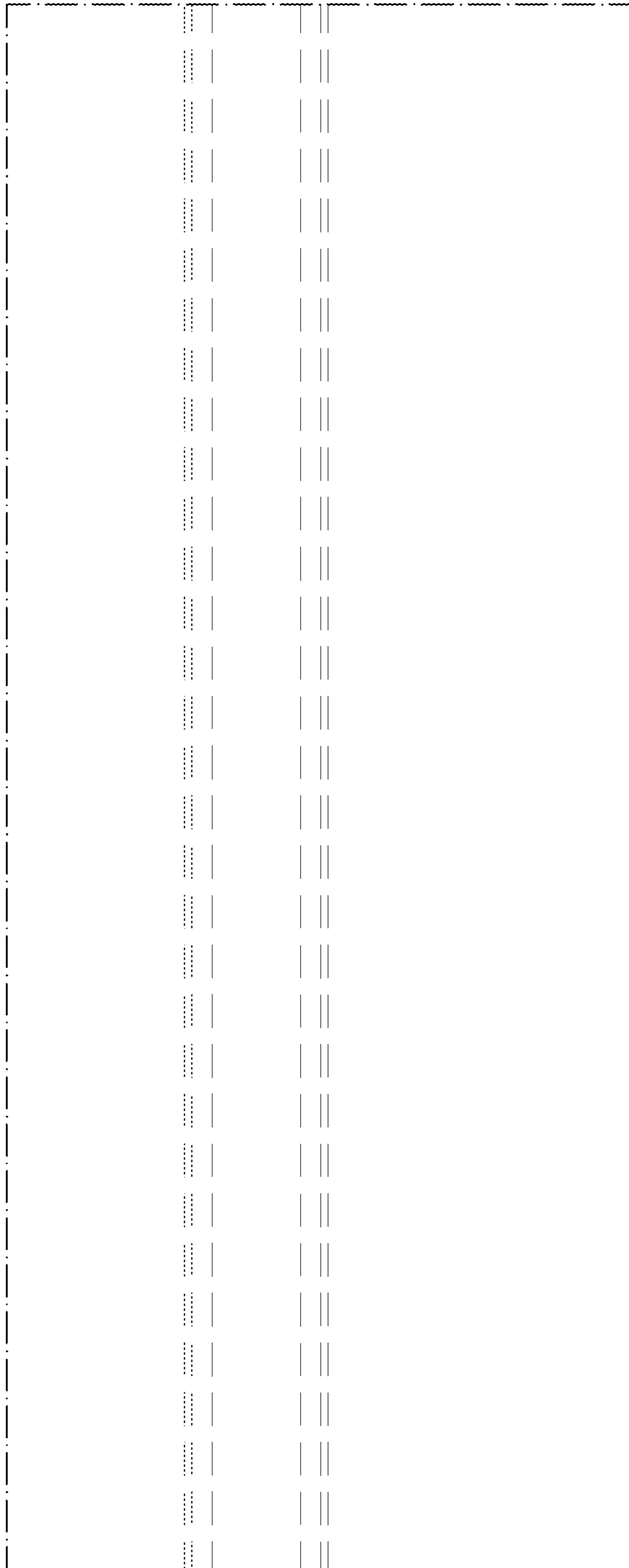

FIG. 36

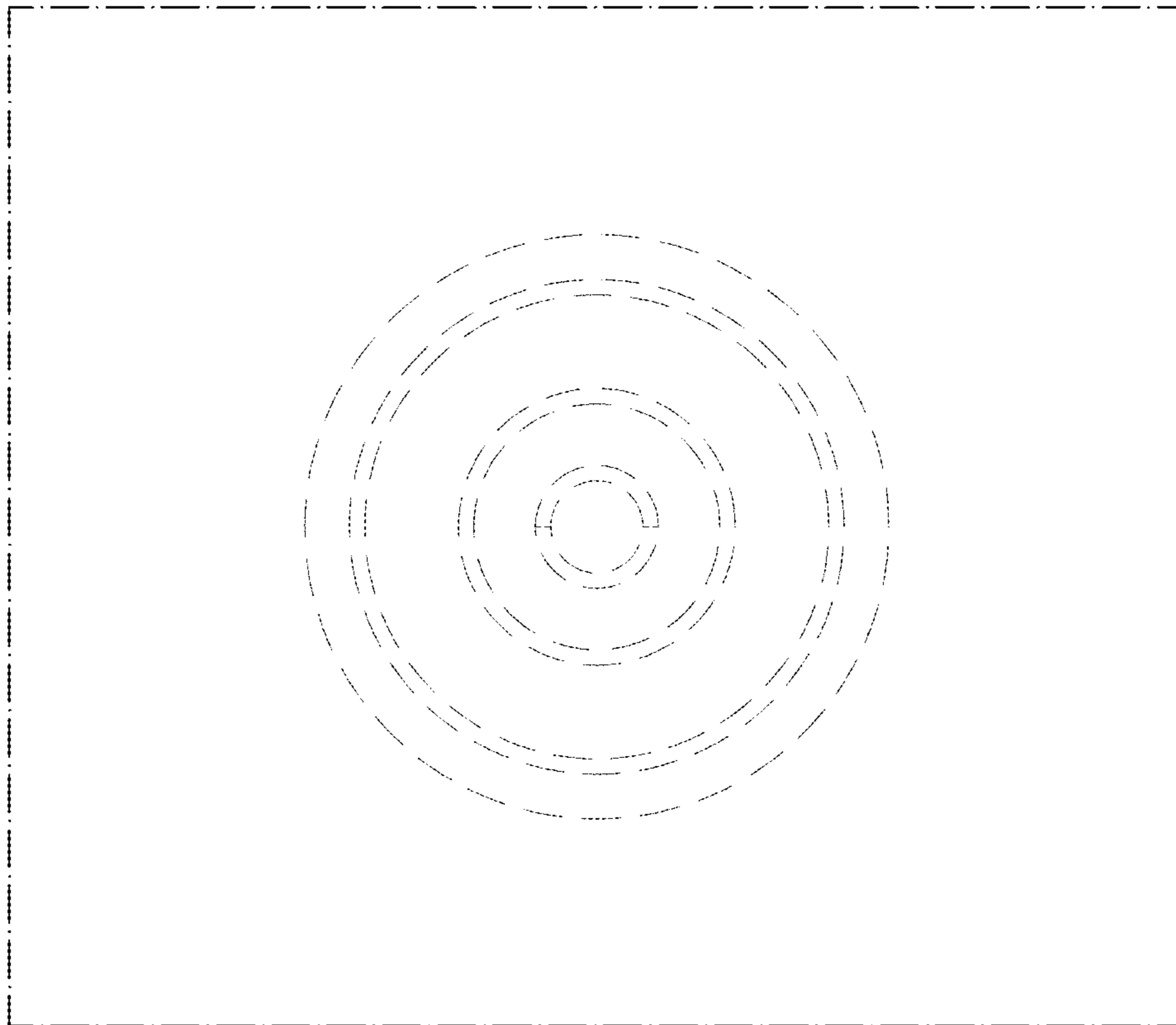

FIG. 37

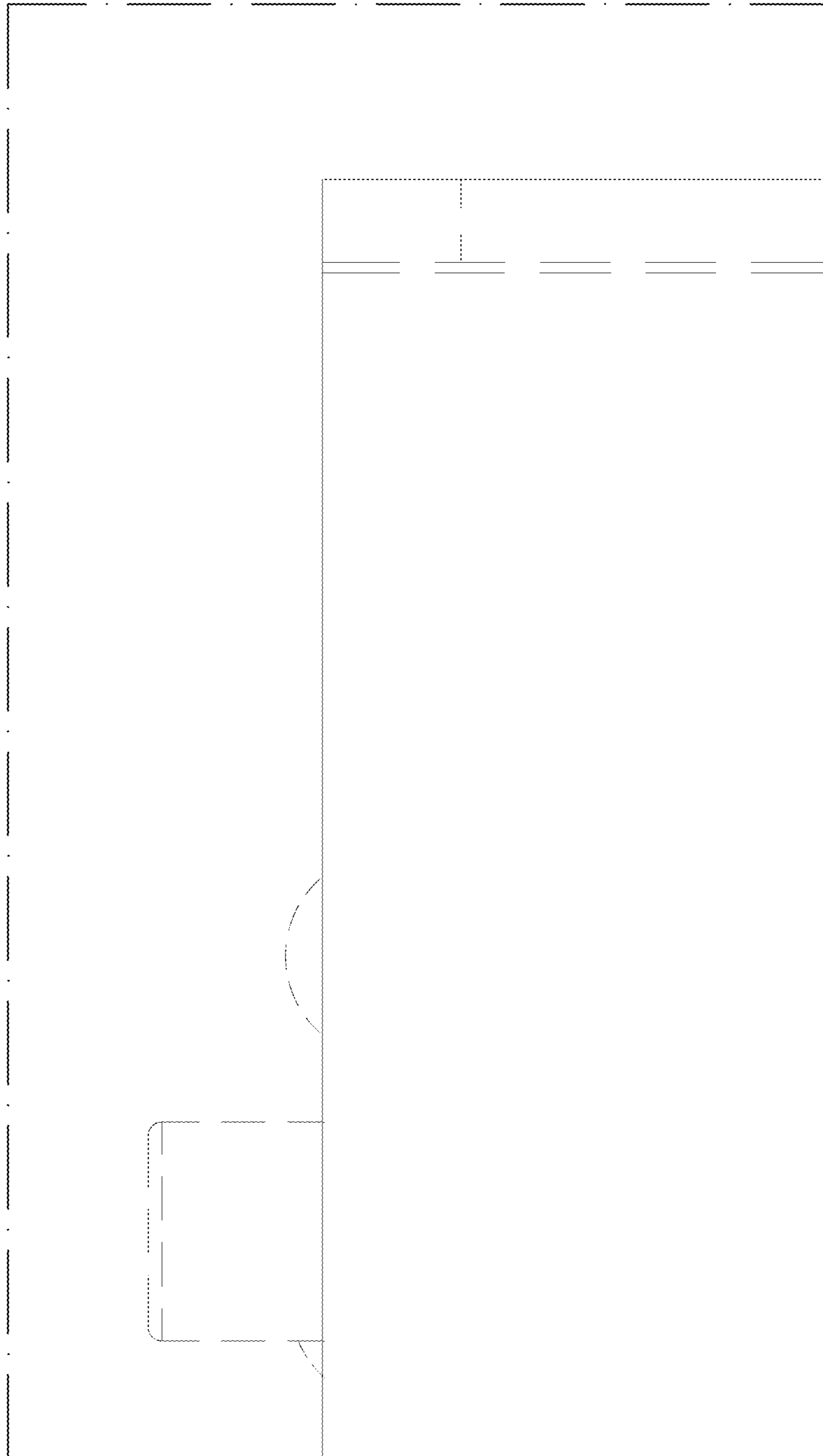

FIG. 38

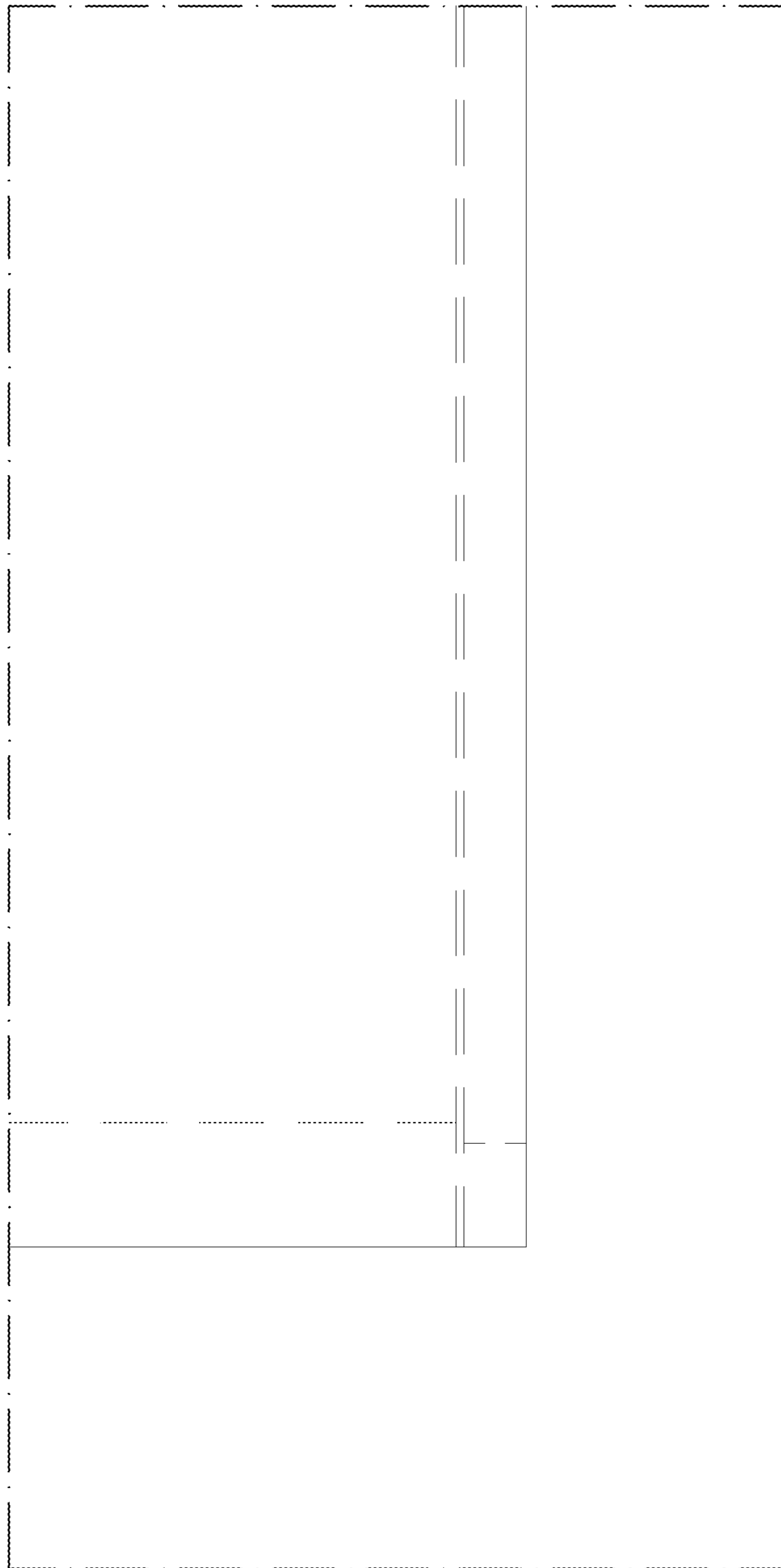

FIG. 39

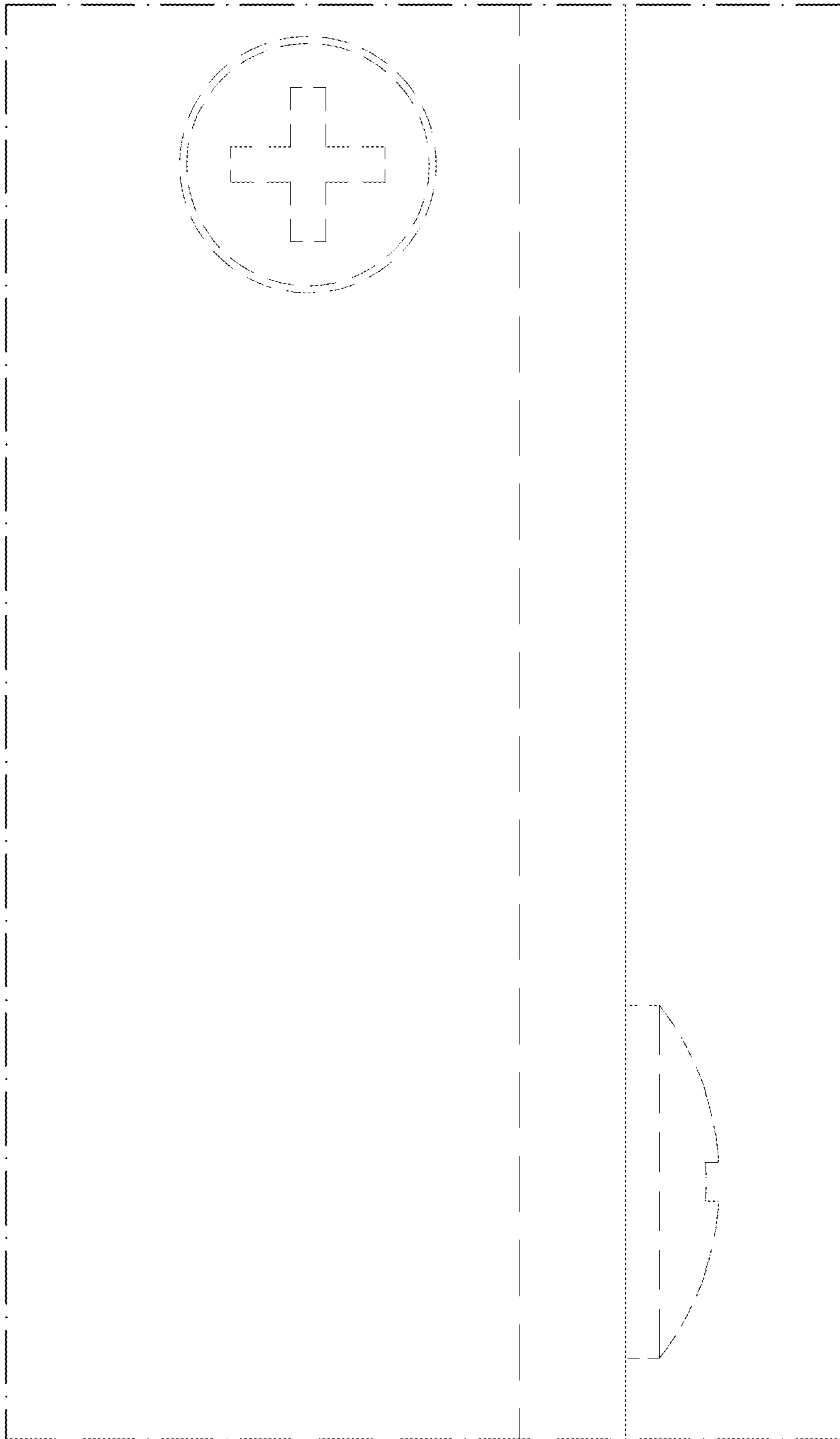

FIG. 40



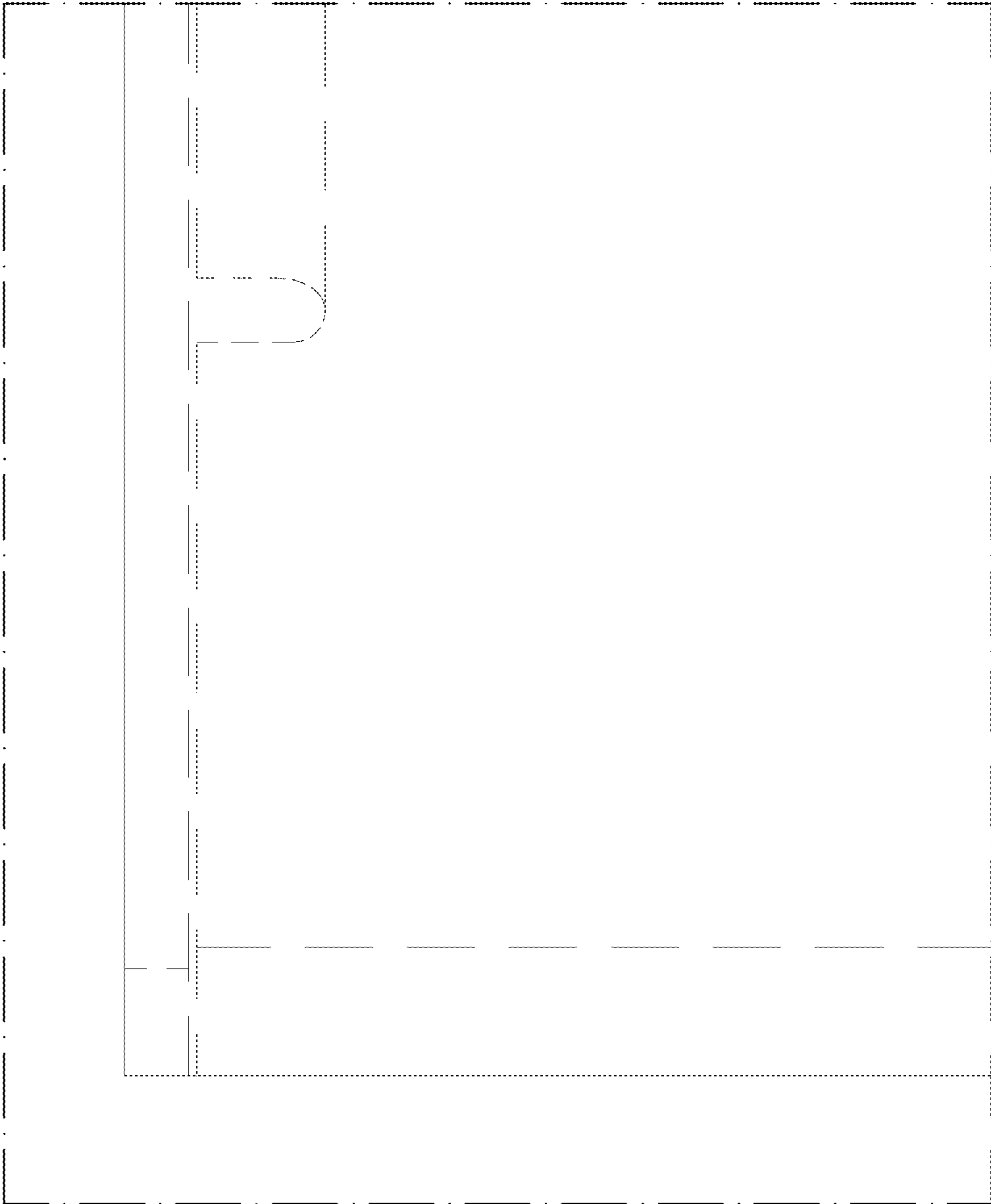

FIG. 41

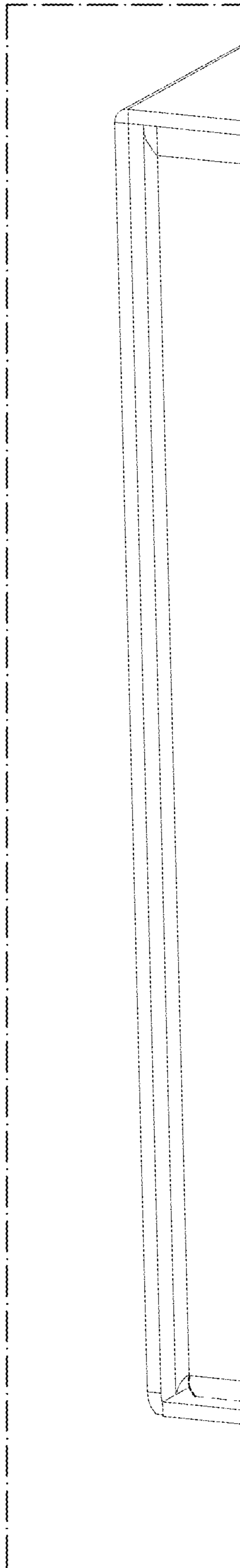

FIG. 42

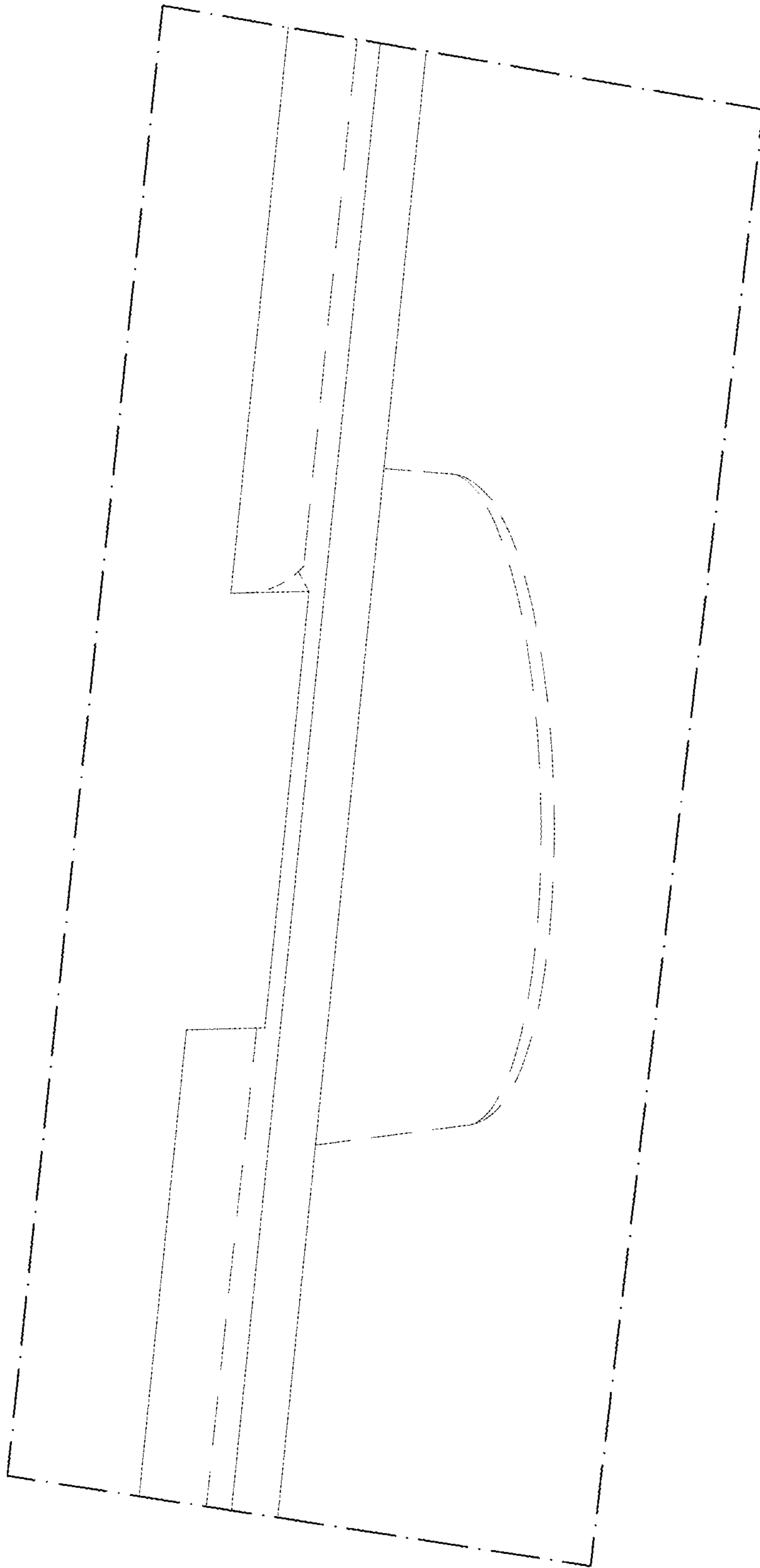

FIG. 43

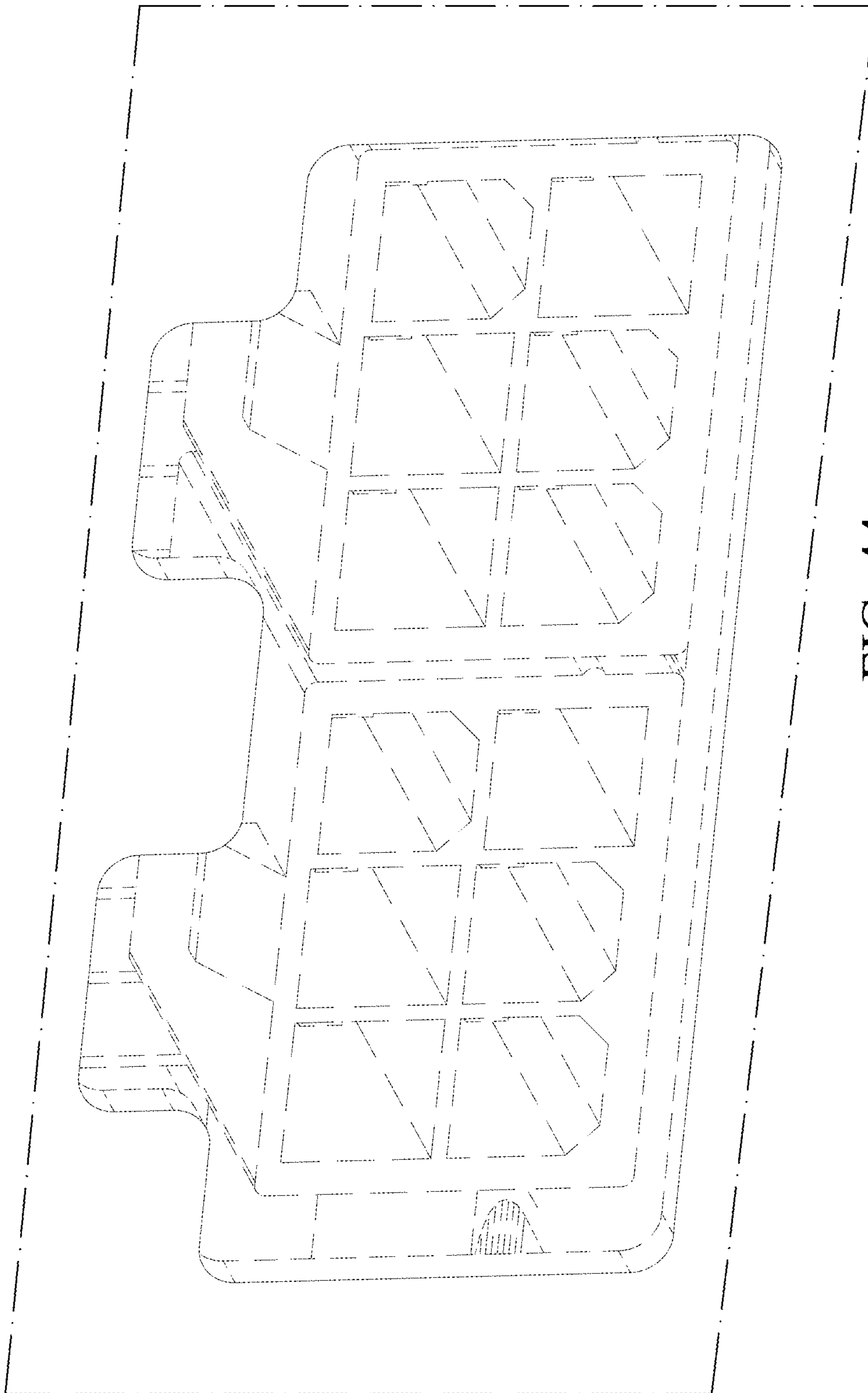

FIG. 44

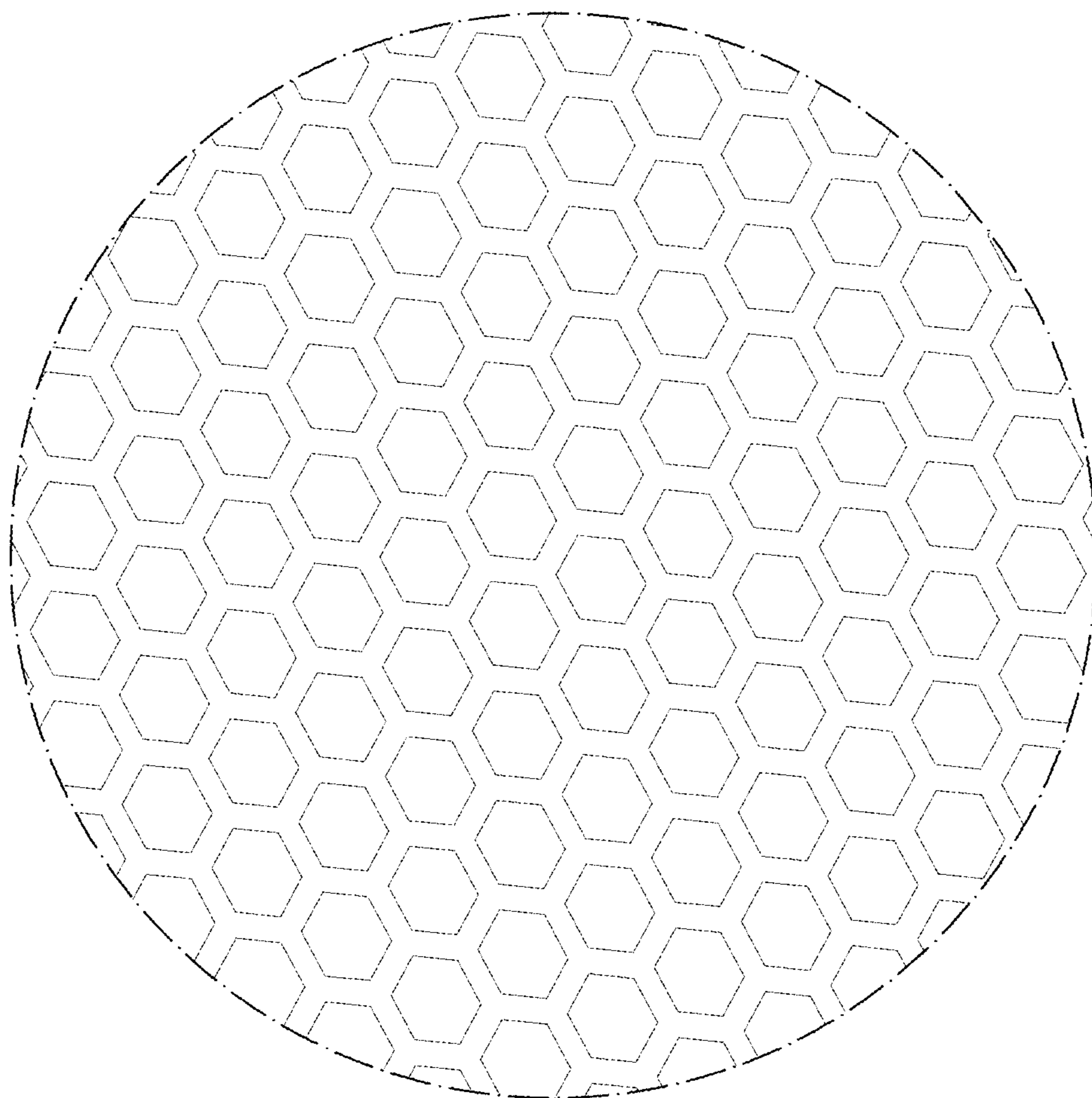

FIG. 45

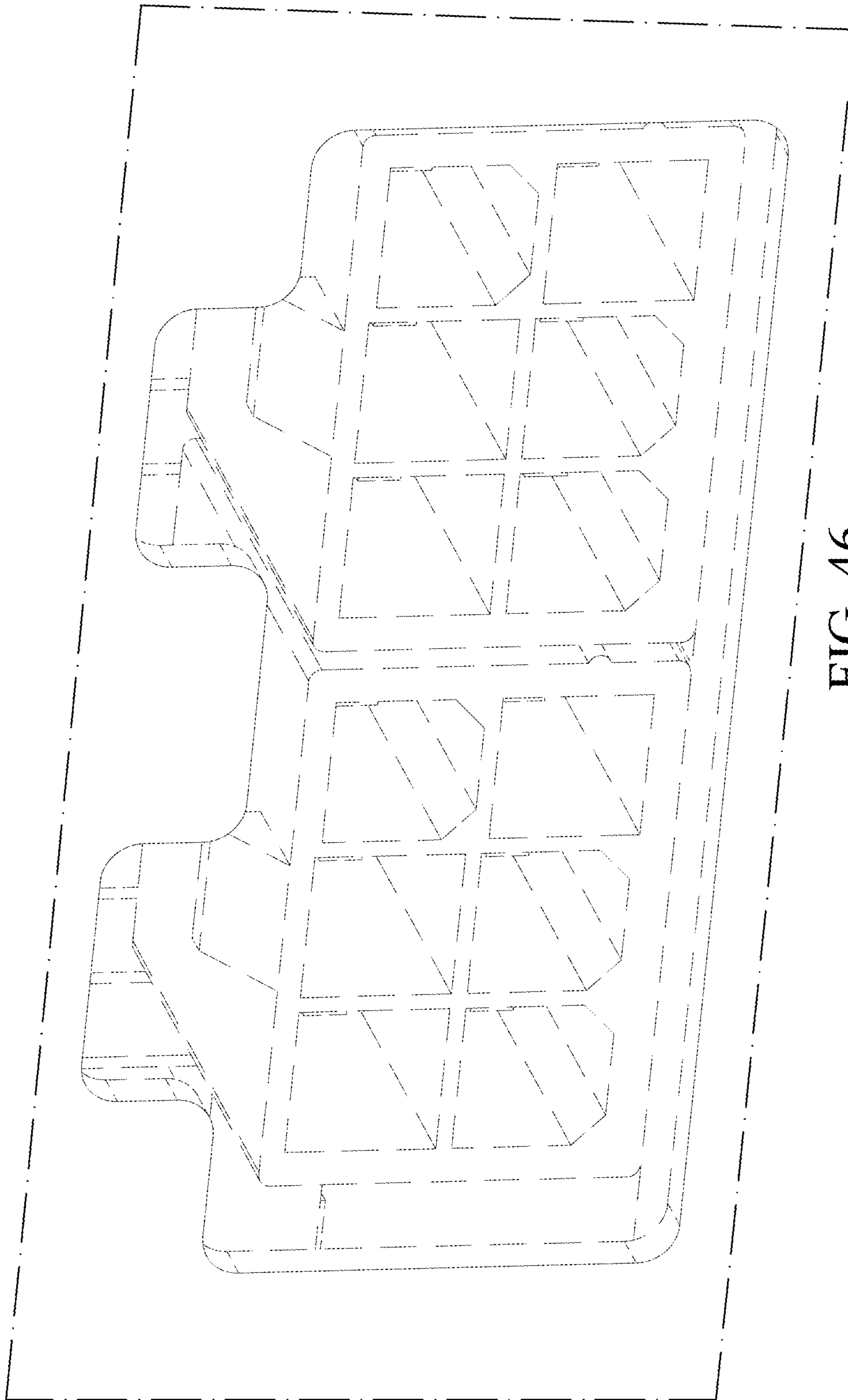

FIG. 46



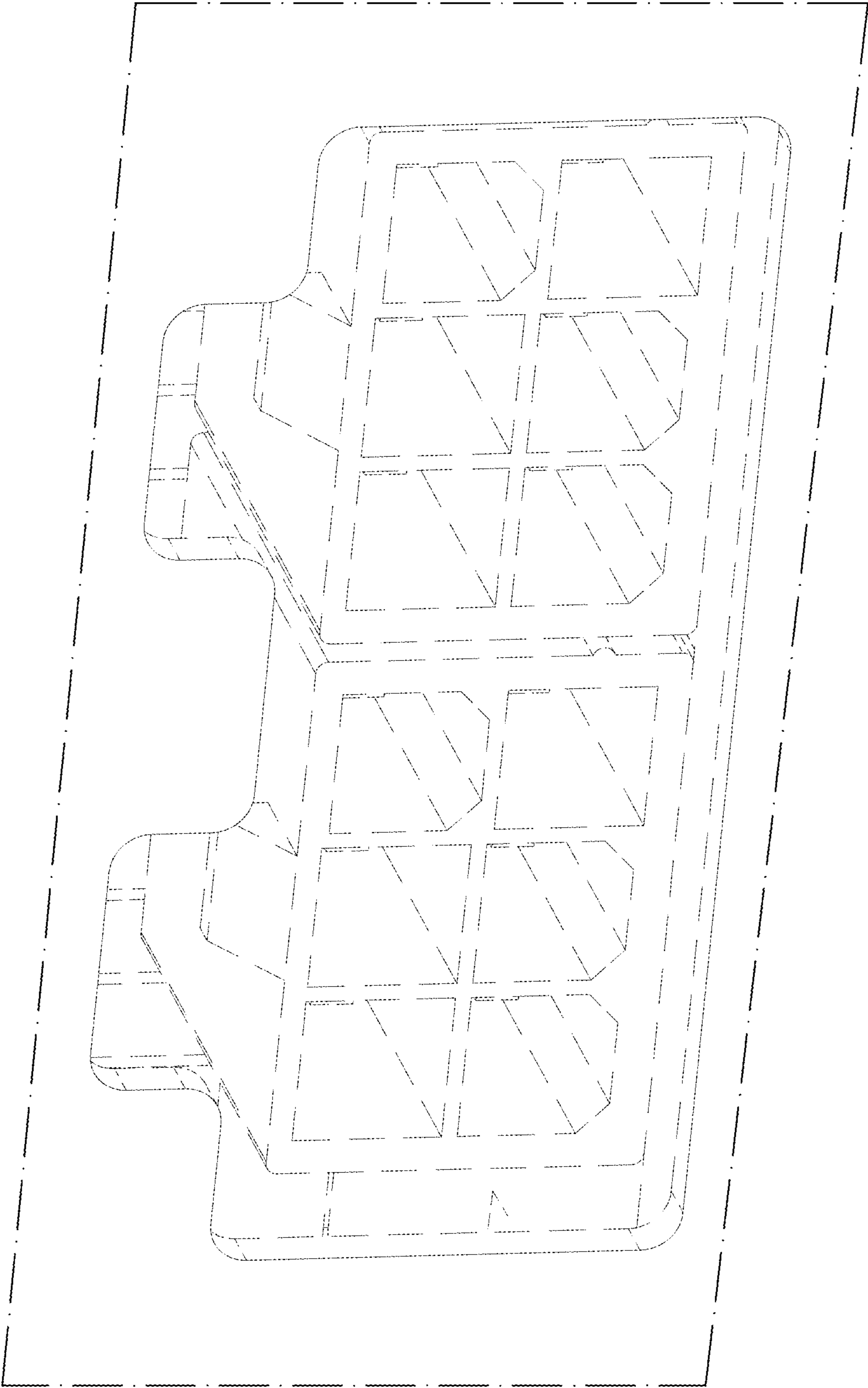

FIG. 47

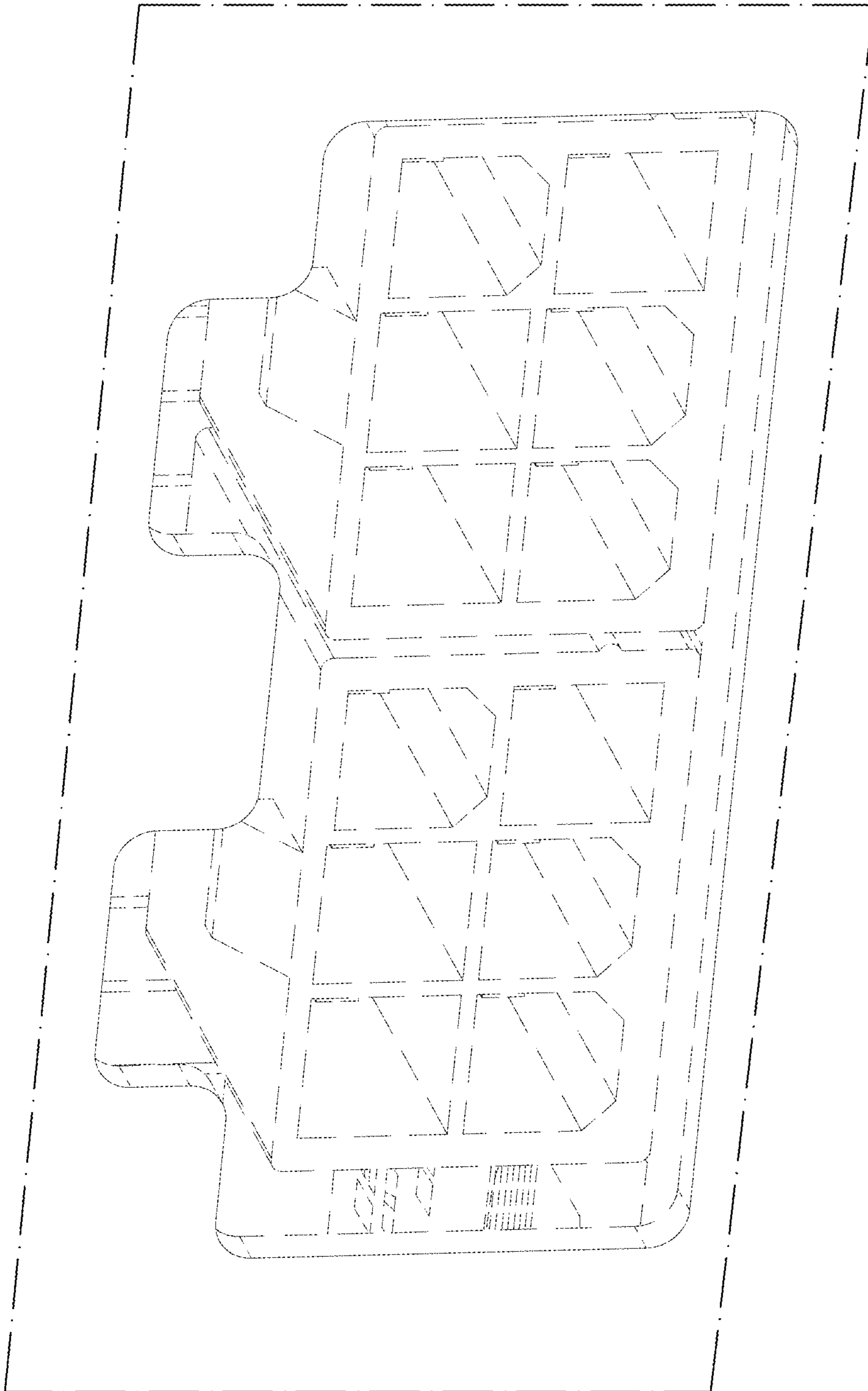

FIG. 48

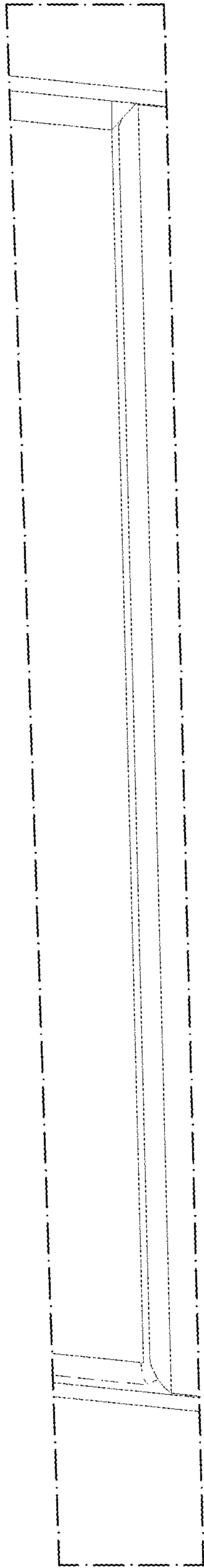

FIG. 49

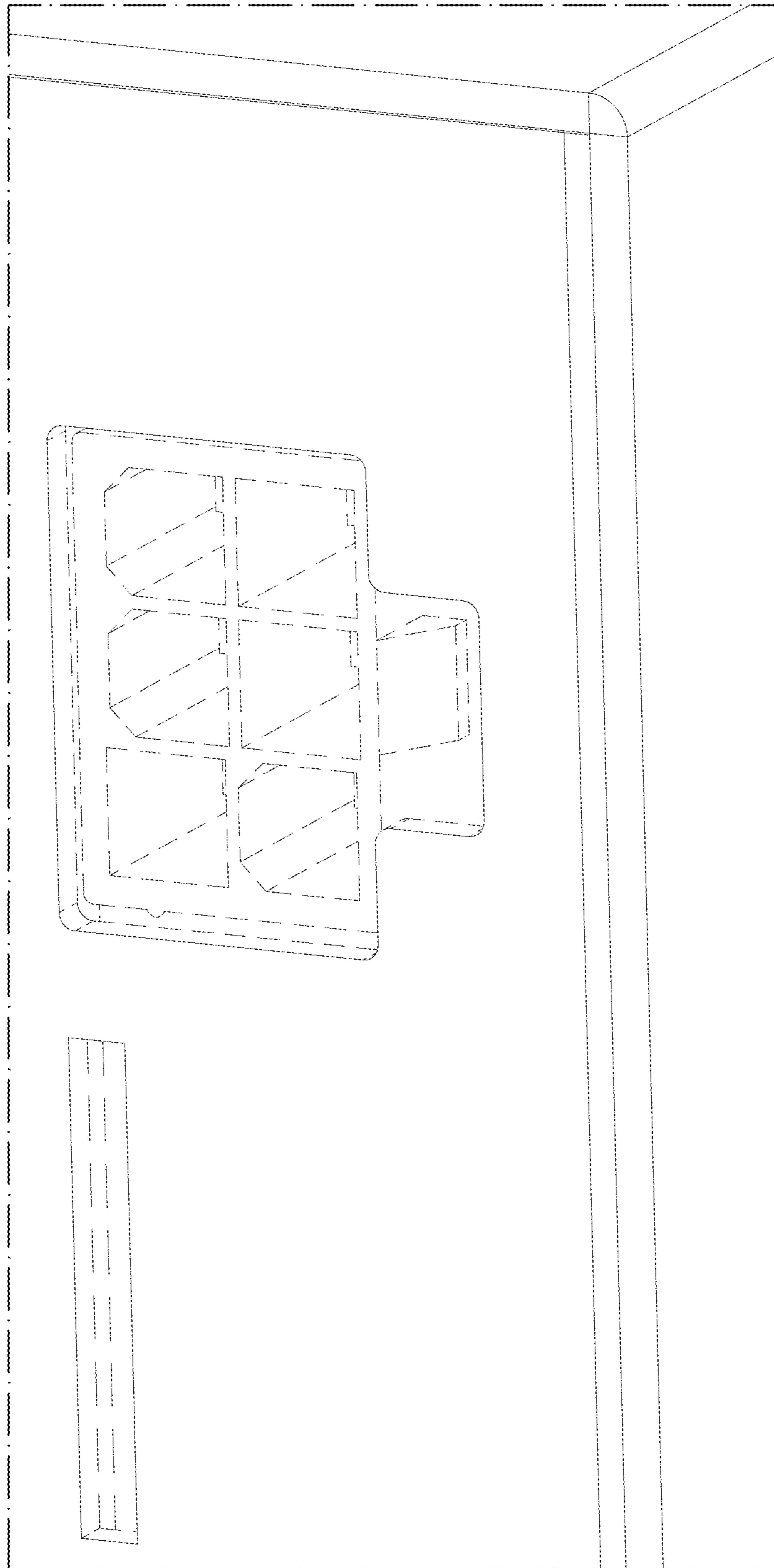

FIG. 50

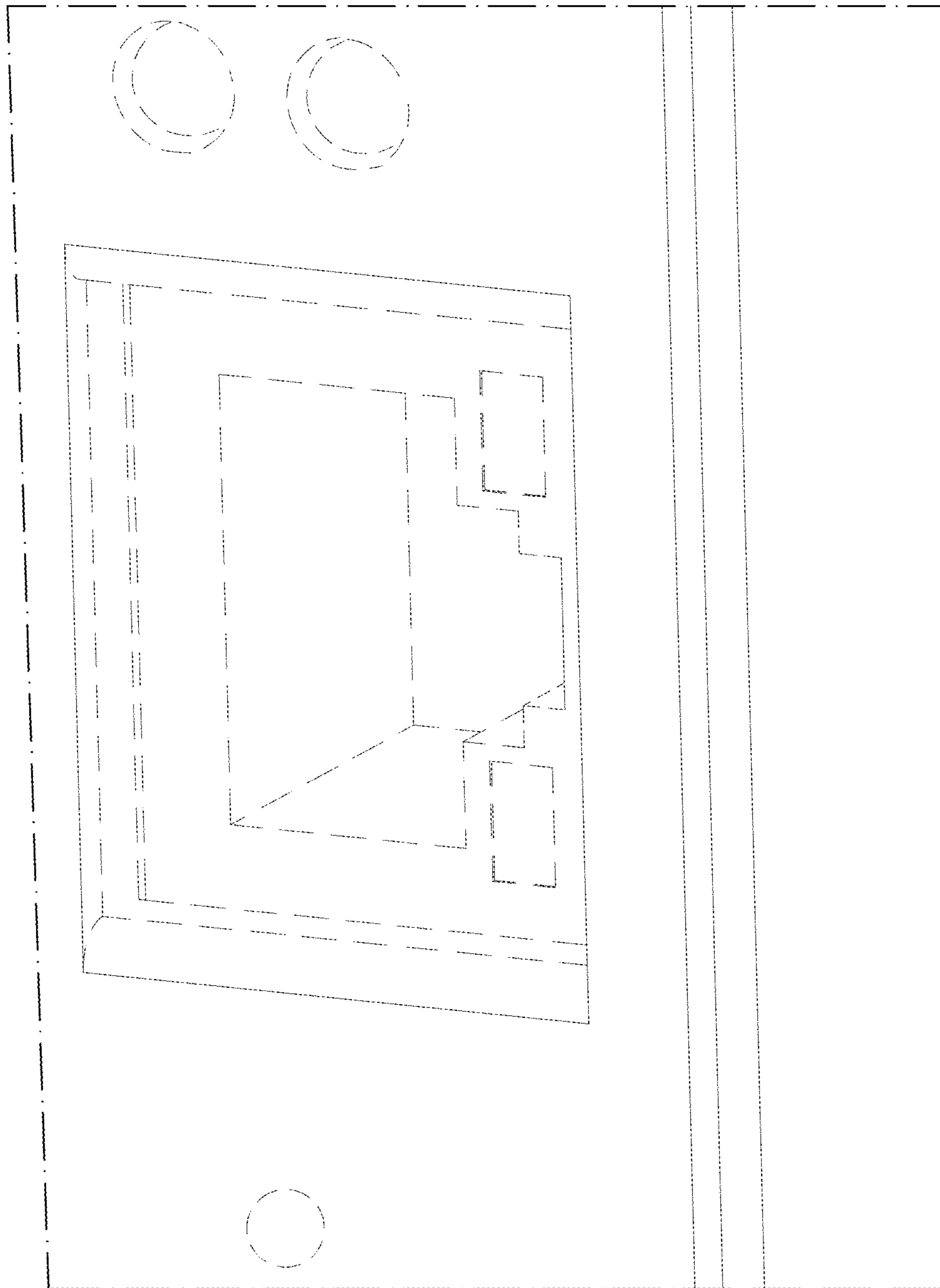

FIG. 51

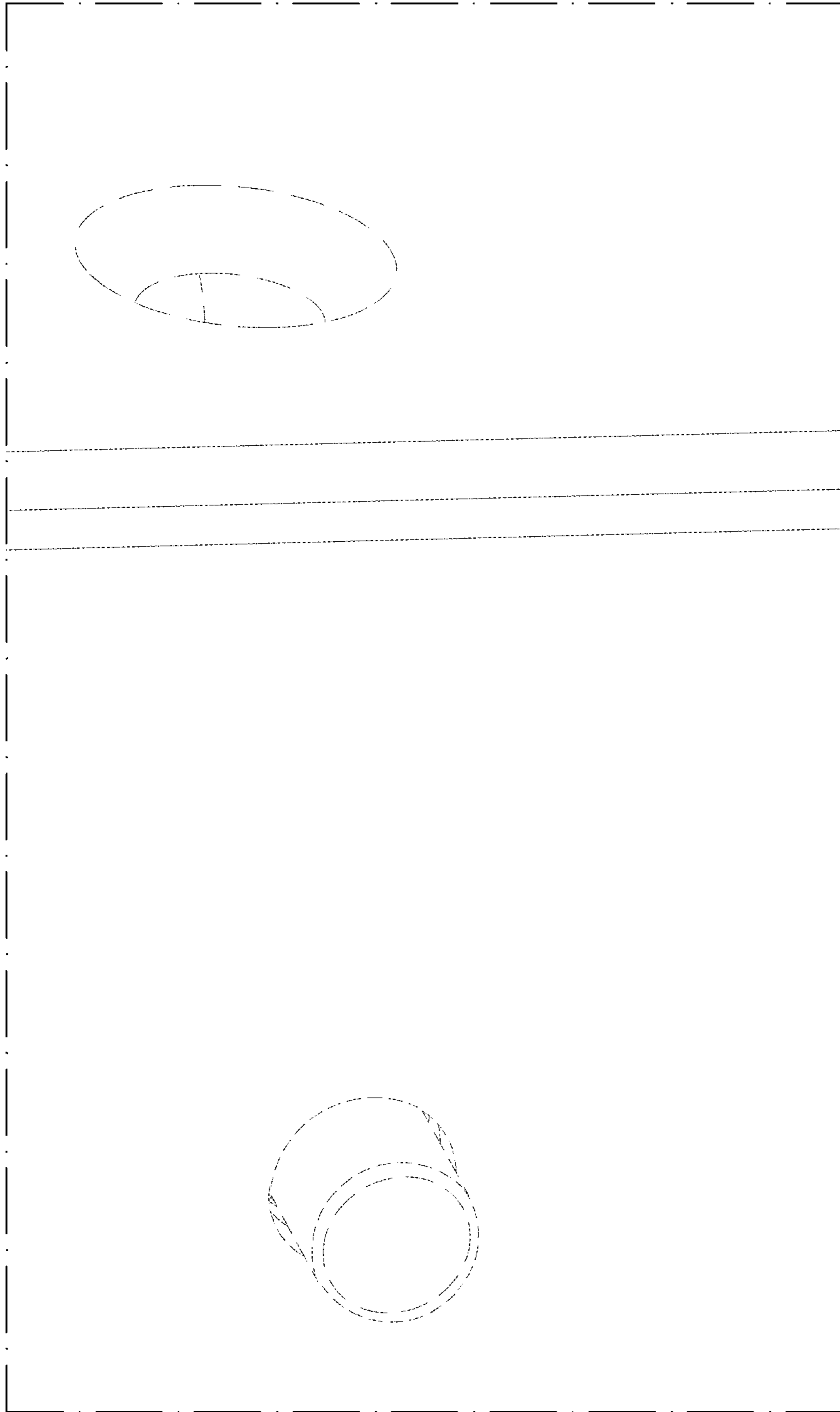

FIG. 52

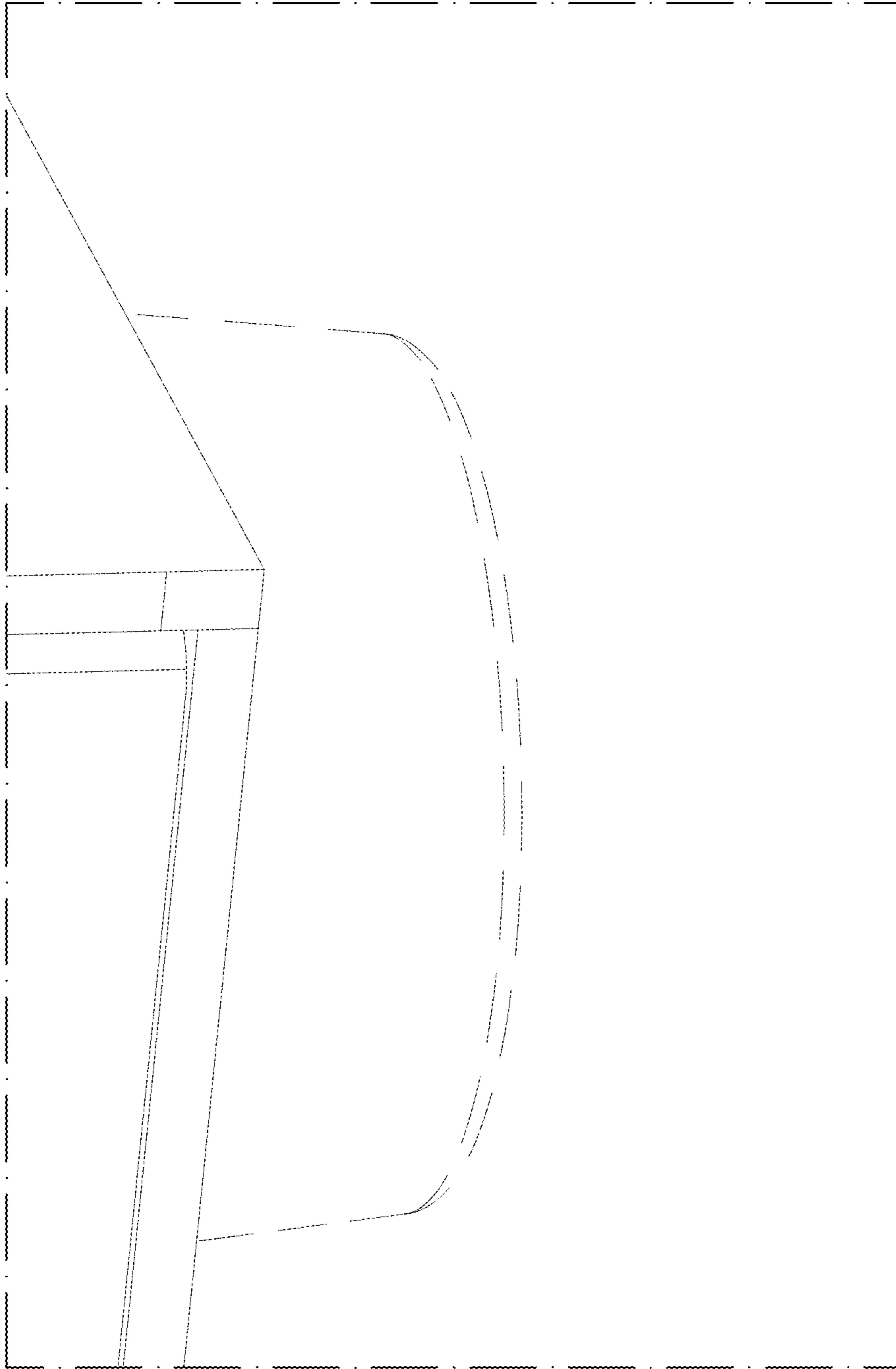

FIG. 53

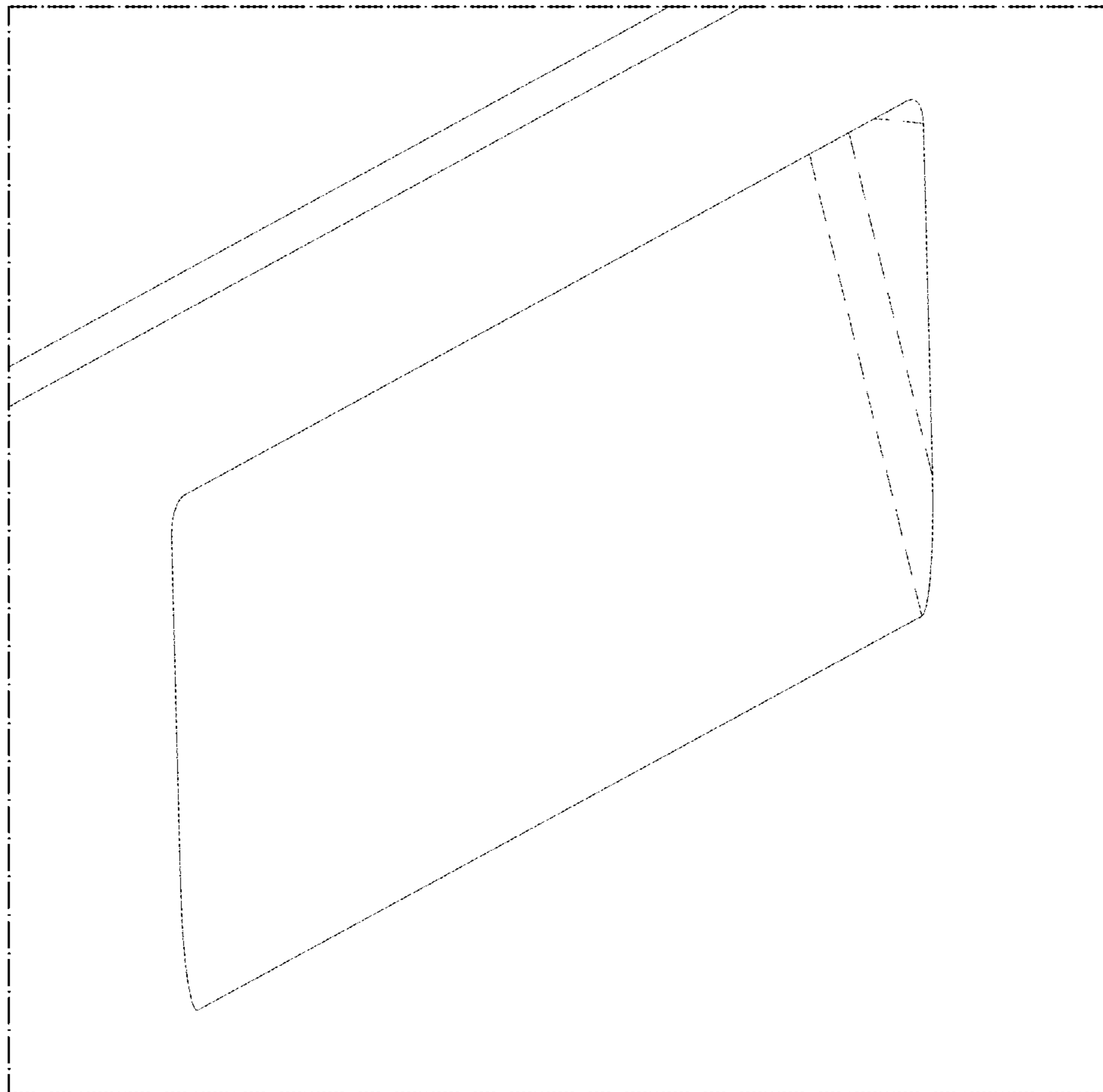

FIG. 54



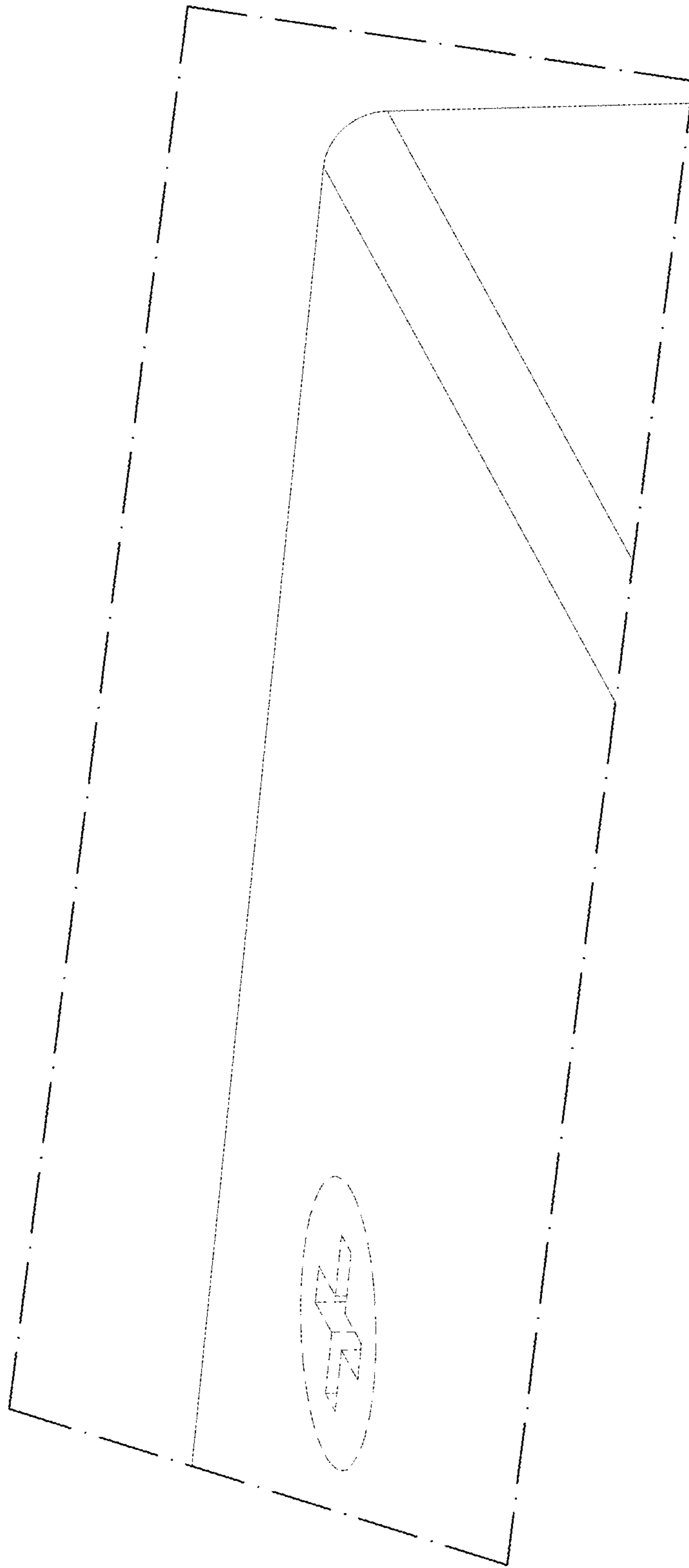

FIG. 55