

US00D964340S

(12) **United States Design Patent**  
**Lee**

(10) **Patent No.:** **US D964,340 S**  
(45) **Date of Patent:** **\*\* Sep. 20, 2022**

(54) **COVER FOR ELECTRONIC COMMUNICATIONS DEVICE**

**DESCRIPTION**

(71) Applicant: **ELAGO COMPANY CO., LTD.**,  
Goyang-si (KR)

(72) Inventor: **Chanwoo Lee**, Goyang-si (KR)

(73) Assignee: **ELAGO COMPANY CO., LTD.**,  
Goyang-si (KR)

(\*\*) Term: **15 Years**

(21) Appl. No.: **29/804,161**

(22) Filed: **Aug. 18, 2021**

(51) **LOC (13) Cl.** ..... **14-03**

(52) **U.S. Cl.**  
USPC ..... **D14/250**

(58) **Field of Classification Search**  
USPC ..... D14/203.3–203.7, 439, 447, 251–253,  
D14/217, 240, 238.1, 440, 248, 250;  
(Continued)

(56) **References Cited**

**U.S. PATENT DOCUMENTS**

D624,910 S \* 10/2010 Richardson ..... D14/250  
8,430,240 B2 \* 4/2013 Kim ..... G06F 1/1626  
455/575.8

(Continued)

**FOREIGN PATENT DOCUMENTS**

CN 305805843 5/2020  
CN 305863643 6/2020

(Continued)

*Primary Examiner* — Carla J Wright

(74) *Attorney, Agent, or Firm* — Paratus Law Group,  
PLLC

(57) **CLAIM**

The ornamental design for a cover for electronic communications device, as shown and described.

FIG. 1 is a front, top, and right side perspective view of a cover for electronic communications device, showing a first embodiment of my new design;

FIG. 2 is a front view of the first embodiment;

FIG. 3 is a back view of the first embodiment;

FIG. 4 is a left side view of the first embodiment;

FIG. 5 is a right side view of the first embodiment;

FIG. 6 is a top view of the first embodiment;

FIG. 7 is a bottom view of the first embodiment;

FIG. 8 is a front, top, and left side perspective view of the first embodiment;

FIG. 9 is a back, top, and left side perspective view of the first embodiment;

FIG. 10 is a back, bottom, and right side perspective view of the first embodiment;

FIG. 11 is a front, top, and right side perspective view of a cover for electronic communications device, showing a second embodiment of my new design;

FIG. 12 is a front view of the second embodiment;

FIG. 13 is a back view of the second embodiment;

FIG. 14 is a left side view of the second embodiment;

FIG. 15 is a right side view of the second embodiment;

FIG. 16 is a top view of the second embodiment;

FIG. 17 is a bottom view of the second embodiment;

FIG. 18 is a front, top, and left side perspective view of the second embodiment;

FIG. 19 is a back, top, and left side perspective view of the second embodiment;

FIG. 20 is a back, bottom, and right side perspective view of the second embodiment;

FIG. 21 is a front, top, and right side perspective view of a cover for electronic communications device, showing a third embodiment of my new design;

FIG. 22 is a front view of the third embodiment;

FIG. 23 is a back view of the third embodiment;

FIG. 24 is a left side view of the third embodiment;

FIG. 25 is a right side view of the third embodiment;

FIG. 26 is a top view of the third embodiment;

FIG. 27 is a bottom view of the third embodiment;

FIG. 28 is a front, top, and left side perspective view of the third embodiment;

(Continued)

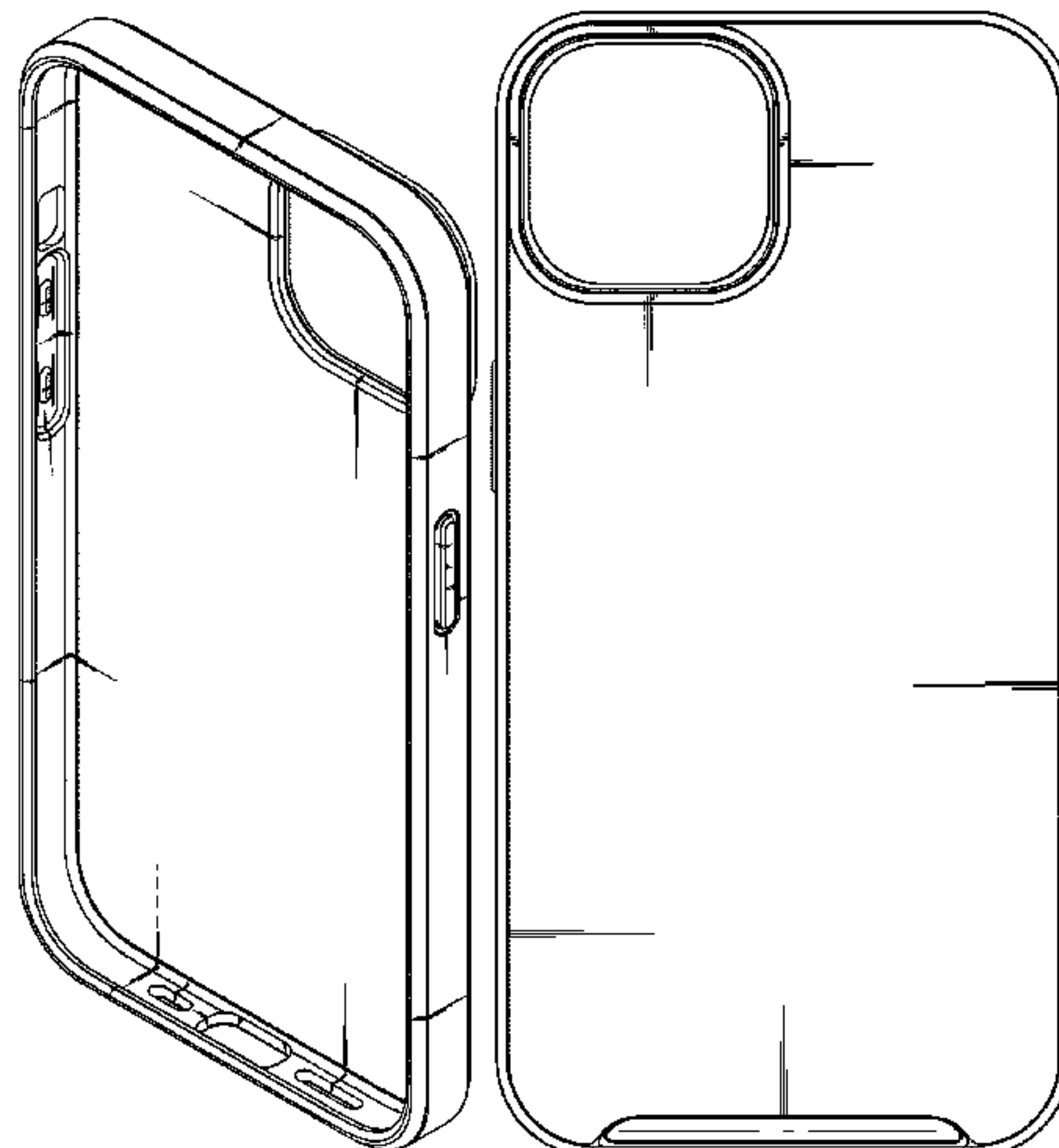

FIG. 29 is a back, top, and left side perspective view of the third embodiment;  
 FIG. 30 is a back, bottom, and right side perspective view of the third embodiment;  
 FIG. 31 is a front, top, and right side perspective view of a cover for electronic communications device, showing a fourth embodiment of my new design;  
 FIG. 32 is a front view of the fourth embodiment;  
 FIG. 33 is a back view of the fourth embodiment;  
 FIG. 34 is a left side view of the fourth embodiment;  
 FIG. 35 is a right side view of the fourth embodiment;  
 FIG. 36 is a top view of the fourth embodiment;  
 FIG. 37 is a bottom view of the fourth embodiment;  
 FIG. 38 is a front, top, and left side perspective view of the fourth embodiment;  
 FIG. 39 is a back, top, and left side perspective view of the fourth embodiment; and,  
 FIG. 40 is a back, bottom, and right side perspective view of the fourth embodiment.

**1 Claim, 32 Drawing Sheets**

(58) **Field of Classification Search**

USPC ..... D13/103, 107-108, 119; D3/201, 218, D3/247, 249, 269, 273, 301, 303, 294  
 CPC ..... H04B 1/3888; A45C 13/02; A45C 11/00; A45C 2011/002; A45C 1/06; A45F 2200/0525; A45F 2005/026; A45F 2200/0516; H04M 1/0283; H04M 1/0202  
 See application file for complete search history.

(56) **References Cited**

U.S. PATENT DOCUMENTS

D696,239 S \* 12/2013 Murchison ..... D14/250  
 D714,276 S 9/2014 Hu et al.

D740,798 S 10/2015 Poon et al.  
 D772,210 S 11/2016 Igarashi  
 D773,445 S \* 12/2016 Witter ..... D14/250  
 D775,614 S \* 1/2017 Kim ..... D14/250  
 D779,471 S 2/2017 Tien  
 D796,498 S \* 9/2017 Babichenko ..... D14/250  
 D800,105 S 10/2017 Roberts et al.  
 D807,868 S 1/2018 Wang  
 D822,652 S \* 7/2018 Kim ..... D14/250  
 D845,292 S \* 4/2019 Fitzgerald ..... D14/250  
 D855,046 S \* 7/2019 Wei ..... D14/250  
 10,362,847 B1 \* 7/2019 Okada ..... H04B 1/3888  
 D856,996 S \* 8/2019 Kim ..... D14/250  
 D860,185 S \* 9/2019 Kim ..... D14/250  
 D868,764 S \* 12/2019 Ahn ..... D14/250  
 D894,886 S 9/2020 Kim  
 D898,015 S \* 10/2020 Kwak ..... D14/250  
 D898,724 S \* 10/2020 Kim ..... D14/250  
 D902,913 S \* 11/2020 Lee ..... D14/250  
 D903,647 S \* 12/2020 Lin ..... D14/250  
 D905,680 S 12/2020 Kim  
 D909,359 S 2/2021 Kim  
 D912,035 S \* 3/2021 Lee ..... D14/250  
 D913,270 S \* 3/2021 Lee ..... D14/250  
 D915,377 S \* 4/2021 Kim ..... D14/250  
 D917,451 S 4/2021 Ng  
 D918,888 S \* 5/2021 Feng ..... D14/250  
 D929,984 S \* 9/2021 Wu ..... D14/250  
 2013/0257240 A1 \* 10/2013 Hong ..... H04B 1/3888  
 312/223.1  
 2014/0221056 A1 \* 8/2014 Gandhi ..... H04B 1/3888  
 455/575.8

FOREIGN PATENT DOCUMENTS

CN 305863645 6/2020  
 CN 305891440 7/2020  
 KR 10-2116885 B1 6/2020

\* cited by examiner

FIG. 1

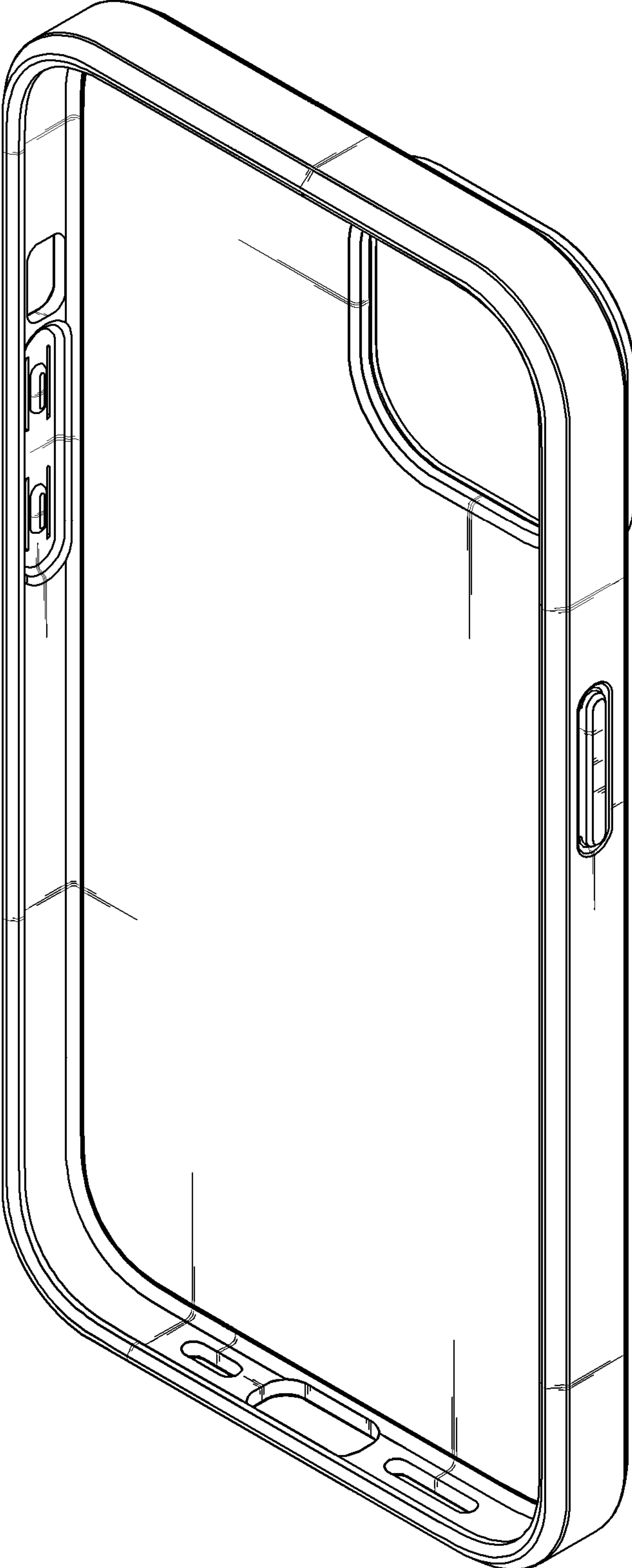

FIG. 2

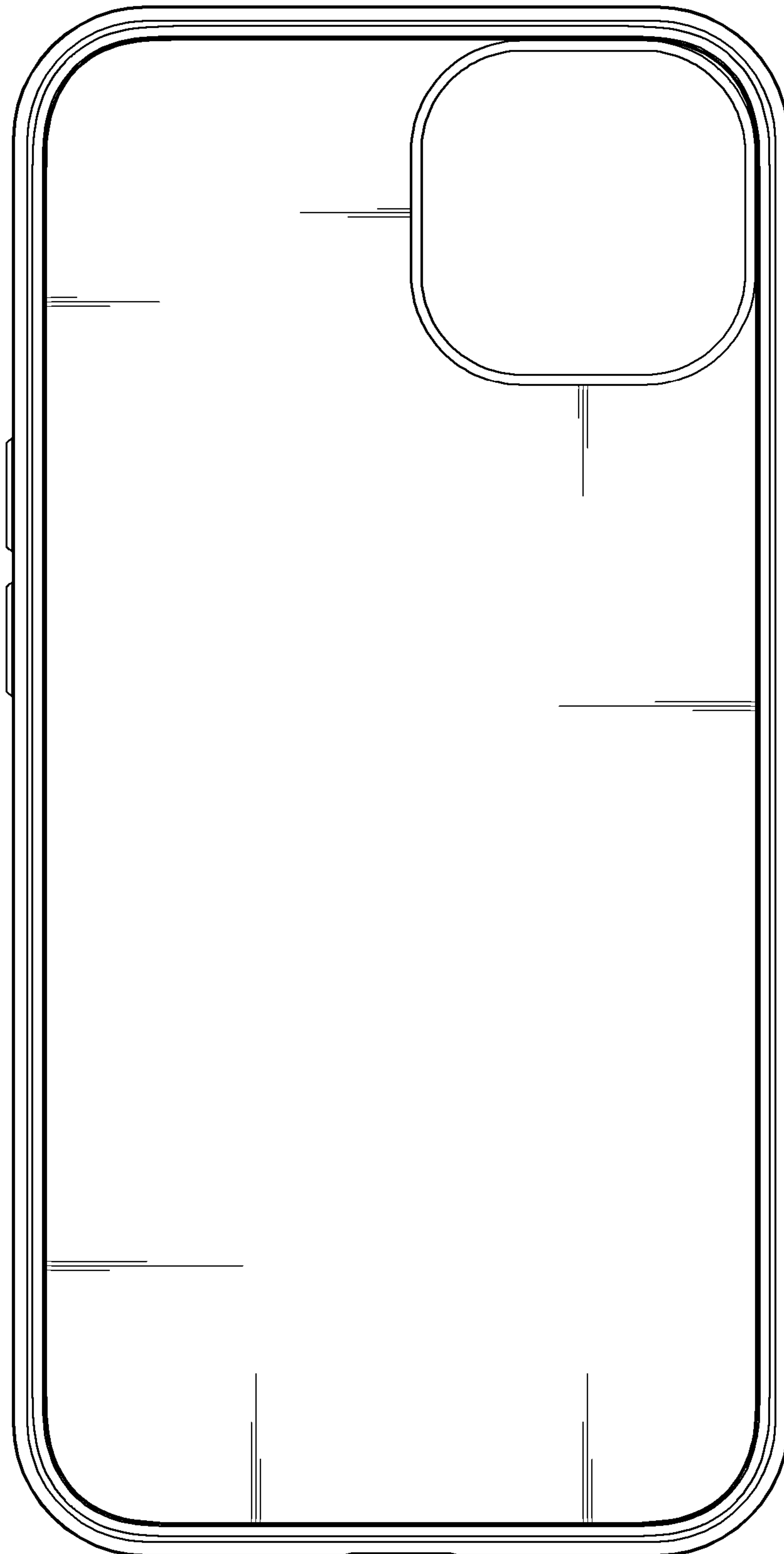



FIG. 3

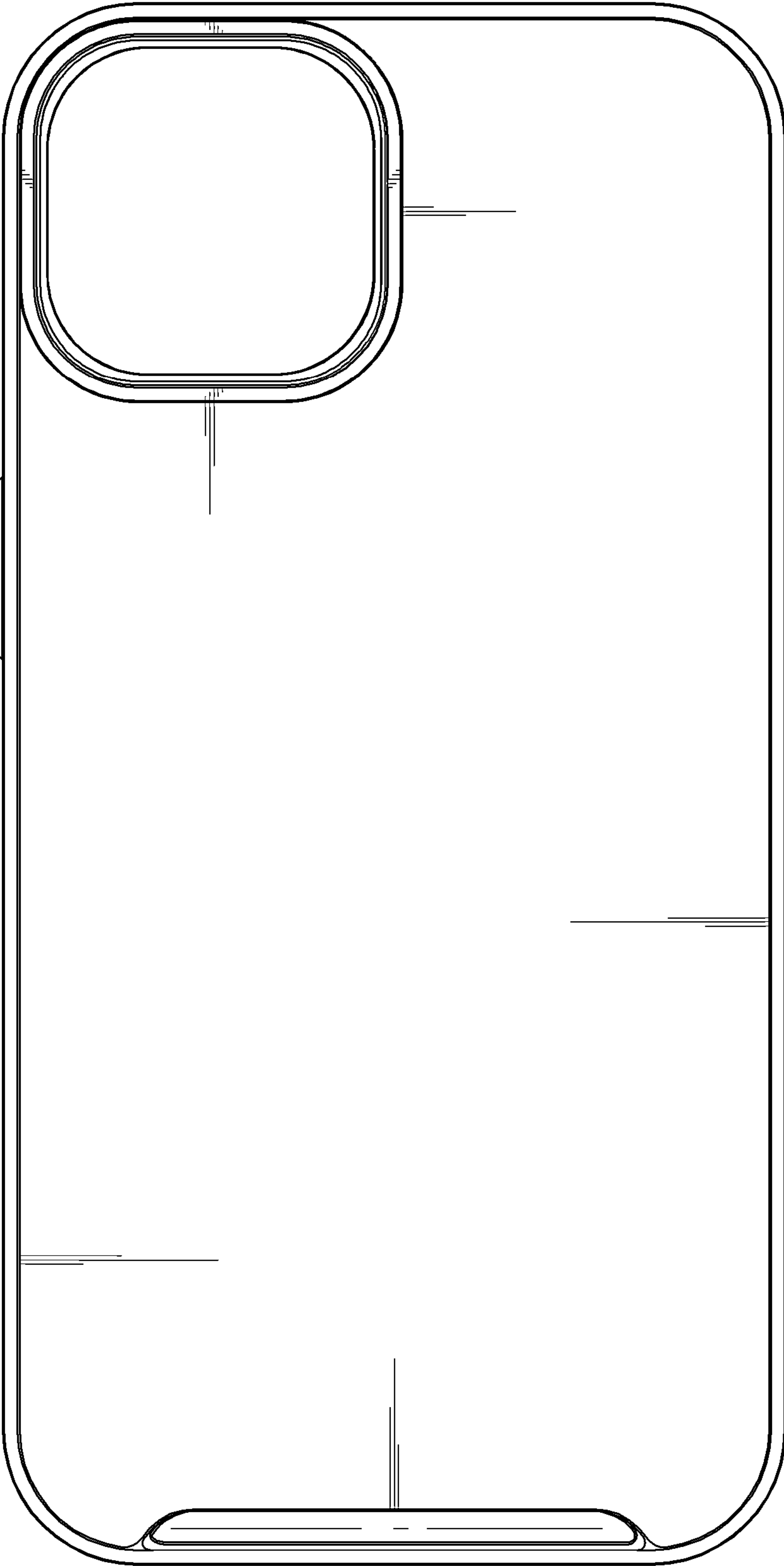

FIG. 4

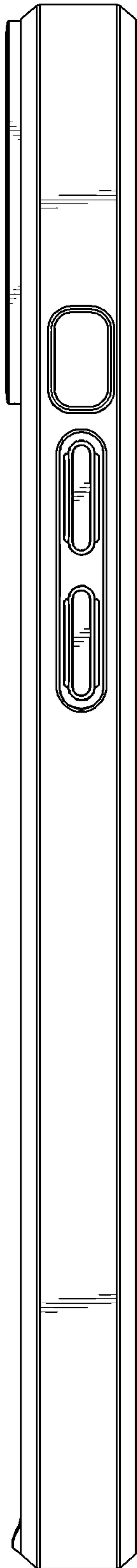

FIG. 5

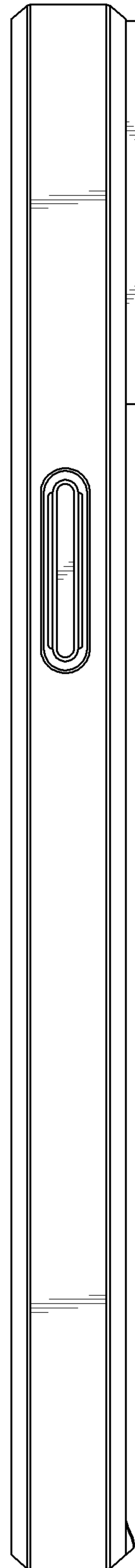

FIG. 6

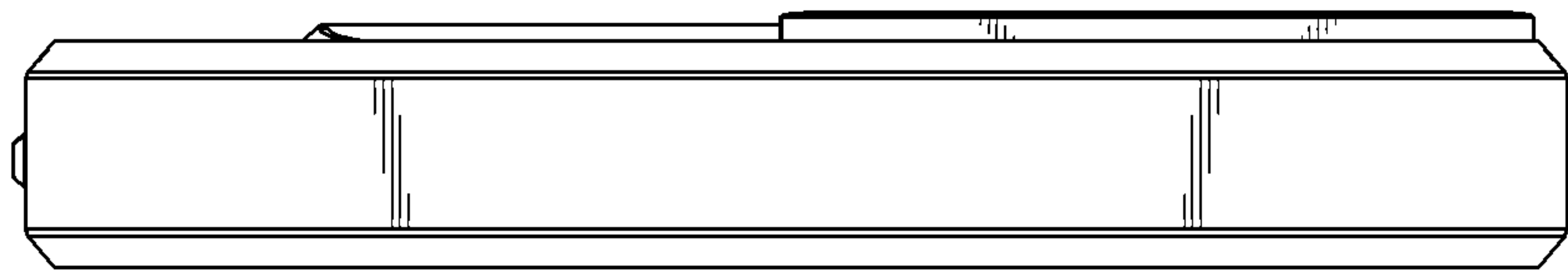

FIG. 7

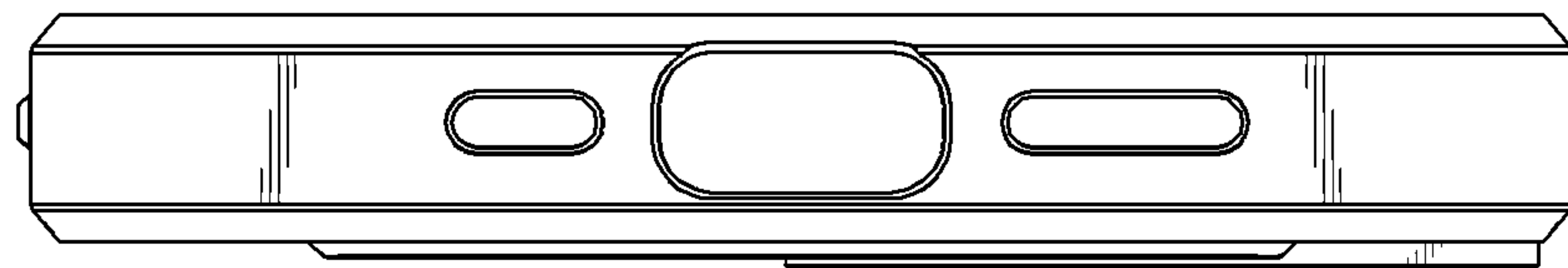

FIG. 8

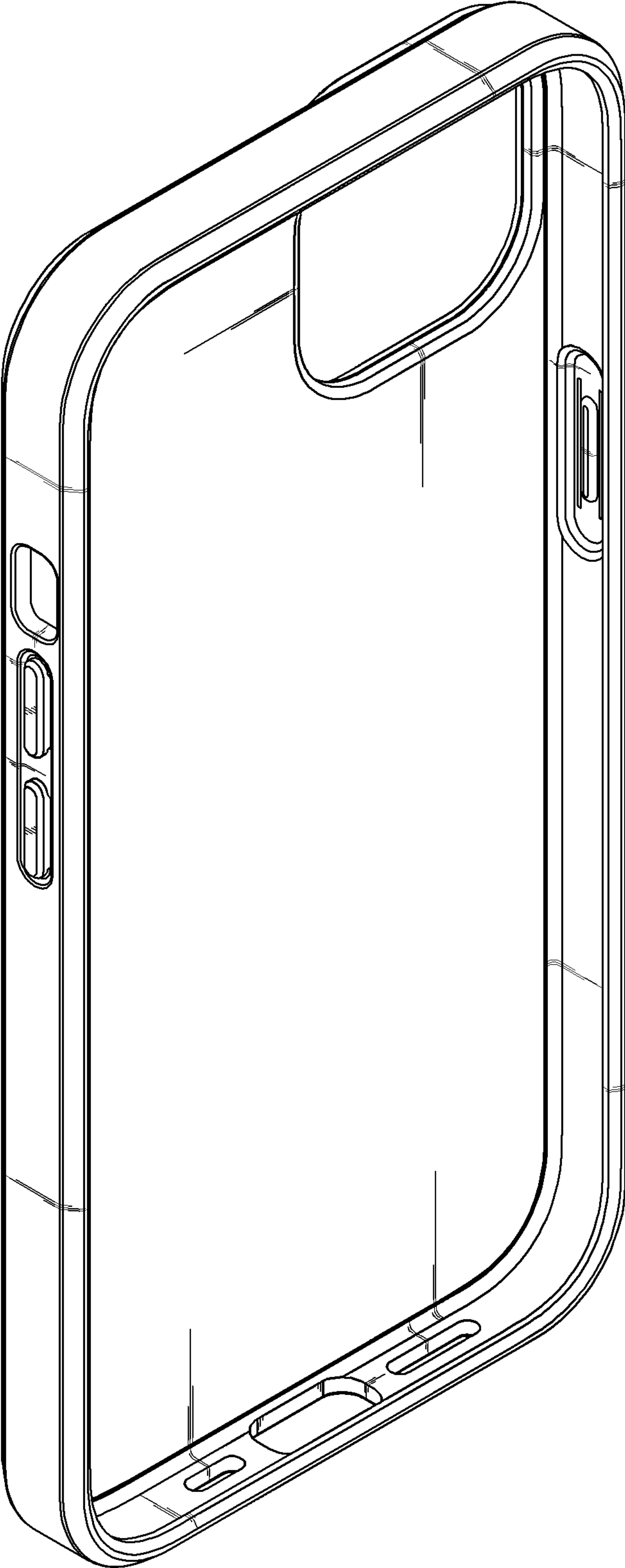



FIG. 9

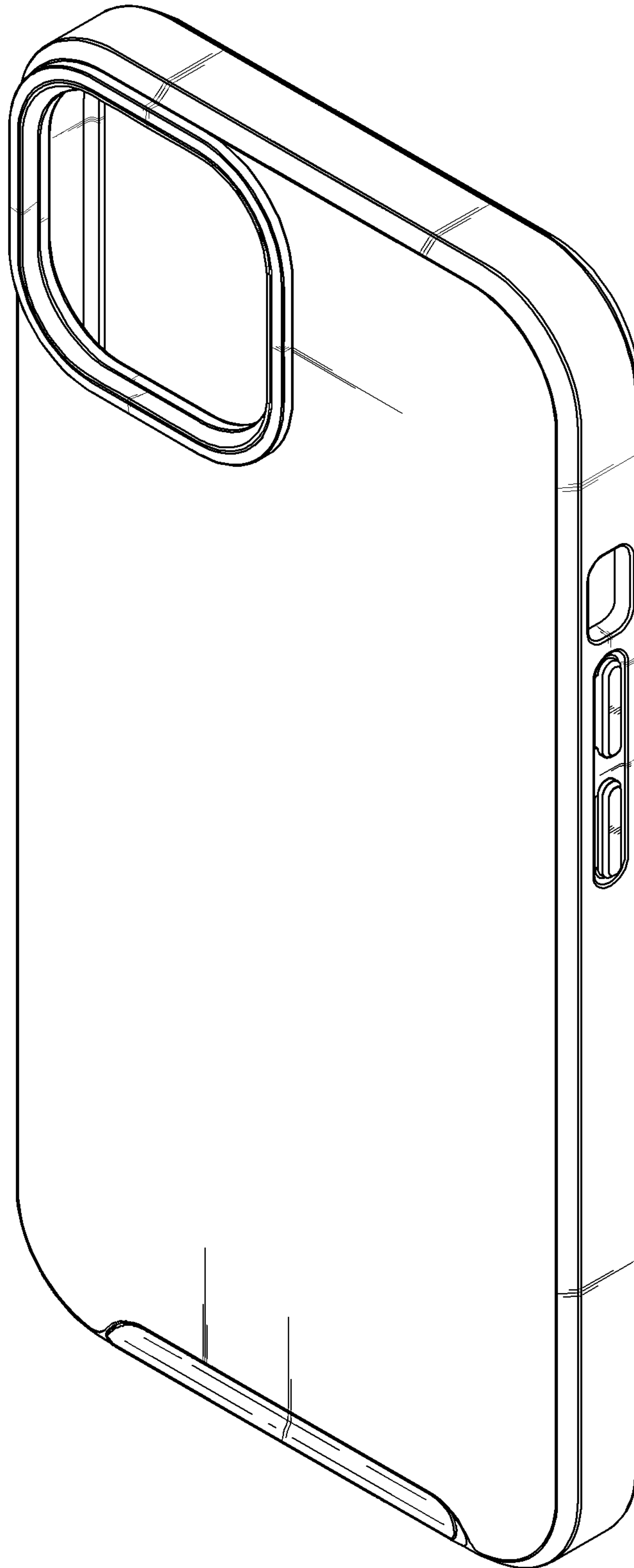

FIG. 10

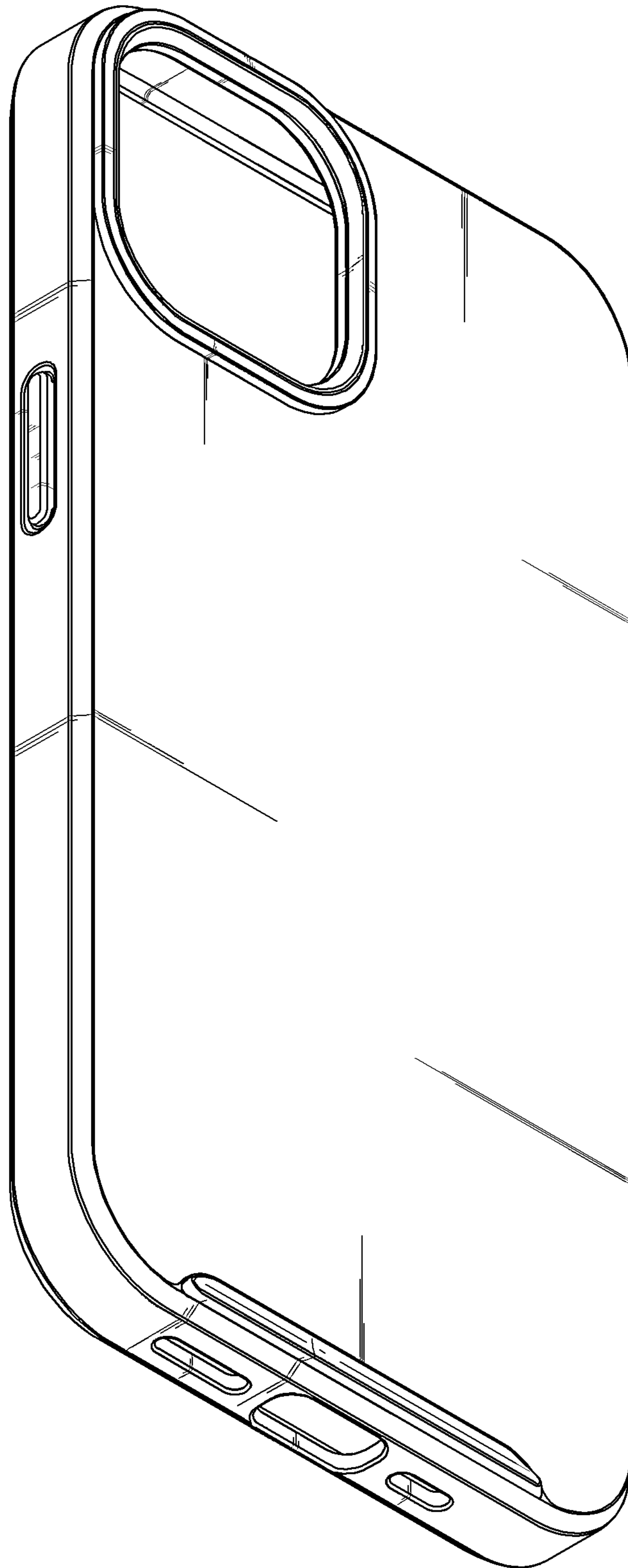

FIG. 11

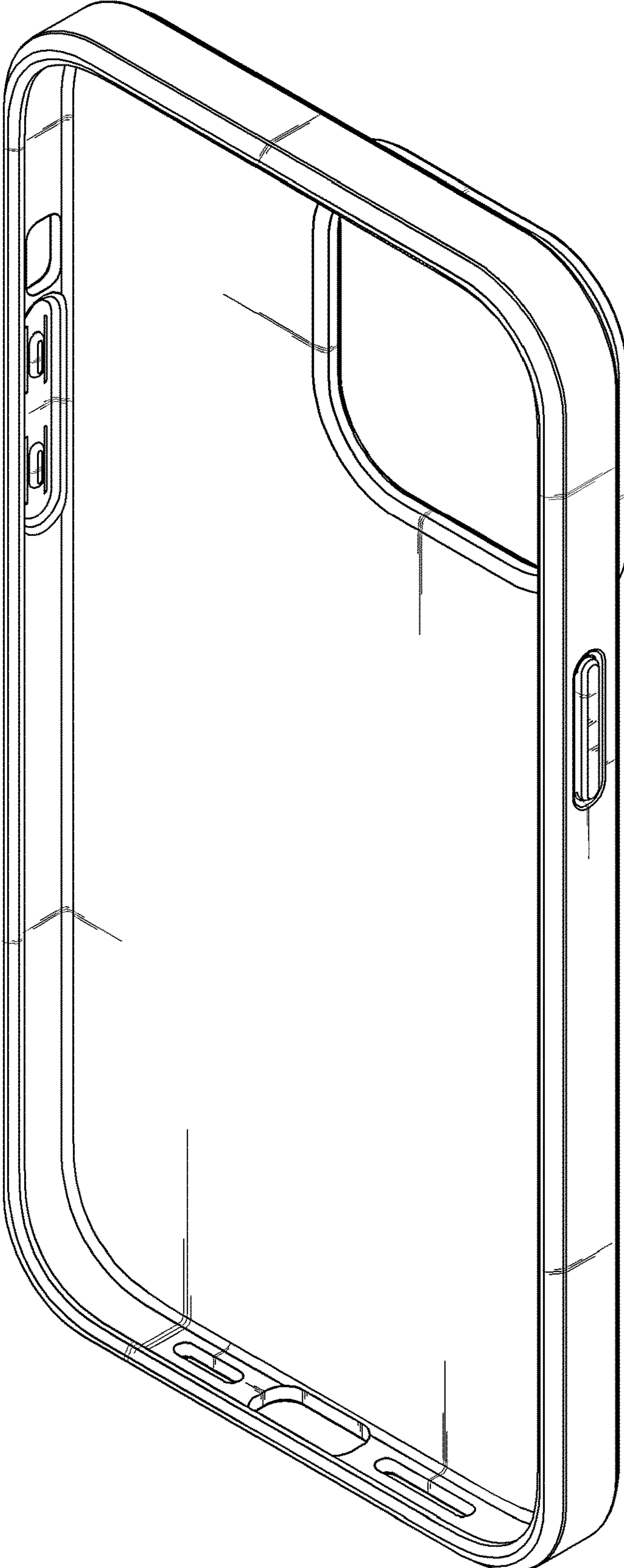

FIG. 12

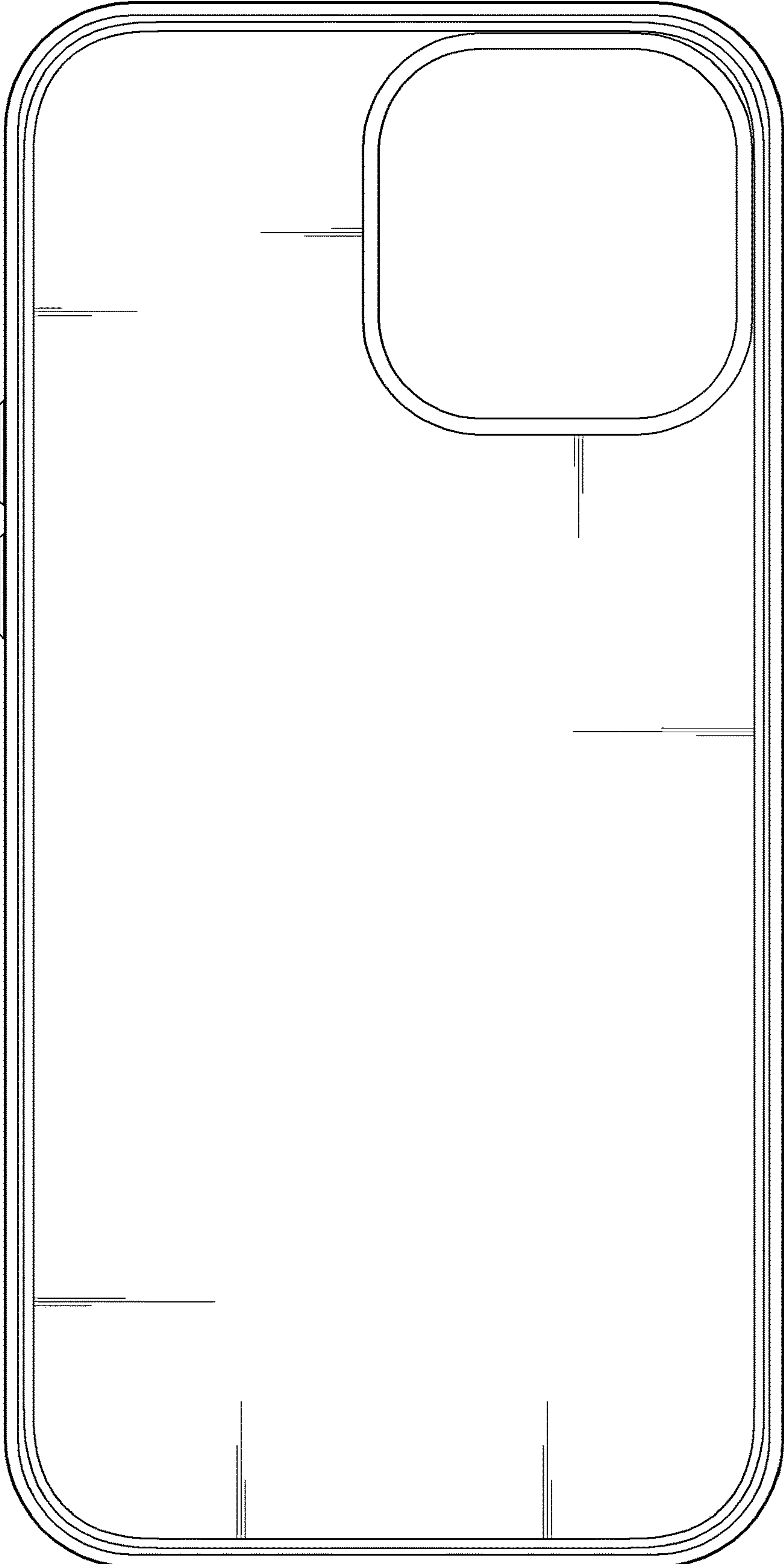

FIG. 13

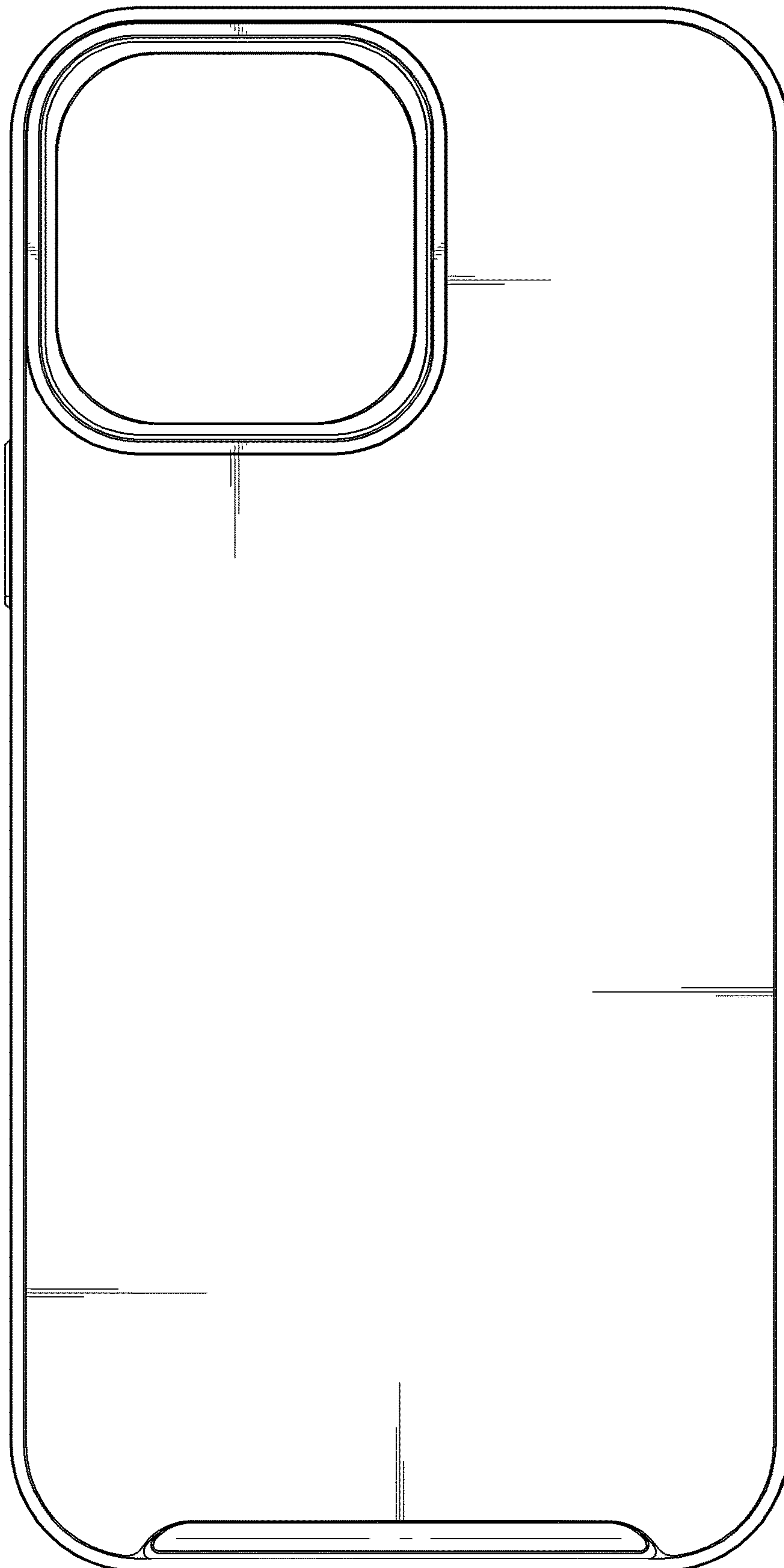

FIG. 14

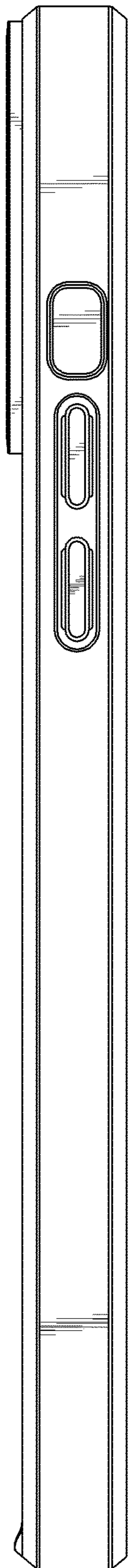

FIG. 15

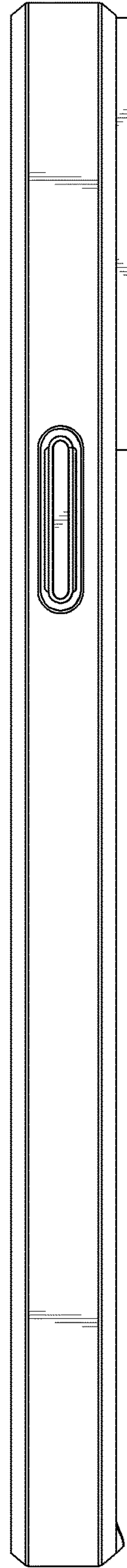



FIG. 16

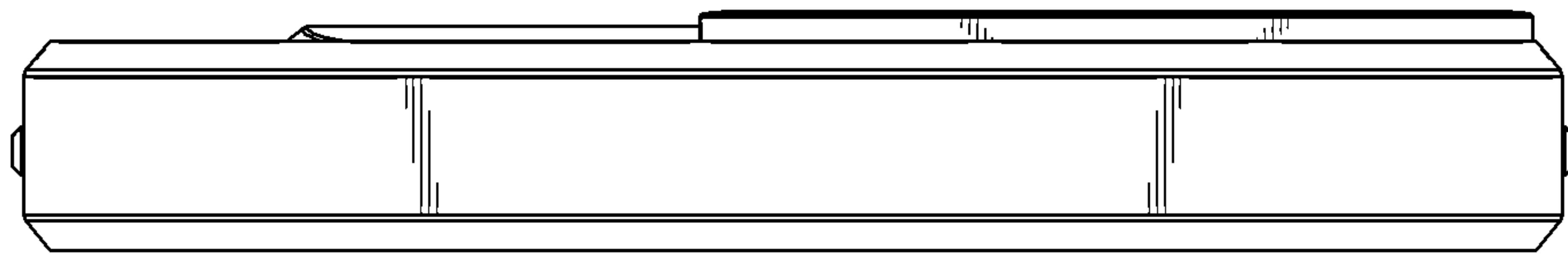

FIG. 17

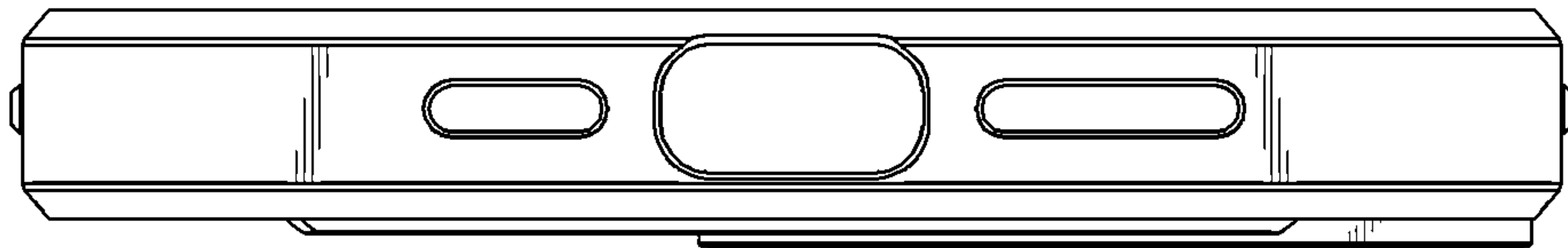

FIG. 18

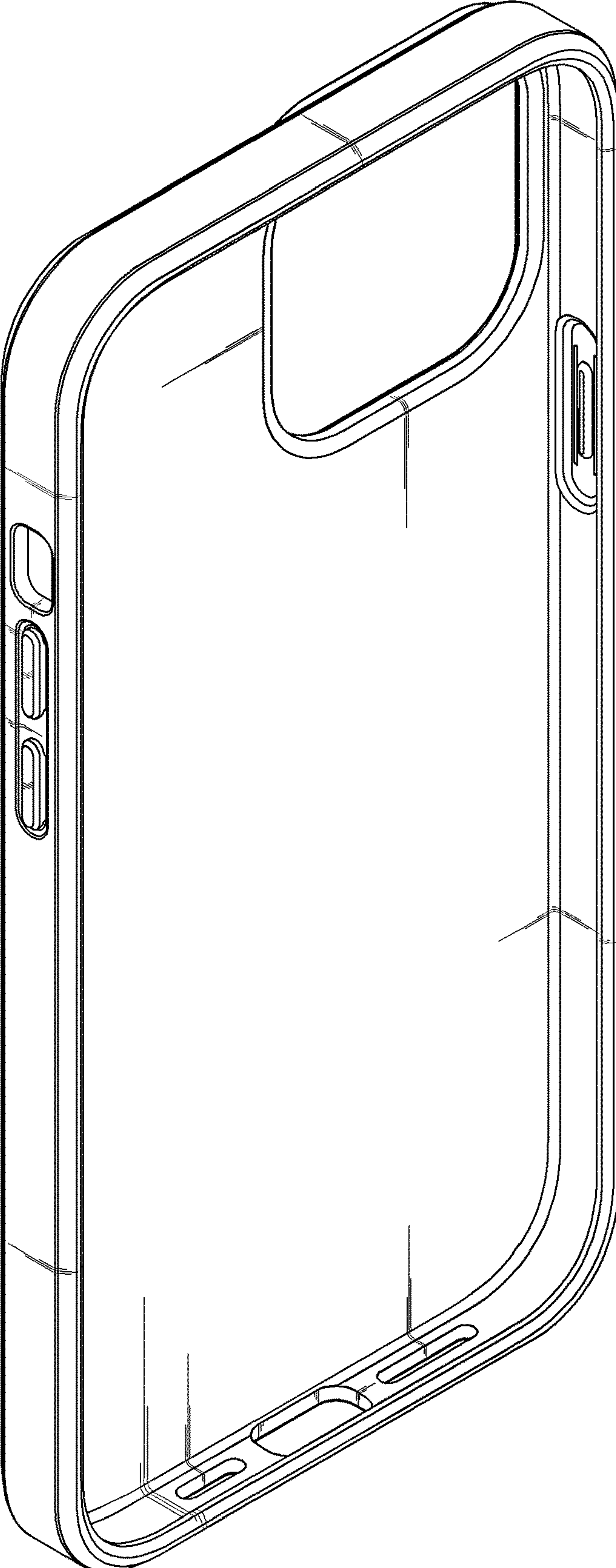

FIG. 19

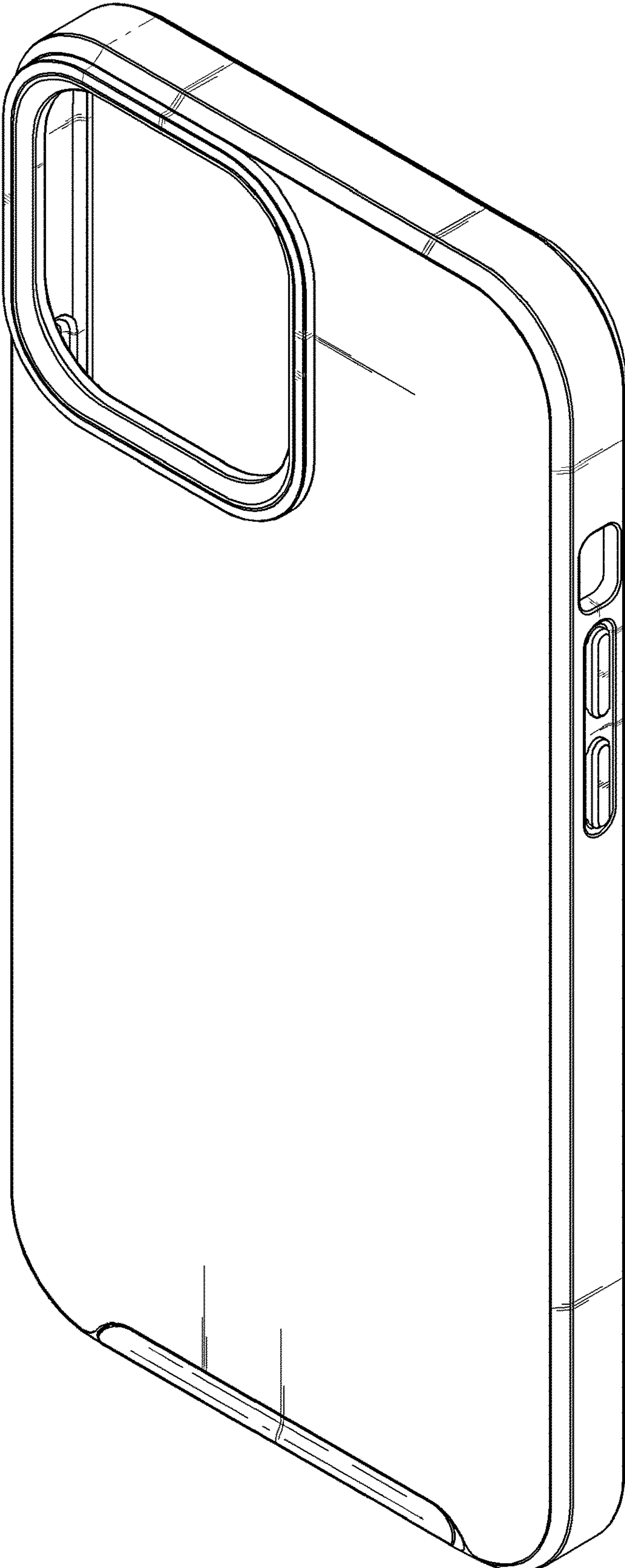

FIG. 20

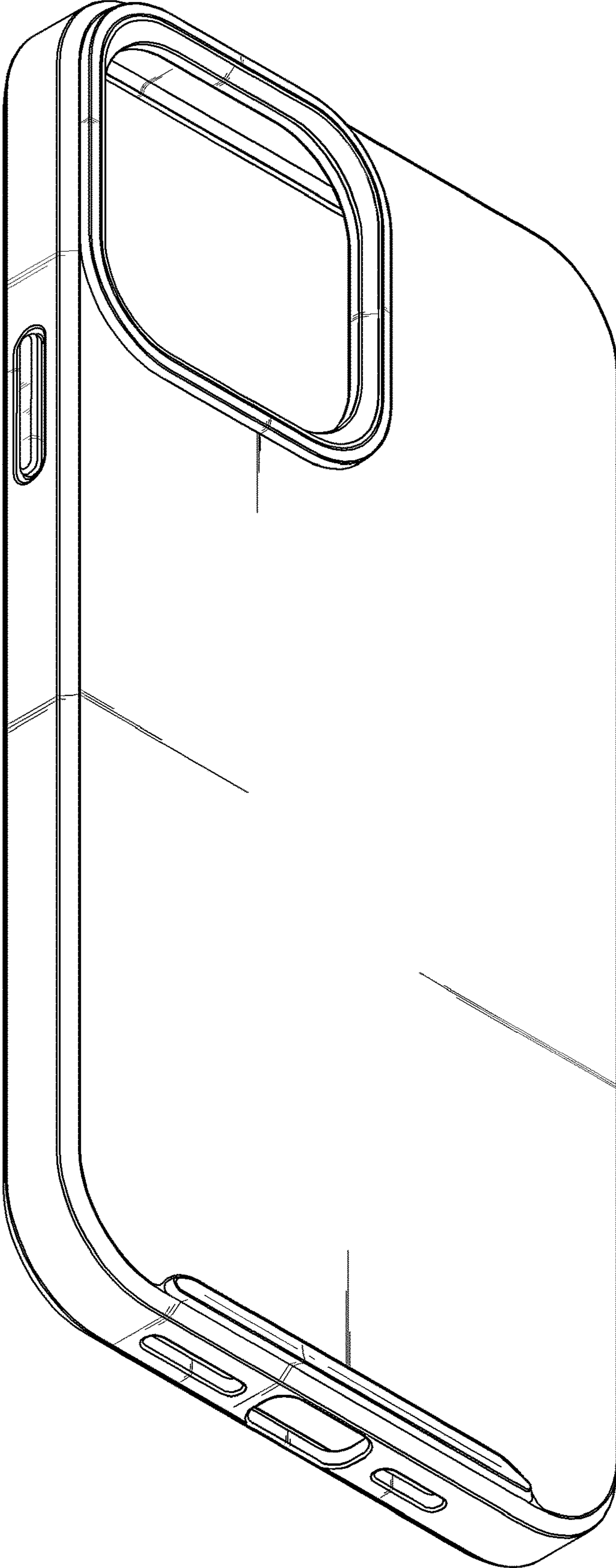

FIG. 21

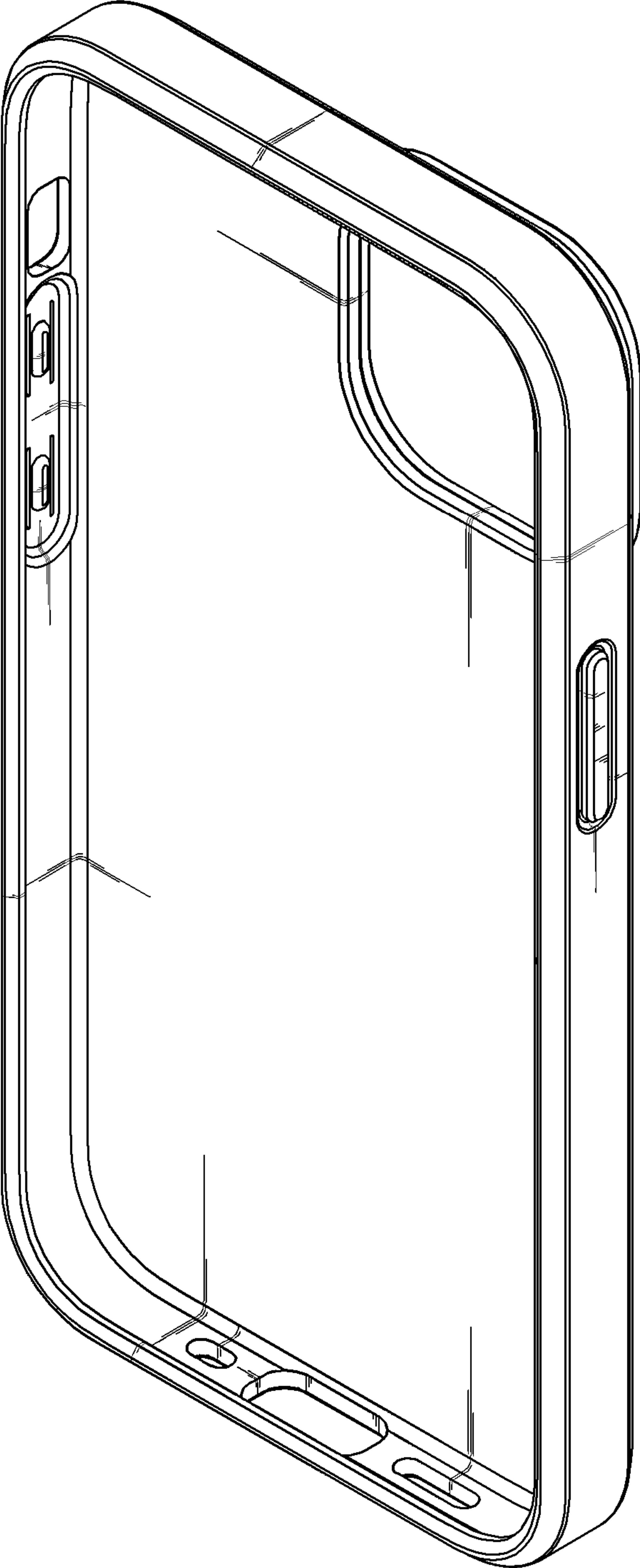

FIG. 22

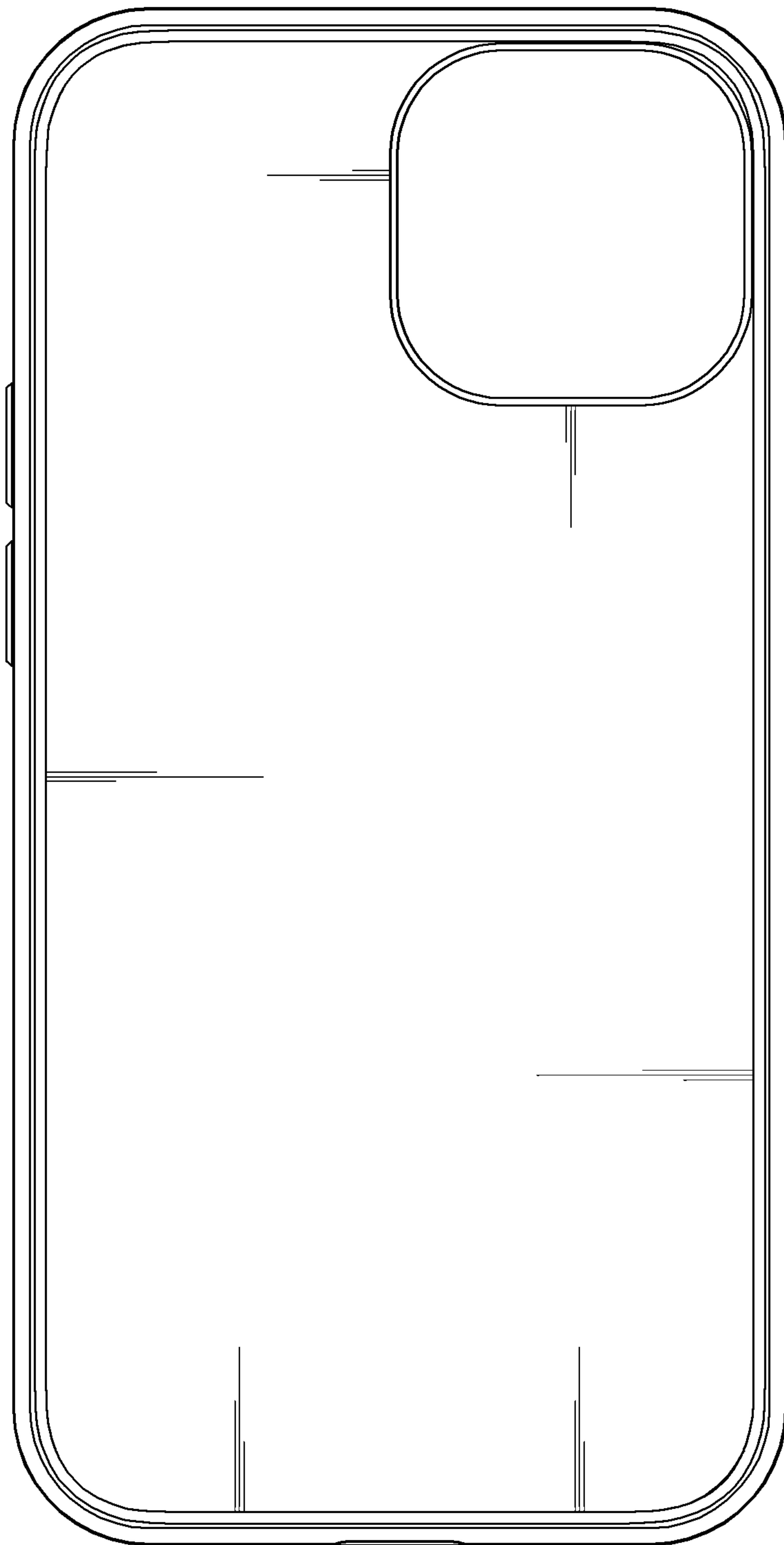



FIG. 23

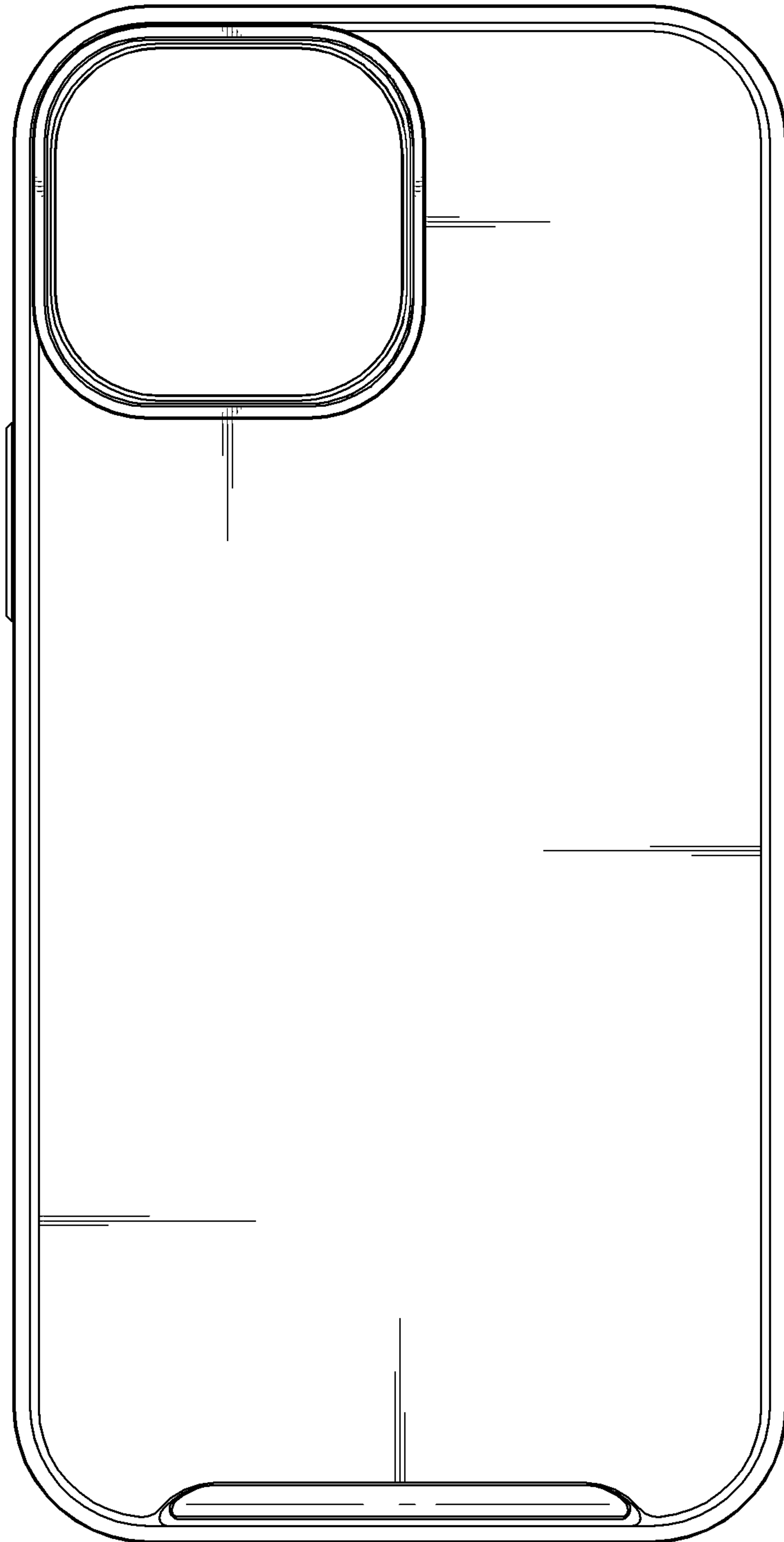

FIG. 24

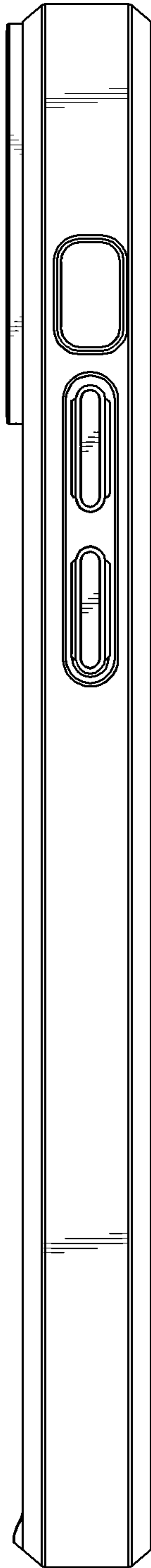

FIG. 25

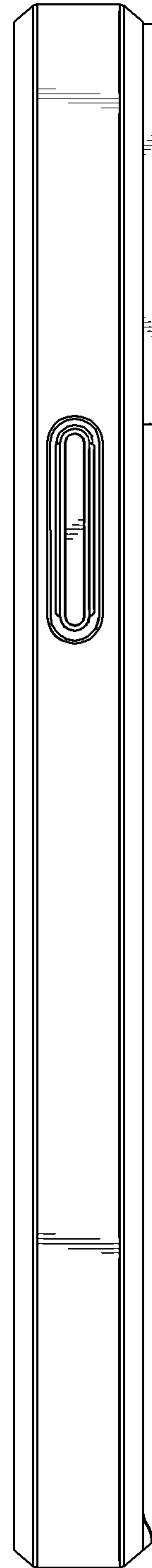

FIG. 26

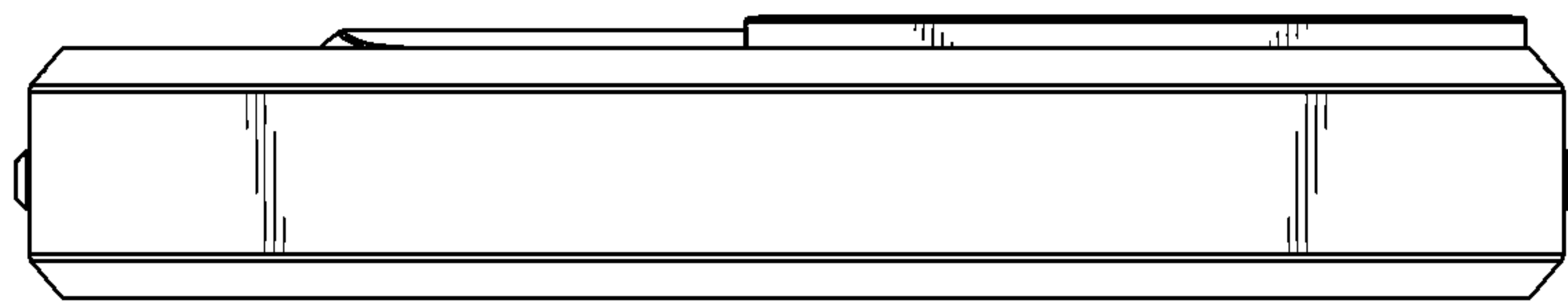

FIG. 27

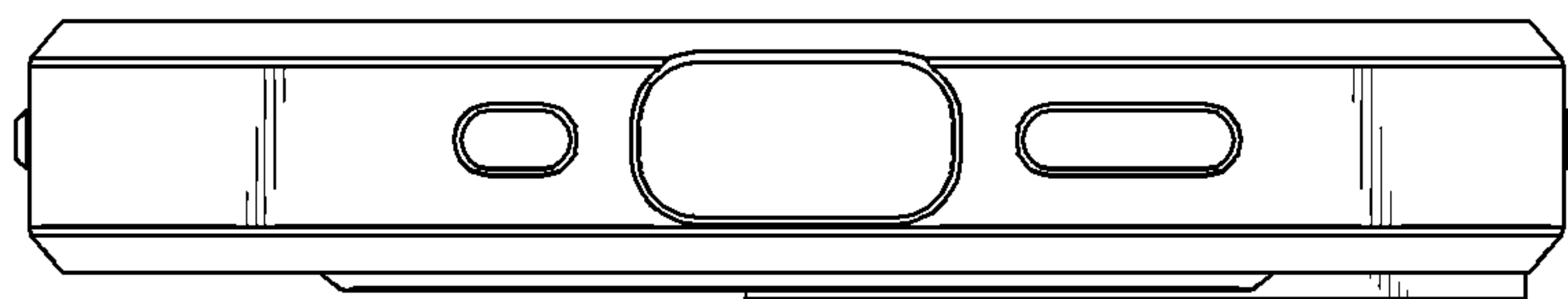

FIG. 28

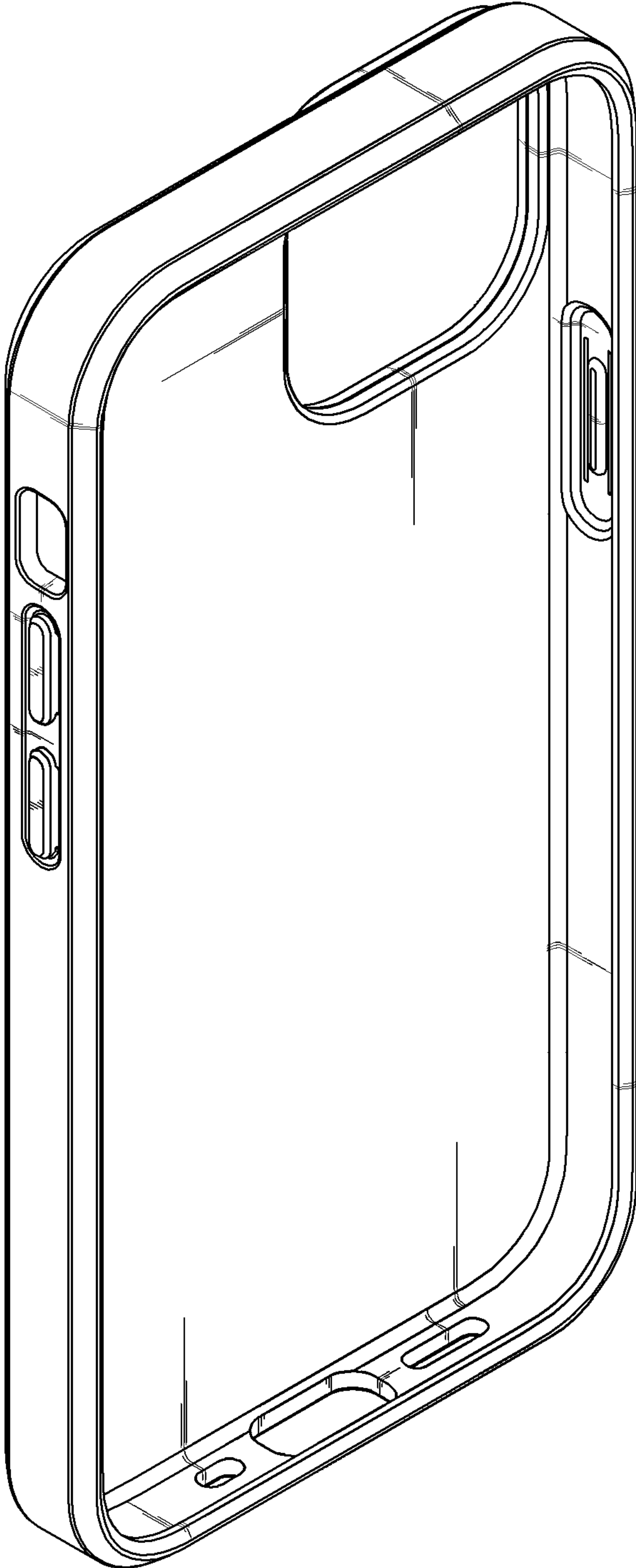

FIG. 29



FIG. 30

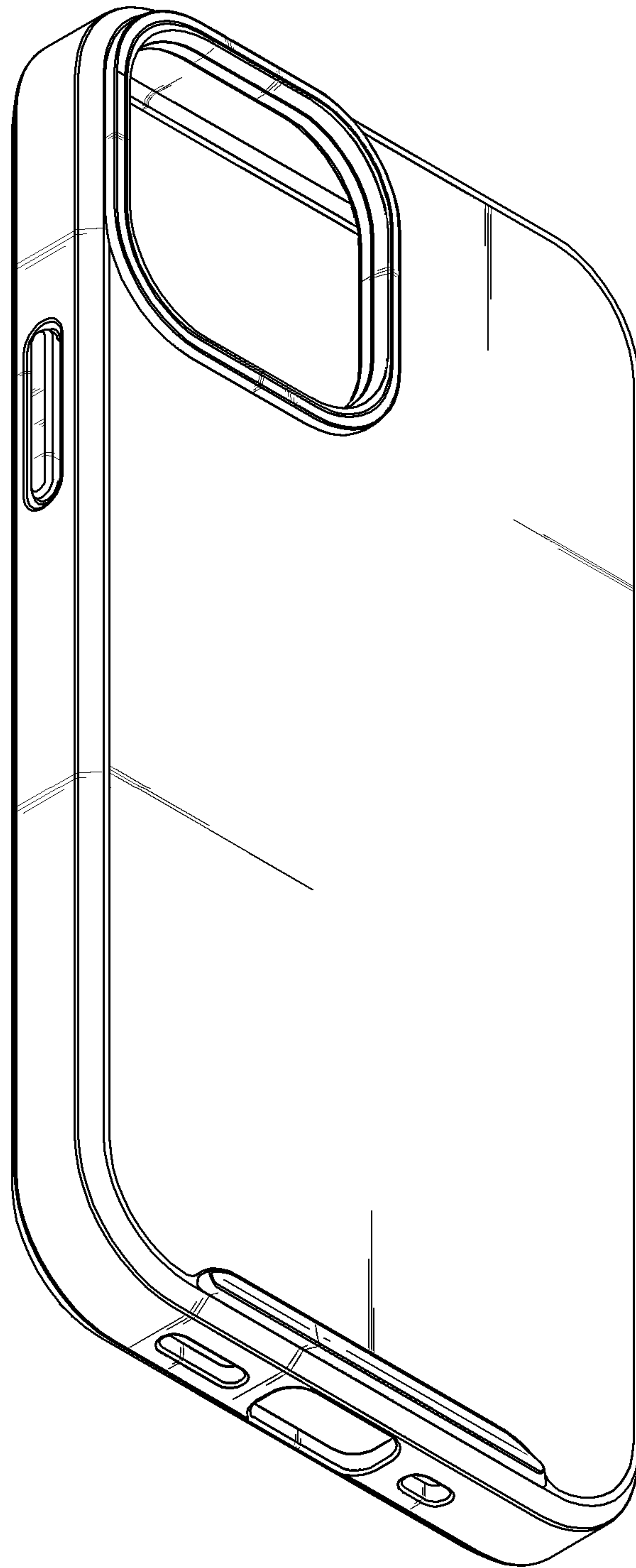



FIG. 31

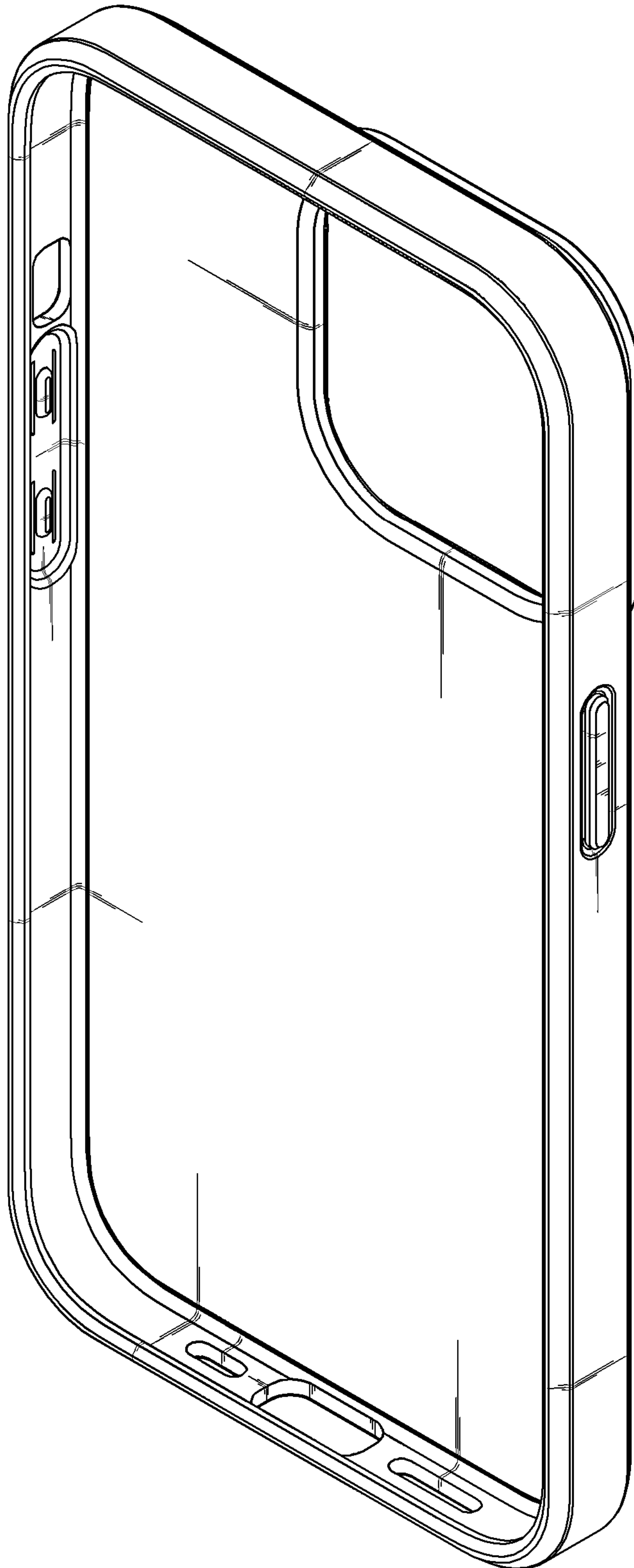

FIG. 32

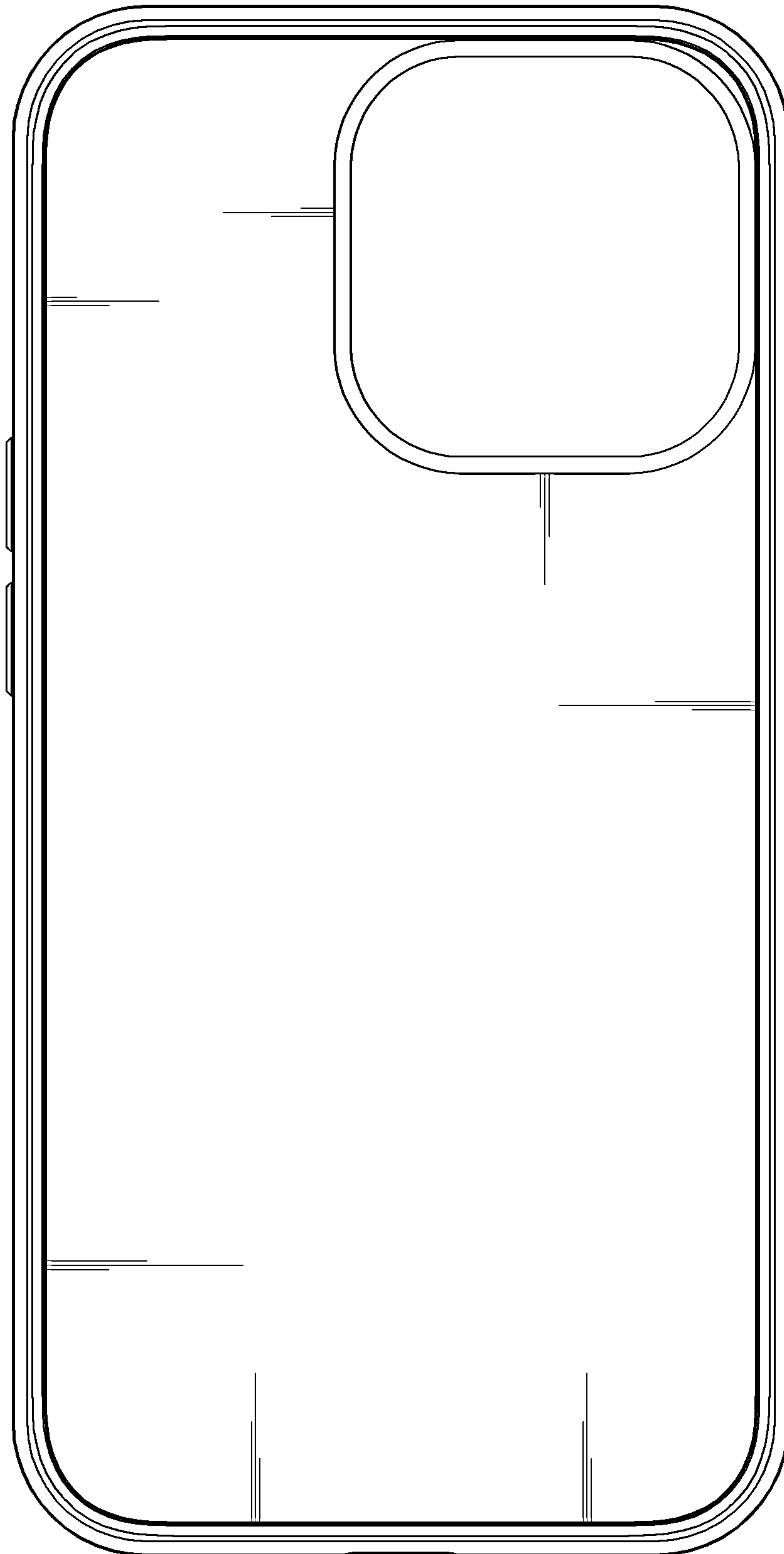

FIG. 33

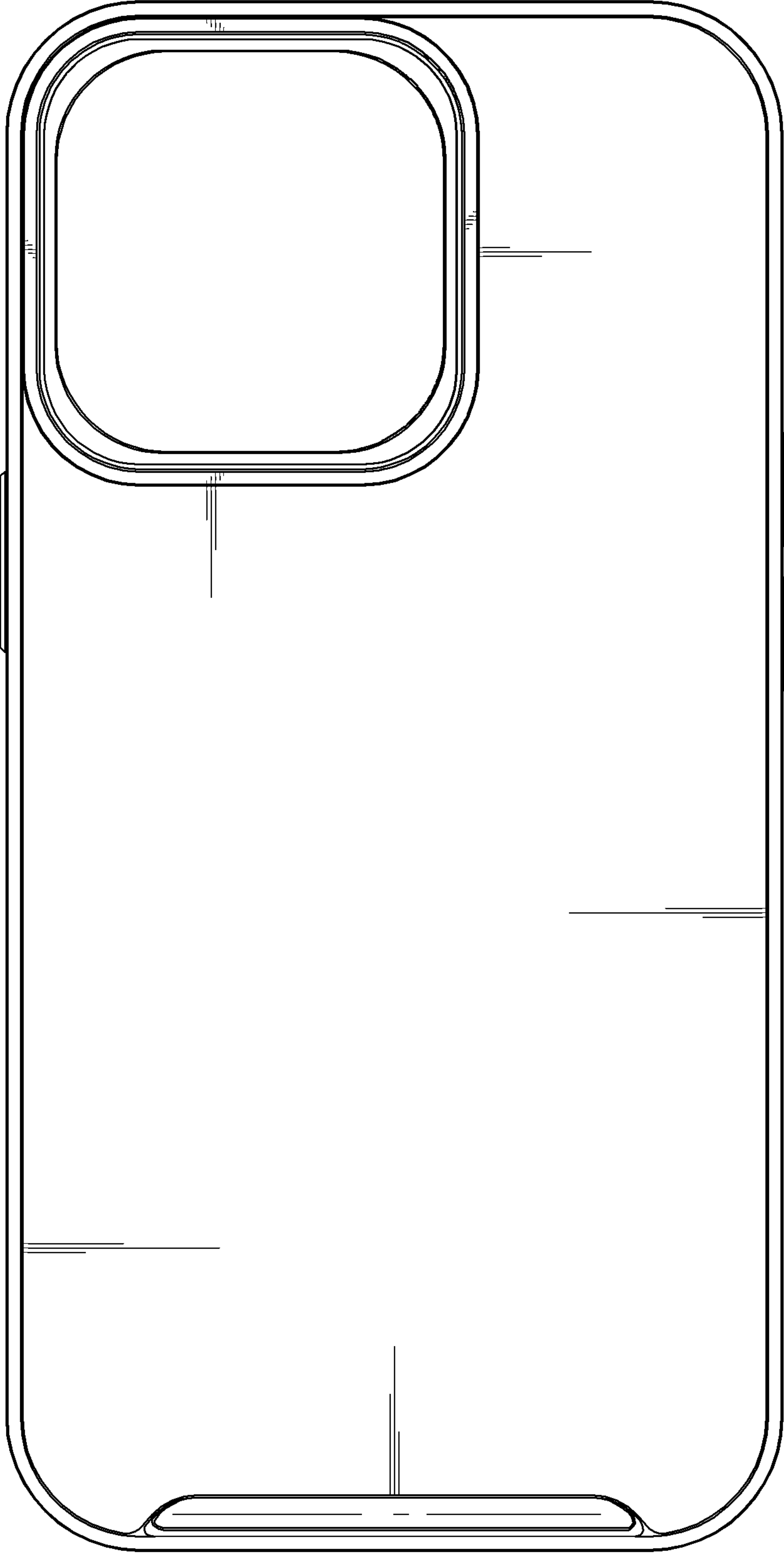

FIG. 34

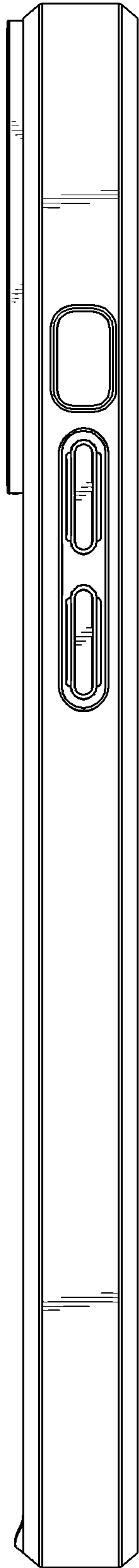

FIG. 35

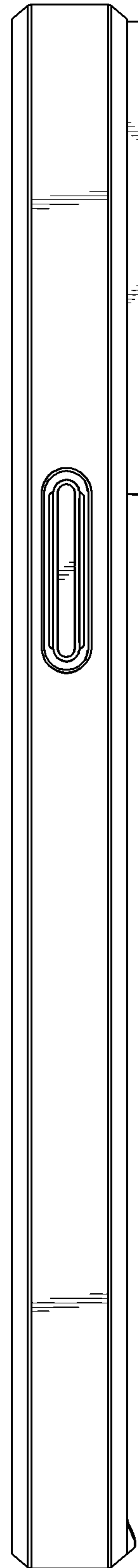

FIG. 36

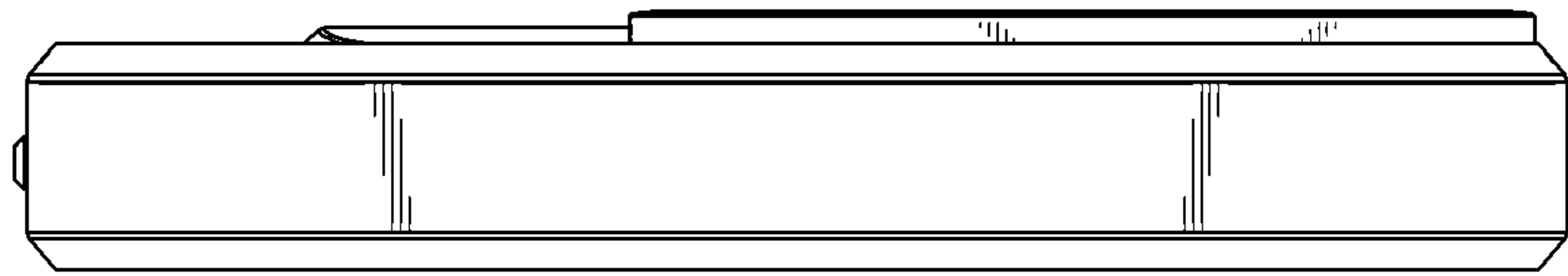

FIG. 37

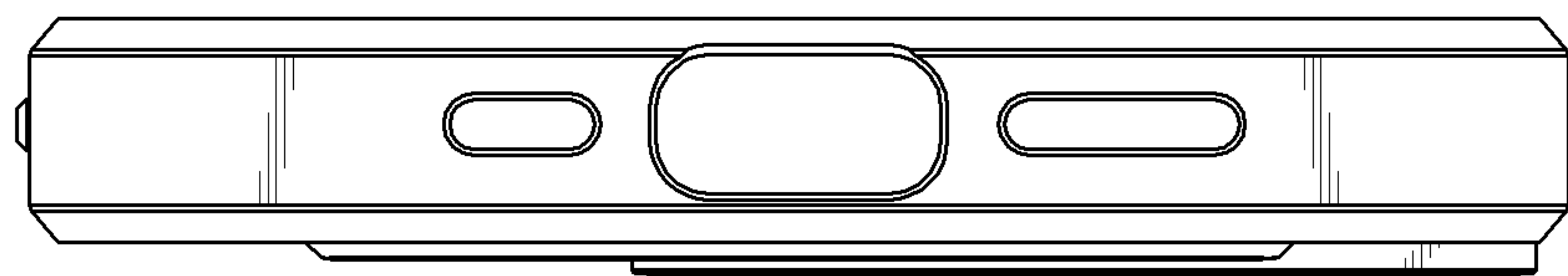

FIG. 38

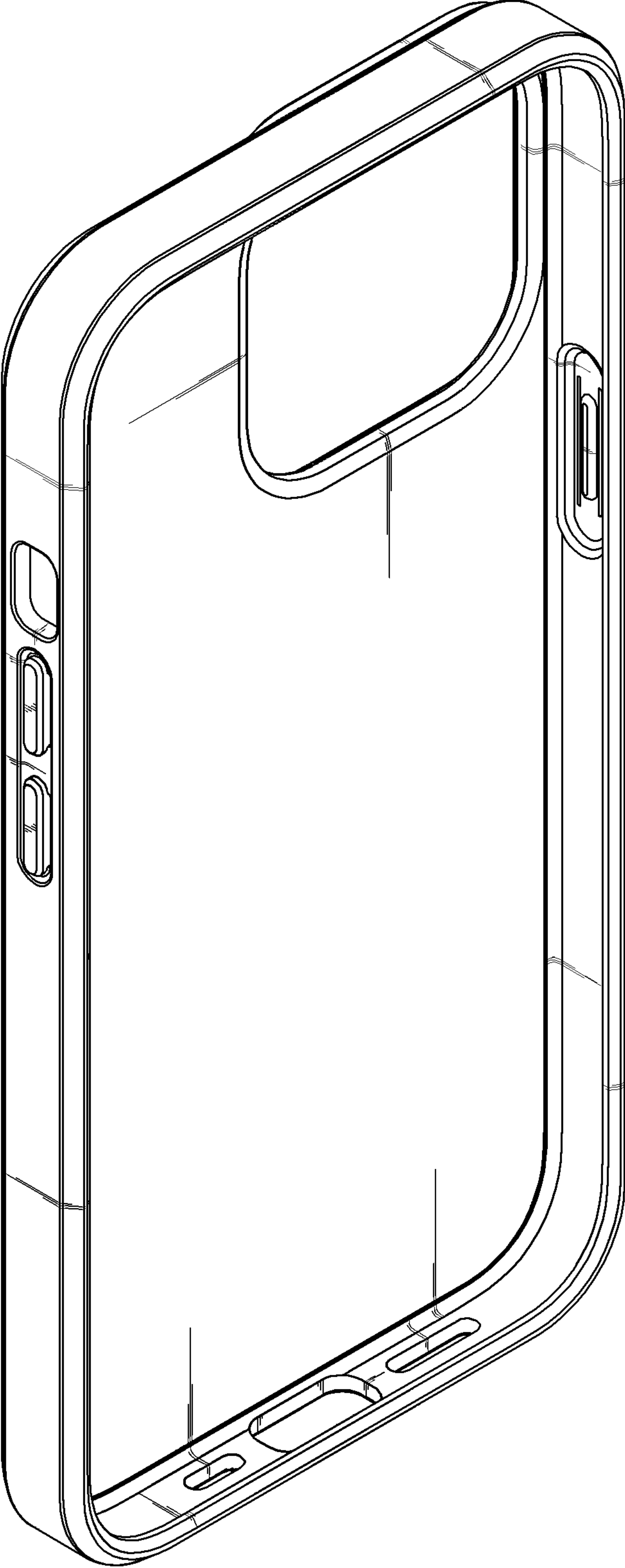



FIG. 39

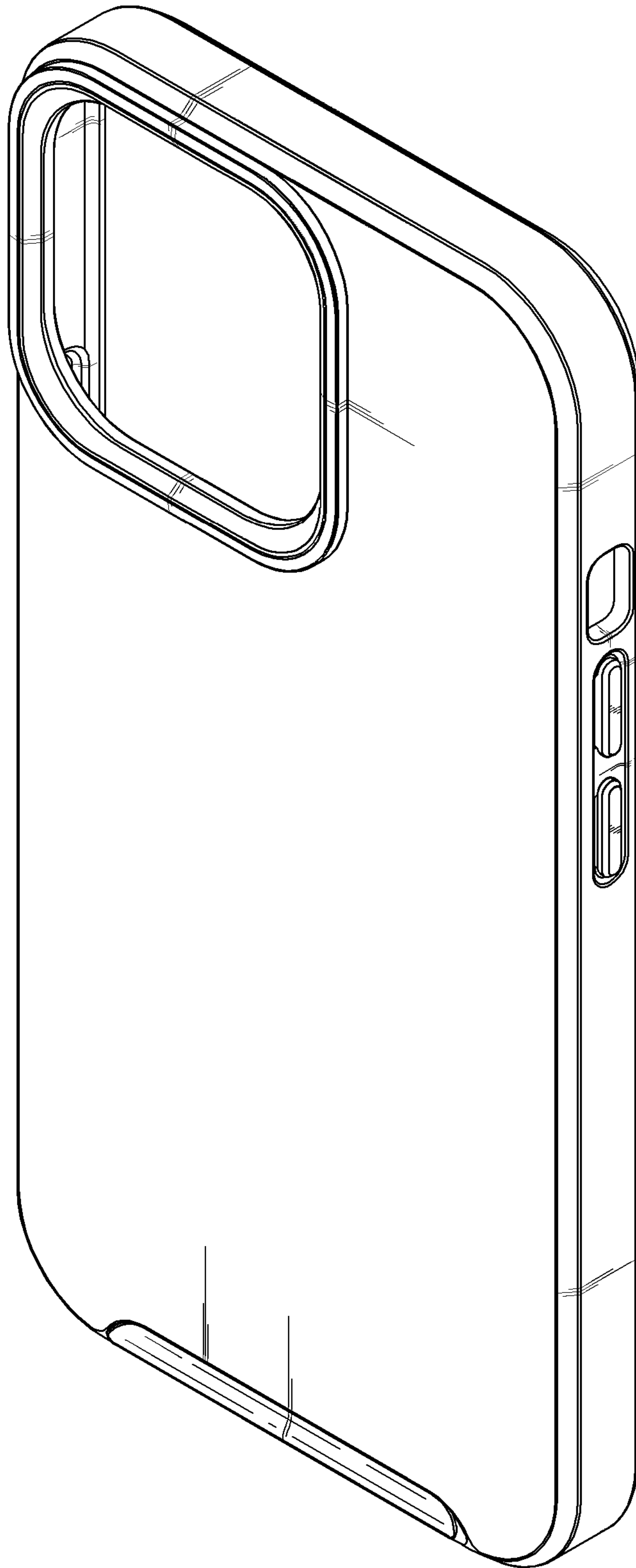

FIG. 40

